

# **ULTERRA® QUEST™**

**BOW-MOUNT TROLLING MOTOR**

Installation Instructions

# INTRODUCTION

## THANK YOU

Thank you for choosing Minn Kota. We believe that you should spend more time fishing and less time positioning your boat. That's why we build the smartest, toughest, most intuitive trolling motors on the water. Every aspect of a Minn Kota trolling motor is thought out and rethought until it's good enough to bear our name. Countless hours of research and testing provide you the Minn Kota advantage that can truly take you "Anywhere. Anytime." We don't believe in shortcuts. We are Minn Kota. And we are never done helping you catch more fish.

## REGISTRATION

Remember to keep your receipt and immediately register your trolling motor on our website at [minnkota.johnsonoutdoors.com/us/register](http://minnkota.johnsonoutdoors.com/us/register).

## SERIAL NUMBER

Your Minn Kota 11-character serial number is very important. It helps to determine the specific model and year of manufacture. When contacting Consumer Service or registering your product, you will need to know your product's serial number. A duplicate copy of your serial number label has been included, which can also be entered in the One-Boat Network App for future reference.

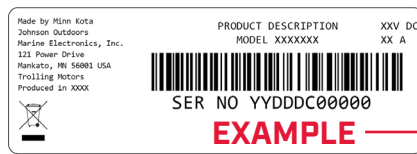
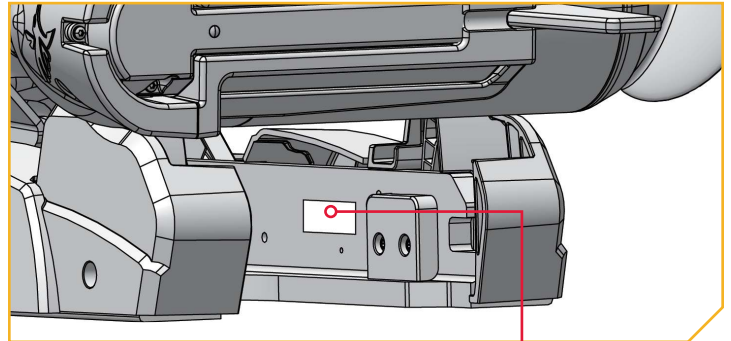

**NOTICE:** The serial number for the Ulterra QUEST is located on the inside of the Mount, behind the left Motor Ramp.

## MOTOR INFORMATION (For Consumer Reference Only)

Model: \_\_\_\_\_

Serial Number: \_\_\_\_\_

Purchase Date: \_\_\_\_\_

Store Where Purchased: \_\_\_\_\_

**NOTICE:** Do not return your Minn Kota motor to your retailer. Your retailer is not authorized to repair or replace this unit. You may obtain service by: calling Minn Kota at (800) 227-6433; returning your motor to the Minn Kota Factory Service Center; sending or taking your motor to any Minn Kota authorized service center. A list of authorized service centers is available on our website at [minnkota.johnsonoutdoors.com](http://minnkota.johnsonoutdoors.com). Please include proof of purchase, serial number and purchase date for warranty service with any of the above options.

Made for iPhone® 11 and iPhone X

For updated iOS, Humminbird® and Minn Kota® compatibility, visit [minnkota.johnsonoutdoors.com](http://minnkota.johnsonoutdoors.com)



Use of the Made for Apple badge means that an accessory has been designed to connect specifically to the Apple product(s) identified in the badge, and has been certified by the developer to meet Apple performance standards. Apple is not responsible for the operation of this device or its compliance with safety and regulatory standards. iPhone is a trademark of Apple Inc., registered in the U.S. and other countries. The trademark "iPhone" is used in Japan with a license from Aiphone K.K.

Android™ is a trademark of Google LLC. The Android robot is reproduced or modified from work created and shared by Google and used according to terms described in the Creative Commons 3.0 Attribution License.

# SAFETY CONSIDERATIONS

Please thoroughly read the user manual. Follow all instructions and heed all safety and cautionary notices. Use of this motor is only permitted for persons that have read and understood these user instructions. Minors may use this motor only under adult supervision.

## **WARNING**

You are responsible for the safe and prudent operation of your vessel. We have designed your Minn Kota product to be an accurate and reliable tool that will enhance boat operation and improve your ability to catch fish. This product does not relieve you from the responsibility for safe operation of your boat. You must avoid hazards to navigation and always maintain a permanent watch so you can respond to situations as they develop. You must always be prepared to regain manual control of your boat. Learn to operate your Minn Kota product in an area free from hazards and obstacles.

## **WARNING**

Never run the motor out of the water, as this may result in injuries from the rotating propeller. The motor should be disconnected from the power source when it is not in use or is off the water. When connecting the power-supply cables of the motor to the battery, ensure that they are not kinked or subject to chafe and route them in such a way that persons cannot trip over them. Before using the motor make sure that the insulation of the power cables is not damaged. Disregarding these safety precautions may result in electric shorts of battery(s) and/or motor. Always disconnect motor from battery(s) before cleaning or checking the propeller. Avoid submerging the complete motor as water may enter the lower unit through control head and shaft. If the motor is used while water is present in the lower unit considerable damage to the motor can occur. This damage will not be covered by warranty.

## **WARNING**

Take care that neither you nor other persons approach the turning propeller too closely, neither with body parts nor with objects. The motor is powerful and may endanger or injure you or others. While the motor is running watch out for persons swimming and for floating objects. Persons whose ability to run the motor or whose reactions are impaired by alcohol, drugs, medication, or other substances are not permitted to use this motor. This motor is not suitable for use in strong currents. The constant noise pressure level of the motor during use is less than 70dB(A). The overall vibration level does not exceed 2,5 m/sec<sup>2</sup>.

## **WARNING**

When stowing or deploying the motor, keep fingers clear of all hinge and pivot points and all moving parts. In the event of unexpected operation, remove power leads from the battery.

## **WARNING**

It is recommended to only use Johnson Outdoors approved accessories with your Minn Kota motor. Using non-approved accessories including to mount or control your motor may cause damage, unexpected motor operation and injury. Be sure to use the product and approved accessories, including remotes, safely and in the manner directed to avoid accidental or unexpected motor operation. Keep all factory installed parts in place including motor and accessory covers, enclosures and guards.

# KNOW YOUR BOAT

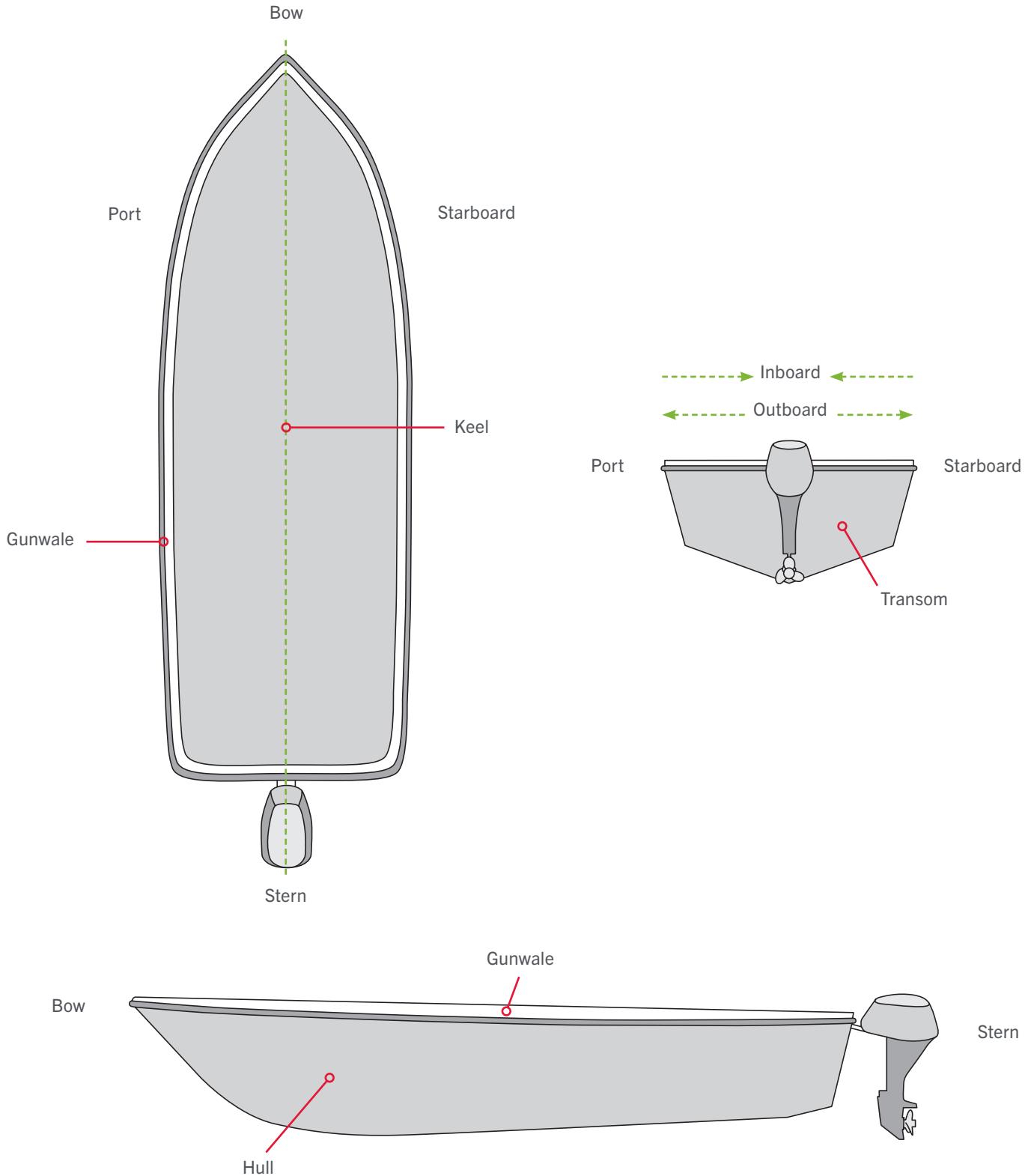

# INSTALLATION

## INSTALLING THE ULTERRA QUEST

Your new Ulterra QUEST comes with everything you'll need to install it directly to the boat. The motor can be mounted directly to the bow or coupled with a Minn Kota quick release bracket for ease of mounting and removal. For compatible quick release brackets and to locate your nearest dealer, visit [minnkota.johnsonoutdoors.com](http://minnkota.johnsonoutdoors.com). To install the motor directly to the boat, follow the instructions provided in this manual. Please review the parts list, mounting considerations and tools needed for installation prior to getting started. For additional product support, visit [minnkota.johnsonoutdoors.com](http://minnkota.johnsonoutdoors.com).

### INSTALLATION PARTS LIST

Item / Assembly	Part #	Description	Qty.
A (Includes 1-5)	2994948	BAG ASM, INSTINCT, T3 BL HDW	1
1	2323440	SCREW-3/8-16 X 2 1/2 HHCS SS	6
2	2383122	NUT 3/8-16 NYLON INST LOCKNUT	6
3	2321710	WASHER, RUBBER MOUNT	6
4	2371796	BACKUP BAR 3/16 X 1 X 2	6
5	2378608	ANTI SEIZE TUBE, 4CC, TALON	1
6	✘	MOTOR ASSEMBLY	1
7	2390802	LANYARD w/CARABINER IP RMT U2	1
8	411690-1	TROLLING MOTOR REMOTE	1
9	2992371	STABILIZER, BWMT ES TM ASM *72**	1
10	2321170	PROP, POWER REAMED	1
B (Includes 11-13)	2992604	BAG ASSM, PROP HARDWARE	1
11	2091701	WASHER-PROP (LARGE) MAX101	1
12	2093101	NUT-PROP, NYLOC, LG, MX101 3/8 SS	1
13	2262659	PIN-DRIVE 1" X 3/16 SS 17-4	1
C	2994742	FT PED ASM, ULTERRA QUEST	1
D (Includes 14)	2994859	BAG ASY-TERROVA/V2, RUB. BUMPERS	1
14	2325110	PAD, FOOT PEDAL PD	5
15	490637-4	CABLE, ETH, M12-M12, BRAID, 30'	1
16	490380-1	CABLE, ETHERNET PIGTAIL-700 HD	1
17	2206301	TIE WRAP, LOW PROFILE 8"	1
18	2994961	BAG ASM, CABLE, ADPTR, 490537-2 *490537-2* *MKR-MI-1* *DSC* *MSI*	1
E (Includes 19)	2994955	BAG ASM, MKA-60 STABILIZER *72**	1
19	2383475	SCREW-#8-18x1 1/2 L SELF DRILL SS *72**	4
▲	2207124	MANUAL, ULTERRA	1
▲	2207125	MANUAL, INSTL GD, ULTERRA	1
▲	2207126	QK REF GUIDE, ULT Q/INST Q	1
▲	2397110	MANUAL, WIRELESS REMOTE	1
▲	2397115	GUIDE-QCK REFERENCE IP 4.0	1
▲	2294950	INSTRUCTIONS, OBN & REMOTE PAIR	1
▲	2207130	BRUSHLESS QS SETUP GUIDE	1
▲	2377179	INSTR. SHEET, MKA-60 STBLZR *72**	1

▲ Not shown on Parts Diagram.

✘ This part is included in an assembly and cannot be ordered individually.

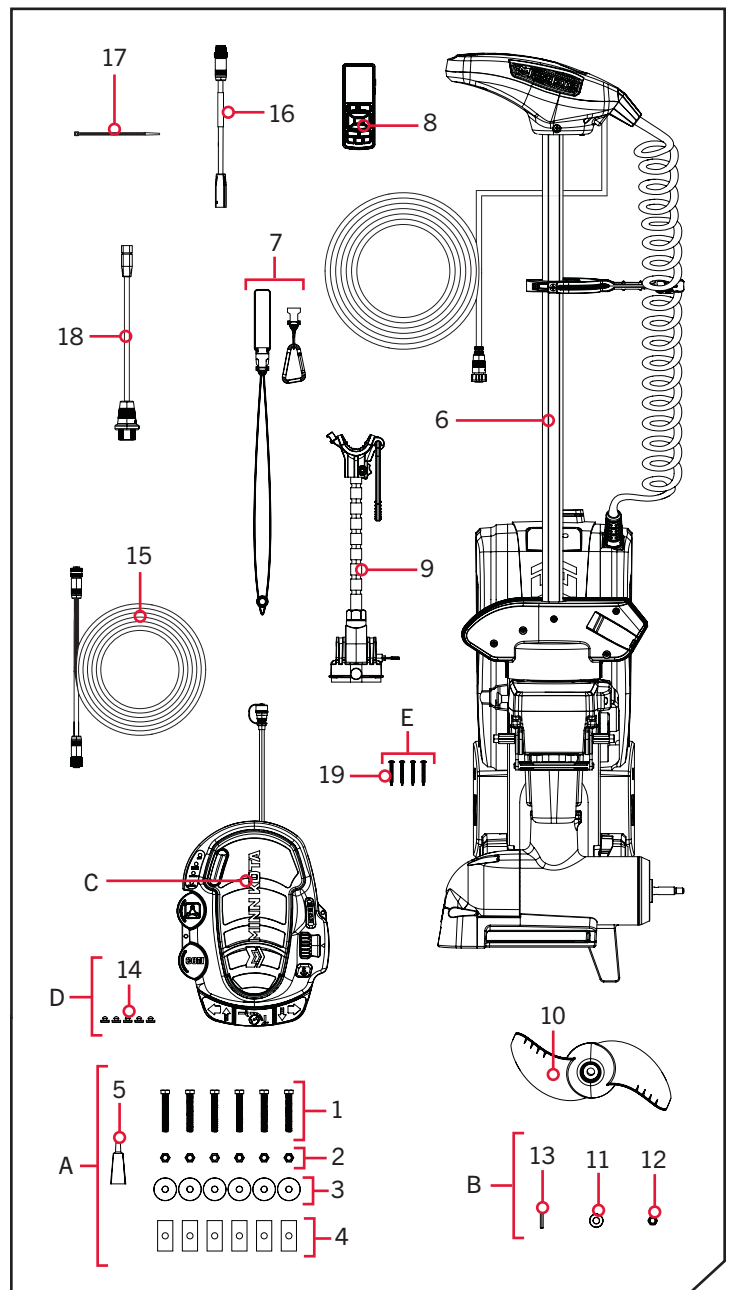

# MOUNTING CONSIDERATIONS

## MOUNTING CONSIDERATIONS

It is recommended that the motor be mounted as close to the centerline or keel of the boat as possible. Make sure the area under the mounting location is clear to drill holes and install hardware. The mounting surface for the Ulterra QUEST must be flat. Rubber washers can be used to shim the base extrusion flat before hardware is tightened.

The motor must not encounter any obstructions as it is lowered into the water or raised into the boat when stowed and deployed. When stowed, ensure that there is enough room for the Shaft and Control Head and that they do not extend off the side of the boat.



View accessories available for your trolling motor at [minnkota.johnsonoutdoors.com](http://minnkota.johnsonoutdoors.com).

All six mounting holes must be used when securing the Ulterra QUEST to the boat deck. If the desired mounting location does not allow for all six mounting holes and mounting bolts, a Boat Deck Reinforcement Kit (1854058) should be used or a new mounting location selected. Consider a quick release bracket with the installation of your motor.

Mounting options for the Ulterra QUEST include:

1. Installing the motor directly to the boat deck
2. Mounting the motor with an MKA-58 Boat Deck Reinforcement Kit (1854058)
3. Mounting the motor with an MKA-56/RTA-55 composite quick release bracket (1854056 - black/1854055 - white) or an MKA-57 sliding quick release bracket (1854057)
4. Combining an MKA-58 Boat Deck Reinforcement Kit and an MKA-56/RTA-55 Quick Release Bracket with the Ulterra QUEST

When mounting the Ulterra QUEST directly to the boat, follow the installation instructions outlined in this manual. If an accessory bracket will be used to mount the Ulterra QUEST, follow the installation instructions provided with the mounting accessory. To view a list of compatible accessories, visit [minnkota.johnsonoutdoors.com](http://minnkota.johnsonoutdoors.com).

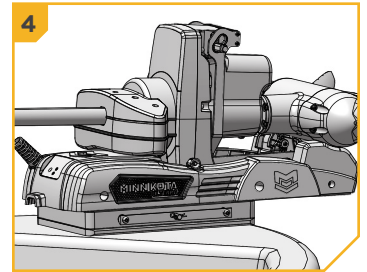
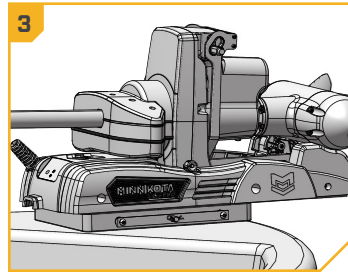
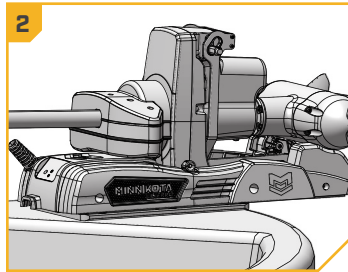
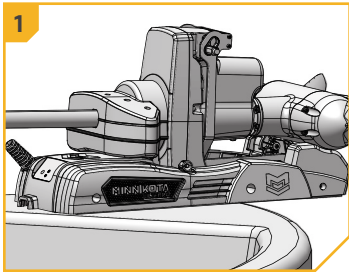

## TOOLS AND RESOURCES REQUIRED

- #3 Phillips Screwdriver
- Drill
- 3/8" Drill Bit
- Awl or similar marking tool
- 9/16" Open/Box End Wrench
- 9/16" Deep Well Socket
- A second person to help with the installation

# INSTALLING THE ULTRERA QUEST

## INSTALLATION >

### INSTALLING THE ULTRERA QUEST

1

#### ITEM(S) NEEDED

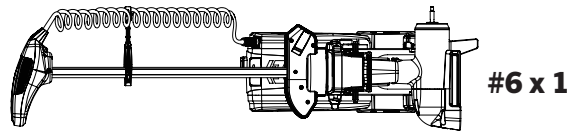

- Place the trolling motor (Item #6) on an elevated, level surface, such as a workbench or the tailgate of a pickup. The motor, as removed from the box, should be in the stowed position.
- Make sure that the Power Cables from the battery are disconnected or that the breaker, if equipped, is "off."

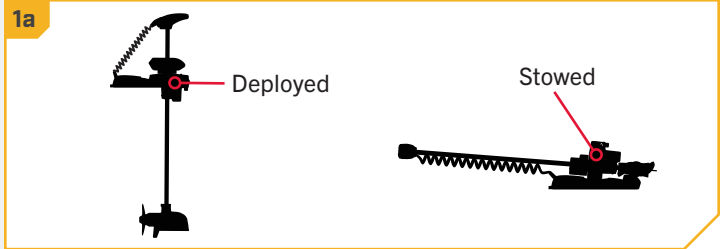

## WARNING

Make sure the motor is on a level surface and is not connected to a power source.

**NOTICE:** The trolling motor weighs up to 90lb. Minn Kota recommends having a second person help with the installation.

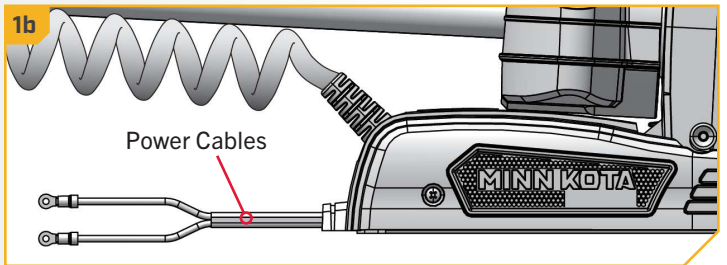

2

- Remove the four Sideplate Screws using a #3 Phillips Screwdriver. Two of these screws will be located on each side of the mount.
- Remove the Right Sideplate and the Left Sideplate to expose the six mounting holes in the Base Extrusion.

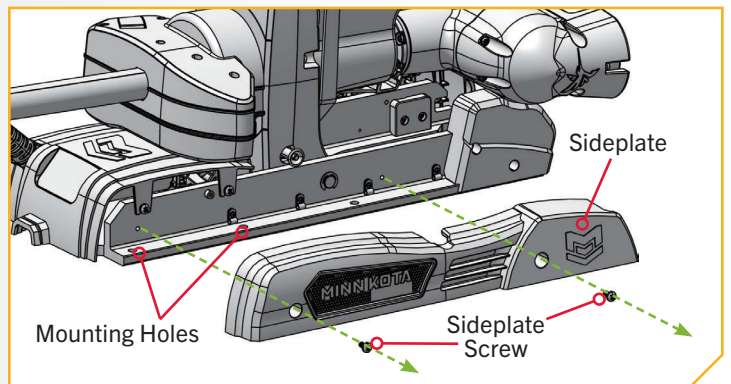

# INSTALLING THE ULTERRA QUEST

3

- e. Review the mounting considerations at the beginning of the Installation section for proper clearance. Place the motor on the bow of the boat at the intended mounting location, as close to the centerline or keel as possible. Ensure there is enough room for the Shaft and Control Head and that they do not extend off the side of the boat. The motor can be installed on either the Port or Starboard side of the bow, based on personal preference.
- f. Position the motor so that the Slot in the Base Extrusion is positioned beyond the boat Gunwale. For proper clearance, the entire Slot must be visible beyond the Gunwale. When the motor is deployed, there must be a minimum required distance of 1½" between the Gunwale and the bottom of the Steering Housing and Shaft.

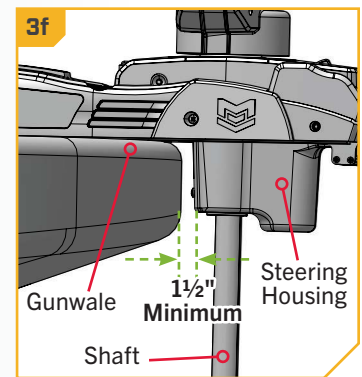
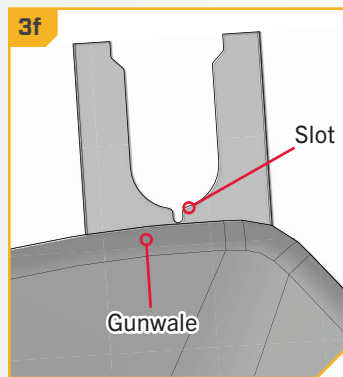
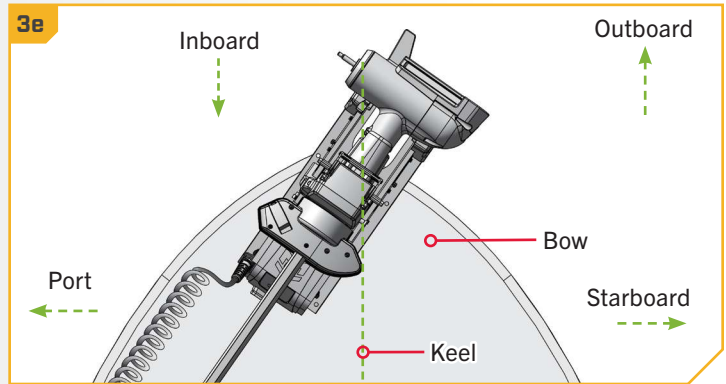

**CAUTION**

Illustrations are for reference only. Do not deploy the motor until it is fully mounted to the boat. Deploying the motor before it is mounted to the boat may cause injury.

- g. When mounting the Ulterra QUEST, all six mounting holes must be used. If the desired mounting location does not allow for all six mounting holes, a Boat Deck Reinforcement Kit (1854058) should be used or a new mounting location selected.

4

- h. With the motor at the intended mounting location, take an Awl or similar tool and mark all six mounting holes in the Base Extrusion.
- i. Slide the motor aside to drill the mounting holes. Drill through the boat deck using a Drill and a 3/8" Drill Bit on all six marked locations.
- j. Reposition the motor over the drilled holes to install mounting hardware.

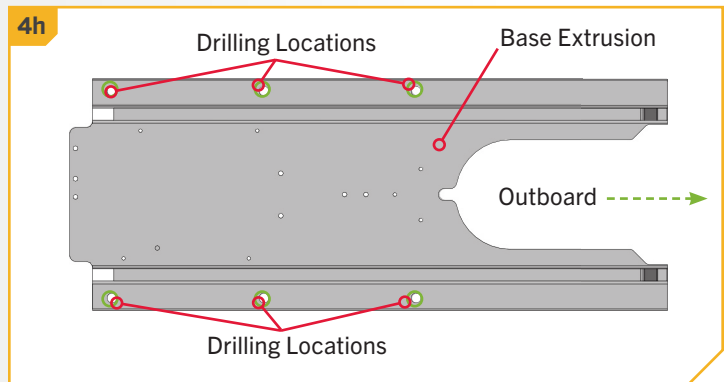

**NOTICE:** New mounting holes are required when upgrading from an Ulterra to an Ulterra QUEST. New mounting holes will accommodate the higher thrust motor and ensure the installation is secure.

**NOTICE:** The mounting surface for the Ulterra QUEST must be flat. Rubber Washers can be used to shim the Base Extrusion flat before hardware is tightened.



# INSTALLING THE ULTRERA QUEST

5

## ITEM(S) NEEDED



#1 x 6

Nylock Nut #2 x 6



#3 x 6



#4 x 6



#5 x 1

**NOTICE:** To prevent seizing of the stainless steel hardware, do not use high-speed installation tools. Wetting the screws or applying an anti-seize (Item #5) may help prevent seizing.

- k. Take six Hex Head Cap Screws (Item #1) and apply anti-seize (Item #5) to each Screw. Insert the Screws through the Base Extrusion and into each of the drilled locations. If Rubber Washers (Item #3) are used, the Rubber Washers should sit between the Base Extrusion and boat deck.
- l. Place a Backup Bar (Item #4) and then a Nylock Nut (Item #2) on the end of each Screw. Tighten with a 9/16" Box End or Open End Wrench. Make sure all hardware is secure.

**NOTICE:** Use extra care to avoid pinching and damaging the sensor wires that run alongside the Base Extrusion when installing and tightening the mounting hardware.

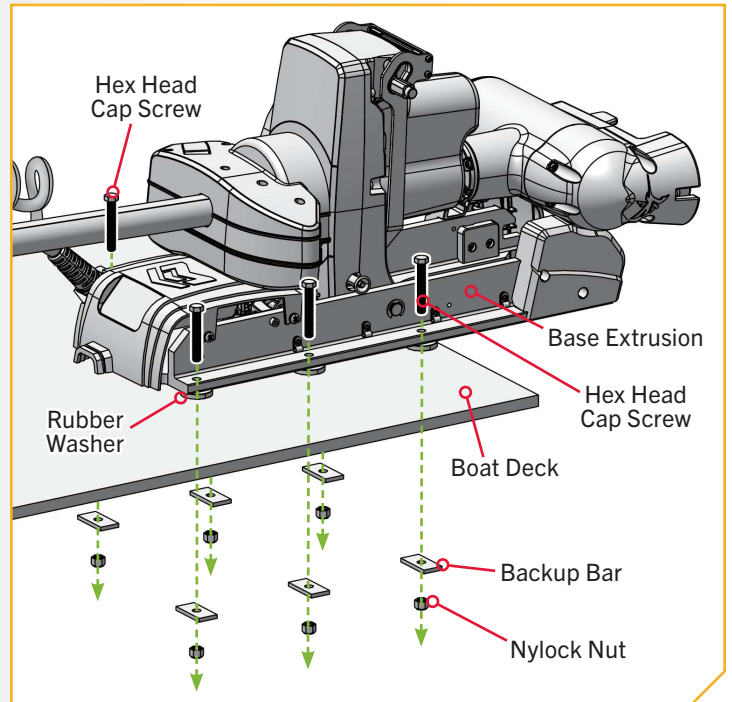

6

- m. Replace the Right Sideplate and Left Sideplate. Replace the four Sideplate Screws using a #3 Phillips Screwdriver. Two of these screws will be located on each side of the mount.

**NOTICE:** When reinstalling the Sideplates, use care to avoid pinching the sensor wires that run alongside the Base Extrusion.

**NOTICE:** Ensure that the area between the Mount and Steering Housing is clean and free of debris and that no installation hardware has fallen in. The Mount contains a Stow Pad that contacts the Steering Housing when stowed. The motor cannot stow securely if an obstruction is present on the Stow Pad.

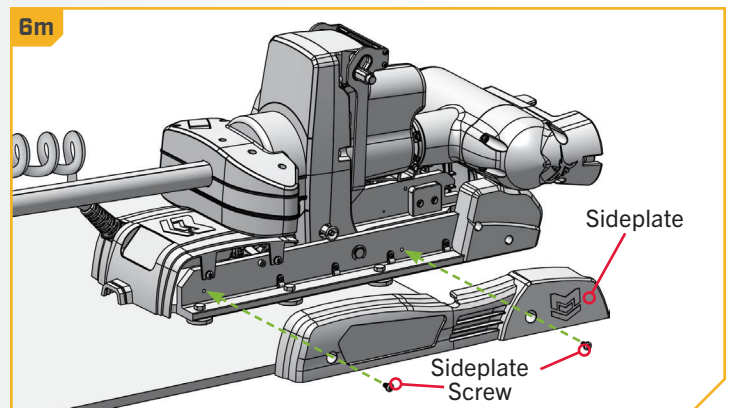

# BATTERY & WIRING INSTALLATION

## BOAT RIGGING & PRODUCT INSTALLATION

For safety and compliance reasons, we recommend that you follow American Boat and Yacht Council (ABYC) standards when rigging your boat. Altering boat wiring should be completed by a qualified marine technician. The following specifications are for general guidelines only:

### CAUTION

These guidelines apply to general rigging to support your Minn Kota motor. Powering multiple motors or additional electrical devices from the same power circuit may impact the recommended conductor gauge and circuit breaker size. If you are using wire longer than that provided with your unit, follow the conductor gauge and circuit breaker sizing table below. If your wire extension length is more than 25 feet, we recommend that you contact a qualified marine technician.

### CAUTION

**An over-current protection device (circuit breaker or fuse) must be used.** Coast Guard requirements dictate that each ungrounded current-carrying conductor must be protected by a manually reset, trip-free circuit breaker or fuse. The type (voltage and current rating) of the fuse or circuit breaker must be sized accordingly to the trolling motor used. The table below gives recommended guidelines for circuit breaker sizing.

## CONDUCTOR GAUGE AND CIRCUIT BREAKER SIZING TABLE

This conductor and circuit breaker sizing table is only valid for the following assumptions:

1. No more than 2 conductors are bundled together inside of a sheath or conduit outside of engine spaces.
2. Each conductor has 105° C temp rated insulation.
3. No more than 3% voltage drop allowed at full motor power based on published product power requirements.

Motor Thrust / Model	Max Amp Draw	Circuit Breaker		Wire Extension Length				
		Amps	Minimum	5 feet	10 feet	15 feet	20 feet	25 feet
QUEST 24V	60	60 Amp	24 VDC	6 AWG	6 AWG	4 AWG	4 AWG	2 AWG
QUEST 36V	60	60 Amp	36 VDC	6 AWG	6 AWG	6 AWG	6 AWG	4 AWG

**NOTICE:** Wire Extension Length refers to the distance from the batteries to the trolling motor leads. Consult website for available thrust options.

Reference

United States Code of Federal Regulations: 33 CFR 183 – Boats and Associated Equipment ABYC E-11: AC and DC Electrical Systems on Boats

# SELECTING THE CORRECT BATTERIES

## SELECTING THE CORRECT BATTERIES

QUEST series motors will operate with any deep cycle marine 12, 24 or 36-volt battery/batteries and have been optimized for use with LiFePO<sub>4</sub> lithium-ion battery cells. Lithium-ion batteries maintain higher voltages for more extended periods than lead-acid batteries and will provide the best performance in powering the trolling motor.

QUEST series trolling motors may also be powered with lead-acid (flooded, AGM, or GEL) deep-cycle marine 12-volt battery/batteries. For best results, Minn Kota recommends using a deep-cycle marine battery with rating outlined in the "Deep Cycle Amp-Hour Rating" table. Maintain lead-acid batteries at full charge. Proper care will ensure battery power when needed and significantly improve battery life. Failure to recharge lead-acid batteries (within 12-24 hours) is the leading cause of premature battery failure. Use a multi-stage charger to avoid overcharging. When using Lithium Ion batteries, manufacturers may recommend storing in a semi-charged state and charging fully prior to use.

Deep Cycle Amp-Hour Rating			
Run Time	Voltage	Group Size	Amp-Hour
GOOD	12	24	70-85
BETTER	12	27	85-110
BEST	12	31	95-125

If using a crank battery to start a gasoline outboard, Minn Kota recommends using a separate battery/batteries for your Minn Kota trolling motor. Always check with the battery manufacturer for specific maintenance, care and storage instructions. Minn Kota also offers a wide selection of chargers to fit your charging needs. For more information on battery selection, rigging, and chargers, please visit [minnkota.johnsonoutdoors.com](http://minnkota.johnsonoutdoors.com).

### **WARNING**

Never connect the (+) and the (-) terminals of the same battery together. Take care that no metal object can fall onto the battery and short the terminals. This would immediately lead to a short and extreme fire danger.

### **CAUTION**

Refer to "Conductor Gauge and Circuit Breaker Sizing Table" in the previous section to find the appropriate circuit breaker or fuse for your motor. For motors requiring a 60-amp breaker, the Minn Kota MKR-27 60-amp circuit breaker (1865115) is recommended.

### **CAUTION**

Please read the following information before connecting your motor to your batteries in order to avoid damaging your motor and/or voiding your warranty.

## ADDITIONAL CONSIDERATIONS

### › Using DC or Alternator Chargers

Your Minn Kota trolling motor may be designed with an internal bonding wire to reduce sonar interference. Most alternator charging systems do not account for this bonding wire, and connect the negative posts of the trolling motor batteries to the negative posts of the crank/starting battery. These external connections can damage connected electronics and the electrical system of your trolling motor, voiding your warranty. Review your charger's manual carefully or consult the manufacturer prior to use to ensure your charger is compatible.

Minn Kota recommends using Minn Kota brand chargers to recharge the batteries connected to your Minn Kota trolling motor, as they have been engineered to work with motors that include a bonding wire. Learn more about Minn Kota chargers online at [minnkota.johnsonoutdoors.com](http://minnkota.johnsonoutdoors.com).

# CONNECTING THE BATTERIES IN SERIES

## › Additional Accessories Connected to Trolling Motor Batteries

Significant damage to your Minn Kota motor, your boat electronics, and your boat can occur if incorrect connections are made between your trolling motor batteries and other battery systems. Minn Kota recommends using an exclusive battery system for your trolling motor. Where possible, accessories should be connected to a separate battery system. Radios and sonar units should not be connected to any trolling motor battery systems as interference from the trolling motor is unavoidable. If connecting any additional accessories to any trolling motor battery system, or making connections between the trolling motor batteries and other battery systems on the boat, be sure to carefully observe the information below.

The negative (-) connection must be connected to the negative terminal of the same battery that the trolling motor negative lead connects to. In the diagrams below this battery is labeled “Low Side” Battery. Connecting to any other trolling motor battery will input positive voltage into the “ground” of that accessory, which can cause excess corrosion. Any damage caused by incorrect connections between battery systems will not be covered under warranty.

## › Automatic Jump Start Systems and Selector Switches

Automatic jump start systems and selector switches tie the negatives of the connected batteries together. Connecting these systems to the “High Side” Battery or “Middle” Battery in the diagrams below and will cause significant damage to your trolling motor and electronics. The only trolling motor battery that is safe to connect to one of these systems is the “Low Side” Battery.

# CONNECTING THE BATTERIES IN SERIES (IF REQUIRED FOR YOUR MOTOR)

## › 24-Volt Systems

Two 12-volt batteries are required. The batteries must be wired in series, only as directed in the wiring diagram, to provide 24 volts.

1. Make sure that the motor is switched off (speed selector on “0”).
2. Connect a connector cable to the positive (+) terminal of battery 1 and to the negative (-) terminal of battery 2.
3. Connect positive (+) red motor lead to positive (+) terminal on battery 2.
4. Connect negative (-) black motor lead to negative (-) terminal of battery 1.

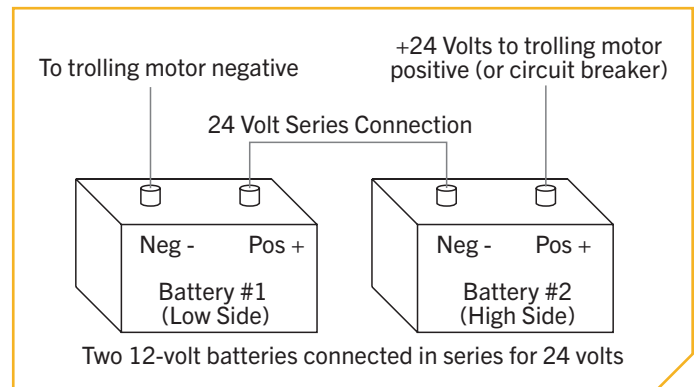

## WARNING

For safety reasons do not switch the motor on until the propeller is in the water. If installing a leadwire plug, observe proper polarity and follow instructions in your boat owner’s manual.

## WARNING

- For safety reasons, disconnect the motor from the battery or batteries when the motor is not in use or while the battery/batteries are being charged.
- Improper wiring of 24/36 volt systems could cause battery explosion.
- Keep leadwire wing nut connections tight and solid to battery terminals.
- Locate battery in a ventilated compartment.

# CONNECTING THE BATTERIES IN SERIES

## 36-Volt Systems

Three 12-volt batteries are required. The batteries must be wired in series, only as directed in the wiring diagram, to provide 36 volts.

1. Make sure that the motor is switched off (speed selector on "0").
2. Connect a connector cable to the positive (+) terminal of battery 1 and to the negative (-) terminal of battery 2 and another connector cable from the positive (+) terminal of battery 2 to the negative (-) terminal of battery 3.
3. Connect positive (+) red motor lead to positive (+) terminal on battery 3.
4. Connect negative (-) black motor lead to negative (-) terminal of battery 1.

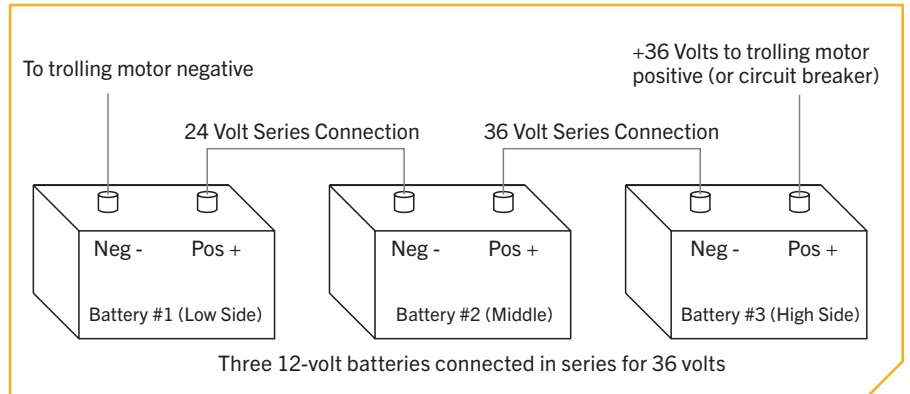

### **WARNING**

For safety reasons, do not switch the motor on until the propeller is in the water. If installing a leadwire plug, observe proper polarity and follow instructions in your boat owner's manual.

### **WARNING**

- For safety reasons, disconnect the motor from the battery or batteries when the motor is not in use or while the battery/batteries are being charged.
- Improper wiring of 24/36 volt systems could cause battery explosion.
- Keep leadwire wing nut connections tight and solid to battery terminals.
- Locate battery in a ventilated compartment.

# COMPLETING THE INSTALLATION



## COMPLETING THE ULTERRA QUEST INSTALLATION

The Ulterra QUEST is an advanced trolling motor. To maximize its performance, mechanical and electrical systems should be set and calibrated to fit every user's installation. This portion of the installation will cover how to verify power, install the Bow-mount Stabilizer, and more. The installation will conclude with connecting Accessory Cables and setting motor preferences for ease of use. Minn Kota recommends connecting the trolling motor to the One-Boat Network app to assist in these steps. Find more information in the One-Boat Network App document included with the trolling motor or the One-Boat Network Owner's Manual found online at [minnkota.johnsonoutdoors.com](http://minnkota.johnsonoutdoors.com).

### COMPLETING THE INSTALLATION >

#### > Verifying Power

Each time the trolling motor is powered "on," the control board will auto-detect the power supplied from the battery system and adjust the thrust output based on a 24V or 36V battery system. To verify power to the trolling motor, connect the Ulterra QUEST to power. At specific points in the installation, power will be disconnected or turned "off" to ensure a safe environment for installation.

- 1
  - a. Locate the Indicator Panel at the front of the Mount. Power on the trolling motor by pressing the Power  button on the Indicator Panel. When the trolling motor is on, the System Status  LED will be blue.
  - b. To turn the motor "off," press and release the Power button. When the Motor is powered off, the System Status  LED will not be illuminated.

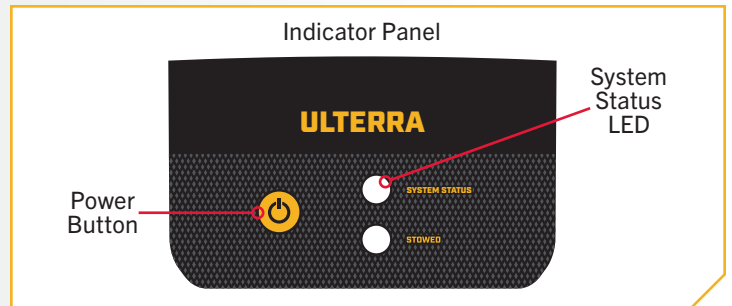

**NOTICE:** In instances where the trolling motor is updating, the System Status LED will flash blue while the update is performed. Once the update is complete, the system will self-reboot and perform the normal start-up sequence. If a standard power-up sequence is not experienced, please see the Troubleshooting section of the Ulterra QUEST Owner's Manual to identify any errors. To learn more about software updates, please see the Owner's Manual for the One-Boat Network or Advanced GPS Navigation Wireless Remote.

#### > Installing the Bow-Mount Stabilizer

Ulterra QUEST motors with a 72" shaft length come with an MKA-60 Bow-Mount Stabilizer Kit (Item #9 and Assembly #E). This accessory stabilizes the shaft and control head when the motor is stowed for transport. Motors with shaft lengths under 72" may purchase the MKA-60 separately as an optional accessory (1862060). For instructions on installing the MKA-60 to the Ulterra QUEST, refer to the document provided with the Bow-Mount Stabilizer Kit.

## › Powering on the Wireless Remote

1







### ITEM(S) NEEDED



#8 x 1



#7 x 1

- Power on the trolling motor.
- To turn on the Wireless Remote (Item #8), press and hold the Power  button on the side of the Remote.
- A message will appear on the display screen. Read the disclaimer, then press the Steer Right  button to select "I Agree."
- The content on the display screen will populate. Remote functions to manually control the motor are now active, including Speed Up , Speed Down , Steer Left , Steer Right , and Prop On/Off.
- When the Advanced GPS Navigation system has obtained a minimum GPS signal strength of one bar, all remaining functions will become available.

**NOTICE:** Attaching the Lanyard (Item #7) to the Wireless Remote is optional.

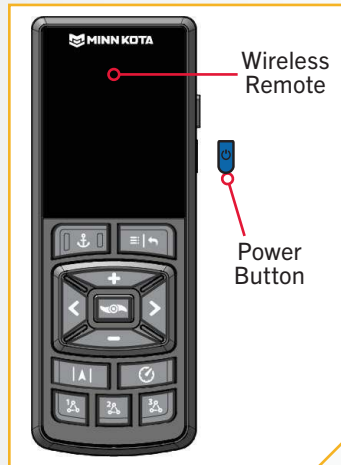

### Warning!

You are responsible for the safe and prudent operation of your boat. This product does not relieve you from the responsibility for safe operation of your boat.

I Agree



**NOTICE:** The Wireless Remote comes from the factory paired to the Ulterra QUEST.

**NOTICE:** A Remote Cradle accessory (1866675) can be purchased for mounting the Wireless Remote or attaching the Remote to a belt clip.

# INSTALLING THE FOOT PEDAL

## Installing the Foot Pedal

1

### ITEM(S) NEEDED

 #14 x 4

 #C x 1

- Take the Foot Pedal (Item #C) and turn it over. Put a Foot Pedal Pad (Item #14) in each of the pad locations.

**NOTICE:** Adding the Foot Pedal pads is optional. The pads are recommended when using the Foot Pedal on non-carpeted surfaces.

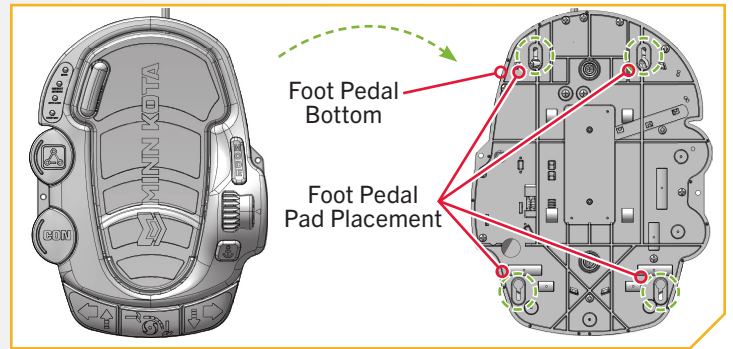

2

- Locate the Foot Pedal Power Cord that exits the Mount of the trolling motor, next to the Power Cables. Unscrew the Cap on the Plug at the end of the Foot Pedal Power Cord.
- Locate the 4-Pin Plug from the Foot Pedal and unscrew the Cap.
- Align the 4-Pin Plug from the Foot Pedal with the Plug from the trolling motor. Firmly push the Plugs together. Secure the connection by rotating the collar on the Foot Pedal Power Cord in a clockwise direction.

**NOTICE:** The connectors are keyed to prevent reversed installation.

**NOTICE:** When the Foot Pedal Power Cord is not in use, ensure that the Cap is on and firmly secured.

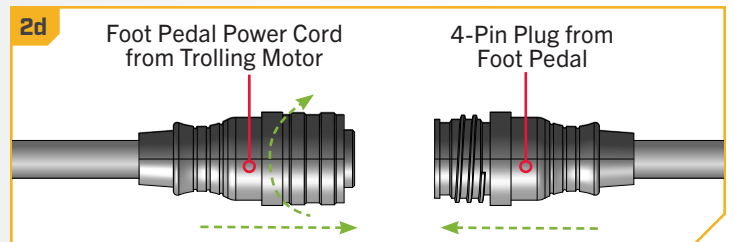
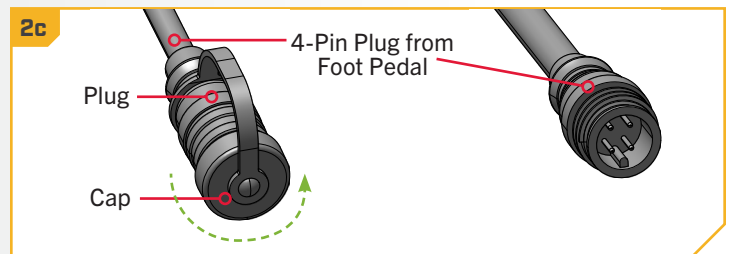
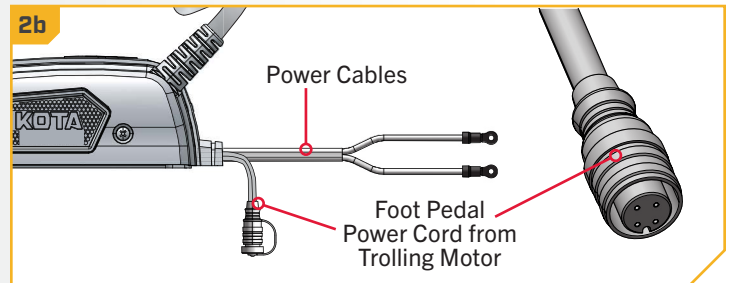



# IDENTIFYING TROLLING MOTOR FEATURES AND THEIR ASSOCIATED CABLES

## IDENTIFYING TROLLING MOTOR FEATURES AND THEIR ASSOCIATED CABLES

### Feature & Cable Identification

The Ulterra QUEST is pre-installed with Advanced GPS Navigation - including the ability to connect via Ethernet to a Humminbird unit. The motor is also pre-installed with sonar, either Dual Spectrum CHIRP or Built-in MEGA Side Imaging. These features may be installed on their own or in combination with another feature. All of these features require Accessory Cables to be connected to an output device. The connectors are present on the trolling motor and have cables that exit below the Control Head. To better identify Accessory Cables present, refer to the diagrams that detail what the Dual Spectrum CHIRP, Built-in MEGA Side Imaging and Advanced GPS Navigation connectors look like.

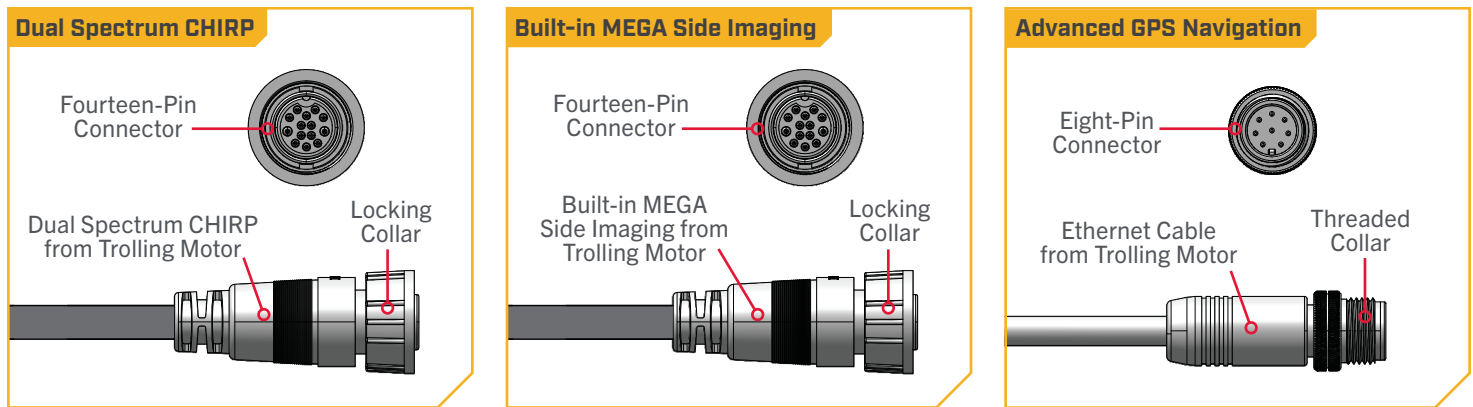

### Identifying Connectors

Two connectors are present below the Control Head. The trolling motor will be equipped with:

**Advanced GPS Navigation & Dual Spectrum CHIRP or Built-in MEGA Side Imaging** - Advanced GPS Navigation is pre-installed on your trolling motor. One Eight-Pin Advanced GPS Ethernet Connector will exit the base of the Control Head and rest just below the Control Head next to the Coil Cord. If the Advanced GPS Navigation on the trolling motor will be used with a fish finder, an Ethernet Cable may be attached to the Advanced GPS Ethernet Connector below the Control Head. See the "Advanced GPS Navigation" section of this document for details on how to install the Advanced GPS Ethernet Connector to a Humminbird.

Dual Spectrum CHIRP or Built-in MEGA Side Imaging is also pre-installed on your trolling motor. One Sonar Accessory Cable will exit the base of the Control Head and run down the center of the Coil Cord. The end of this Cable has a Fourteen-Pin Connector. Motors with Dual Spectrum CHIRP or Built-in MEGA Side Imaging will also have a transducer in the Lower Unit. The appearance of the transducer will vary depending on sonar type.

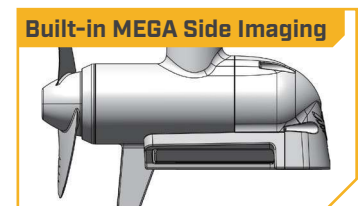
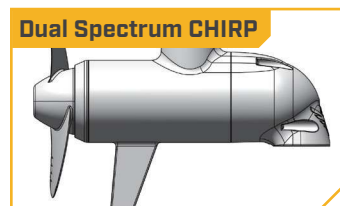
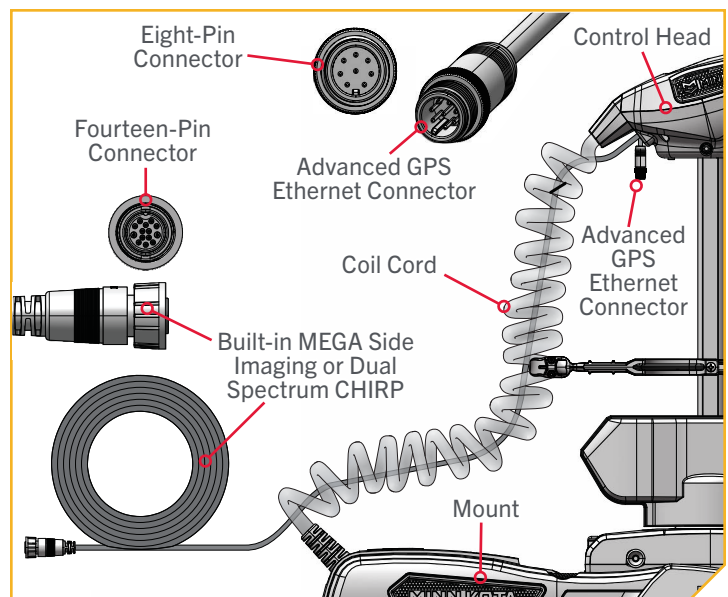

# DUAL SPECTRUM CHIRP

## › Feature & Cable Management

### DUAL SPECTRUM CHIRP ›

Your trolling motor may be pre-installed with a transducer system featuring Humminbird's Dual Spectrum CHIRP. CHIRP stands for "Compressed High Intensity Radar Pulse." Dual Spectrum CHIRP is a 2D sonar transducer with a temperature sensor that is integrated into the lower unit of the trolling motor. Humminbird also utilizes a proprietary, best-in-class transducer designed and built to maximize fish detail, as well as coverage area. Dual Spectrum CHIRP scans the water for fish similar to the way the seek function on your truck's radio scans the airwaves for FM stations. By covering a wide range of frequencies, CHIRP produces more accurate, more detailed returns of fish, structure, and the bottom.

Humminbird's Dual Spectrum CHIRP gives you full spectrum capability, plus the power to select your own start and end frequencies by operating in two different modes. Wide Mode for maximum coverage and Narrow Mode for maximum detail. Wide mode allows you to search deep and wide. Is it used for watching your lure while vertical jigging, or gaining a more expansive view in shallow water. Narrow Mode is used to hone in on the small stuff that makes a big difference. Narrow Mode provides a precise perspective of the water below, helping you target individual fish, or identify fish hidden in structure and/or tight to the bottom.

Dual Spectrum CHIRP features:

**SUPERIOR TARGET SEPARATION** - Separating fish from their habitat is the name of the game. And now, you'll be able to tell the difference more easily between bait and game fish, and nearby structure and vegetation.

**CLEARLY DEFINED FISH ARCHES** - We've got bad news for your arch nemesis. Large game fish will show up on your screen as long, well-defined arches, for quick identification and accurate lure presentation.

**STRONG RETURNS WITHOUT NOISE** - Stop seeing things that aren't there. A high signal-to-noise ratio translates to better defined targets, less clutter and greater certainty that what you're looking at on-screen is legit.

Dual Spectrum CHIRP Lower Unit

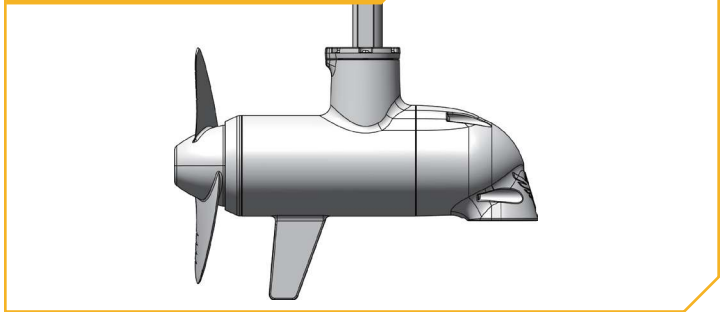

Wide Mode

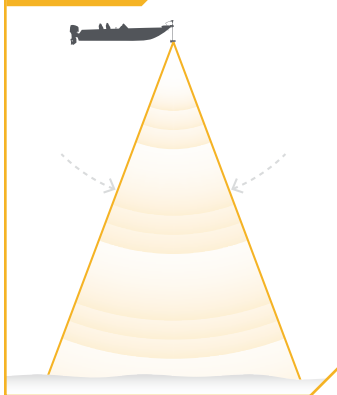

Narrow Mode

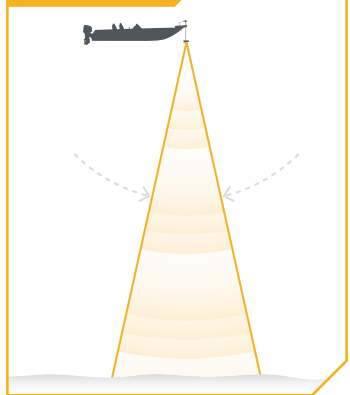

Target Separation

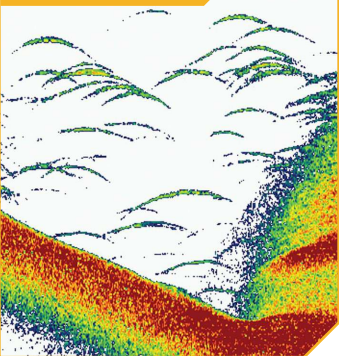

Defined Fish Arches

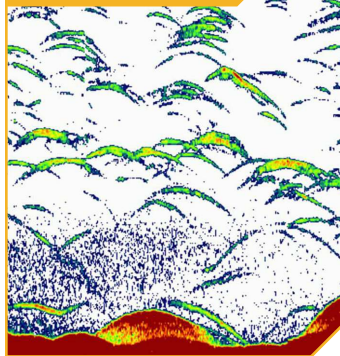

Strong Returns

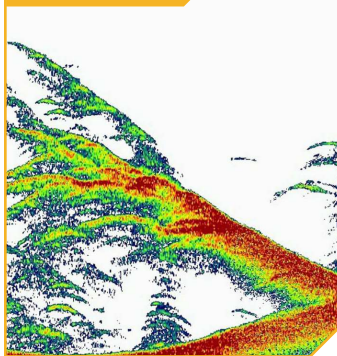

The integrated design of the Dual Spectrum CHIRP transducer protects it in the lower unit of the trolling motor from underwater hazards and prevents tangles and damage to the transducer cables. In certain situations, air bubbles may adhere to the surface of the Dual Spectrum CHIRP transducer and affect the performance. If this happens, simply wipe the surface of the transducer with your finger.

## › Considerations for Connecting and Routing Dual Spectrum CHIRP

If Dual Spectrum CHIRP is pre-installed on your trolling motor, one Dual Spectrum CHIRP accessory cable will exit the base of the Control Head and run down the center of the Coil Cord. Dual Spectrum CHIRP requires cables to be connected to an output device such as a Humminbird® fish finder. The Dual Spectrum CHIRP cable that exits the Control Head is "Apex and Solix Ready." Connecting the trolling motor equipped with a Dual Spectrum CHIRP transducer to a compatible fish finder gives you a 2D sonar view of what is happening directly below your trolling motor. To determine if your fish finder is compatible with Dual Spectrum CHIRP, please visit [minnkota.johnsonoutdoors.com](http://minnkota.johnsonoutdoors.com) to check compatibility. The Dual Spectrum CHIRP cable from the trolling motor may be plugged directly into a Solix or Apex, directly into an Extension Cable or directly into a Humminbird® Helix Adapter Cable.

**EXTENSION CABLES** - The Dual Spectrum CHIRP cable from the trolling motor may not be long enough to reach your fish finder. If the cable length does not reach the desired fish finder installation location, extension cables are available. A 10-foot extension cable (EC M3 14W10 - 10' transducer extension cable - 720106-1) and a 30-foot extension cable (EC M3 14W30 - 30' transducer extension cable - 720106-2) are available from [humminbird.johnsonoutdoors.com](http://humminbird.johnsonoutdoors.com). Both the 10-foot and 30-foot extension cables also come "Apex and Solix Ready." The Extension Cables may plug directly into a Solix or Apex or directly into a Helix Adapter Cable.

**HUMMINBIRD HELIX ADAPTER CABLES** - If connecting to a Humminbird® Helix fish finder, an adapter cable accessory is included that will allow the connection of any compatible Humminbird® Helix fish finder. The Helix adapter cables will plug directly into the Helix fish finder.

**OTHER FISH FINDER ADAPTER CABLES** - If connecting to other fish finders on the market, check for compatibility or any required adapter cables online at [minnkota.johnsonoutdoors.com](http://minnkota.johnsonoutdoors.com).

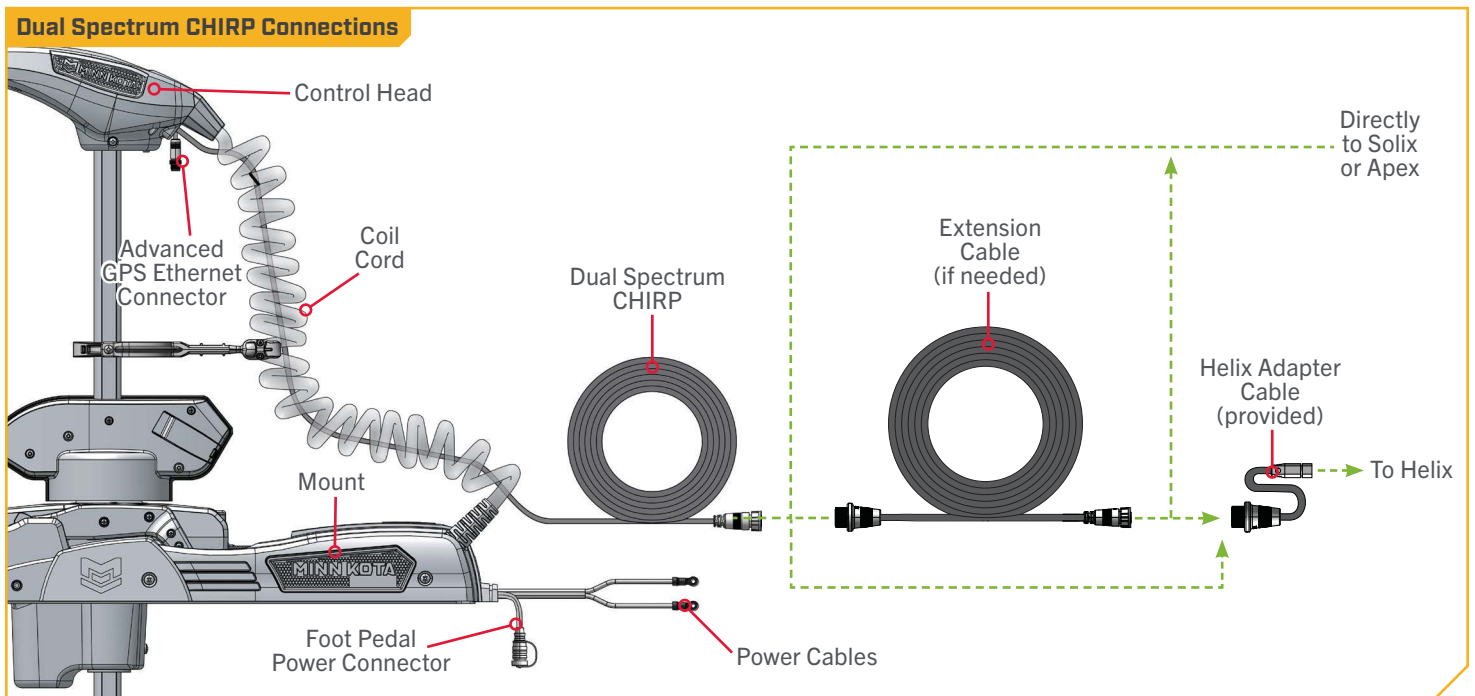

# DUAL SPECTRUM CHIRP

All Dual Spectrum CHIRP Ulterra QUEST motors are equipped with an internal bonding wire. Incorrect rigging will cause sonar interference and can damage your trolling motor, electronics, and other boat accessories. To minimize trolling motor interference, ensure that the fish finder and trolling motor are powered by separate batteries. Refer to the "Battery & Wiring Installation" section of this manual for correct rigging instructions.

The Dual Spectrum CHIRP cables are shielded to minimize interference. To protect this shielding, the cables should not be pulled tight against sharp angles or hard objects. If using cable ties, do not over-tighten. Any excess cable should be bundled in a loose loop of no less than 4" in diameter. The connection cable should be routed to the fish finder following Minn Kota recommendations on routing the cables to optimize mobility and maximize functionality. Follow the instructions below for completing all connections and then follow the instructions for "Securing Accessory Cables" to complete the output cable installation.

## CAUTION

Failure to follow the recommended wire routing for installed features, if equipped, may cause damage to the product and void your product warranty. Route cables away from pinch points or other areas that may cause them to bend in sharp angles. Routing the cables in any way other than directed may cause damage to the cables by being pinched or severed. Do not over-tighten the cable ties as it may damage the wires.

1

**NOTICE:** Your fish finder should be turned off until this procedure is complete.

- a. Place the motor in the deployed position.

**NOTICE:** For instructions on deploying the Ulterra QUEST, see the "Quick Stow & Deploy" section of this manual.

- b. Locate the Fourteen-Pin Connector at the end of the Dual Spectrum CHIRP accessory cable. The cable will exit the base of the Control Head and run down the center of the Coil Cord.
- c. Determine if the Plug on the end of the Dual Spectrum CHIRP accessory cable will be attached directly to:
  - 1) a Humminbird® Solix or Apex fish finder,
  - 2) a Dual Spectrum CHIRP Extension Cable,
  - 3) a Helix Adapter Cable or a compatible fish finder adapter cable.

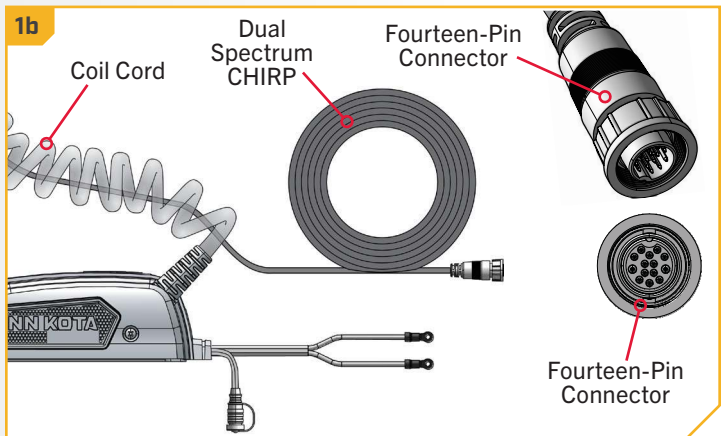

## 2

- d. If installing directly to a Solix or Apex, the connection will be flat on the back of the fish finder display.
- e. Align the pins on the Accessory Cable with the receptacle on the fish finder. Notice the keyed connectors. Tighten the Collar from the accessory cable to secure the connection. Once directly installed to the Solix or Apex, the connection is complete.

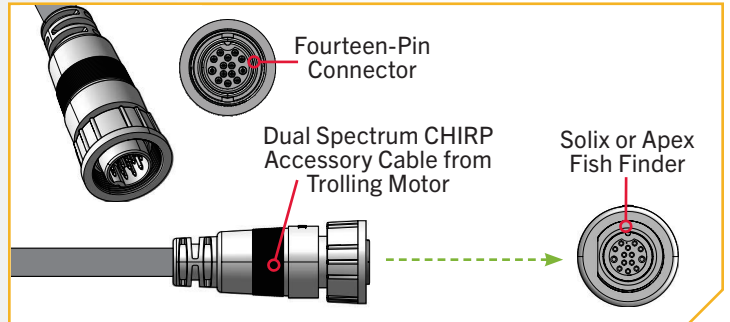

## 3

- f. If installing directly to a Dual Spectrum CHIRP Extension Cable, align the pins on the accessory cable with the receptacle on the extension cable. Notice the keyed connectors. Tighten the Collar from the accessory cable to secure the connection.
- g. If the Dual Spectrum CHIRP extension cable will be attached directly to a Humminbird® Solix or Apex, the connection will look exactly like the installation directly into a Humminbird Solix or Apex fish finder.

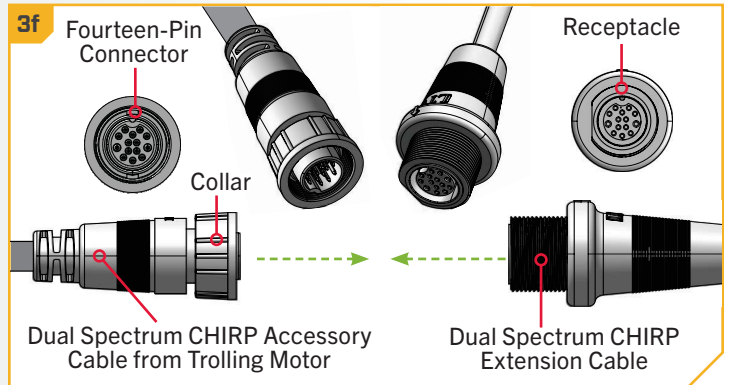

**NOTICE:** A 10-foot extension cable (EC M3 14W10 - 10' transducer extension cable - 720106-1) and a 30-foot extension cable (EC M3 14W30 - 30' transducer extension cable - 720106-2) are available from [humminbird.johnsonoutdoors.com](http://humminbird.johnsonoutdoors.com).

# BUILT-IN MEGA SIDE IMAGING

## 4

### ITEM(S) NEEDED



- h. If installing directly to a Helix Adapter Cable, align the pins on the accessory cable or extension cable with the receptacle on the Helix Adapter Cable (Item #18). Notice the keyed connectors. Tighten the Collar from the accessory cable or extension cable to secure the connection.
- i. If the Helix Adapter Cable will be attached directly to a Humminbird® Helix, plug it in the Helix Adapter Cable Keyed Connection on the back of the fish finder.

**NOTICE:** If connecting to other fish finders on the market, check for compatibility or any required adapter cables online at [minnkota.johnsonoutdoors.com](http://minnkota.johnsonoutdoors.com).

- j. If the trolling motor has more than one external connector for an output device, complete the connection for that specific output and then follow the instructions for "Securing Accessory Cables" to complete the output cable installation.

**NOTICE:** If unsure of what features the trolling motor may be installed with that require connection to an output device, review the "Identifying Trolling Motor Features and Their Associated Cables" section in this document.

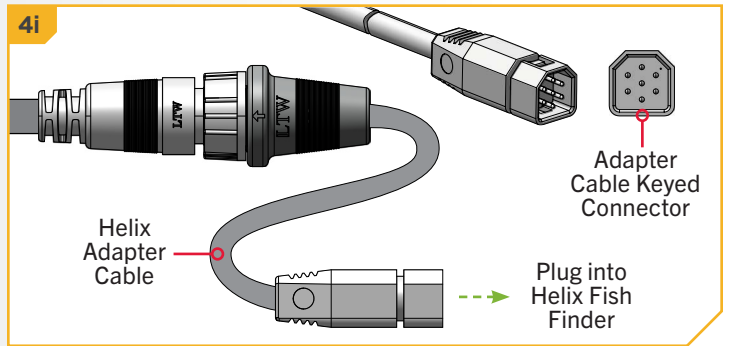
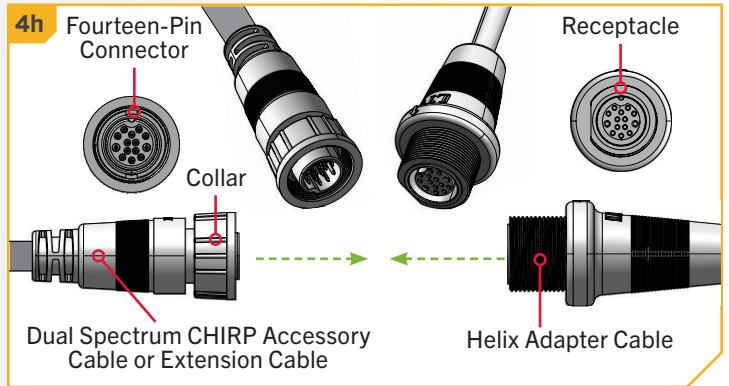

## BUILT-IN MEGA SIDE IMAGING >

MEGA Imaging technology took fish finding into the megahertz frequency for the very first time. Now Built-in MEGA Side Imaging+ delivers up to 3X the output of standard Side Imaging®. Humminbird improved this technology even further by extending the depth range and expanding the side coverage areas, all while improving the crystal clear imagery. Built-in MEGA Side Imaging+ comes available in the Minn Kota flagship families of trolling motors, including Ultrex and Ulterra, with 200 feet of coverage on either side of your boat. With Humminbird MEGA imaging sonar built right into the trolling motor, you now have a crystal clear view of what's directly to the left and right of your boat, without having to manage all of the cables that come with external transducers. The Built-in MEGA SI transducer is only available on new models equipped from the factory and cannot be added to an existing trolling motor.

## › Considerations for Connecting and Routing Built-in MEGA Side Imaging

If Built-in MEGA Side Imaging is pre-installed on your trolling motor, one Built-in MEGA Side Imaging accessory cable will exit the base of the Control Head and run down the center of the Coil Cord. Built-in MEGA Side Imaging requires cables to be connected to an output device such as a Humminbird® fish finder. The Built-in MEGA Side Imaging cable that exits the Control Head is "Apex and Solix Ready." Connecting the trolling motor equipped with a Built-in MEGA Side Imaging transducer to a compatible fish finder gives you a 2D sonar view of what is happening directly below your trolling motor. To determine if your fish finder is compatible with Built-in MEGA Side Imaging, please visit [minnkota.johnsonoutdoors.com](http://minnkota.johnsonoutdoors.com) to check compatibility. The Built-in MEGA Side Imaging cable from the trolling motor may be plugged directly into a Solix or Apex, directly into an Extension Cable or directly into a Humminbird® Helix Adapter Cable.

**EXTENSION CABLES** - The Built-in MEGA Side Imaging cable from the trolling motor may not be long enough to reach your fish finder. If the cable length does not reach the desired fish finder installation location, extension cables are available. A 10-foot extension cable ([EC M3 14W10 - 10' transducer extension cable - 720106-1](#)) and a 30-foot extension cable ([EC M3 14W30 - 30' transducer extension cable - 720106-2](#)) are available from [humminbird.johnsonoutdoors.com](http://humminbird.johnsonoutdoors.com). Both the 10-foot and 30-foot extension cables also come "Apex and Solix Ready." The Extension Cables may plug directly into a Solix or Apex or directly into a Helix Adapter Cable.

**HUMMINBIRD HELIX ADAPTER CABLES** - If connecting to a Humminbird® Helix fish finder, an adapter cable accessory is included that will allow the connection of any compatible Humminbird® Helix fish finder. The Helix adapter cable will plug directly into the Helix fish finder.

**OTHER FISH FINDER ADAPTER CABLES** - If connecting to other fish finders on the market, check for compatibility or any required adapter cables online at [minnkota.johnsonoutdoors.com](http://minnkota.johnsonoutdoors.com).

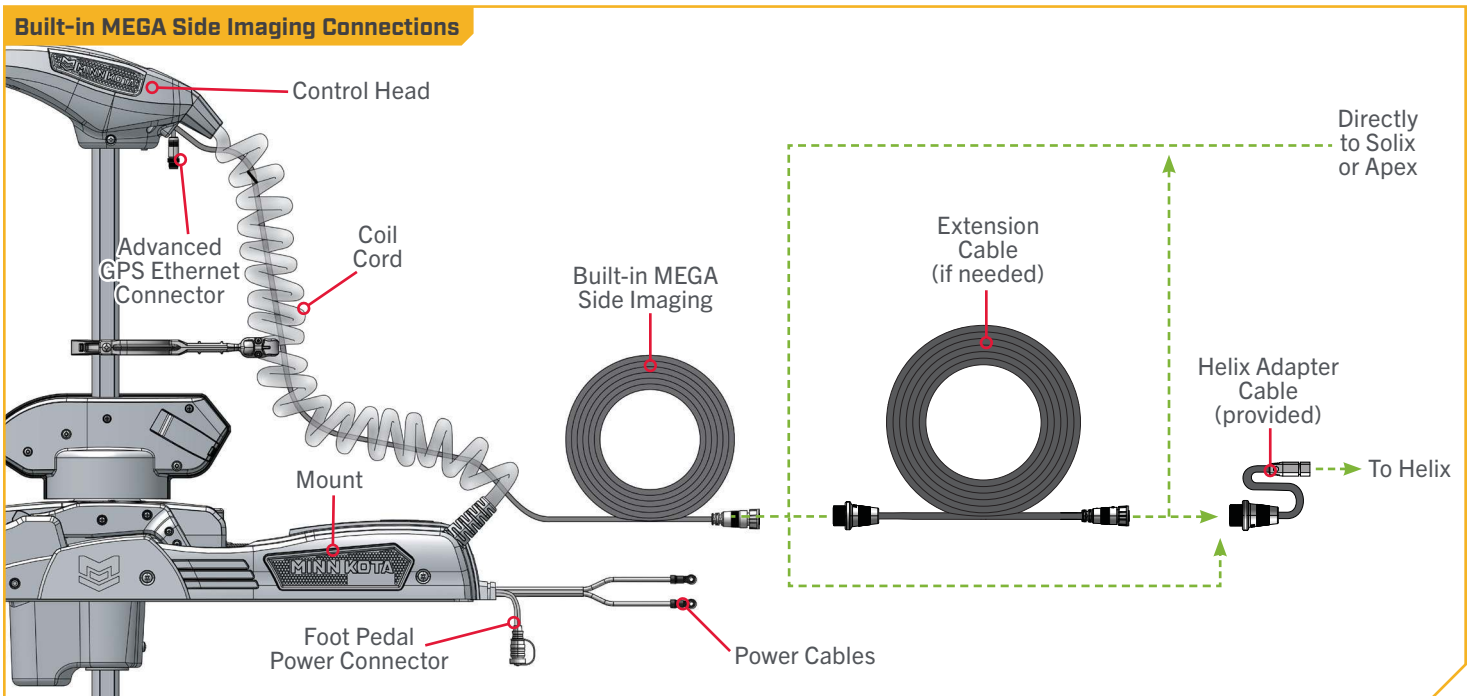

# BUILT-IN MEGA SIDE IMAGING

## CAUTION

Failure to follow the recommended wire routing for installed features, if equipped, may cause damage to the product and void your product warranty. Route cables away from pinch points or other areas that may cause them to bend in sharp angles. Routing the cables in any way other than directed may cause damage to the cables by being pinched or severed. Do not over-tighten the cable ties as it may damage the wires.

**NOTICE:** You can only view Side Imaging with a MEGA DI or MEGA SI HELIX G2N, G3N or G4N Series model and a required adapter, or with any SOLIX or APEX Series model. The built-in transducer cannot supply MEGA Imaging to Humminbird models that do not already have the capability. If you have a G2/G2N, G3/G3N, G4/G4N HELIX that is not a MEGA SI or MEGA DI model, you will still get 2D Dual Spectrum CHIRP Sonar from the transducer. SOLIX G1 and HELIX G2 and G2N units need to be running the latest software update to view sonar from motors with Built-in MEGA Imaging. You can get the latest version of software for your fish finder on [humminbird.johnsonoutdoors.com](http://humminbird.johnsonoutdoors.com). Built-in MEGA Imaging is not supported by HELIX G1 models or other brands of fish finders.

1

**NOTICE:** Your fish finder should be turned off until this procedure is complete.

- a. Place the motor in the deployed position.

**NOTICE:** For instructions on deploying the Ulterra QUEST, see the “Quick Stow & Deploy” section of this manual.

- b. Locate the Fourteen-Pin Connector at the end of the Built-in MEGA Side Imaging accessory cable. The cable will exit the base of the Control Head and run down the center of the Coil Cord.
- c. Determine if the Plug on the end of the Built-in MEGA Side Imaging accessory cable will be attached directly to:
  - 1) a Humminbird® Solix or Apex fish finder,
  - 2) a Built-in MEGA Side Imaging Extension Cable,
  - 3) a Helix Adapter Cable or a compatible fish finder adapter cable.

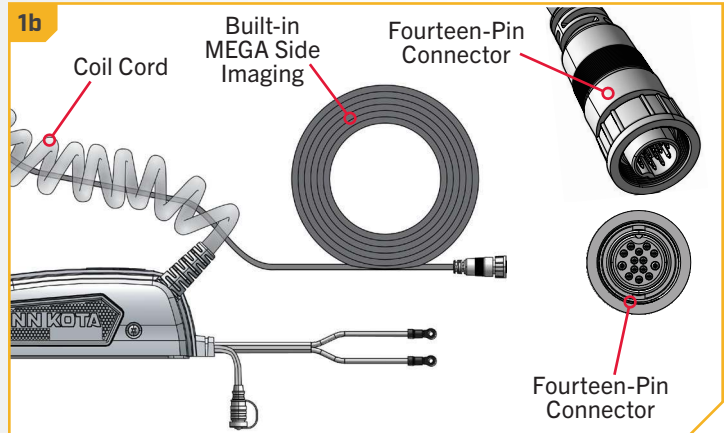



## BUILT-IN MEGA SIDE IMAGING

2

- d. If installing directly to a Solix or Apex, the connection will be flat on the back of the fish finder display.
- e. Align the pins on the Accessory Cable with the receptacle on the fish finder. Notice the keyed connections. Tighten the Collar from the accessory cable to secure the connection. Once directly installed to the Solix or Apex, the connection is complete.

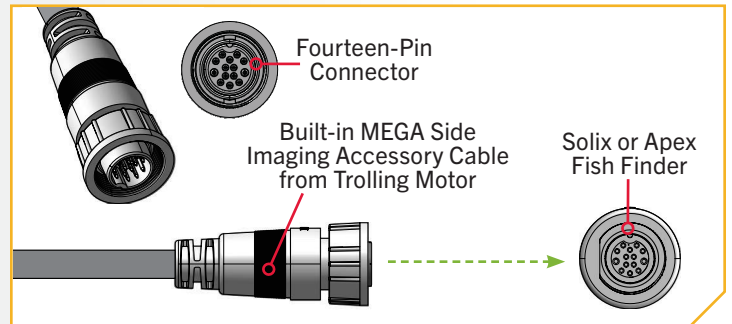

3

- f. If installing directly to a Built-in MEGA Side Imaging Extension Cable, align the pins on the accessory cable with the receptacle on the extension cable. Notice the keyed connectors. Tighten the Collar from the accessory cable to secure the connection.
- g. If the Built-in MEGA Side Imaging Extension Cable will be attached directly to a Humminbird® Solix or Apex, the connection will look exactly like the installation directly into a Humminbird Solix or Apex fish finder.

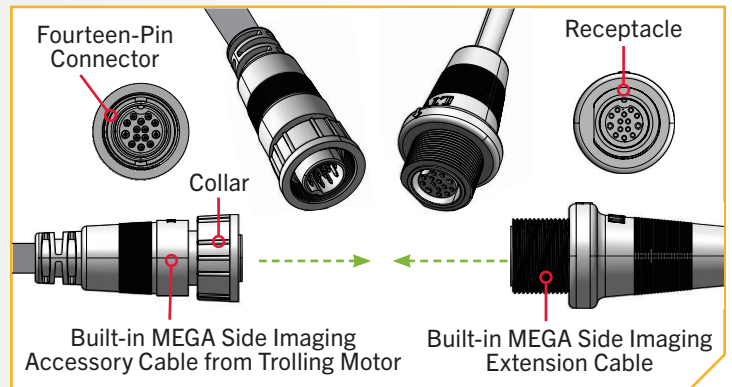

**NOTICE:** A 10-foot extension cable (EC M3 14W10 - 10' transducer extension cable - 720106-1) and a 30-foot extension cable (EC M3 14W30 - 30' transducer extension cable - 720106-2) are available from [humminbird.johnsonoutdoors.com](http://humminbird.johnsonoutdoors.com).

# BUILT-IN MEGA SIDE IMAGING

## 4

### ITEM(S) NEEDED

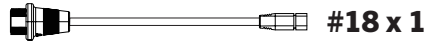

- h. If installing directly to a Helix Adapter Cable, align the pins on the accessory cable or extension cable with the receptacle on the Helix Adapter Cable (Item #18). Notice the keyed connectors. Tighten the Collar from the accessory cable or extension cable to secure the connection.
- i. If the Helix Adapter Cable will be attached directly to a Humminbird® Helix, plug it in the Helix Adapter Cable Keyed Connection on the back of the fish finder.

**NOTICE:** If connecting to other fish finders on the market, check for compatibility or any required adapter cables online at [minnkota.johnsonoutdoors.com](http://minnkota.johnsonoutdoors.com).

- j. If the trolling motor has more than one external connector for an output device, complete the connection for that specific output and then follow the instructions for "Securing Accessory Cables" to complete the output cable installation.

**NOTICE:** If unsure of what features the trolling motor may be installed with that require connection to an output device, review the "Identifying Trolling Motor Features and Their Associated Cables" section in this document.

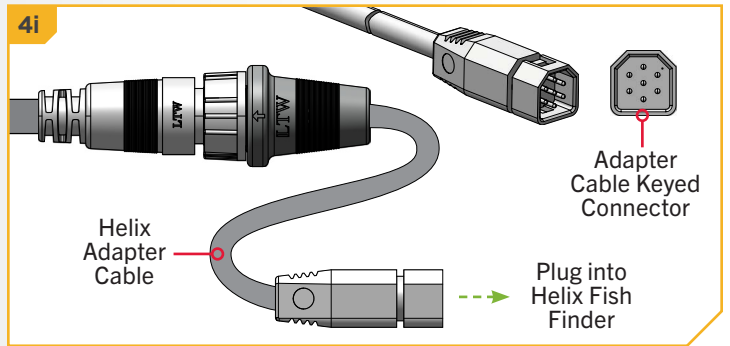
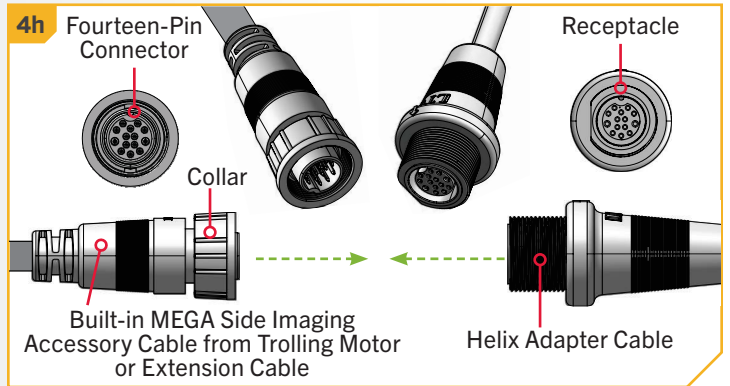

## ADVANCED GPS NAVIGATION >

Your Minn Kota trolling motor and Humminbird fish finder communicate with each other to change the way you fish. Advanced GPS Navigation offers a large array of features including controlling speed, steering, Spot-Lock, and the ability to record and retrace paths on the water, all at your fingertips. To learn more about the GPS capabilities available with your new motor, please refer to the Advanced GPS Navigation Owner's Manual by visiting [minnkota.johnsonoutdoors.com](http://minnkota.johnsonoutdoors.com).

The Wireless Remote and GPS controller make up the Advanced GPS Navigation system. A Wireless Remote comes paired to the controller from the factory. The GPS controller contains a very sensitive compass and is where all GPS satellite and remote signals are received. The GPS controller is located in the trolling motor Control Head and may be connected to a fish finder from a connection cable that exits the Control Head. If the Advanced GPS Navigation system will be used with a fish finder, the Ethernet link between the trolling motor and the fish finder should be connected.

## > Considerations for Connecting and Routing Advanced GPS Navigation

Advanced GPS Navigation is pre-installed on your trolling motor. One eight-pin Advanced GPS Ethernet Connector will exit the base of the Control Head and rest just below the Control Head next to the Coil Cord. If the Advanced GPS Navigation on the trolling motor will be used with a fish finder, an Ethernet Cable will need to be attached to the Advanced GPS Ethernet Connector below the Control Head. Consider the distance between the trolling motor and the fish finder to determine how to complete the Ethernet connection.

**ETHERNET CABLES** - Minn Kota provides one 30 ft Ethernet cable with every trolling motor equipped with Advanced GPS Navigation. The 30 ft Ethernet cable will accommodate a standard Ethernet connection for most installations to a Humminbird fish finder and is "Apex and Solix Ready."

**HUMMINBIRD HELIX ADAPTER CABLES** - Minn Kota provides one Helix Adapter Cable (**AS EC QDE - Ethernet Adapter Cable - 720074-1**) with every trolling motor equipped with Advanced GPS Navigation. If the Ethernet connection is being made between the trolling motor and any Humminbird® Helix fish finder, the Helix Adapter Cable should be used. The Helix Adapter Cable directly connects the Ethernet Cable to a Helix fish finder.

**ETHERNET EXTENSION CABLES** - If the 30 ft Ethernet cable provided with your trolling motor with Advanced GPS Navigation is not long enough to reach the fish finder, an Ethernet Extension cable should be used. The Ethernet Extension cable is available from [humminbird.johnsonoutdoors.com](http://humminbird.johnsonoutdoors.com) and is available in a 30 ft length (**AS ECX 30E - 30' Ethernet Extension Cable - 760025-1**). The Ethernet Extension Cable will plug directly into any length of Ethernet cable.

**NOTICE:** Minn Kota recommends routing the Ethernet Cable or Ethernet Extension Cable through the Coil Cord when making the Ethernet connection. The cables will be installed from the Mount to the Control Head through the Coil Cord and parallel to the Dual Spectrum CHIRP or Built-in MEGA Side Imaging Cable. Bypassing the Coil Cord when routing the Ethernet Cable or Ethernet Extension Cable is not recommended.

## CAUTION

Failure to follow the recommended wire routing for installed features, if equipped, may cause damage to the product and void your product warranty. Route cables away from pinch points or other areas that may cause them to bend in sharp angles. Routing the cables in any way other than directed may cause damage to the cables by being pinched or severed. Do not over-tighten cable ties as it may damage the wires.

# ADVANCED GPS NAVIGATION

## GPS Ethernet Connection

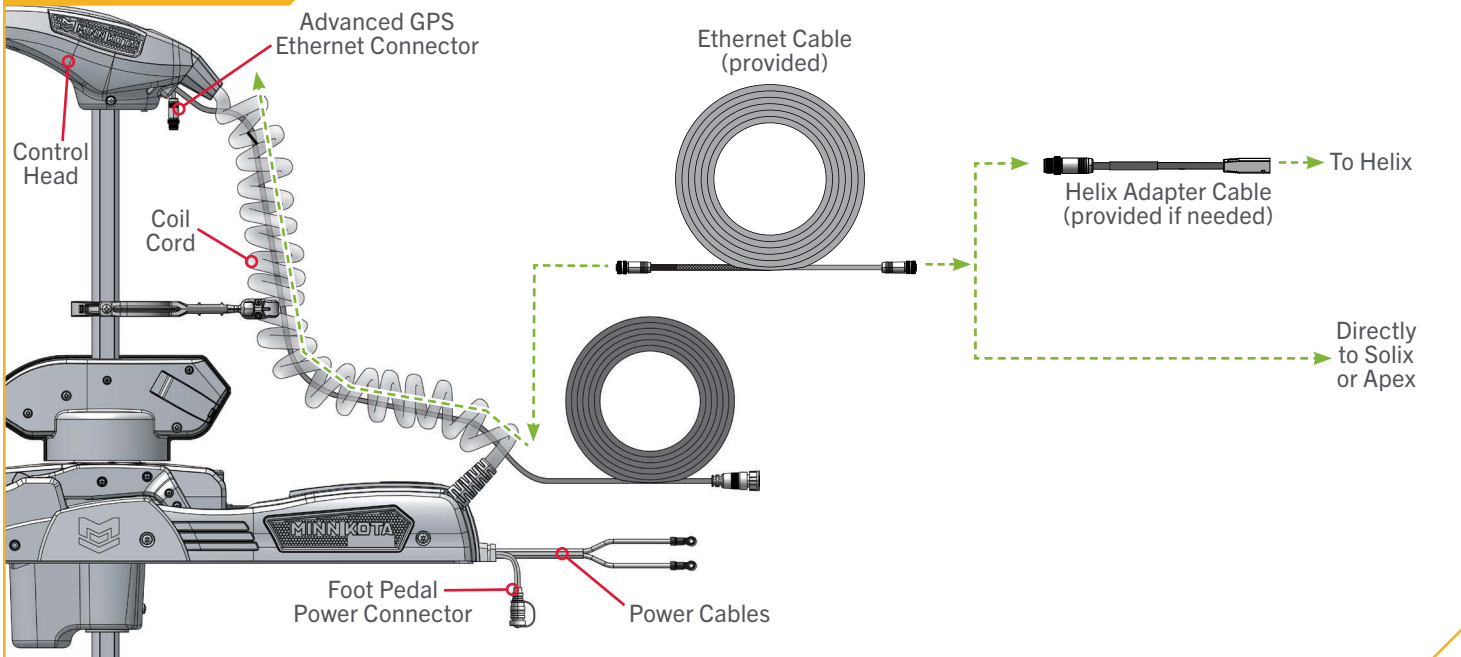

1

**NOTICE:** Your fish finder should be turned off until this procedure is complete.

**NOTICE:** For instructions on deploying the Ulterra QUEST, see the “Quick Stow & Deploy” section of this manual.

- a. Place the motor in the deployed position.
- b. Locate the Eight-Pin Advanced GPS Ethernet Connector below the Control Head. The Advanced GPS Ethernet Connector will exit the base of the Control Head and will rest just below the Control Head next to the Coil Cord.

**NOTICE:** Ulterra QUEST trolling motors with Advanced GPS Navigation are also equipped with Sonar. Sonar is pre-installed from the factory and may be either Dual Spectrum CHIRP or Built-in MEGA Side Imaging. A Sonar Cable will run down the center of the Coil Cord. Review the “Identifying Trolling Motor Features and Their Associated Cables” of this document to identify and learn more about Sonar.

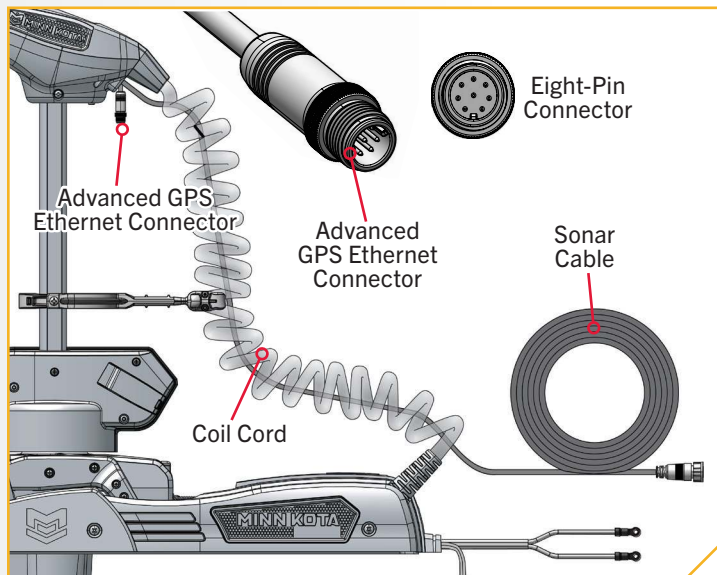

2

ITEM(S) NEEDED

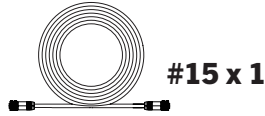

- c. Identify the keyed Receptacle on the Ethernet Cable (Item #15). It will be keyed to fit with the Eight-Pin Advanced GPS Ethernet Connector below the Control Head.

**NOTICE:** The Ethernet Cable has a Receptacle on both ends. The Receptacle on the end of the Ethernet Cable with braided sleeving should be connected to the Advanced GPS Ethernet Connector, while the Receptacle on the bare end without sleeving should be connected to the fish finder.

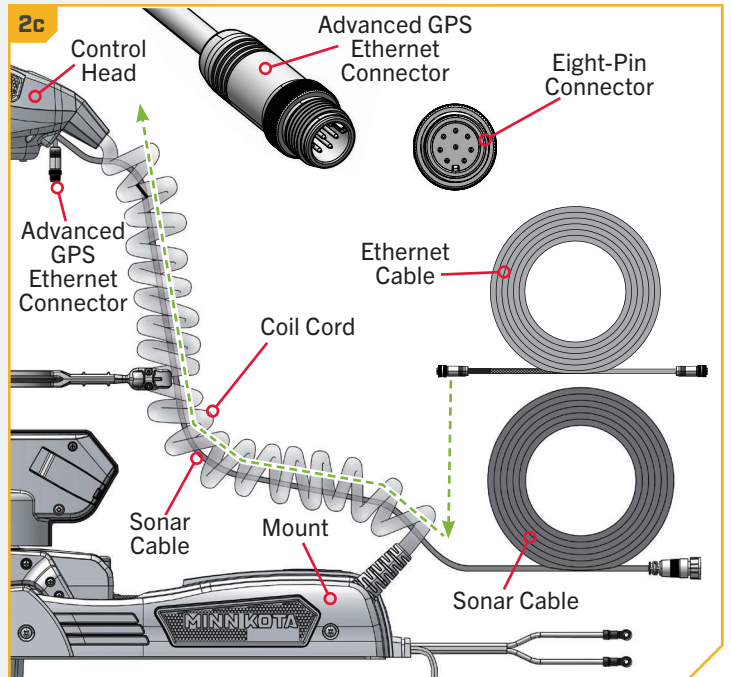
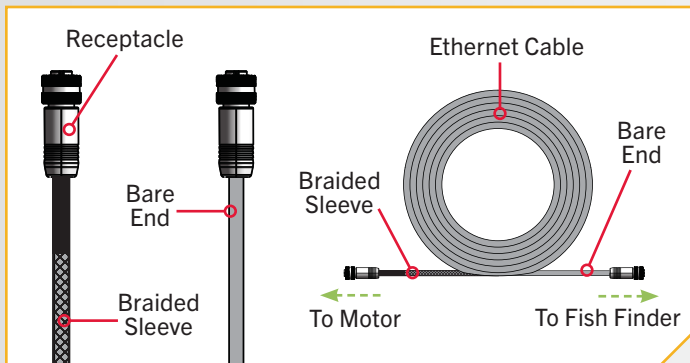

# ADVANCED GPS NAVIGATION

3

- d. Take the Receptacle on the end of the Ethernet Cable covered in a braided sleeve. The Receptacle with the braided sleeve will be inserted into the Coil Cord and connected to the Advanced GPS Ethernet Connector, while the Receptacle on the bare end of the Ethernet Cable will exit the Coil Cord and be connected to the Fish Finder.
- e. Run the Receptacle on the Ethernet Cable up through the bottom of the Coil Cord so it is parallel to the Sonar Cable. Allow enough slack in the cable to attach the Receptacle to the Advanced GPS Ethernet Connector.

**NOTICE:** Ensure that the correct Receptacle on the Ethernet Cable is routed through the Coil Cord and connected to the Advanced GPS Ethernet Connector. The section of the Ethernet Cable covered in a braided sleeve must be routed through the Coil Cord and connected. Do not connect the Receptacle on the bare end to the motor. Failure to connect the correct Receptacle may result in damage to cables.

**NOTICE:** Once all accessory cables are connected, the final installation will require the Ethernet Cable to be secured. See the “Securing Accessory Cables” section of this document for details once all connections are complete.

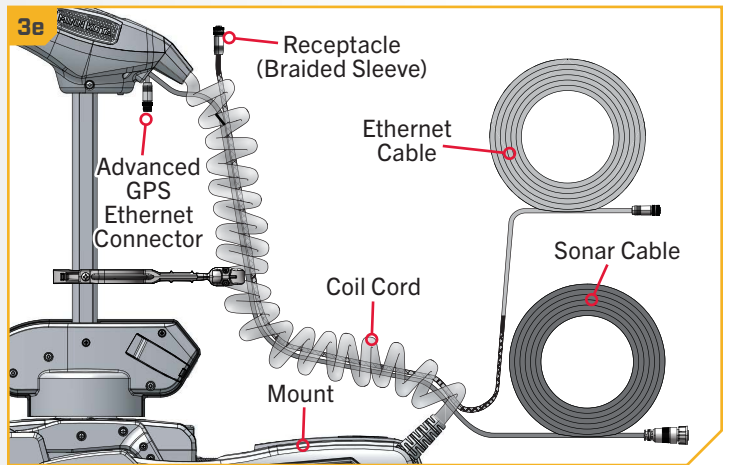
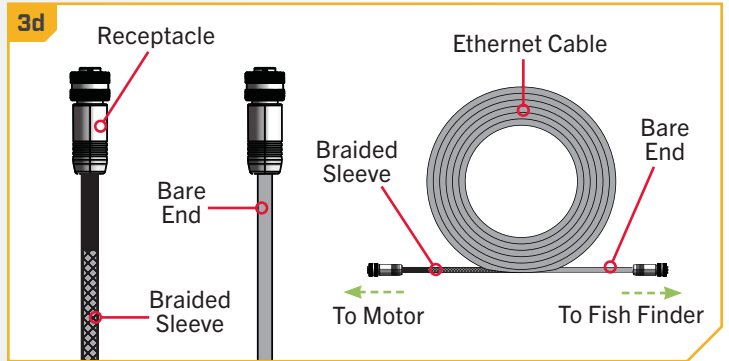

4

- f. To install the Ethernet Cable, align the pins on the Advanced GPS Ethernet Connector with the Receptacle on the Ethernet Cable. Notice the keyed connectors. Tighten the Collar from the Ethernet Cable to secure the connection.
- g. The Ethernet Cable will plug directly into a Solix or Helix Fish Finder or directly into a Helix Adapter Cable.

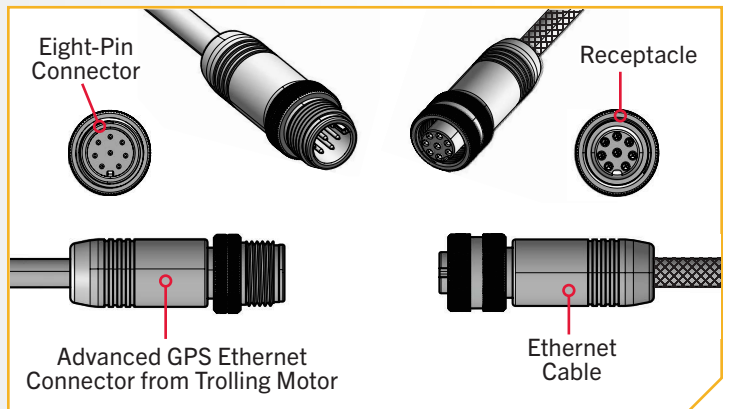

## 5

- h. If installing directly to a Solix or Apex, the connector will be flat on the back of the fish finder display.
- i. Align the Receptacle on the Ethernet Cable with the Eight-Pin Connector on the Apex or Solix fish finder. Notice the keyed connectors. Tighten the Collar from the Ethernet Cable to secure the connection. Once directly installed to the Solix or Apex, the connection is complete.

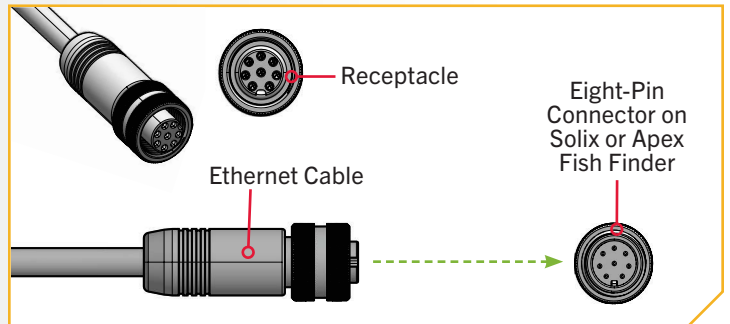

## 6

### ITEM(S) NEEDED



- j. If installing directly to a Helix Adapter Cable (Item #16), align the Receptacle on the Ethernet Cable with the Eight-Pin Connector on the Helix Adapter Cable provided. Notice the keyed connectors. Tighten the Collar from the Ethernet Cable to secure the connection.

**NOTICE:** Minn Kota provides one Helix Adapter Cable (AS EC QDE - Ethernet Adapter Cable - 720074-1) with every trolling motor equipped with Advanced GPS Navigation.

- k. The Helix Adapter Cable directly connects the Ethernet Cable to a Helix fish finder. Locate the Helix Adapter Cable Keyed Connector on the back of the fish finder. Plug the Helix Adapter Cable into the back of the Helix fish finder to complete the connection.
- l. If the trolling motor has more than one feature that requires connection to an output device, complete the connection for that specific output and then follow the instructions for "Securing Accessory Cables" to complete the Accessory Cable installation.

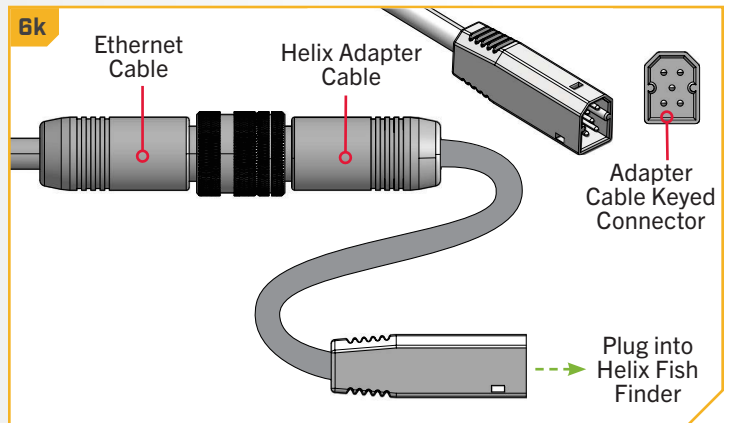
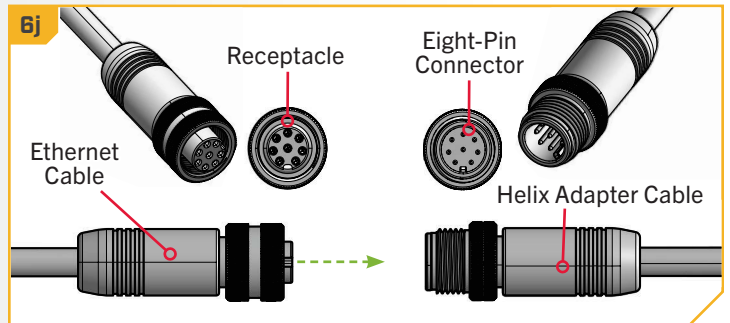

**NOTICE:** If unsure of what features the trolling motor may be installed with that require connection to an output device, please review the "Identifying Trolling Motor Features and Their Associated Cables" section of this manual.

# SECURING ACCESSORY CABLES

## Securing Accessory Cables

Before securing accessory cables, please review the "Identifying Trolling Motor Features and Their Associated Cables" section of this document. When identifying features, it is very important to secure the cables if **two** connections are present below the Control Head. If only **one** cable is present below the Control Head, securing the Accessory Cables is not necessary. All Accessory Cables that will be used on the trolling motor must be routed and all connections secured before completing the installation in this section. To review how feature cables should be routed and connected, review the "Advanced GPS Navigation" and "Dual Spectrum CHIRP" or "Built-in MEGA Side Imaging" sections of this document.

**NOTICE:** If only one cable is present below the Control Head, this installation is not applicable.

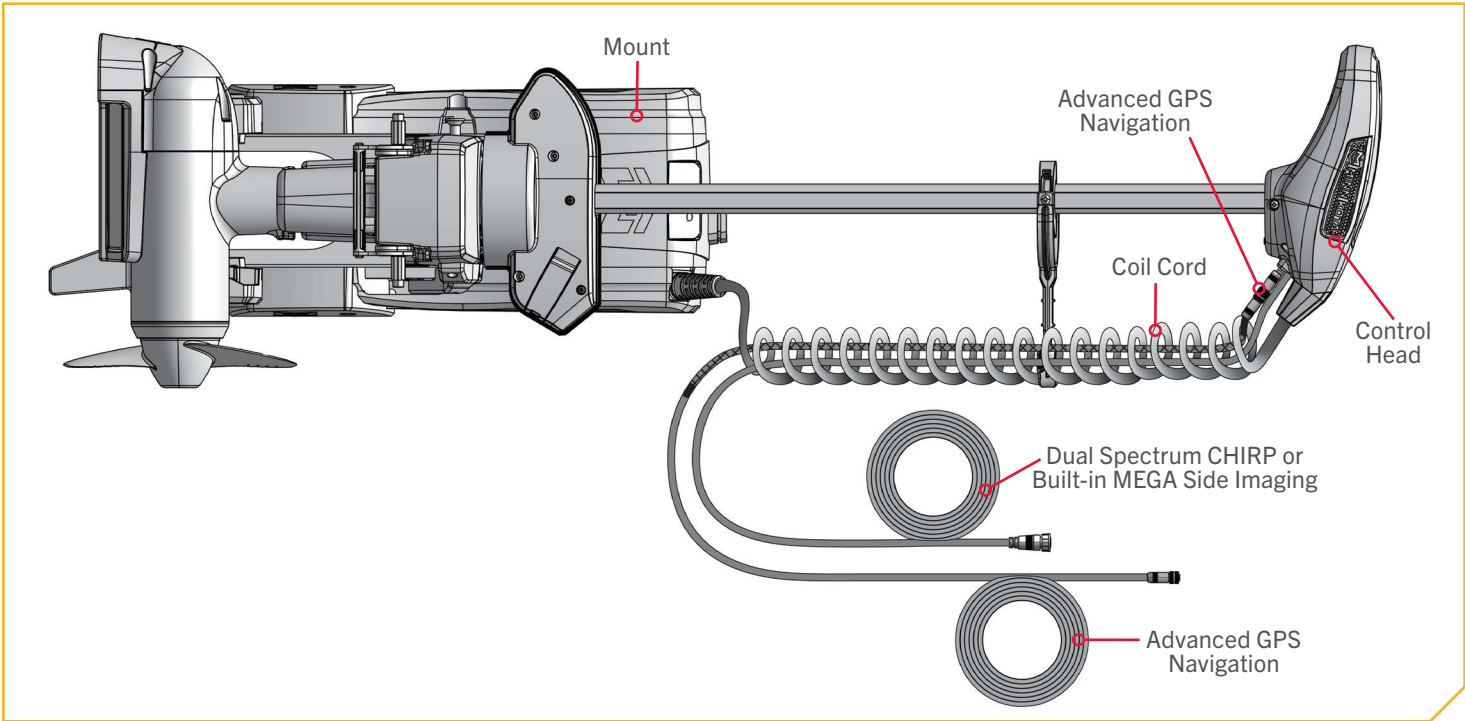

## CAUTION

Failure to follow the recommended wire routing for installed features, if equipped, may cause damage to the product and void your product warranty. Route cables away from pinch points or other areas that may cause them to bend in sharp angles. Routing the cables in any way other than directed may cause damage to the cables by being pinched or severed. Do not over-tighten the cable tie as it may damage the wire.



## 1

### ITEM(S) NEEDED

 #17 x 1

- a. Place the motor in the stowed position.

**NOTICE:** For instructions on stowing the Ultrera QUEST, see the “Quick Stow & Deploy” section of this manual.

- b. Confirm all Accessory Cables are connected to an output device as desired. With the motor stowed, locate the Advanced GPS Ethernet Connector below the Control Head.
- c. Take a Cable Tie (Item #17) and secure the Ethernet Cable to the second coil of the Coil Cord. The Cable Tie should wrap around the Ethernet Cable and Coil Cord, but not the Sonar Cable. Correct installation will have the Ethernet Cable and Sonar Cable each secured individually with a Cable Tie to the second coil of the Coil Cord.

**NOTICE:** The Sonar Cable comes from the factory secured to the Coil Cord with a Cable Tie. Do not remove or adjust the Cable Tie retaining the Sonar Cable.

- d. Secure the Cable Tie until it is fingertip tight. Do not over-tighten as it may damage the Ethernet Cable.
- e. Leave 6” of slack where the Sonar and Ethernet Cables exit the Coil Cord. Bundle any excess cable in a loose loop no less than 4” in diameter. The Reusable Cable Tie can be used to secure excess cable.

## CAUTION

Do not over-tighten the Cable Tie as it may damage the wires.

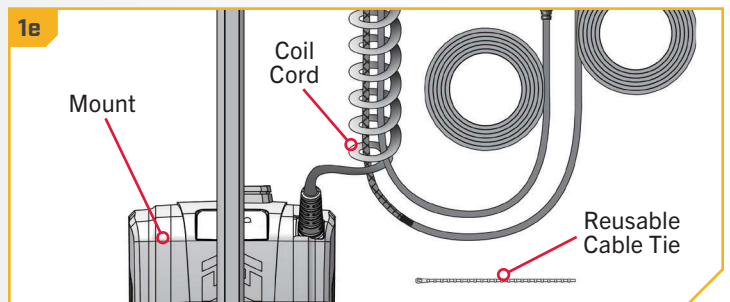
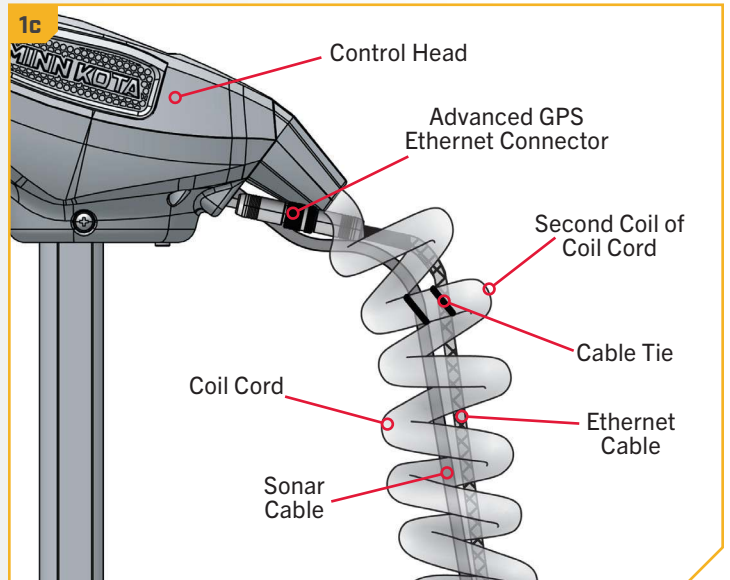

**NOTICE:** Minn Kota recommends routing the Accessory Cables through the Coil Cord. Bypassing the Coil Cord when routing Accessory Cables is not recommended.

**NOTICE:** The Ethernet Cable should be secured to the second coil of the Coil Cord. Securing the Ethernet Cable to any other coil may damage the Cables.

# INSTALLING THE PROP

## › Installing the Prop

1

### ITEM(S) NEEDED

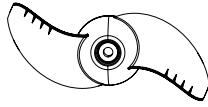

#10 x 1



#11 x 1



#12 x 1



#13 x 1



## CAUTION

Disconnect the motor from the battery before beginning any prop work or maintenance.

- Take the Drive Pin (Item #13) and slide it through the Hole in the Armature Shaft. Position the Drive Pin horizontally by grasping the Armature Shaft and rotating it with the Drive Pin in place.
- Align the Prop (Item #10) so it is horizontal and parallel with the Drive Pin. Slide the Prop onto the Armature Shaft and Drive Pin until it is seated against the lower unit.
- Install the Prop Washer (Item #11) and the Prop Nut (Item #12) onto the end of the Armature Shaft.
- While holding the Prop horizontal, tighten the Prop Nut with a 9/16" Deep Well Socket. Tighten the Prop Nut to 25-35 in-lbs.



## CAUTION

Do not over-tighten as this can damage the Prop.

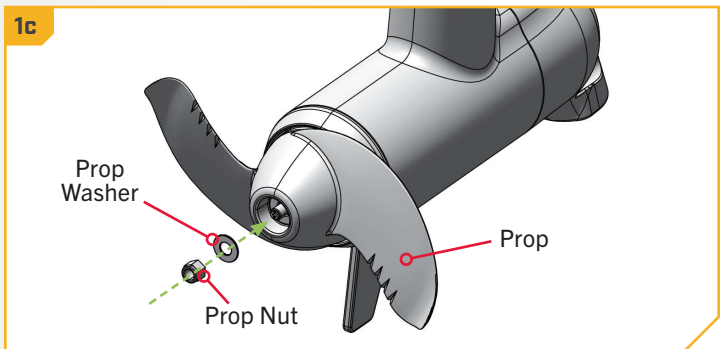
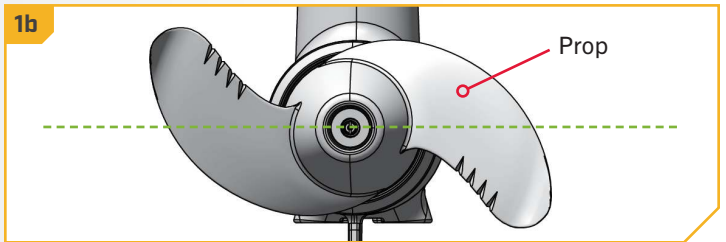
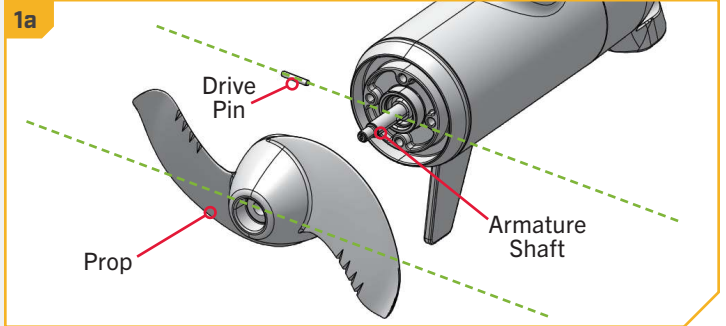

# ONE-BOAT NETWORK

## OPTIMIZING THE PERFORMANCE OF THE ULTERRA QUEST WITH THE WIRELESS REMOTE OR ONE-BOAT NETWORK APP

Minn Kota® and Humminbird® have joined forces to bring you the One-Boat Network, including the latest Advanced GPS Navigation Wireless Remote and the One-Boat Network app. The Wireless Remote comes from the factory paired to the trolling motor. To learn more about Wireless Remote features, refer to the Wireless Remote Owner's Manual online at [minnkota.johnsonoutdoors.com](http://minnkota.johnsonoutdoors.com).

To get the most from your One-Boat Network, we encourage you to download the One-Boat Network app onto your smart device. The One-Boat Network® app is a free iOS and Android application that you can download to a mobile device, providing unparalleled control over all of your One-Boat Network connected products. Minn Kota recommends connecting the trolling motor to the OBN app to assist in these steps. For instructions on pairing the OBN app to the trolling motor, refer to the OBN Quick Start Guide included with the motor. For more information on the OBN app, refer to the One-Boat Network Owner's Manual online at [minnkota.johnsonoutdoors.com](http://minnkota.johnsonoutdoors.com).

Completing the installation of the Ulterra QUEST through the Wireless Remote or OBN app should be done following the Prop installation. Ensure that the trolling motor is connected to a power source before adjusting One-Boat Network settings.

### **WARNING**

Take care that neither you nor other persons approach the turning propeller too closely, neither with body parts nor with objects. The motor is powerful and may endanger or injure you or others. Stay clear of the Prop and watch out for accidental engagement.

**NOTICE:** Ensure that the trolling motor is connected to a power source before adjusting One-Boat Network settings.

**NOTICE:** If the Wireless Remote is lost or becomes non-functioning during navigation, and the One-Boat Network app is unavailable, disconnect the motor from power to cancel all active navigation and turn off the Prop.

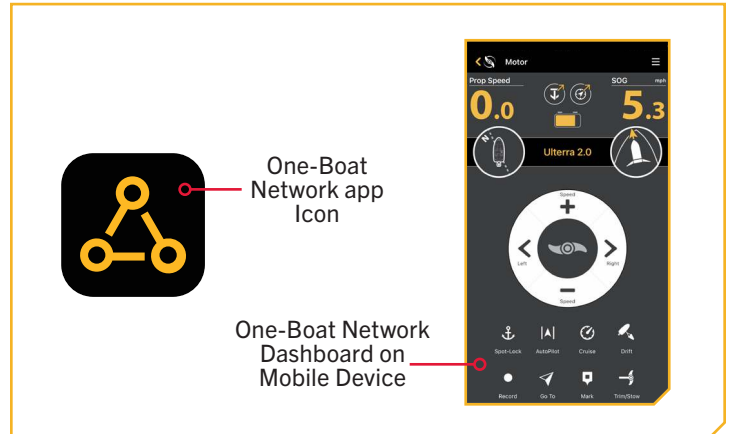

# ONE-BOAT NETWORK ADJUSTMENTS

## ONE-BOAT NETWORK ADJUSTMENTS



### KEEL OFFSET

The UltraQuest comes from the factory with the Lower Unit parallel to the Mount. When the Lower Unit is parallel to the Mount, the Keel Offset is zero. In an ideal installation, the Lower Unit will be parallel to the Keel; however, the Mount is rarely installed to be perfectly inline with the Keel, therefore the Lower Unit will not be parallel with the Keel. Nearly all installations will have some variation in mounting position to either the Port or Starboard side of the boat. The Keel Offset feature records the position of the Lower Unit when it is parallel to the Keel based on the Mount being offset from the Keel. Before adjusting the Keel Offset, complete all installation steps. This includes mounting the trolling motor to the boat and installing power and accessory cables. The Keel Offset can be recorded through the Wireless Remote or One-Boat Network App.

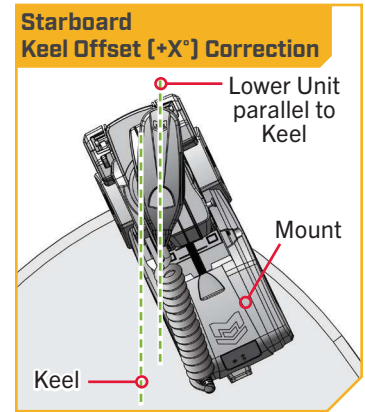
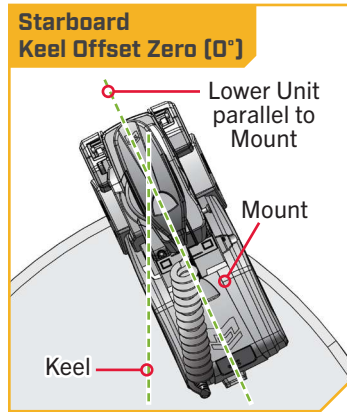
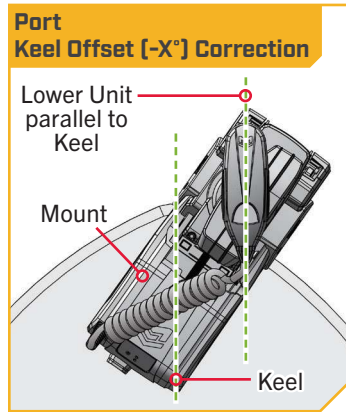
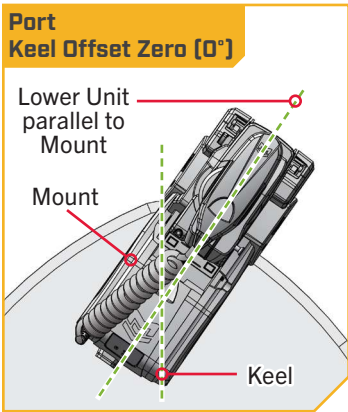
**NOTICE:** When the motor is installed from the factory, the Keel Offset is 0 degrees. When adjusting the Keel Offset, any position towards Port will create a Keel Offset of a negative angle. Any position towards Starboard will create a positive angle.







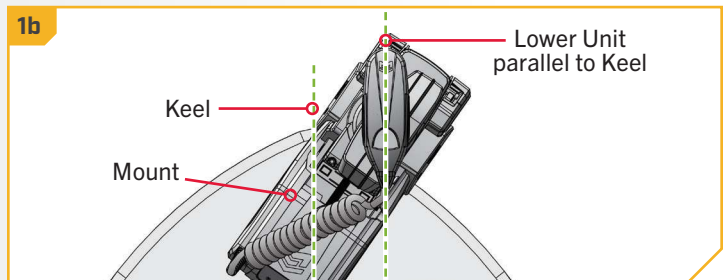
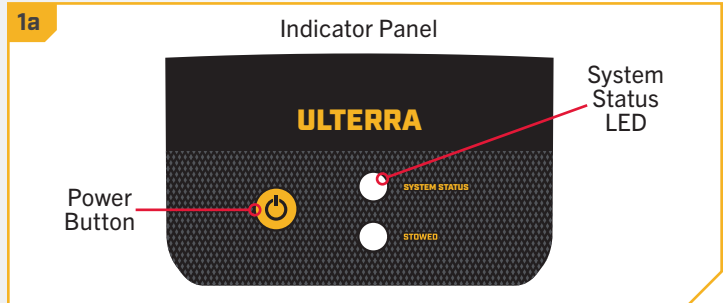



### Setting the Keel Offset with the Wireless Remote

- 1
  - a. Power on the trolling motor by pressing the Power  button on the Indicator Panel. When the trolling motor is on, the System Status  LED will be blue.
  - b. With either the Wireless Remote, foot pedal, or One-Boat Network (OBN) app on a paired mobile device, steer the motor so that the control head and lower unit are parallel to the Keel.







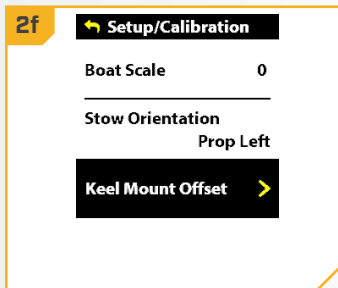
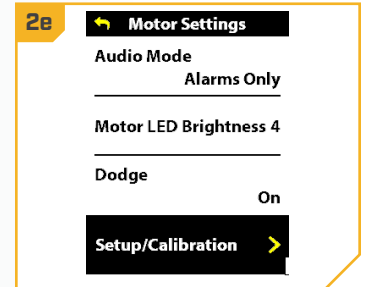
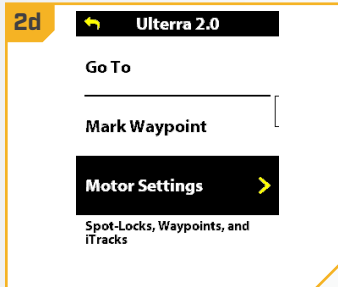

## 2

- c. Press the Menu  button on the Wireless Remote.
- d. Use the Speed Up  or Speed Down  button to find the Motor Settings menu. Use the Steer Right  button to select Motor Settings.
- e. In the Motor Settings Menu, use the Speed Up  or Speed Down  button to find Setup/Calibration.
- f. In the Setup/Calibration menu, use the Speed Up  or Speed Down  button to find Keel Mount Offset. Use the Steer Right  button to select Keel Mount Offset.



## 3

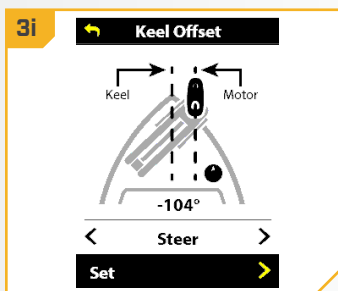
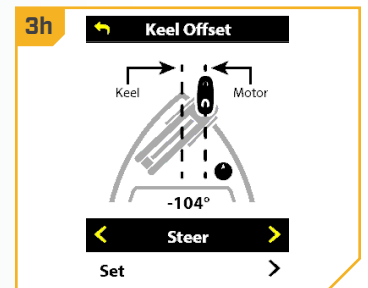
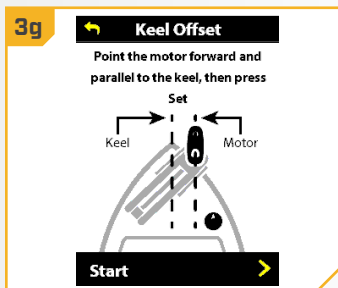

- g. Review all safety warnings. Use the Steer Right  button to select Start and begin the process.
- h. Use the Steer Left  or Steer Right  button to point the motor forward and parallel to the keel.
- i. When satisfied with the placement of the trolling motor, use the Speed Up  or Speed Down  button to scroll to Set. Use the Steer Right  button to select Set. The degree of offset is displayed at the bottom of the Dashboard.



# KEEL OFFSET

## ▶ Setting the Keel Offset with the One-Boat Network App

1

- a. Power on the trolling motor by pressing the Power  button on the Indicator Panel. When the trolling motor is on, the System Status  LED will be blue.
- b. With either the Wireless Remote, foot pedal, or One-Boat Network (OBN) app on a paired mobile device, steer the motor so that the control head and lower unit are parallel to the Keel.

1a

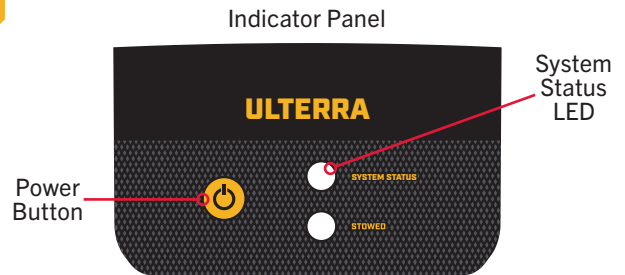

1b

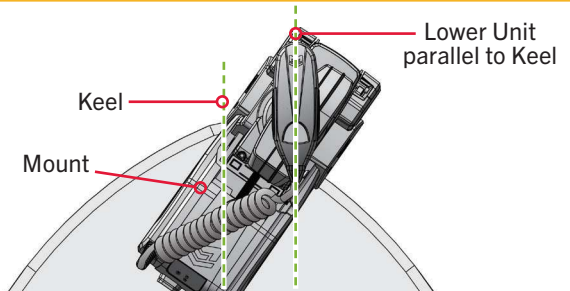

2

- c. Open the One-Boat Network (OBN) app on the mobile device. Make sure the mobile device is paired with the trolling motor.
- d. From the OBN home screen, tap the Motor menu. The Motor menu opens the Motor home screen.
- e. Before the Motor home screen will open, tap Agree on the on-screen prompt.

**NOTICE:** The on-screen prompt will only display once each time the app is launched. If the prompt has displayed, the Motor home screen appears.

- f. On the Motor home screen, locate the Motor Settings button in the upper-right corner and tap it.

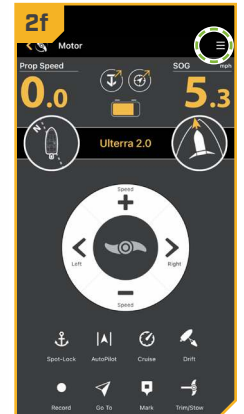
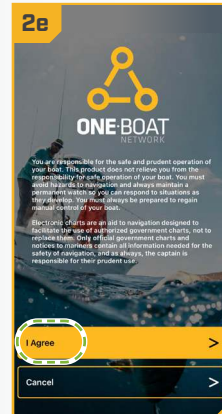
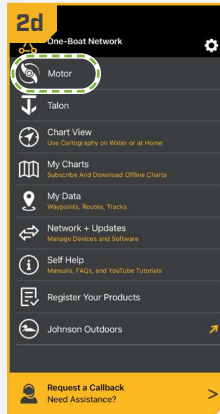

## 3

- g. In the Motor Settings menu, find and tap Setup and Calibration.
- h. In Setup and Calibration, find and tap Keel Mount Offset.
- i. Review all safety warnings. Follow the prompts in the One-Boat Network app. If the placement of the trolling motor is pointing forward and parallel to the keel, tap Set. The degree of offset will show at the bottom of the app Display.

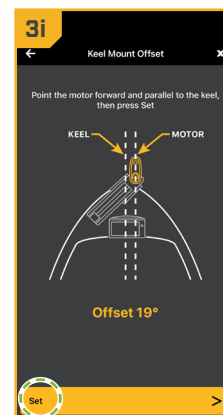
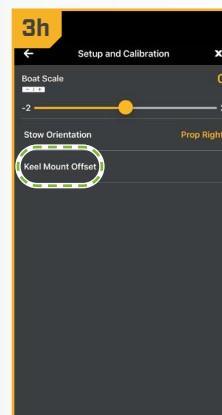
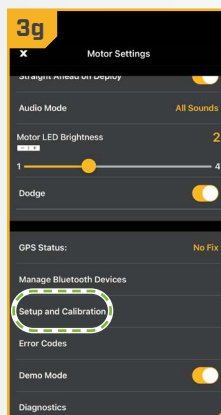

## 4

- j. If the trolling motor needs to be adjusted, locate the Return button on the upper-left corner of the app screen. Tap the Return button three times until the Motor home screen displays.
- k. Use the Steer Right > and Steer Left < buttons to point the motor forward and parallel to the keel.
- l. When satisfied with the placement of the trolling motor, locate the Motor Settings button in the upper-right corner and tap it.
- m. In the Motor Settings menu, find and tap Setup and Calibration.
- n. In Setup and Calibration, find and tap Keel Mount Offset. If the placement of the trolling motor is pointing forward and parallel to the keel, tap Set.
- o. The degree of offset shows at the bottom of the app Display. Tap Return to close the Keel Mount Offset and return to the home screen.

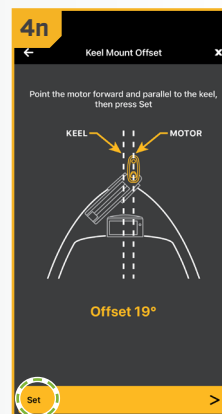
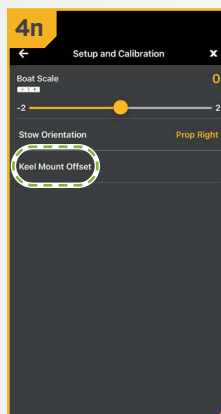
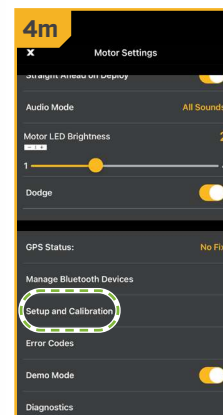

# STRAIGHT ON DEPLOY





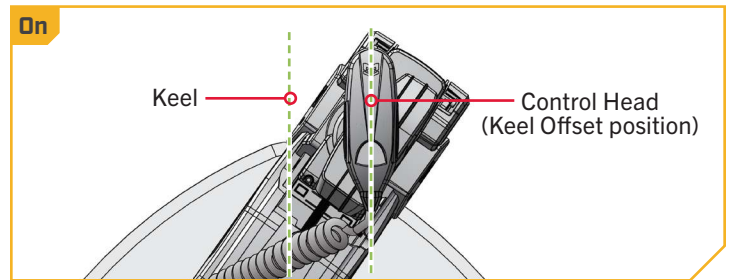
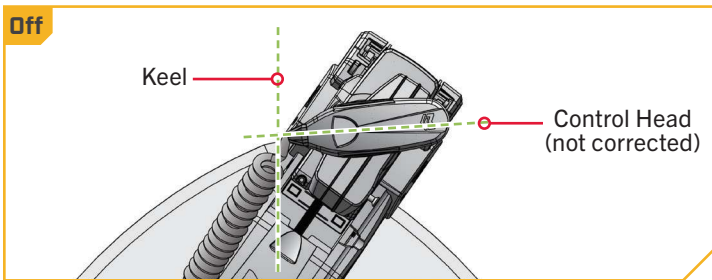

## STRAIGHT ON DEPLOY

Minn Kota recommends setting the Keel Offset when the position of the Lower Unit is parallel with the Keel. Save the Keel Offset before exploring the Straight on Deploy feature. Straight on Deploy uses the position recorded in Keel Offset to know where to position the Lower Unit to be parallel with the Keel.

When Straight on Deploy is engaged, the lower unit will automatically rotate to the Keel Offset position when deployed. By default, the Lower Unit will be parallel to the Keel when the Mount is parallel to the Keel. If the Keel Offset was programmed to another angle, the Straight on Deploy feature will correct the position to match the Keel Offset angle when turned "on." If Straight on Deploy is turned "off," the trolling motor will not correct the position in any direction.



### › To Toggle Straight on Deploy with the Wireless Remote

- 1
  - a. With the motor on, press the Menu  button on the Wireless Remote.
  - b. Use the Speed Up  or Speed Down  button to find the Motor Settings menu. Use the Steer Right  button to select Motor Settings.
  - c. In the Motor Settings Menu, use the Speed Up  or Speed Down  button to find Straight on Deploy.
  - d. By default, the Straight on Deploy is toggled "off."
  - e. Use the Steer Right  button to toggle between "on" and "off."

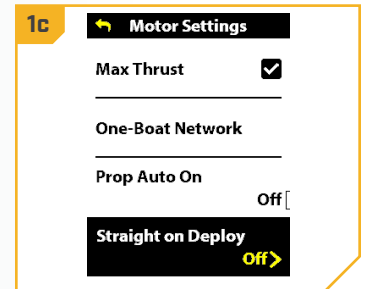
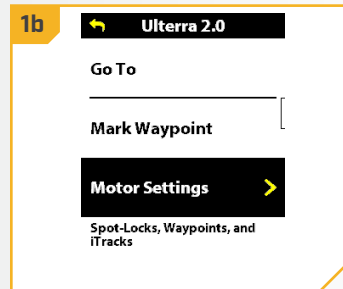



► To Toggle Straight on Deploy with the One-Boat Network App

1

- a. Open the One-Boat Network (OBN) app on a mobile device. Make sure the mobile device is paired with the trolling motor and that the motor is powered "on."
- b. From the OBN home screen, tap the Motor menu. The Motor menu opens the Motor home screen.
- c. Before the Motor home screen will open, tap Agree on the on-screen prompt.

**NOTICE:** The on-screen prompt will only display once each time the app is launched. If the prompt has displayed, the Motor home screen appears.

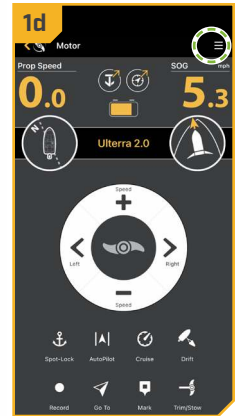
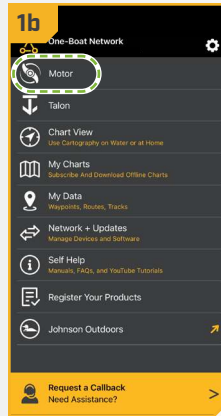

- d. On the Motor home screen, locate the Motor Settings button in the upper-right corner and tap it.

2

- e. In the Motor Settings menu, find the Straight Ahead on Deploy toggle. Tap to turn the toggle "on" and "off." When highlighted yellow the toggle is "on."

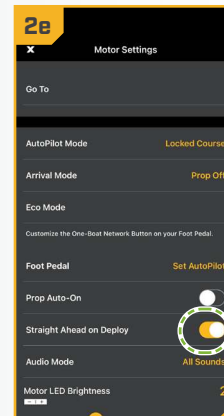
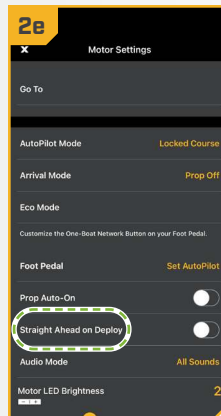

# STOW ORIENTATION

## STOW ORIENTATION

The Stow Orientation is a term used to describe the lower unit and Prop position when the motor is stowed. The lower unit will automatically rotate into the Stow Orientation when stowing the motor. The Stow Orientation can be set to Prop Left or Prop Right through the Wireless Remote or One-Boat Network app. The factory default setting for the lower unit is Prop Left. Adjusting the Stow Orientation allows the installation to be customized to fit boat positioning for either a Port or Starboard installation and to accommodate fishing or trailering applications.

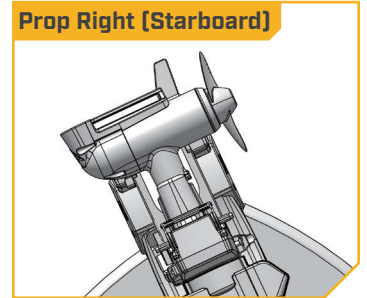
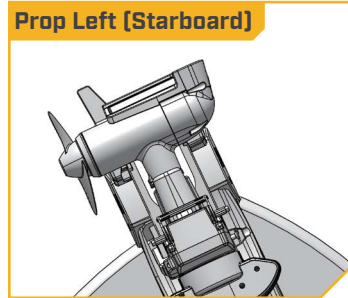
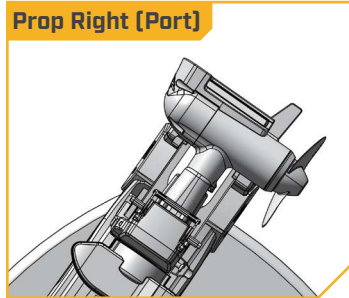
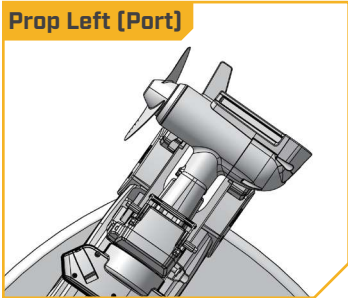

### Setting the Stow Orientation with the Wireless Remote

- 1**
  - a. With the trolling motor powered on, press the Menu button on the Wireless Remote.
  - b. Use the Speed Up or Speed Down button to find the Motor Settings menu. Use the Steer Right button to select Motor Settings.
  - c. In the Motor Settings Menu, use the Speed Up or Speed Down button to find Setup/Calibration. Use Steer Right to open the Setup/Calibration menu.

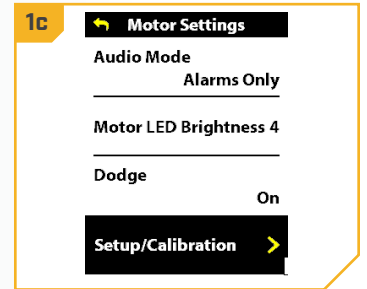
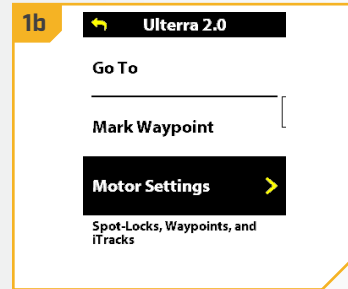

- 2**
  - d. Once in the Setup/Calibration menu, use the Speed Up or Speed Down button to find Stow Orientation. Use Steer Right to open the Stow Orientation menu.
  - e. In the Stow Orientation menu, use the Speed Down or Speed Up button to scroll between Prop Left and Prop Right. Use the Steer Right button to select the desired stow orientation.

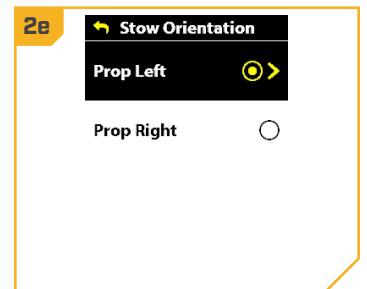
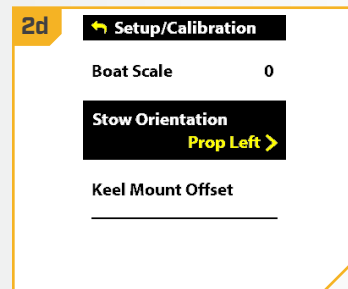

## ▶ Setting the Stow Orientation with the One-Boat Network App

1

- Open the One-Boat Network (OBN) app on a mobile device. Make sure the mobile device is paired with the trolling motor and that the motor is powered "on."
- From the OBN home screen, tap the Motor menu. The Motor menu opens the Motor home screen.
- Before the Motor home screen will open, tap Agree on the on-screen prompt.

**NOTICE:** The on-screen prompt will only display once each time the app is launched. If the prompt has displayed, the Motor home screen appears.

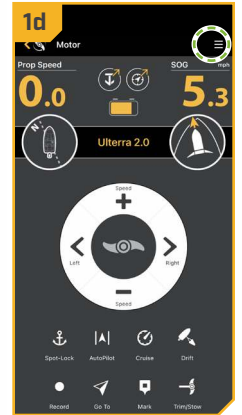
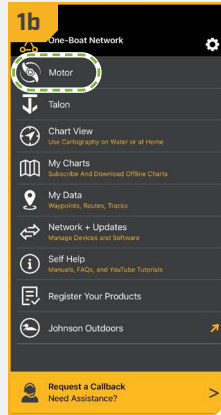

- On the Motor home screen, locate the Motor Settings button in the upper-right corner and tap it.

2

- In the Motor Settings menu, find and tap Setup and Calibration.
- In Setup and Calibration, find and tap Stow Orientation.
- Set the feature to Prop Right or Prop Left.

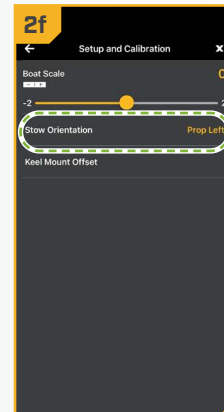
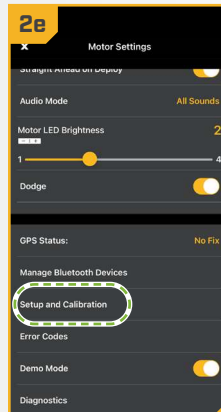







# BOAT SCALE

## BOAT SCALE





Trolling motor performance can be impacted by factors including, but not limited to, wind, water conditions, boat specifications, battery health, wiring, etc. Boat Scale provides a method of adjusting how the trolling motor will perform to account for these and other variables. The Ulterra QUEST comes from the factory with Boat Scale set to zero. Boat Scale can be adjusted up (+2) or down (-2) to increase or decrease how the motor control software applies power while using a navigation mode like Spot-Lock.

An example showing the need to reduce Boat Scale would be while using Spot-Lock and the motor is over-correcting or making frequent adjustments. In this case, try reducing Boat Scale -1 to reduce this behavior. If the behavior continues, reduce Boat Scale to -2. An example showing the need to increase Boat Scale while using Spot-Lock would be the motor is drifting away from its target location frequently or needs help to make corrections. Try increasing Boat Scale to +1 to help improve the trolling motor accuracy in this case. If the behavior continues, increase Boat Scale to +2.

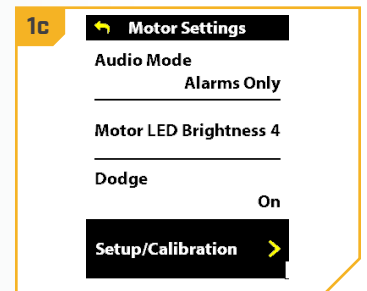
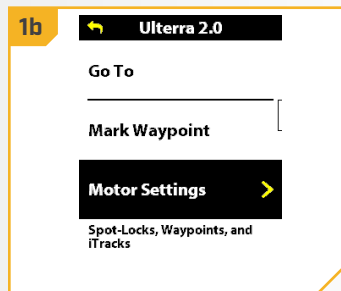
### Adjusting Boat Scale with the Wireless Remote

- 1**
  - a. With the motor on, press the Menu  button on the Wireless Remote.
  - b. Use the Speed Up  or Speed Down  button to find the Motor Settings menu. Use the Steer Right  button to select Motor Settings.
  - c. In the Motor Settings Menu, use the Speed Up  or Speed Down  button to find Setup/Calibration.



- 2**
  - d. Once in the Setup/Calibration menu, use the Speed Up  or Speed Down  button to find Boat Scale.
  - e. Use the Steer Left  or Steer Right  button to adjust the Boat Scale to one of the five settings: -2, -1, 0, 1 or 2.

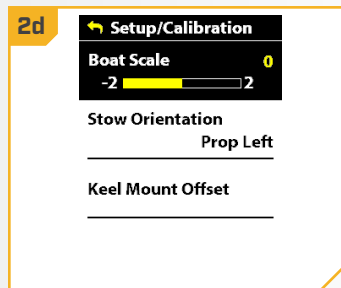

## Adjusting Boat Scale with the One-Boat Network App

1

- a. Open the One-Boat Network (OBN) app on a mobile device. Make sure the mobile device is paired with the trolling motor and that the motor is powered "on."
- b. From the OBN home screen, tap the Motor menu. The Motor menu opens the Motor home screen.
- c. Before the Motor home screen will open, tap Agree on the on-screen prompt.

**NOTICE:** The on-screen prompt will only display once each time the app is launched. If the prompt has displayed, the Motor home screen appears.

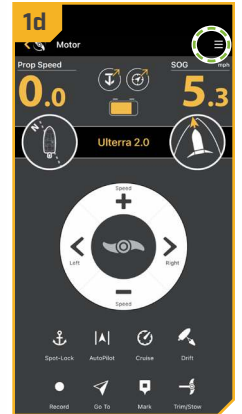
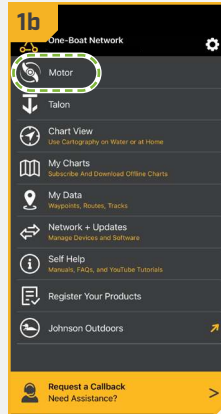

- d. On the Motor home screen, locate the Motor Settings button in the upper-right corner and tap it.

2

- e. In the Motor Settings menu, find and tap Setup and Calibration.
- f. In Setup and Calibration, find and tap Boat Scale.
- g. Set the feature to increase or decrease Boat Scale.

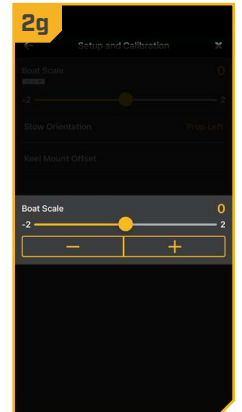
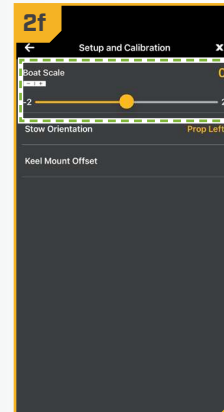
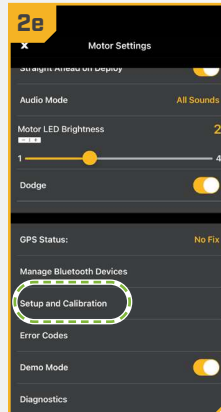

# ONE-BOAT NETWORK BUTTONS



## ONE-BOAT NETWORK BUTTONS >





Minn Kota trolling motors equipped with Advanced GPS Navigation are compatible with devices enabled with the One-Boat Network (OBN), such as the Wireless Remote and Foot Pedal. OBN functions can be enabled and disabled through customizable OBN buttons on the Wireless Remote and Foot Pedal. The function of the OBN buttons can be customized based on user preference to enhance operation of the OBN product. Customizable OBN buttons include:

1. The four One-Boat Network buttons on the Wireless Remote
2. The One-Boat Network button on the Foot Pedal

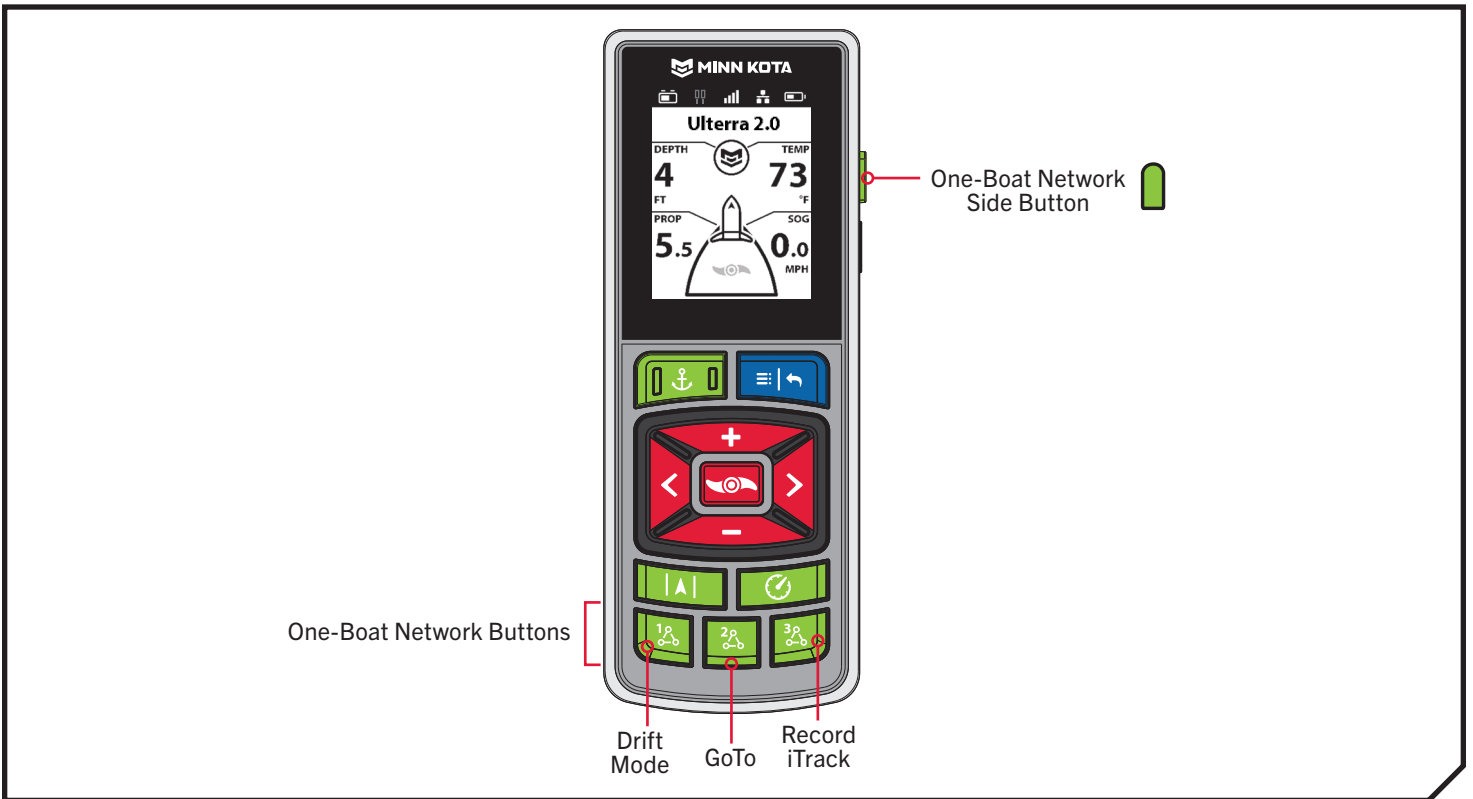

## CUSTOMIZING THE ONE-BOAT NETWORK BUTTONS ON THE WIRELESS REMOTE









One-Boat Network Default Buttons			
	Drift Mode		Record iTrack
	GoTo		Deployment Mode

# CUSTOMIZING THE ONE-BOAT NETWORK BUTTONS ON THE WIRELESS REMOTE



One-Boat Network functions can be enabled and disabled through four One-Boat Network buttons on the Wireless Remote. The One-Boat Network buttons can be customized to control the following functions, depending on your setup:











Function	Icon	Description
Drift Mode		Drift mode is the default function for OBN Button 1. Press once to engage Drift Mode. Press a second time to Adjust Course.
Go To		Go To is the default for the OBN Button 2. Press once to open the Go To Menu. The Go To options are Spot-Locks, Waypoints, iTracks and Drift.
Record iTrack		Record iTrack is the default function for OBN Button 3. Press once to start recording an iTrack. Press a second time to save the iTrack.
Waypoint		Mark Waypoint must first be customized to one of the OBN buttons. Press once to save a Waypoint.
Max Speed		Max Speed must first be customized to one of the OBN buttons. Double press to engage Max Speed. Single press to return to the previous speed.
Talon/Raptor		The shallow water anchor function must first be customized to one of the OBN buttons. The shallow water anchor function will display as Talon or Raptor depending on your configuration. Double press to deploy the anchor. Press once to pause or stow the anchor.
Deployment Mode		Deployment Mode is the default function for the OBN Side Button on trolling motors with a stow/deploy and trim function. The Deployment Mode function will display as Ulterra. Press the OBN Side Button once to bring up the Ulterra menu.



# CUSTOMIZE THE ONE-BOAT NETWORK BUTTONS ON THE WIRELESS REMOTE





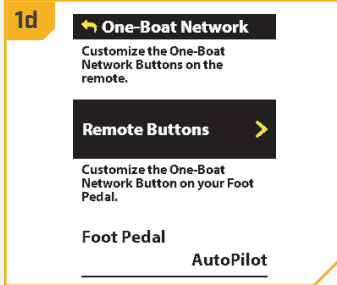
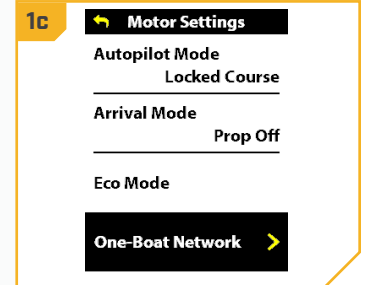
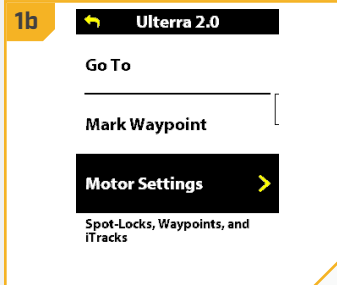

## › Customize the One-Boat Network Buttons on the Wireless Remote

1

- On the Wireless Remote, press the Menu  button to open the Motor Menu.
- In the Motor Menu, use the Speed Down  or Speed Up  button to find the Motor Settings menu. Use the Steer Right  button to select Motor Settings.
- In the Motor Settings menu, use the Speed Down  or Speed Up  button to find One-Boat Network. Use the Steer Right  button to select One-Boat Network.
- In the One-Boat Network Menu, use the Speed Down  or Speed Up  button to find Remote Buttons. Use the Steer Right  button to select Remote Buttons.



2

- Use the Speed Down  or Speed Up  button to highlight the OBN button to customize. There are four options: Button 1, Button 2, Button 3 or Side Button. Press the Steer Right  button to make the selection.
- Use the Speed Down  or Speed Up  button to scroll through the options. Use the Steer Right  button to select the function.

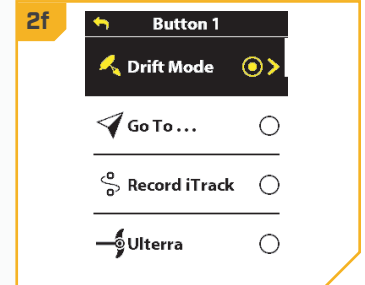
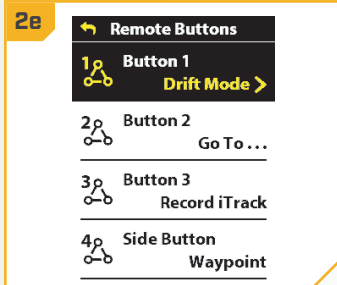

**NOTICE:** The radio button next to the desired function will be selected when the Steer Right  button is used to customize the function. The function options listed are based on the trolling motor and other devices in the Advanced GPS Navigation network.

**NOTICE:** For quick customization, press and hold the OBN button you want to customize to quickly bring up the customization screen.

- Press and hold the Menu  button to close and return to the Home Screen.



# CUSTOMIZING THE ONE-BOAT NETWORK BUTTON ON THE FOOT PEDAL

## CUSTOMIZING THE ONE-BOAT NETWORK BUTTON ON THE FOOT PEDAL



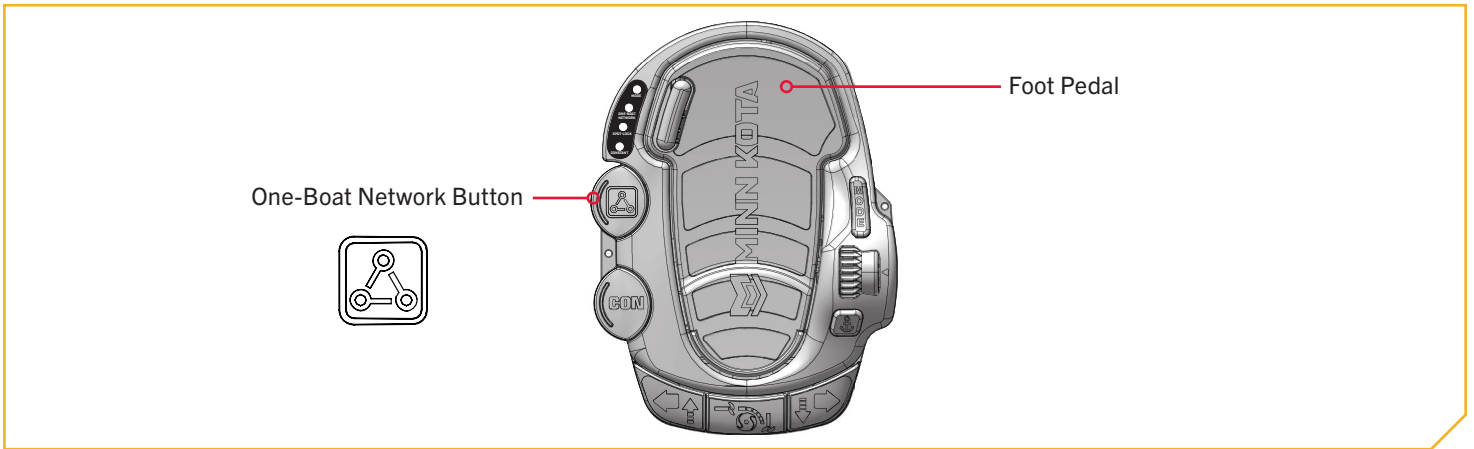



Minn Kota trolling motors equipped with Advanced GPS Navigation are compatible with devices enabled with the One-Boat Network, such as the Foot Pedal. One-Boat Network functions are enabled and disabled through the Foot Pedal with the One-Boat Network  button. This button can be customized using either the Wireless Remote or the One-Boat Network app on a paired mobile device.



The One-Boat Network  button on the Foot Pedal can be customized to control the following functions:

Function	Operation	LED Indication
AutoPilot (default)	Engage and disengage AutoPilot	Red LED will illuminate when AutoPilot is engaged and stay on until disengaged.
Waypoint	Mark a Waypoint	Red LED will illuminate when the One-Boat Network button is pressed and then turn off, signaling that a Waypoint was marked.
Shallow Water Anchor (Raptor/Talon)	Deploy and retract a Raptor/Talon	Red LED will steadily flash when the Shallow Water Anchor is deploying or stowing. Red LED will stay illuminated when the anchor is at any state of deployment, including when it is paused. Red LED will turn off when the anchor is fully stowed.





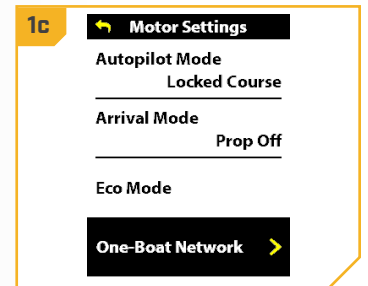
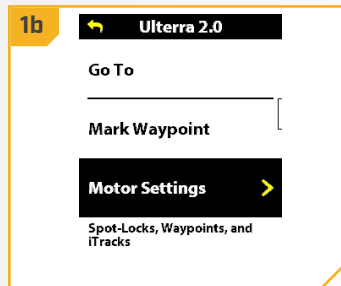

## › Customize the OBN Button on the Foot Pedal with the Wireless Remote

- 1**
  - a. With the trolling motor powered on, press the Menu  button on the Wireless Remote.
  - b. In the Motor Menu, use the Speed Down  or Speed Up  button to find the Motor Settings menu. Use the Steer Right  button to select Motor Settings.
  - c. In the Motor Settings menu, use the Speed Down  or Speed Up  button to find One-Boat Network. Use the Steer Right  button to select One-Boat Network.



# CUSTOMIZING THE ONE-BOAT NETWORK BUTTON ON THE FOOT PEDAL

2

- d. In the One-Boat Network menu, use the Speed Down  or Speed Up  button to find Foot Pedal. Use the Steer Right  button to select Foot Pedal.
- e. In the Foot Pedal menu, use the Speed Down  or Speed Up  button to find the desired function. Use the Steer Right  button to select the function.
- f. Press and hold the Menu  button to close and return to the Home Screen.

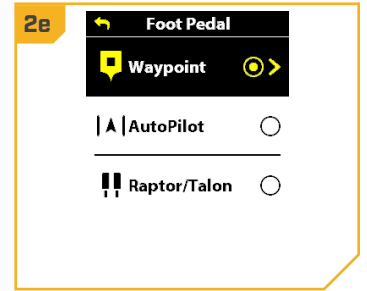
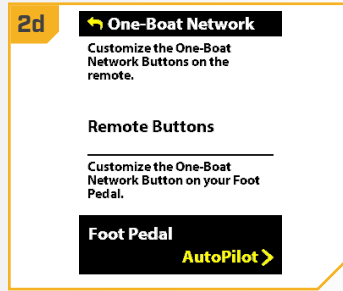

**NOTICE:** The radio button next to the desired function will be selected when the Steer Right  button is used to customize the function. AutoPilot is the default selection for Ulterra QUEST trolling motors. The function options listed are based on the trolling motor and other devices in the Advanced GPS Navigation network.

## Customize the OBN Button on the Foot Pedal with the One-Boat Network App

1

- a. Open the One-Boat Network (OBN) app on a mobile device. Make sure the mobile device is paired with the trolling motor and that the motor is powered “on.”
- b. From the OBN home screen, tap the Motor menu. The Motor menu opens the Motor home screen.
- c. Before the Motor home screen will open, tap Agree on the on-screen prompt.

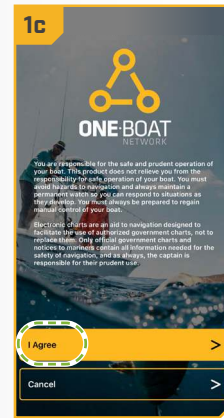
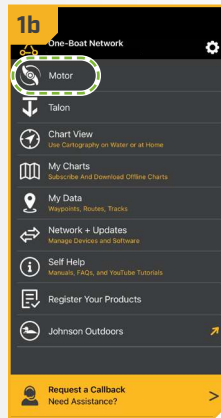

**NOTICE:** The on-screen prompt will only display once each time the app launches. If the prompt has been displayed, the Motor home screen appears.

2

- d. On the Motor home screen, locate the Motor Settings button in the upper-right corner and tap it.
- e. In Motor Settings, locate Foot Pedal and tap it.
- f. In the Foot Pedal menu, tap the desired function. The radio button next to the selected function will be highlighted.

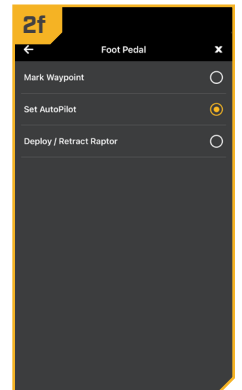
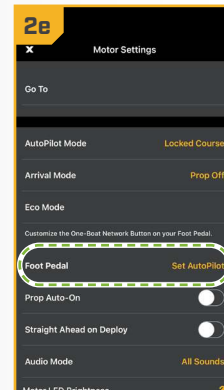

# QUICK STOW & DEPLOY

## STOWING AND DEPLOYING THE ULTERRA QUEST





The Ulterra® QUEST gives you push-button command from anywhere on the boat. Stow, deploy or trim the motor up and down by using the buttons on your Advanced GPS Navigation Wireless Remote, Foot Pedal, One-Boat Network app, or a connected Humminbird® fish finder. It's instant. Effortless. And it makes Ulterra QUEST the easiest-to-use motor on the water.



Use the following procedures to stow and deploy the motor. If the motor stalls when attempting to stow, the motor may be encountering an error. Check for obstructions or low motor batteries. If the batteries are too low to fully stow the motor, re-engage power, deploy the motor, trim the lower unit to its highest setting, and turn power off until batteries can be recharged. Once batteries are charged, attempt to stow the motor again.

### STOW & DEPLOY >

## STOWING AND DEPLOYING WITH THE WIRELESS REMOTE

### > Deploying with the Wireless Remote

- 1
  - a. Press the Power  button on the Wireless Remote.
  - b. Use the Speed Up  or Speed Down  button to find Ulterra.
  - c. Press the Steer Right  button to select Ulterra and open Deployment Mode.

**NOTICE:** Alternatively, press the One-Boat Network  side button to quickly access Deployment Mode. The function of the OBN  side button is set by default to open the Ulterra Deployment Mode menu.

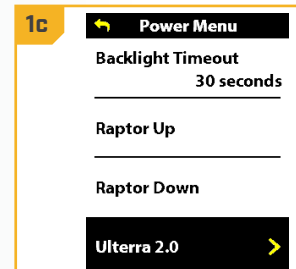
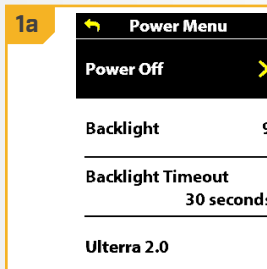

**NOTICE:** The Wireless Remote comes from the factory paired to the Ulterra QUEST.

# STOWING WITH THE WIRELESS REMOTE



2

- d. Press the Steer Right  button to select Deploy. The motor will automatically deploy.



## WARNING

As soon as Deploy is selected, the motor will automatically deploy. Be sure that the motor is clear from obstructions and has a clear path of travel. The Prop is disabled while the motor is stowing or deploying to prevent accidental contact with the rotating Prop.



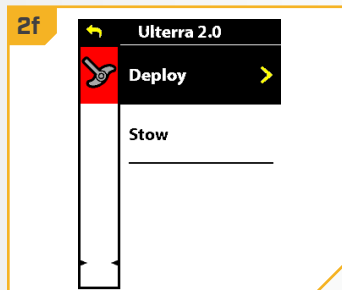
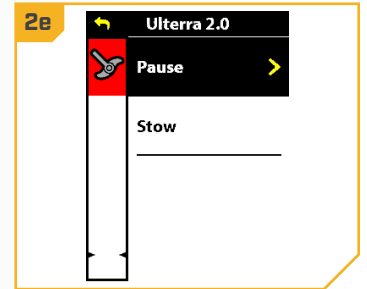
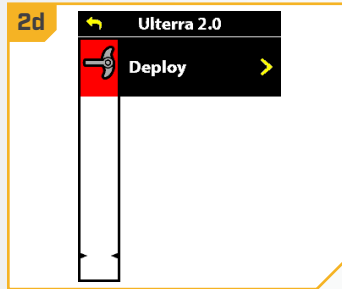

- e. While the Motor is deploying, it is possible to pause the action. To pause the action, press the Steer Right  button to select Pause.
- f. To resume the Deploy action, press the Steer Right  button to select Deploy.
- g. If the Motor continues, it will complete the deploy process and normal motor operation will follow.





**NOTICE:** To avoid churning or agitation of surface water, ensure that the top of the motor is submerged at least 12" below the surface of the water.

## › Stowing with the Wireless Remote

1

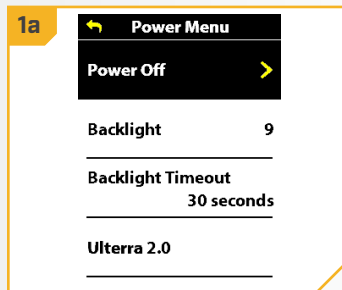

- a. Press the Power  button on the Wireless Remote.
- b. Use the Speed Up  or Speed Down  button to find Ulterra.
- c. Press the Steer Right  button to select Ulterra and open Deployment Mode.

**NOTICE:** Alternatively, press the One-Boat Network  side button to quickly access Deployment Mode. The function of the OBN  side button is set by default to open the Ulterra Deployment Mode menu.



## STOWING WITH THE WIRELESS REMOTE



2

- d. Use the Speed Up  or Speed Down  button to find Stow. Use the Steer Right  button to select it. Once selected, the motor will automatically stow, and the Prop will be disabled.



### WARNING

As soon as Stow is selected, the motor will automatically stow. Be sure the motor is clear from obstructions and has a clear path of travel. The Prop is disabled while the motor is stowing or deploying to prevent accidental contact with the rotating Prop.

- e. While the Motor is stowing, it is possible to pause the action. To pause the action, press the Speed Down  button to find Pause and press the Steer Right  button to select it.
- f. To resume the Stow action, press the Steer Right  button to select Stow.
- g. If the Motor continues, it will complete the Stow process and normal motor operation will follow.

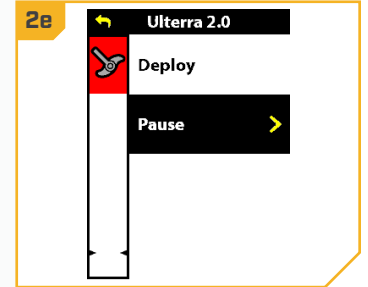
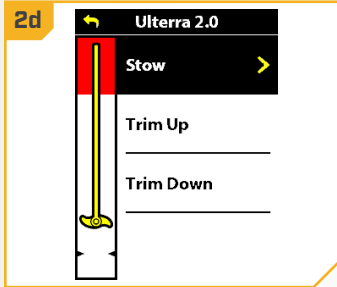

**NOTICE:** The Stow option is only displayed when the motor is deployed.



### WARNING

The motor is not safely stowed for transport until the orange STOWED  LED on the Indicator Panel is illuminated.

# DEPLOYING WITH THE OBN APP

## STOWING AND DEPLOYING WITH THE ONE-BOAT NETWORK (OBN) APP

### Deploying with the OBN App

- 1 a. Open the One-Boat Network (OBN) app on the mobile device. Make sure the mobile device is paired with the trolling motor.
- b. From the OBN home screen, tap the Motor menu. The Motor menu opens the Motor home screen.
- c. Before the Motor home screen will open, tap Agree on the on-screen prompt.

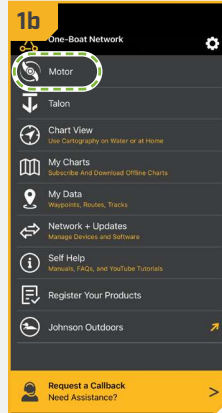

**NOTICE:** The on-screen prompt will only display once each time the app is launched. If the prompt has displayed, the Motor home screen appears after.

- 2 d. Tap Trim/Stow on the bottom of the screen to open the Trim/Stow/Deploy menu.
- e. Tap Deploy to automatically deploy the motor. Normal motor operation will follow.

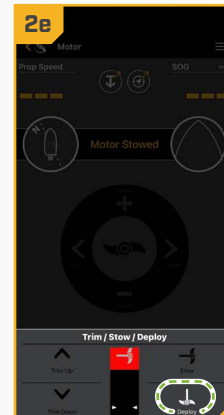

### WARNING

As soon as Deploy is tapped, the motor will automatically deploy. Be sure that the motor is clear from obstructions and has a clear path of travel. The Prop is disabled while the motor is stowing or deploying to prevent accidental contact with the rotating Prop.

**NOTICE:** While the motor is deploying, it is possible to stop the action by tapping Pause. To resume, tap the desired action.

**NOTICE:** To avoid churning or agitation of surface water, ensure that the top of the motor is submerged at least 12" below the surface of the water.

## › Stowing with the OBN App

1

- Open the One-Boat Network (OBN) app on the mobile device. Make sure the mobile device is paired with the trolling motor.
- From the OBN home screen, tap the Motor menu. The Motor menu opens the Motor home screen.
- Before the Motor home screen will open, tap Agree on the on-screen prompt.

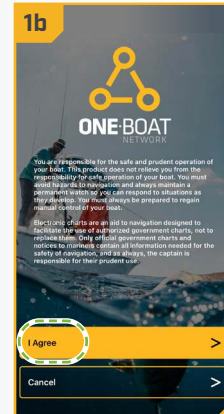
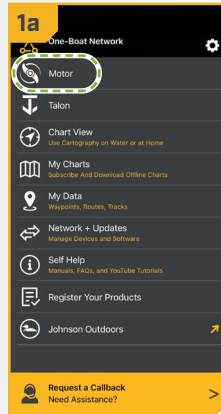

**NOTICE:** The on-screen prompt will only display once each time the app is launched. If the prompt has displayed, the Motor home screen appears after.

2

- Tap Trim/Stow on the bottom of the screen to open the Trim/Stow/Deploy menu.
- Tap Stow to automatically stow the motor. The Prop will be disabled and "Motor Stowed" will display on the screen.



### WARNING

As soon as Stow is tapped, the motor will automatically stow. Be sure the motor is clear from obstructions and has a clear path of travel. The Prop is disabled while the motor is stowing or deploying to prevent accidental contact with the rotating Prop.

**NOTICE:** While the motor is stowing, it is possible to stop the action by tapping Pause. To resume, tap the desired action.

### WARNING

The motor is not safely stowed for transport until the orange STOWED LED on the Indicator Panel is illuminated.

# STOWING AND DEPLOYING WITH THE FOOT PEDAL

## STOWING AND DEPLOYING WITH THE FOOT PEDAL

1

- a. On the Foot Pedal, press the MODE button so that the white MODE LED on the Indicator Panel is illuminated, putting the Foot Pedal in Deployment Mode.

**NOTICE:** The motor can only stow and deploy in Deployment Mode.

- b. To deploy the motor when it is stowed, double press the Stow/Deploy button. To stow the motor when it is deployed, single press the Stow/Deploy button.

### **WARNING**

When stowing or deploying the motor, keep fingers clear of all hinges, pivot points, and all moving parts. When stowing and deploying the motor, ensure that it doesn't contact the boat, trailer, or any other obstruction.

**NOTICE:** The **deploy** sequence can be stopped anytime by pressing the Stow/Deploy button. The **stow** sequence can be stopped at any time by pressing either the Trim Up or Trim Down button or the Stow/Deploy button.

**NOTICE:** To avoid churning or agitation of surface water, ensure that the top of the motor is submerged at least 12" below the surface of the water.

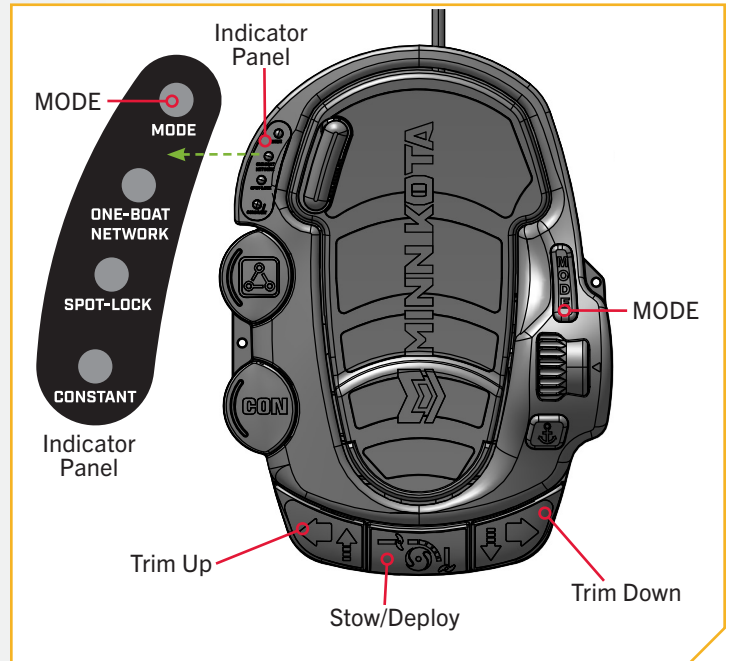

### **WARNING**

The motor is not safely stowed for transport until the orange STOWED LED on the Indicator Panel is illuminated.



# ADJUSTING THE DEPTH (TRIM) OF THE ULTERRA QUEST





## ADJUSTING THE DEPTH (TRIM) OF THE ULTERRA QUEST

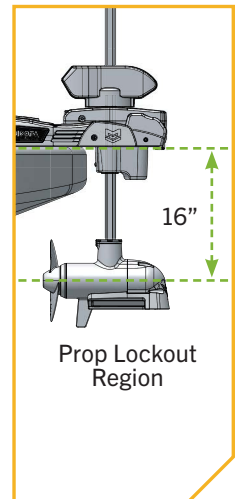
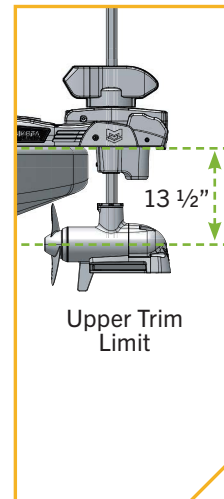
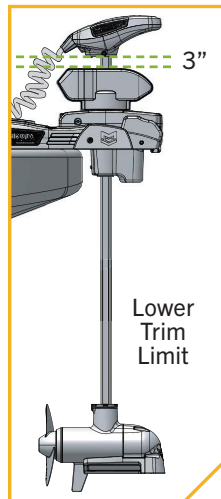
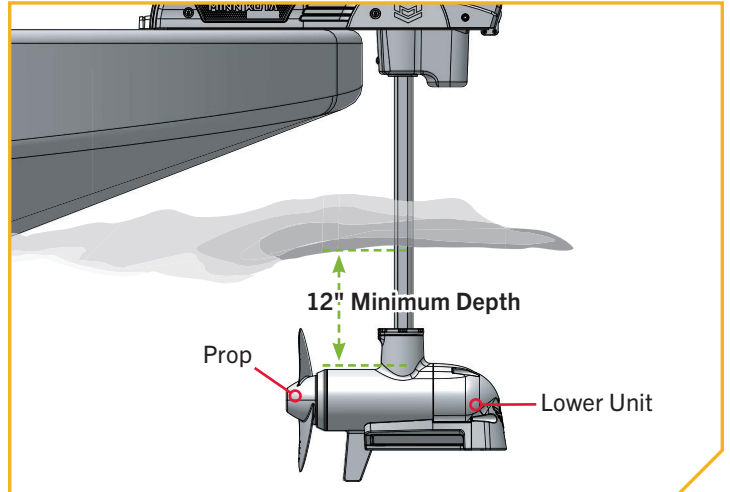

Once the boat is on the water, it may be necessary to adjust the trim of the Lower Unit up or down to achieve an optimum depth for motor performance. When setting the depth of the motor, be sure the top of the Lower Unit is submerged at least 12" below the surface of the water to avoid churning or agitation of surface water. It may be necessary to trim the motor up or down, depending on how the boat is responding. Trim up to avoid hitting underwater objects and trim down if the Prop is coming out of the water.

The Prop will temporarily stop while trimming the motor and resume once trimming is stopped. The motor is programmed to operate safely and limit Prop rotation when the Lower Unit is trimmed within certain limits. Trim limits are in place to avoid damage to the unit. A Lower Trim Limit is set approximately 3" from the bottom of the Control Head to the top of the Trim Housing. An Upper Trim Limit is set 13 1/2" from the bottom of the Mount to the center of the Lower Unit. A Prop Lockout Region, defined as 16" from the bottom of the Mount to the center of the Lower Unit, is used to eliminate the possibility of the motor contacting the boat hull. All functions, except for manual steering and recording an iTrack, are canceled upon trimming into this region.



## ▶ Trimming with the Wireless Remote

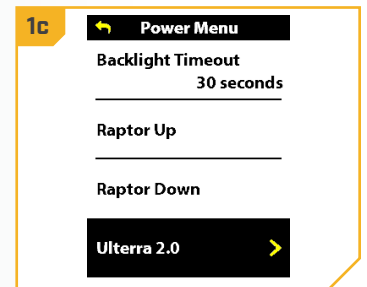
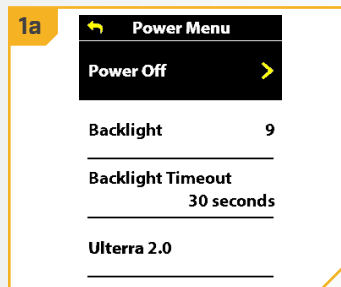

- 1 a. Press the Power  button on the Wireless Remote.
- b. Use the Speed Up  or Speed Down  button to find Ultrerra.
- c. Press the Steer Right  button to select Ultrerra and open Deployment Mode.

**NOTICE:** Alternatively, press the One-Boat Network  side button to quickly access Deployment Mode. The function of the OBN  side button is set by default to open the Ultrerra Deployment Mode menu.



# TRIMMING WITH THE WIRELESS REMOTE

2

- d. Once in Ulterra Menu, use the Speed Up  or Speed Down  button to select Trim Up or Trim Down. Trimming up will raise the motor and trimming down will lower the motor.
- e. Press and hold the Steer Right  button to select it.
- f. When the motor has reached its highest trim limit, the Prop will be locked out and the Trim Up option will be disabled. The Prop will stay locked out even when the Deployment Menu has closed. Trim the motor down and out of the Prop Lockout region to restore functionality.
- g. When the lower trim limit is reached, the Trim Down option will be disabled.

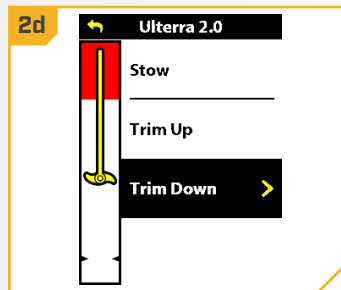
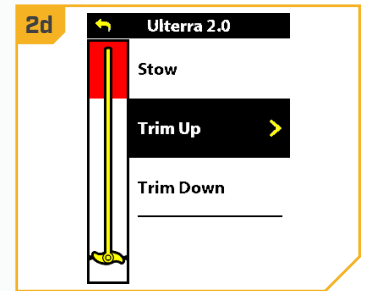
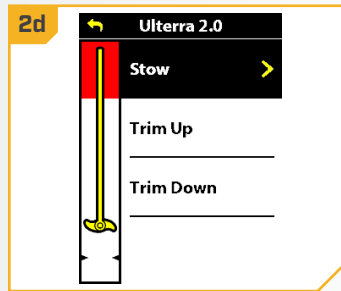

## WARNING

While Trim Up or Trim Down is pressed, the motor will automatically trim. Be sure the motor is clear from obstructions and has a clear path of travel. The Prop is disabled while the motor is being trimmed to prevent accidental contact with the rotating Prop.

## WARNING

When trimming the motor, keep fingers clear of all hinges, pivot points and all moving parts.

**NOTICE:** To avoid churning or agitation of surface water, ensure that the top of the motor is submerged at least 12" below the surface of the water.

**NOTICE:** The red area is the Prop Lockout region. The Prop will be automatically disabled if the lower unit is trimmed into this zone, and the Prop icon will turn gray. To restore Prop functionality, trim the lower unit out of the Prop Lockout region.



## ▶ Trimming with the OBN App

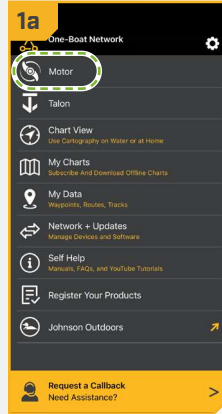

1

- a. Open the One-Boat Network (OBN) app on the mobile device. Make sure the mobile device is paired with the trolling motor.
- b. From the OBN home screen, tap the Motor menu. The Motor menu opens the Motor home screen.
- c. Before the Motor home screen will open, tap Agree on the on-screen prompt.



**NOTICE:** The on-screen prompt will only display once each time the app is launched. If the prompt has displayed, the Motor home screen appears after.

2

- d. Tap Trim/Stow on the bottom of the screen to open the Trim/Stow/Deploy menu.
- e. To trim the motor up, press and hold Trim Up . Continue to hold until the lower unit is at the desired height.
- f. To trim the motor down, press and hold Trim Down . Continue to hold until the lower unit is at the desired height.



### WARNING

While Trim Up or Trim Down is pressed, the motor will automatically trim. Be sure the motor is clear from obstructions and has a clear path of travel. The Prop is disabled while the motor is being trimmed to prevent accidental contact with the rotating Prop.

### WARNING

When trimming the motor, keep fingers clear of all hinges, pivot points and all moving parts.

**NOTICE:** To avoid churning or agitation of surface water, ensure that the top of the motor is submerged at least 12" below the surface of the water.

**NOTICE:** The red area is the Prop Lockout region. The Prop will be automatically disabled if the lower unit is trimmed into this zone, and the Prop icon will turn gray. To restore Prop functionality, trim the lower unit out of the Prop Lockout region.

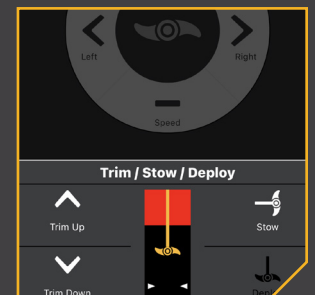

# TRIMMING WITH THE FOOT PEDAL

## Trimming with the Foot Pedal

1

- a. On the Foot Pedal, press the MODE button so that the white MODE MODE LED on the Indicator Panel is illuminated, putting the Foot Pedal in Deployment Mode.

**NOTICE:** The motor can only trim while in Deployment Mode.

### **WARNING**

When trimming the motor, keep fingers clear of all hinges, pivot points, and all moving parts.

### **WARNING**

While Trim Up or Trim Down is pressed, the motor will automatically trim. Be sure the motor is clear from obstructions and has a clear path of travel. The Prop is disabled while the motor is being trimmed to prevent accidental contact with the rotating Prop.

- b. To trim the motor up, press the Trim Up button located on the bottom left of the Foot Pedal.
- c. To trim the motor down, press the Trim Down button located on the bottom right of the Foot Pedal.



**NOTICE:** To avoid churning or agitation of surface water, ensure that the top of the motor is submerged at least 12" below the surface of the water.

This completes the installation of the Ulterra QUEST. A complete Owner's Manual can be downloaded at [minnkota.johnsonoutdoors.com](http://minnkota.johnsonoutdoors.com).

# NOTES



A large area containing multiple horizontal lines for writing notes.

# RECOMMENDED ACCESSORIES

## › ON-BOARD & PORTABLE BATTERY CHARGERS

Stop buying new batteries and start taking care of the ones you've got. Many chargers can actually damage your battery over time – creating shorter run times and shorter overall life. Digitally controlled Minn Kota chargers are designed to provide the fastest charge that protect and extend battery life.



MK212PCL



MK210D



MK110PD

## › TALON SHALLOW WATER ANCHOR

Talon is the only shallow water anchor with up to 15' of anchoring depth, multiple anchoring modes, and control from the bow, transom, console, remote or mobile device.



### BUILT-IN WORK LIGHT

Lets you tie lines and work from the transom any time of day — or night. Includes both white and blue LED lights with three brightness settings.



### BLUETOOTH® CONNECTIVITY

Lets you control Talon from your mobile device and easily update it. Also opens up communication to other control options.



### UP TO 15' DEEP

Control more water and catch more fish with the first 15' shallow water anchor.



### MORE CONTROL OPTIONS

- Control Panel
- Wireless Remote
- Mobile App
- Wireless Foot Switch
- Humminbird® Connectivity
- Advanced GPS Navigation System Remote



## › MINN KOTA ACCESSORIES

We offer a wide variety of trolling motor accessories, including:

- 60-Amp Circuit Breaker
- Mounting Brackets
- Stabilizer Kits
- Boat Deck Reinforcement Kit
- Battery Connectors
- Battery Boxes
- Quick Connect Plugs



minnkota.johnsonoutdoors.com    

Part #2207125

Minn Kota Consumer & Technical Service  
Johnson Outdoors Marine Electronics, Inc.  
PO Box 8129  
Mankato, MN 56001

121 Power Drive  
Mankato, MN 56001  
Phone (800) 227-6433  
Fax (800) 527-4464



©2023 Johnson Outdoors Marine Electronics, Inc.  
All rights reserved.

ECN 44313

Rev B

10/23