

Polyform

U.S.[®]

True Fit Fender Holder System

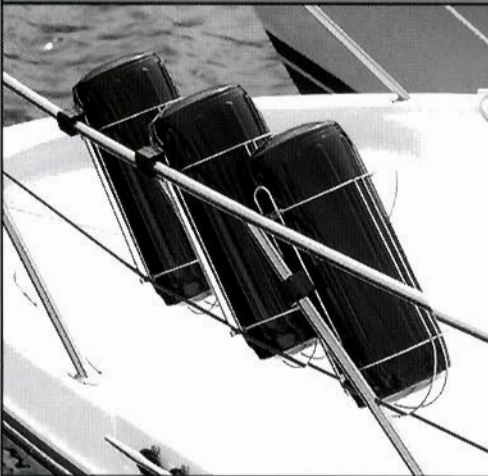

This True Fit Holder System Contains:

3 Fender Holder Baskets

4 TFR-402 Swivel Connectors

2 Pair TFR-403 Parallel Connectors

Polyform U.S. 7030 South 224th Street, Kent, WA 98032 1-800-423-0664



True Fit Fender Holder System

Assembling your fender holders is an easy process. Make sure you have all required components before beginning. Leave all screws loose until your unit is fully assembled and positioned as desired, then tighten securely.

1 Check that you have all needed components.

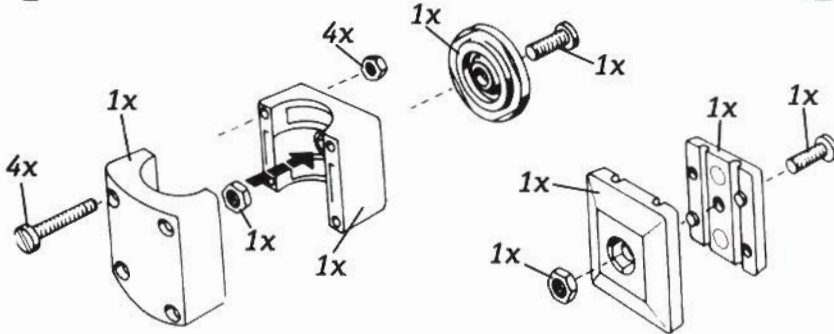

2 Preassemble and secure all nuts with a piece of tape to prevent them from falling into the water

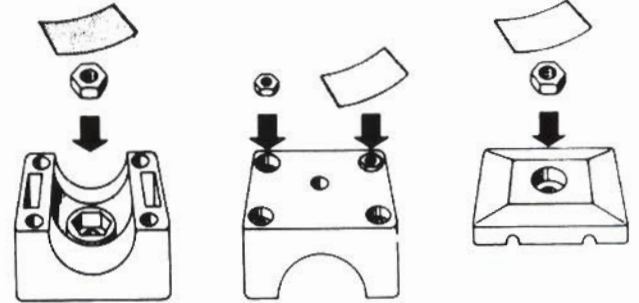

3 1) Loosen the console from the basket.
2) Turn it 180° and assemble it on the basket
3) *The screw shall be assembled from the inside*

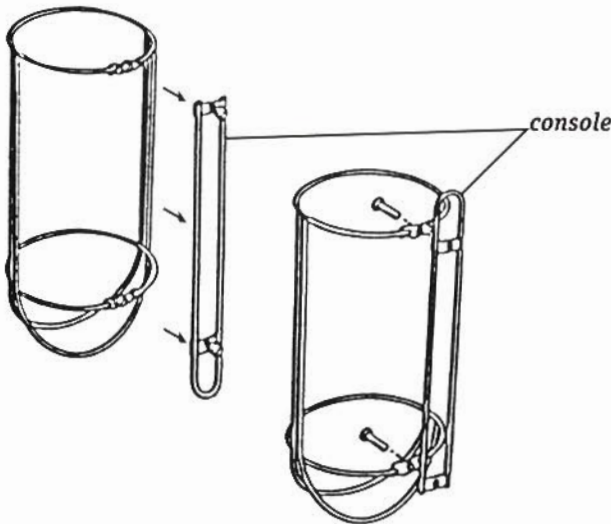

4 Assemble the parallel connector. *Don't tighten the screws.*

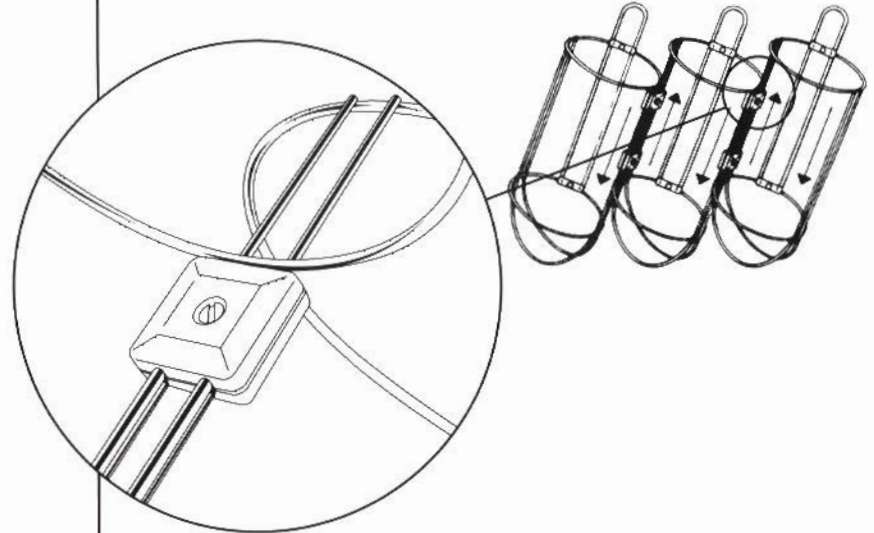

5 Assemble the swivel connectors on your rail or stanchion. *Don't tighten the screws.*



6 Mount the basket-unit on to the preassembled swivel connectors and align the installation to your rail.

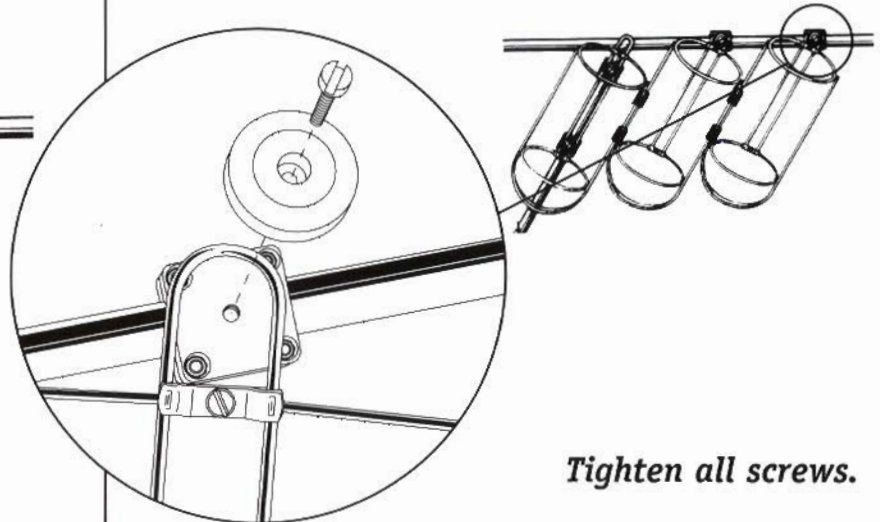

Tighten all screws.