



SingleViu™

User Manual

for *SingleViu* gauges

**Please keep this manual for future reference.
Read manual before attending any work.**



Dear customer,

Congratulation on purchasing a gauge of the *SingleViu* family.

This user manual applies to *SingleViu*, a family of single gauges of the Continental company. It addresses technicians and users and contains relevant information that may be necessary for correct usage of the gauge.

Please keep this manual carefully for future reference.



This operating manual contains important instructions for safe and correct assembly and usage of the SingleViu gauges. Carefully read all relevant chapters before you start any work with the gauge. Pictures and illustrations within this user manual show examples of gauges. The gauge at hand may vary, e.g. in diameter or dial design.

For further information and additional technical documentation for this product please contact your local specialist dealer. Also visit us on our web page.

Sincerely, Continental

Continental Automotive GmbH
 Sodener Strasse 9
 65824 Schwalbach
 Germany

singleviu@continental-corporation.com
www.continental-singleviu.com

VDO – A trademark of the Continental Corporation

The reproduction, distribution and utilization of this document as well as the communication of its contents to others without express authorization is prohibited. Offenders will be held liable for the payment of damages. All right reserved in the event of the grant of a patent, utility model or design.

We reserve the right to make changes in availability as well as technical changes without prior notice.

Table of contents

1. General	4
1.1 Symbols in this manual	4
1.2 Definitions and Abbreviations	4
1.3 Homologation	5
2. Safety instructions	6
2.1 ... regarding users	6
2.2 ... regarding intended use	6
2.3 ... before installation	6
2.4 ... regarding mounting position	6
2.5 ... during electrical installation	7
2.6 ... after installation	7
3. Technical data	8
3.1 Dimensions	8
3.2 Environmental and electrical durability	8
3.3 Electrical connection	8
3.4 Pin description	9
4. Composition and Functions	12
4.1 Pointer	13
4.2 Tell-tales	13
4.3 Display and push-button	14
4.4 Illumination	14
4.5 Send indication value onto CAN	14
4.6 External Buzzer	14
5. Variants overview	15
5.1 Variants 52 mm	15
5.2 Variants 80 mm	20
5.3 Variants 100 mm	20
5.4 Package content	20
6. Handling and Mounting instruction	21
6.1 Transportation and storage	21
6.2 Disconnect the power supply	21
6.3 Prepare the mounting space	21
6.4 Mounting of the connector	23
6.5 Mounting the gauge	24
6.6 Reconnect the power supply	24
7. Configuration and initial setup	25
7.1 Configuration via <i>SingleViu ConfigTool</i>	25
7.2 Configuration via push-button	29
8. Operating menu	31
8.1 Operating menu for gauge with diameter 52 mm	31
8.2 Operating menu for speedometers	31
8.3 Operating menu for tachometers	32
9. Replacement of gauges of predecessor series	33
9.1 Replacement of Viewline	33
9.2 Replacement of World Wide Gauges	34
9.3 Replacement of CANcockpit	36
10. Maintenance	37
11. Shutdown and Disposal	37
11.1 Disconnect the power supply	37
11.2 Dismantling	37
11.3 Reconnect the power supply	38
11.4 Decommissioning and disposal	38
12. Accessories and spare parts	39
12.1 Spare parts	39
12.2 Adapter cables	39
12.3 <i>SingleViu ConfigTool</i> , Programming dongle and CAN Boxen	39
12.4 MOLEX connector and crimp contacts	39

1. General

1.1 Symbols in this manual

Read the relevant parts of the manual completely and carefully before attending the work on the gauge. Nonobservance of the safety instructions may lead to injuries or damages. For questions or obscurities approach to your ► specialized dealer.

Symbols in this manual are used as follows:

» Instructions are marked with this double arrow.

► An arrow marks a keyword, that is defined in a separate chapter. You can find the full list of all keywords in the glossary, chapter definitions 1.2.



This symbol warns of dangers for your health and possible injuries.



This symbol indicates possible damages of the product or other property.

REMARK:

Additional information on the product or current action.

1.2 Definitions and Abbreviations

Accessories	Usable articles except gauge and mounting nut. (chapter 12)
CAN bus SAE J1939	Vehicle bus system with network protocol SAE J1939.
ConfigTool	Receive <i>SingleViu ConfigTool</i> via ► specialist dealer. (chapter 7.1)
Configuration, Configuration menu	The gauges can be configured via <i>ConfigTool</i> (chapter 7.1) or via Push-button in the configuration menu. (chapter 7.2)
Connector	Connector of cable harness to <i>SingleViu</i> gauge. (chapter 12.5 and chapter 6.3)
Contact cable	Pre-assembled cable to connect a gauge. (chapter 12.2)
Declaration of conformity	CE mark for conformity with EU regulations (chapter 1.3.1). Receive the certificate via ► specialized dealer.
Dongle	USB-stick containing license to change locked parameters. (chapter 7.1 and chapter 12.4)
Homologation	UN-ECE R10 (chapter 1.3.2). Receive the certificate via ► specialized dealer.
IMDS	International material database of automotive industry that contains all parts of <i>SingleViu</i> gauges. Excerpt available via ► specialized dealer.
Operationmenu	Menu that contains different information in driving mode. (chapter 8)
Push-button	Internal or external push-button. (chapter 4.3)
RGB	Color space with the three primary colors red, green and blue.
Sensor curve	Preset and adjustable sensor curve for analog sensor data. (chapter 5.1)
Specialized dealer	Partner company of Continental and regional distributor of <i>SingleViu</i> . A list of specialized dealers is available in the partner finder on our website www.continental-singleviu.com
Tell-tales	Integrated tell-tales in the gauge. (chapter 4.2)
UBat	Battery voltage and actual supply voltage U _{DC} .
U _{DC}	Direct current voltage.
Variants overview	List of all <i>SingleViu</i> variants. (chapter 5)
Warning thresholds	Thresholds to activate tell-tale 1 (chapter 4.2)

1.3 Homologation

1.3.1 CE mark

All gauges of the *SingleViu* family have been developed and produced in compliance to EU regulation 765/2008 and therefore show the “CE” mark on their label.
The official ► declaration of conformity is available.



1.3.2 Homologation according to UN-ECE

The gauge of the *SingleViu* family have been tested according to regulation UN-ECE 10R („electromagnetic compatibility“) and the type has been homologated.
The gauges therefore show the “E” mark on their label.
The official ► Homologation is available.



2. Safety instructions

2.1 ... regarding users

- This manual addresses technicians and users.
- Technicians are appropriately trained or experienced persons with basic knowledge of the vehicle / shipbuilding electrical system and mechanics. Installation, configuration and commissioning of the product must be carried out by a technician to prevent personal injury, property damage or environmental damage.
- Users are in particular drivers and other personnel of the target vehicle who operate and clean the gauges. Users must be instructed in the function of the gauge before use.

2.2 ... regarding intended use

- The gauge is designed for use in ground vehicles and machines as well as in pleasure boats, either for commercial or private use.
- The gauge is designed for nominal voltages of 12 or 24 V_{DC}. If the nominal voltage is exceeded, the gauge may be damaged.
- The gauge may only be used to display specific vehicle or machine parameters.
- Changes or manipulations may have an impact on safety. Changed, manipulated or damaged gauges must not be used.

2.3 ... before installation

- Wear appropriate work clothing. Do not wear loose clothing, as it may get caught in moving parts. Protect long hair with a hair net.
- Ensure appropriate surrounding conditions. Before working underneath the vehicle, secure it thoroughly.
- Make sure that the engine cannot start unintentionally during installation.
- When removing/installing seats, covers, etc., ensure that lines are not damaged and plug-in connections are not loosened.
- Note all data from other installed gauges with volatile electronic memories.

2.4 ... regarding mounting position

- Consider the needed clearance behind the gauge and its mounting hole diameter.
- The gauge must not impair the driver's field of vision.
- Do not install the gauge in the mechanical and electrical airbag area.
- Do not drill holes or ports in load-bearing or stabilizing stays or tie bars.
- If installing the gauge near a magnetic compass, note the magnetic safe distance to the compass. Recommendation: Minimum 30 cm.
- Pay attention to how lines and cable harnesses are laid so that you do not damage them.
- Drill small ports; enlarge and complete them, if necessary, using taper milling tools, saber saws, keyhole saws or files. Deburr edges.

2.5 ... during electrical installation

- Before beginning, remove voltage supplies. Disconnect the negative terminal on the battery and auxiliary batteries.
- Faulty connections can cause short circuits. Only connect cable according to specified pin assignment.
- Only use fused voltage supply. Recommendation: 5 Amp fuse.
- Use cables with sufficient cross-sectional area and insulation. Reducing the cable cross-sectional area leads to higher current density which can cause the cable cross-sectional area in question to heat up.
- When installing electrical cables, use the existant cable ducts and harnesses; however, do not run cables parallel to ignition cables or to cables that lead to large electricity consumers.
- Fasten cables with cable ties or adhesive tape. Do not run cables over moving parts. Do not attach cables to the steering column. Ensure that cables are not subject to tensile forces.
- If cables are run through drill holes, protect them using rubber sleeves or the like.
- Use only a cable stripper to strip the cable and adjust it so that stranded wires are not damaged or separated.
- Use only a soft soldering process or commercially available crimp connector to create new cable connections.
- Make crimp connections with cable crimping pliers only.
- Insulate exposed stranded wires to prevent short circuits.

2.6 ... after installation

- Do not operate vehicle/machine with faulty connections or damaged cables.
- Reconnect the ground cable tightly to the negative terminal of the battery and auxiliary batteries.
- Reenter/reprogram the volatile electronic memory values.
- Check all functions of vehicle/machine.

SingleViu™

3. Technical data

3.1 Dimensions

Mounting hole diameter	52 - 53 mm	80 - 81 or 85 - 86 mm	100 - 101 mm
Device diameter	52 mm	80 mm	100 mm
Device depth	76 mm	80 mm	80 mm
Mounting depth incl. connector	110 mm	110 mm	110 mm
Weight	78 g	100 g	120 g

3.2 Environmental and electrical durability

Operating temperature range	-40 °C to +80 °C (-40 °F to +176 °F) Display: -20 °C to +80 °C (-4 °F to +176 °F)	
Storage temperature range	-40 °C to +85 °C (-40 °F to +185 °F)	
Level of protection	IP 67 (without connector IP 40)	
Chemical durability	- ammonia based cleaner - methylated spirits - interior cleaner - drinks containing caffeine and tannin (coffee, tea and cola)	
Mechanical shocks	Continuous Single Free fall	25 g; 6 ms 100 g; 11 ms 1 m
Vibration	Periodic Stochastic	2 g; 8 - 500 Hz 4.2 g; 10 - 1000 Hz
Temperature shock	Range Transformation time Retention time	-40 °C to +85 °C 10 seconds 2 h
Climatic storage	Range Rel. humidity	+25 °C to +55 °C 80% to 100%
Salt spray test	5% NaCl, 672 h	
EMC	Radiated Emission Immunity Bulk current injection	CISPR25 class 3 IEC 61000-6-2 class A ISO11452-4 class A
Inverse-polarity protection	yes	

3.3 Electrical connection

Nominal voltage	12 V _{DC} or 24 V _{DC}
Operation voltage range	8 V _{DC} to 32.5 V _{DC}
Current consumption	< 200 mA at nominal voltage
Quiescent current	< 3 mA

3.4 Pin description

3.4.1 8-pin connector

Every *SingleViu* gauge contains a contact for a ► connector MOLEX 334724801 with 8 pins.

Pin	Description	Remark	Cable color ► contact cable
1	Terminal 30	Battery Plus (12/24 V _{DC})	red
2	Terminal 31	Battery Minus (Ground)	black
3	Sensor ground	Ground reference for sensor signal	blue
4	Terminal 15	Ignition	brown
5	Sensor input	Contact for analog sensor signal	green
6	Terminal 58	Illumination	blue/red
7	CAN High	Input for CAN bus SAE J1939	white
8	CAN Low	Input for CAN bus SAE J1939	pink

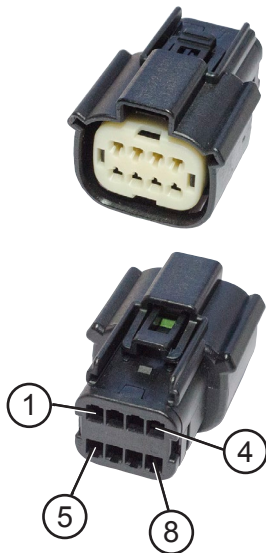

Fig. 3.1: Molex 8-pin connector

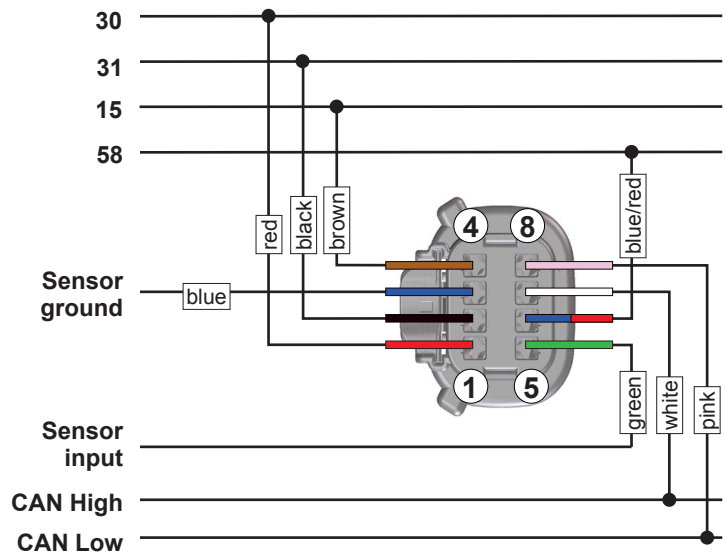

Fig. 3.2: Wiring diagram 8-pin connector

Pin 1: Power Supply (Terminal 30)

$U_{Bat} = +8 V_{DC}$ to $+32.5 V_{DC}$

The gauge is supplied with permanent power through this terminal. Current consumption is less than 200 mA in operation mode at 12 V_{DC} and less than 3 mA quiescent current. After an over- or undervoltage event, restart will be debounced by 0.5 V.

Pin 2: Ground (Terminal 31)

Ground connection for the gauge's power supply.

Pin 3: Sensor ground

Ground reference for the analog sensor input, see pin 5.

Pin 4: Ignition (Terminal 15)

Range: 0 V to U_{Bat} . Switch on at $>4 V_{DC}$, switch off at $<2.5 V_{DC}$, debouncing time of 200 ms. Wake over CAN is also possible.

Pin 5: Sensor input

Sensor input depends on gauge variant with its analog input.

- a) Resistive input
Range: 0 to 500 Ohm
- b) Voltage input
Range: 0 to 6 V or -100 to +100 mV
- c) Frequency input
 $U_{low} < 0.2 V, U_{high} > = 1 V$. Frequencies up to 400 kHz are possible.

The predefined ► sensor curve depends on gauge variant.

Pin 6: Illumination (Terminal 58)

Range: 0 V to U_{Bat} . Switch on at $>4 V_{DC}$, switch off at $<2.5 V_{DC}$, debouncing time of 200 ms.

Pin 7: CAN High

Contact pin for CAN High according to ISO 11898 without termination resistance. *SingleViu* is capable for use with ► CAN bus SAE J1939.

Pin 8: CAN Low

Contact pin for CAN Low according to ISO 11898 without termination resistance. *SingleViu* is capable for use with ► CAN bus SAE J1939.

3.4.2 12-pin connector

SingleViu gauges with diameter of 80 and 100 mm contain an additional contact for a ► connector MOLEX 334721201 with 12 pins.

Pin	Description	Remark	Cable color ► contact cable
1	CAN High	Opt. input for CAN bus SAE J1939	white
2	CAN Low	Opt. Input for CAN bus SAE J1939	pink
3	Termination resistance 1	CAN termination resistance 120 Ohm	red
4	Termination resistance 2	CAN termination resistance 120 Ohm	
5	Digital input 1	Control of tell-tale 1	yellow/white
6	Digital input 2	Control of tell-tale 2	yellow/blue
7	Digital input 3	Control of tell-tale 3	yellow/red
8	Digital input 4	Control of tell-tale 4	yellow/green
9	Digital input 5	Control of tell-tale 5	yellow/black
10	Digital input 6	Connection for external push-button	grey/pink
11	Digital output 1	Connection for external buzzer	grey
12	Digital input 7	Configuration pin	orange

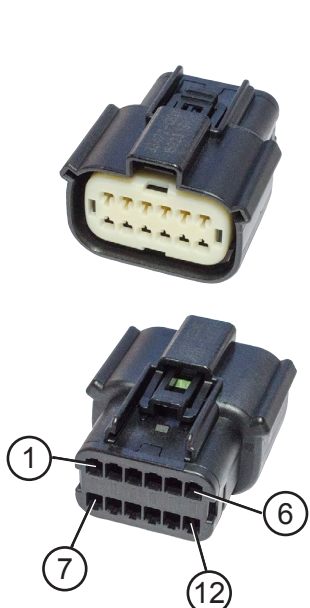

Fig. 3.3: Molex 12-pin connector

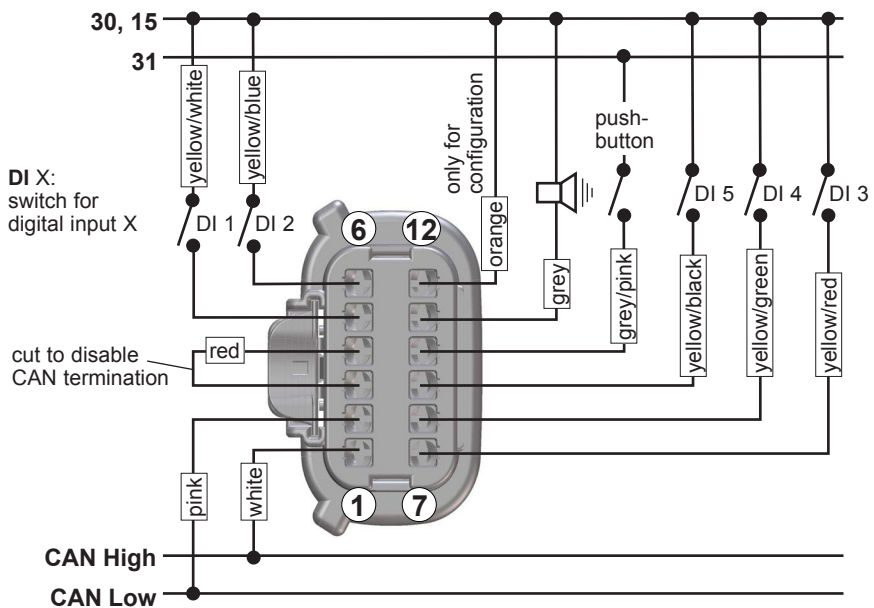

Fig. 3.4: Wiring diagram 12-pin connector

TU00-0761-5207102

Pin 1: CAN High

Optional contact pin for CAN High according to ISO 11898 without termination resistance. It can also be used for loop-through of the CAN bus.

Pin 2: CAN Low

Optional contact pin for CAN Low according to ISO 11898 without termination resistance. It can also be used for loop-through of the CAN bus.

Pin 3: Termination resistance 1

Optional termination resistance pin according to ISO 11898. Connect pins 3 and 4 to activate the termination resistance.

Pin 4: Termination resistance 2

Optional termination resistance pin according to ISO 11898. Connect pins 3 and 4 to activate the termination resistance.

Pin 5: Digital input 1

Range: 0 V to U_{Bat} . Switch on at $>4 V_{DC}$, switch off at $<2.5 V_{DC}$, debouncing time of 200 ms. Control option for ► tell-tale 1 which is the hazard lamp. Input is set to high-active by default.

Pin 6: Digital input 2

Range: 0 V to U_{Bat} . Switch on at $>4 V_{DC}$, switch off at $<2.5 V_{DC}$, debouncing time of 200 ms. Control option for ► tell-tale 2 which is the malfunction indicator lamp. Input is set to high-active by default.

Pin 7: Digital input 3

Range: 0 V to U_{Bat} . Switch on at $>4 V_{DC}$, switch off at $<2.5 V_{DC}$, debouncing time of 200 ms. Control option for ► tell-tale 3 which is the red stop lamp. Input is set to high-active by default.

Pin 8: Digital input 4

Range: 0 V to U_{Bat} . Switch on at $>4 V_{DC}$, switch off at $<2.5 V_{DC}$, debouncing time of 200 ms. Control option for ► tell-tale 4 which is unused by default. Input is set to high-active by default.

Pin 9: Digital input 5

Range: 0 V to U_{Bat} . Switch on at $>4 V_{DC}$, switch off at $<2.5 V_{DC}$, debouncing time of 200 ms. Control option for ► tell-tale 5 which is unused by default. Input is set to high-active by default.

Pin 10: Digital input 6

Connection pin for an optional external switch, e.g. push-button. The pin is low-active which requires the switch to be connected between ground and this pin.

Pin 11: Digital output 1

Connection pin for an optional external device, e.g. buzzer or additional warning lamp. The output is an open drain and acts like a low switch to ground.

Maximum voltage: $5 V_{DC}$

Maximum current: 500 mA

Pin 12: Digital input 7

Range: 0 V to U_{Bat} . Switch on at $>4 V_{DC}$, switch off at $<2.5 V_{DC}$, debouncing time of 200 ms. This configuration pin can be used to enter the extended ► configuration menu.

4. Composition and Functions

Figure 4.1 shows the composition of an 80mm gauge. Gauges with diameter 52mm have the same structure without having a push-button and display.

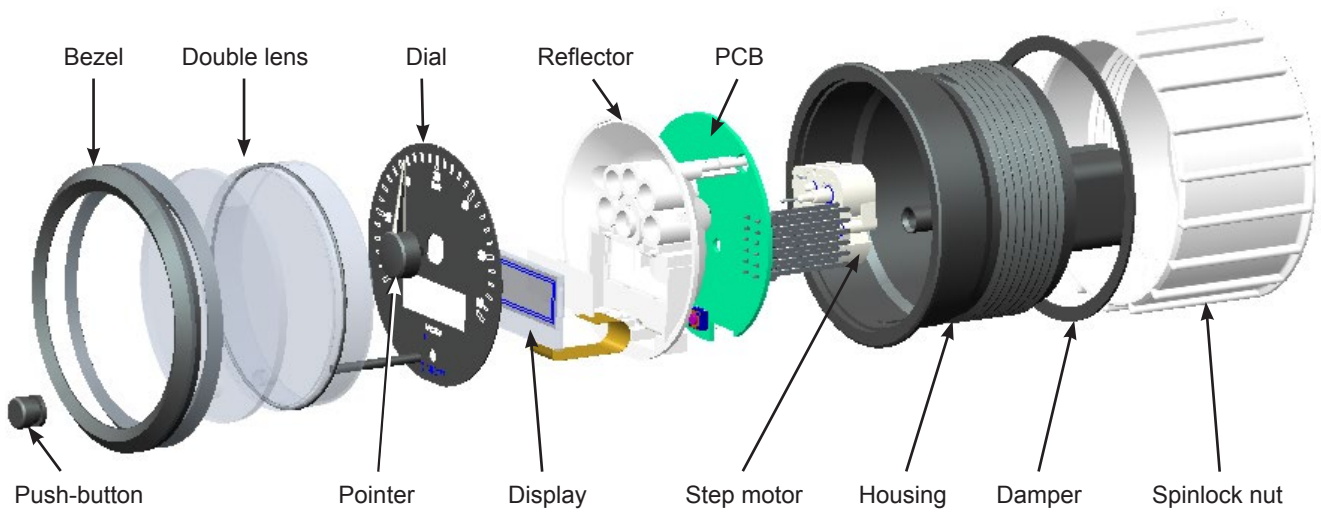

Fig. 4.1: Composition of a SingleViu gauge.

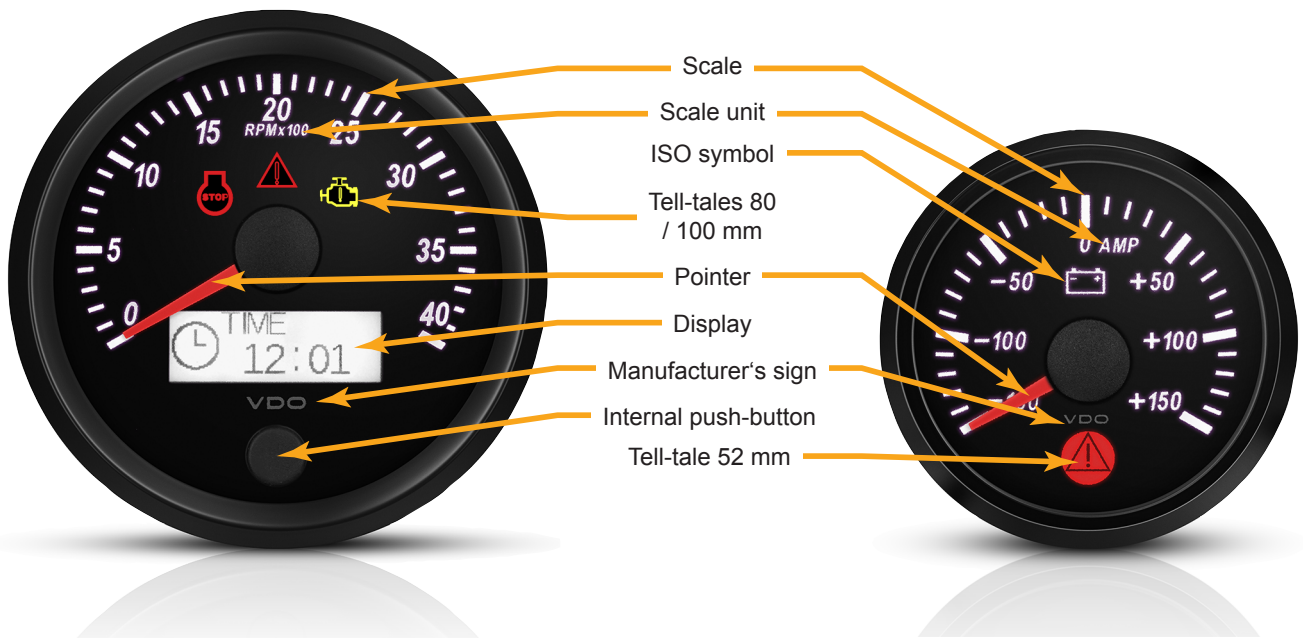

Fig. 4.2: Dial elements 80 and 100 mm

Fig 4.3: Dial elements 52 mm

TU00-0761-5207102

4.1 Pointer

Main function of the gauge is to visualize a parameter which is sent via analog signal or CAN bus.

Pointer indication angle	240°
Pointer tolerance	-3° to +3°, Speedometer 0° to 6°

4.2 Tell-tales

4.2.1 Tell-tale in gauges with diameter 52 mm

Gauges with diameter 52 mm contain a tell-tale, symbol 0434A acc. to ISO 7000 with red illumination.

Per default, the tell-tale will be activated for indication values beyond the scale limits. For level gauges, the lower warning threshold is at a level of 10% and for the tachometer A2C38330300 at a rotational speed of 400 RPM.

All other warning thresholds are set to the scale limits by default.

Changes of the thresholds are possible using the ► *ConfigTool*.

4.2.2 Tell-tales in gauges with diameter 80 or 100 mm

SingleViu gauges with diameter 80 or 100 mm can be equipped with up to 5 tell-tales. Their positions on the dial are shown in following picture.



Fig. 4.4: Layout of the tell-tales in gauges with 80 mm and 100 mm diameter.

Tell-tale 1 shows a warning triangle, symbol 0434A according to ISO 7000, with red illumination. This tell-tale can be activated by indication values beyond the scale limits.

For tachometers, the lower activation threshold is 400 RPM.

All other warning thresholds are set to the scale limits by default.

Changes of the thresholds are possible using the ► *ConfigTool* and by setting them in the extended ► configuration menu.

Tell-tale 2 shows a cylinder symbol with text "STOP", symbol 1388 according to ISO 7000, with red illumination. This tell-tales serves as red stop lamp according to SAE J1939-73. It can be activated by lamp status in CAN message DM1, SPN 1213, PGN 65226.

Per default, Tell-tale 2 is equipped in tachometers.

Tell-tale 3 shows a motor symbol, symbol 2423 according to ISO 7000, with yellow illumination. This tell-tale serves as malfunction indicator lamp according to SAE J1939-73. It can be activated by pin 6 of the 12-pin connector or by lamp status in CAN message DM1, SPN 1213, PGN 65226.

Per default, tell-tale 3 is equipped in tachometers.

Tell-tales 4 and 5 are not equipped in platform gauge variants.

4.3 Display and push-button

SingleViu gauges with diameter 80 or 100 mm contain an internal display on which diverse information may be shown. This information is organized in ► configuration menu and ► operation menu.

SingleViu gauges with diameter 80 or 100 mm contain an internal push-button to operate the display. An external push-button, which has to be connected to pin 10 of the 12-pin connector, has the same functionality.

4.3.1 Welcome logo

The welcome logo is a static picture that will be shown after every ignition for an adjustable time. Setting of the functionality is possible in ► ConfigTool.

4.4 Illumination

All gauges of the SingleViu family can alter the brightness and color of their background illumination for dial and display if available. This can be done by CAN message PGN 53503 / SPN 1487, by ► ConfigTool, or for devices with diameter 80 or 100 mm, also using the ► push-button.

In case of illumination setting by push-button, the device will try to broadcast a CAN message with PGN 53503. Byte 1 contains SPN1487 for illumination brightness. Additionally, bytes 4 – 8 will be used for privately communicating the illumination color to all other SingleViu gauges which are connected to the CAN bus.

Illumination of the pointer of the dial of the display	red RGB, default white RGB, default white
--	---

4.5 Send indication value onto CAN

All gauges of the SingleViu family are able to broadcast the indication value as CAN message. They will use their predefined source address as in ► variants overview and the default value for priority, SPN and PGN. All bytes other than the SPN in the CAN message will be written as 0xFF.

This function is not available for the air pressure gauge and the cylinder temperature gauges.

4.6 External Buzzer

The digital output, pin 11 of the 12 pin connector, is linked to all ► tell-tales to attach an external buzzer or another electric device. The predefined signal consists of 100 ms „ON“ and 400 ms „OFF“.

SingleViu™

5. Variants overview

5.1 Variants 52 mm

Article number		Gauge type		Scale			Analog input			CAN input				
Single packaging	OEM packaging (25 pieces)	Gauge type	Reference	Scale symbol	Min	Max	Unit	Type	Signal range	Sensor curve	PGN	SPN	CAN Source address	
A2C3833090001	A2C3833090025	Ammeter		ISO 0247		-30	+30	AMP	Voltage	-60 - +60 mV	5.1.1	65271	114	0x29
A2C3833080001	A2C3833080025	Ammeter		ISO 0247		-60	+60	AMP	Voltage	-60 - +60 mV	5.1.2	65271	114	0x29
A2C3833070001	A2C3833070025	Ammeter		ISO 0247		-100	+100	AMP	Voltage	-60 - +60 mV	5.1.3	65271	114	0x29
A2C3833060001	A2C3833060025	Ammeter		ISO 0247		-150	+150	AMP	Voltage	-60 - +60 mV	5.1.4	65271	114	0x29
A2C3832760001	A2C3832760025	Concentration	DEF/AdBlue®	ISO 2946 + "DEF"		0	100	%		n.a.		64923	3516	0x27
A2C3833550001	A2C3833550025	Level	DEF/AdBlue®	ISO 0245 + "DEF"		0	1		Resistance	3 - 180 Ω	5.1.5	65110	1761	0x27
A2C3832750001	A2C3832750025	Level	DEF/AdBlue®	ISO 0245 + "DEF"		E	F		Resistance	240 - 33.5 Ω	5.1.6	65110	1761	0x27
A2C3833100001	A2C3833100025	Level	Fuel	ISO 0245		0	1		Resistance	3 - 180 Ω	5.1.5	65276	96	0x27
A2C3833110001	A2C3833110025	Level	Fuel	ISO 0245		0	1		Resistance	90 - 5 Ω	5.1.7	65276	96	0x27
A2C3833120001	A2C3833120025	Level	Fuel	ISO 0245		E	F		Resistance	3 - 180 Ω	5.1.5	65276	96	0x27
A2C3833130001	A2C3833130025	Level	Fuel	ISO 0245		E	F		Resistance	240 - 33.5 Ω	5.1.6	65276	96	0x27
A2C3833140001	A2C3833140025	Level	Fuel	ISO 0245		E	F		Resistance	0 - 90 Ω	5.1.8	65276	96	0x27
A2C3833150001	A2C3833150025	Level	Fuel	ISO 0245		E	F		Resistance	90 - 5 Ω	5.1.7	65276	96	0x27
A2C3916300001	A2C3916300025	Level	Fuel	ISO 0245		E	F		Voltage	0 - 5 V	5.1.9	65276	96	0x27
A2C3833440001	A2C3833440025	Pressure	Air	"AIR"		0	150	psi	Resistance	10 - 184 Ω	5.1.10	n.a.		
A2C3833450001	A2C3833450025	Pressure	Brake	ISO 1402		0	10	bar	Resistance	10 - 184 Ω	5.1.11	65274	117	0x25
A2C3832710001	A2C3832710025	Pressure	Brake	ISO 1402		0	16	bar	Voltage	0.5 - 4.5 V	5.1.12	65274	117	0x25
A2C3833480001	A2C3833480025	Pressure	Brake	ISO 1402		0	150	psi	Resistance	10 - 184 Ω	5.1.10	65274	117	0x25
A2C3832730001	A2C3832730025	Pressure	Brake	ISO 1402		0	250	psi	Voltage	0.5 - 4.5 V	5.1.13	65274	117	0x25
A2C1800310001	A2C1800310025	Pressure	Brake	ISO 1405		0	10	bar	Voltage	0 - 5 V	5.1.35	65274	117	0x25
A2C1800330001	A2C1800330025	Pressure	Brake	ISO 1406		0	10	bar	Voltage	0 - 5 V	5.1.35	65274	117	0x25
A2C1800340001	A2C1800340025	Pressure	Brake	ISO 0238		0	10	bar	Voltage	0 - 5 V	5.1.35	65274	117	0x25
A2C3833460001	A2C3833460025	Pressure	Gear oil	ISO 1167		0	25	bar	Resistance	10 - 184 Ω	5.1.14	65272	127	0x23
A2C3832720001	A2C3832720025	Pressure	Gear oil	ISO 1167		0	30	bar	Voltage	0.5 - 4.5 V	5.1.15	65272	127	0x23
A2C3833500001	A2C3833500025	Pressure	Gear oil	ISO 1167		0	400	psi	Resistance	10 - 184 Ω	5.1.16	65272	127	0x23

SingleViu™

Article number		Gauge type		Scale			Analog input			CAN input			
Single packaging	OEM packaging (25 pieces)	Gauge type	Reference	Scale symbol	Min	Max	Unit	Type	Signal range	Sensor curve	PGN	SPN	CAN Source address
A2C3832740001	A2C3832740025	Pressure	Gear oil	ISO 1167	0	500	psi	Voltage	0.5 - 4.5 V	5.1.17	65272	127	0x23
A2C3833160001	A2C3833160025	Pressure	Engine oil	ISO 0248	0	5	bar	Resistance	10 - 184 Ω	5.1.20	65263	100	0x22
A2C3833170001	A2C3833170025	Pressure	Engine oil	ISO 0248	0	10	bar	Resistance	10 - 184 Ω	5.1.11	65263	100	0x22
A2C3833230001	A2C3833230025	Pressure	Engine oil	ISO 0248	0	80	psi	Resistance	240 - 33.5 Ω	5.1.21	65263	100	0x22
A2C3833190001	A2C3833190025	Pressure	Engine oil	ISO 0248	0	80	psi	Resistance	10 - 184 Ω	5.1.22	65263	100	0x22
A2C3832690001	A2C3832690025	Pressure	Engine oil	ISO 0248	0	10	bar	Voltage	0.5 - 4.5 V	5.1.18	65263	100	0x22
A2C3833240001	A2C3833240025	Pressure	Engine oil	"OIL"	0	150	psi	Resistance	10 - 184 Ω	5.1.10	65263	100	0x22
A2C3833300001	A2C3833300025	Pressure	Engine oil	ISO 0248	0	150	psi	Resistance	10 - 184 Ω	5.1.10	65263	100	0x22
A2C3832700001	A2C3832700025	Pressure	Engine oil	ISO 0248	0	150	psi	Voltage	0.5 - 4.5 V	5.1.19	65263	100	0x22
A2C3833490001	A2C3833490025	Pressure	Turbo	ISO 2107	0	2	bar	Resistance	10 - 184 Ω	5.1.23	65270	102	0x24
A2C3833470001	A2C3833470025	Pressure	Turbo	ISO 2107	0	60	psi	Resistance	10 - 184 Ω	5.1.24	65270	102	0x24
A2C3833050001	A2C3833050025	Pyrometer		ISO 1383 + "PYRO"	0	1000	°C	Voltage	4.1 - 37.7 mV	5.1.25	65270	173	0x30
A2C3833040001	A2C3833040025	Pyrometer		ISO 1383 + "PYRO"	0	2000	°F	Voltage	4.1 - 37.7 mV	5.1.26	65270	173	0x30
A2C3833030001	A2C3833030025	Tachometer			0	40	RPM x 100		n.a.		61444	190	0x17
A2C3833520001	A2C3833520025	Temperature	Cylinder		60	200	°C	Resistance	482.5 - 14.3 Ω	5.1.27			n.a.
A2C3833530001	A2C3833530025	Temperature	Cylinder		150	400	°F	Resistance	482.5 - 14.3 Ω	5.1.28			n.a.
A2C3833510001	A2C3833510025	Temperature	Hydraulic oil	ISO 1414	40	120	°C	Resistance	287.4 - 22.7 Ω	5.1.29	65128	1638	0x21
A2C3916310001	A2C3916310025	Temperature	Hydraulic oil	ISO 1414	0	250	°F	Resistance	287.4 - 22.7 Ω	5.1.30	65128	1638	0x21
A2C3833380001	A2C3833380025	Temperature	Engine oil	ISO 2426	50	150	°C	Resistance	322.8 - 18.6 Ω	5.1.31	65262	175	0x19
A2C3833390001	A2C3833390025	Temperature	Engine oil	ISO 1375	50	150	°C	Resistance	322.8 - 18.6 Ω	5.1.31	65262	175	0x19
A2C3833410001	A2C3833410025	Temperature	Engine oil	ISO 2426	100	300	°F	Resistance	322.8 - 18.6 Ω	5.1.32	65262	175	0x19
A2C3833320001	A2C3833320025	Temperature	Cooling water	ISO 0246	40	120	°C	Resistance	287.4 - 22.7 Ω	5.1.29	65262	110	0x18
A2C3833330001	A2C3833330025	Temperature	Cooling water	ISO 1380	40	120	°C	Resistance	287.4 - 22.7 Ω	5.1.30	65262	110	0x18
A2C3833340001	A2C3833340025	Temperature	Cooling water	ISO 0246	100	250	°F	Resistance	450 - 30 Ω	5.1.33	65262	110	0x18
A2C3833350001	A2C3833350025	Temperature	Cooling water	ISO 0246	100	250	°F	Resistance	287.4 - 22.7 Ω	5.1.34	65262	110	0x18
A2C3832770001	A2C3832770025	Voltmeter		ISO 0247	8	16	VOLT		Terminal 30 - 31		65271	168	0x28
A2C3832780001	A2C3832780025	Voltmeter		ISO 0247	16	32	VOLT		Terminal 30 - 31		65271	168	0x28

TU00-0761-5207102

SingleViu™

Sensor curves

The 52 mm gauges are preset to be supplied by a commercial sensor with common sensor curves. The sensor curves may be changed via ► *ConfigTool*.

5.1.1 Sensor curve for Ammeter A2C38330600

Indication value [A]	-150	-100	-50	0	50	100	150
Input value [mV]	-60	-40	-20	0	+20	+40	+60

Characteristic curve predefined for shunt resistor A2C59514047 from Continental portfolio.

5.1.2 Sensor curve for Ammeter A2C38330700

Indication value [A]	-100	-50	0	50	100
Input value [mV]	-60	-30	0	+30	+60

Characteristic curve predefined for shunt resistor A2C59514045 from Continental portfolio.

5.1.3 Sensor curve for Ammeter A2C38330800

Indication value [A]	-60	-40	-20	0	+20	+40	+60
Input value [mV]	-60	-40	-20	0	+20	+40	+60

Characteristic curve predefined for shunt resistor A2C59514043 from Continental portfolio.

5.1.4 Sensor curve for Ammeter A2C38330900

Indication value [A]	-30	-20	-10	0	+10	+20	+30
Input value [mV]	-60	-40	-20	0	+20	+40	+60

Characteristic curve predefined for shunt resistor A2C59514041 from Continental portfolio.

5.1.5 Sensor curve for level gauge A2C38335500, A2C38331000, A2C38331200

Indication value	0 & E	1/8	1/4	3/8	1/2	5/8	3/4	7/8	1/1 & F
Input value [Ohm]	3	21	45	65	85	112	138	159	180

5.1.6 Sensor curve for level gauge A2C38327500, A2C38331300

Indication value	E	1/8	1/4	3/8	1/2	5/8	3/4	7/8	F
Input value [Ohm]	240	197	153	128	103	85	68	51	34

5.1.7 Sensor curve for level gauge A2C38331100, A2C38331500

Indication value	0	1/8	1/4	3/8	1/2	5/8	3/4	7/8	1/1
Input value [Ohm]	75	66	57	48	39	30	21	12	3

Characteristic curve predefined for fuel level sensors with input value 75 Ohm at indication value zero.

5.1.8 Sensor curve for level gauge A2C38331400

Indication value	E	1/8	1/4	3/8	1/2	5/8	3/4	7/8	F
Input value [Ohm]	0	11	23	34	45	56	68	79	90

Characteristic curve predefined for fuel level sensors with input value 75 Ohm at indication value E.

5.1.9 Sensor curve for level gauge A2C39163000

Indication value	0	1/8	1/4	3/8	1/2	5/8	3/4	7/8	1/1
Input value [Volt]	0,00	0,63	1,25	1,88	2,50	3,13	3,75	4,38	5,00

5.1.10 Sensor curve for Pressure gauge A2C38334400, A2C38334800, A2C38332400, A2C38333000

Indication value [psi]	0	20	30	50	70	80	100	120	130	150
Input value [Ohm]	10	39	53	79	104	116	139	160	170	188

Characteristic curve predefined for 10 bar pressure sensors from the Continental portfolio.

5.1.11 Sensor curve for Pressure gauge A2C38334500, A2C38331700

Indication value [bar]	0	1	2	3	4	5	6	7	8	9	10
Input value [Ohm]	10	31	52	71	90	107	124	140	156	170	184

Characteristic curve predefined for 10 bar pressure sensors from the Continental portfolio.

5.1.12 Sensor curve for Pressure gauge A2C38327100

Indication value [bar]	0	2	4	6	8	10	12	14	16
Input value [Volt]	0,5	1	1,5	2	2,5	3	3,5	4	4,5

Characteristic curve predefined for 10 bar pressure sensors from the Continental portfolio.

SingleViu™

5.1.13 Sensor curve for Pressure gauge A2C38327300

Indication value [bar]	0	25	50	75	100	125	150	175	200	225	250
Input value [Volt]	0,5	0,9	1,3	1,7	2,1	2,5	2,9	3,3	3,7	4,1	4,5

5.1.14 Sensor curve for Pressure gauge A2C38334600

Indication value [bar]	0	2,5	5	7,5	10	12,5	15	17,5	20	22,5	25
Input value [Ohm]	10	32	53	73	91	109	125	141	156	170	184

Characteristic curve predefined for 25 bar pressure sensors from the Continental portfolio.

5.1.15 Sensor curve for Pressure gauge A2C38327200

Indication value [bar]	0	5	10	15	20	25	30
Input value [Volt]	0,5	1,15	1,8	2,5	3,1	3,75	4,5

5.1.16 Sensor curve for Pressure gauge A2C38335000

Indication value [psi]	0	50	100	140	160	200	240	260	300	350	400
Input value [Ohm]	10	41	68	89	99	117	135	143	160	179	198

Characteristic curve predefined for 28 bar pressure sensors from the Continental portfolio.

5.1.17 Sensor curve for Pressure gauge A2C38327400

Indication value [psi]	0	50	100	150	200	250	300	350	400	450	500
Input value [Volt]	0,5	0,9	1,3	1,7	2,1	2,5	2,9	3,3	3,7	4,1	4,5

5.1.18 Sensor curve for Pressure gauge A2C38326900

Indication value [psi]	0	1	2	3	4	5	6	7	8	9	10
Input value [Volt]	0,5	0,9	1,3	1,7	2,1	2,5	2,9	3,3	3,7	4,1	4,5

5.1.19 Sensor curve for Pressure gauge A2C38327000

Indication value [psi]	0	25	50	75	100	125	150
Input value [Volt]	0,5	1,15	1,8	2,5	3,1	3,75	4,5

5.1.20 Sensor curve for pressure gauge A2C38331600

Indication value [bar]	0	0,5	1	1,5	2	2,5	3	3,5	4	4,5	5
Input value [Ohm]	11	29	47	65	82	100	117	134	151	167	184

Characteristic curve predefined for 5 bar pressure sensors from the Continental portfolio.

5.1.21 Sensor curve for pressure gauge A2C38332300

Indication value [psi]	0	10	20	25	30	35	40	60	80
Input value [Ohm]	240	198	177	148	120	104	82	63	34

5.1.22 Sensor curve for pressure gauge A2C38331900

Indication value [psi]	0	10	20	30	40	50	60	70	80
Input value [Ohm]	11	36	60	84	108	132	155	178	201

Characteristic curve predefined for 5 bar pressure sensors from the Continental portfolio.

5.1.23 Sensor curve for pressure gauge A2C38334900

Indication value [bar]	0	0,25	0,5	0,75	1	1,25	1,5	1,75	2
Input value [Ohm]	10	33	56	78	100	122	143	164	184

Characteristic curve predefined for 2 bar pressure sensors from the Continental portfolio.

5.1.24 Sensor curve for pressure gauge A2C38334700

Indication value [psi]	0	10	15	20	25	30	35	40	45	50	60
Input value [Ohm]	11	36	48	60	72	84	96	108	120	132	155

Characteristic curve predefined for 5 bar pressure sensors from the Continental portfolio.

5.1.25 Sensor curve for pyrometer A2C38330500

Indication value [°C]	0	125	250	375	500	625	750	875	1000
Input value [mV]	0	5	10	15	21	26	31	36	41

Characteristic curve predefined for pyrometer N03 320 264 from the Continental portfolio.

SingleViu™

5.1.26 Sensor curve for pyrometer A2C38330400

Indication value [°F]	0	250	500	750	1000	1250	1500	1750	2000
Input value [mV]	0	5	11	16	22	28	34	40	45

Characteristic curve predefined for pyrometer N03 320 264 from the Continental portfolio.

5.1.27 Sensor curve for temperature gauge A2C38335200

Indication value [°C]	60	80	100	120	140	160	180	200
Input value [Ohm]	483	265	151	85	53	32	21	14

5.1.28 Sensor curve for temperature gauge A2C38335300

Indication value [°F]	150	175	200	225	250	275	300	325	350	375	400
Input value [Ohm]	422	271	189	127	83	61	44	30	23	17	12

5.1.29 Sensor curve for temperature gauge A2C38335100, A2C38333200, A2C38333300

Indication value [°C]	40	50	60	70	80	90	100	110	120
Input value [Ohm]	291	197	134	97	70	51	38	29	22

Characteristic curve predefined for thermistor 92-027-004 from the Continental portfolio.

5.1.30 Sensor curve for temperature gauge A2C39163100

Indication value [°F]	0	50	80	100	110	125	125	150	175	200	225	250
Input value [Ohm]	500	500	500	320	257	257	185	112	71	47	31	22

Characteristic curve predefined for thermistor 92-027-004 from the Continental portfolio.

5.1.31 Sensor curve for temperature gauge A2C38333800, A2C38333900

Indication value [°C]	50	60	75	90	100	110	125	140	150
Input value [Ohm]	322	221	131	83	62	47	32	23	19

Characteristic curve predefined for thermistor 92-027-006 from the Continental portfolio.

5.1.32 Sensor curve for temperature gauge A2C38334100

Indication value [°F]	100	125	150	175	200	225	250	275	300
Input value [Ohm]	532	300	181	113	75	53	36	26	19

Characteristic curve predefined for thermistor 92-027-006 from the Continental portfolio.

5.1.33 Sensor curve for temperature gauge A2C38333400

Indication value [°F]	100	125	150	175	200	225	250
Input value [Ohm]	450	205	140	99	62	41	30

5.1.34 Sensor curve for temperature gauge A2C38333500

Indication value [°F]	100	125	150	175	200	225	250
Input value [Ohm]	320	185	112	71	47	31	22

Characteristic curve predefined for thermistor 92-027-004 from the Continental portfolio.

5.1.35 Sensor curve for Pressure gauge A2C18003100, A2C18003300, A2C18003400

Indication value [bar]	0	1	2	3	4	5	6	7	8	9	10
Input value [Volt]	0	0,5	1	1,5	2	2,5	3	3,5	4	4,5	5

5.2 Variants 80 mm

Article number		Gauge type	Scale			Analog input		CAN input		
Single packaging	OEM packaging (10 pieces)		Min	Max	Unit	Type	Sensor curve	PGN	SPN	CAN source address
A2C3832910001	A2C3832910010	Speedometer	0	120	km/h	Pulse	L	65265	84	0xA7
A2C3832920001	A2C3832920010	Speedometer	0	140	mph	Pulse	L	65265	84	0xA7
A2C3832930001	A2C3832930010	Speedometer	0	160	mph	Pulse	L	65265	84	0xA7
A2C3832940001	A2C3832940010	Speedometer	0	200	km/h	Pulse	L	65265	84	0xA7
A2C3832950001	A2C3832950010	Speedometer	0	300	km/h	Pulse	L	65265	84	0xA7
A2C3832880001	A2C3832880010	Speedometer	0	30	mph	Pulse	L	65265	84	0xA7
A2C3832890001	A2C3832890010	Speedometer	0	60	km/h	Pulse	L	65265	84	0xA7
A2C3832900001	A2C3832900010	Speedometer	0	90	mph	Pulse	L	65265	84	0xA7
A2C3832960001	A2C3832960010	Tachometer	0	20	RPM x 100	Pulse	L	61444	190	0x17
A2C3832970001	A2C3832970010	Tachometer	0	25	RPM x 100	Pulse	L	61444	190	0x17
A2C3832980001	A2C3832980010	Tachometer	0	30	RPM x 100	Pulse	L	61444	190	0x17
A2C3832990001	A2C3832990010	Tachometer	0	40	RPM x 100	Pulse	L	61444	190	0x17
A2C3833000001	A2C3833000010	Tachometer	0	50	RPM x 100	Pulse	L	61444	190	0x17
A2C3833010001	A2C3833010010	Tachometer	0	60	RPM x 100	Pulse	L	61444	190	0x17
A2C3833020001	A2C3833020010	Tachometer	0	80	RPM x 100	Pulse	L	61444	190	0x17

Sensor curve for 80 mm and 100 mm gauges

The indication value is linear to the number of pulses respectively the frequency of the input signal – “L” in the table above. For tachometers this proportionality factor be chosen between 0.1 and 999.9 pulses may. Default is a number of 6 pulses per motor turn.

For speedometers this proportionality factor be chosen between 1 and 65535. Default is a number of 8000 pulses per kilometer for metric speedometers and 8000 pulses per mile for mph speedometers.

5.3 Variants 100 mm

Article number		Gauge type	Scale			Analog input		CAN input		
Single packaging	OEM packaging (10 pieces)		Min	Max	Unit	Type	Sensor curve	PGN	SPN	CAN source address
A2C3832860001	A2C3832860010	Speedometer	0	120	km/h	Pulse	L	65265	84	0xA7
A2C3832850001	A2C3832850010	Speedometer	0	140	mph	Pulse	L	65265	84	0xA7
A2C3832840001	A2C3832840010	Speedometer	0	200	km/h	Pulse	L	65265	84	0xA7
A2C3832830001	A2C3832830010	Speedometer	0	300	km/h	Pulse	L	65265	84	0xA7
A2C3832870001	A2C3832870010	Speedometer	0	90	mph	Pulse	L	65265	84	0xA7
A2C3832820001	A2C3832820010	Tachometer	0	25	RPM x 100	Pulse	L	61444	190	0x17
A2C3832810001	A2C3832810010	Tachometer	0	30	RPM x 100	Pulse	L	61444	190	0x17
A2C3832800001	A2C3832800010	Tachometer	0	40	RPM x 100	Pulse	L	61444	190	0x17
A2C3832790001	A2C3832790010	Tachometer	0	50	RPM x 100	Pulse	L	61444	190	0x17

5.4 Package content

The single packaging contains each a gauge including the spinlock nut and safety instructions. The OEM-packaging with 52 mm gauges contains 25 sets of pieces.

The OEM packaging with 80 or 100 mm gauges contains 10 sets of pieces.

Further ► accessories are available separately.

6. Handling and Mounting instruction

6.1 Transportation and storage

Transport and store the device always in its packaging. Handle with care.

The allowed storage Temperature range is -40 °C to +85 °C (-40 °F to +185 °F), recommendation is storage at room temperature. Protect from dust and moisture.

NOTICE

Without ► connector the gauge is not tight against dust and fluids.

- » Perform the ► configuration before mounting the gauge.

6.2 Disconnect the power supply

CAUTION

Danger of battery short circuits!

Short circuits can cause cable fires, battery explosions and damage to other electronic systems.

- Remove voltage sources before electrical work.
- Remove ground cables of starter batteries and separate batteries.
- Protect battery from being inadvertently reconnected.

REMARK:

All data from volatile electronic memories in other device will be lost and need to be reprogrammed later.

- » Turn-off ignition and remove the ignition key.
- » If necessary, remove the main circuit switch.
- » Disconnect the negative terminal on all batteries.

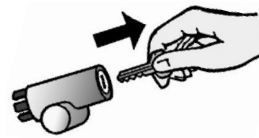

Fig. 6.1: Ignition off

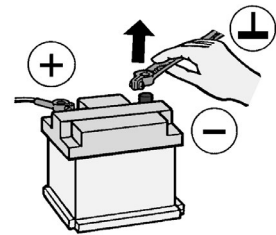

Fig. 6.2: Disconnect battery

6.3 Prepare the mounting space

CAUTION

Danger of inadequate mounting position!

Wrong mounting position of the gauge may affect other systems or the vehicle stability.

- The instrument must not impair the driver's field of vision.
- Do not install the instrument in the mechanical and electrical airbag area.
- Do not drill holes or ports in load-bearing or stabilizing stays or tie bars.
- Note the magnetic safe distance to the compasses. Recommendation: Minimum 30 cm.

REMARK:

The panel has to be sufficiently stabile and between 2 and 16 mm thick. The device may be mounted in any orientation between 0° and 90° according to DIN 16257.

- » Choose proper mounting location.
- » If need be, prepare the mounting hole, e.g. in the dash board.

Hole dimensions must comply to following values:

Gauge diameter	Hole diameter	Assembly depth
52 mm	52 + 0.5 mm	110 mm
80 mm	80 + 0.5 mm or 85 + 0.5 mm ¹⁾	110 mm
100 mm	100 + 0.5 mm	110 mm

Gauges with diameter 80 mm can be mounted in holes with diameter 85 mm.

- » Use the spinlock nut in orientation B with centering lip ahead as shown in the picture 6.3.

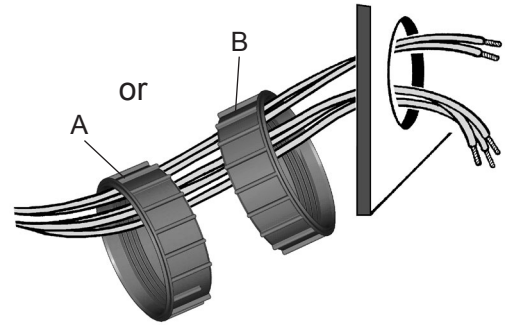

Fig. 6.3: Adjustment of 80 mm gauge mounting nut

NOTICE

- Pay attention to how lines and cable harnesses are laid so that you do not damage them.
- Drill small ports; enlarge and complete them, if necessary, using taper milling tools, saber saws, key-hole saws or files. Deburr edges.

- » If need be, lay the needed cables.

REMARK:

Cable strength acc. Molex requirement 1.20 – 2.69 mm in order to ensure tightness.
http://www.molex.com/pdm_docs/ps/PS-33472-000.pdf

CAUTION

Danger of sudden loss of vehicle functionality!

Faulty connections or unsuitable routing can cause short circuits or failure of other components, possibly after long time of operation.

- Only use fused voltage supply. Recommendation: 5 Amp fuse.
- Use cables with sufficient cross-sectional area and insulation.
- When installing electrical cables, use the provided cable ducts and harnesses; however, do not run cables parallel to ignition cables or to cables that lead to large electricity consumers.
- Fasten cables with cable ties or adhesive tape. Do not run cables over moving parts. Do not attach cables to the steering column. Ensure that cables are not subject to tensile forces.
- If cables are run through drill holes, protect them using rubber sleeves or the like.
- Use only a soft soldering process or commercially available crimp connector to create new cable connections.
- Make crimp connections with cable crimping pliers only.
- Insulate exposed stranded wires to prevent short circuits

6.4 Mounting of the connector

NOTICE

Use only a cable stripper to strip the cable and adjust it so that stranded wires are not damaged or separated

REMARK:

The MOLEX product family MX150 contains different crimping contacts in series 33012. When choosing the contact be aware to have a tinned surface and the correct diameter of cables for according size classes. <http://www.molex.com/molex/products/listview.jsp?channel=products&sType=s&query=33012>
The MOLEX recommendation for sealed connectors is 33012-2004 or 33012-3004.

- » Attach the crimp contacts onto the cable ends.
- » Connect the cables according to the following pinning to be MOLEX connectors. Refer to chapter 3.4 for wiring diagrams.

8 pin connector, MOLEX 334724801, for all gauges:

Pin	Description	Remark
1	Terminal 30	Battery Plus (12/24 V _{DC})
2	Terminal 31	Battery Minus (Ground)
3	Sensor ground	Ground reference for sensor signal
4	Terminal 15	Ignition
5	Sensor input	Contact for analog sensor signal
6	Terminal 58	Illumination
7	CAN High	Input for CAN bus SAE J1939
8	CAN Low	Input for CAN bus SAE J1939

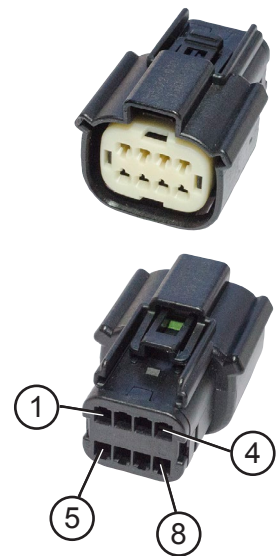

Fig. 6.4: MOLEX 8-pin connector

12 pin connector, MOLEX 334721201, for gauges with diameter 80 or 100 mm:

Pin	Description	Remark
1	CAN High	Opt. input for CAN bus SAE J1939
2	CAN Low	Opt. input for CAN bus SAE J1939
3	Termination resistance 1	CAN termination resistance 120 Ohm
4	Termination resistance 2	CAN termination resistance 120 Ohm
5	Digital input 1	Control of tell-tale 1
6	Digital input 2	Control of tell-tale 2
7	Digital input 3	Control of tell-tale 3
8	Digital input 4	Control of tell-tale 4
9	Digital input 5	Control of tell-tale 5
10	Digital input 6	Connection for external push-button
11	Digital output 1	Connection for external buzzer
12	Digital input 7	Configuration pin

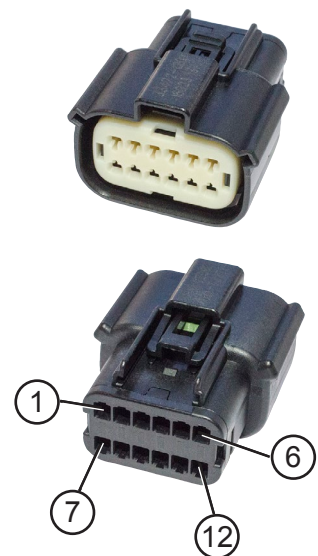

Fig. 6.5: MOLEX 12-pin connector

- » Close unused positions with blanking plug, MOLEX 34345-0001, or use suitable MOLEX mat seal with blocked terminals.

NOTICE

Level of protection IP67 will only be achieved if all connector positions occupied or closed with blanking plug. Without connector, the gauge reaches protection level IP40.

6.5 Mounting the gauge

- » Put the gauge into the mounting hole and turn it into intended orientation.

REMARK:

Make sure that the seal lays untwisted between the panel and the front ring.

- » Hand-tighten the spinlock nut, max. 4 Nm (400 Ncm).

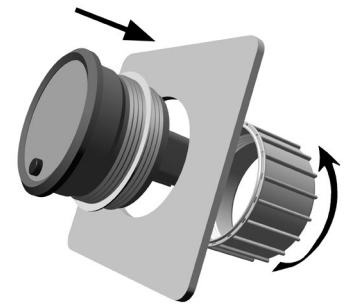

Fig. 6.6: Mount the gauge.

- » Put on the connector onto the gauge until it audibly locks.

REMARK:

Detailed information on the MOLEX system MX150 like drawings, product specification, mounting instruction, crimp instruction:
<http://www.molex.com/ind/mx150.html>.

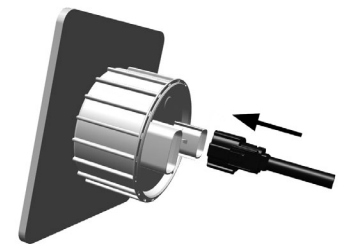

Fig. 6.7: Plug in connector.

6.6 Reconnect the power supply

CAUTION

Danger of defect or disabled systems!

Vehicle components may have been harmed or disconnected unintentionally.

Functionality failures of one system endangers the safety of the whole vehicle / machine.

- Check indication values of the gauge for plausibility.
- Check other components of vehicle/machine for functionality.

- » Reconnect the battery after inspecting the connection.

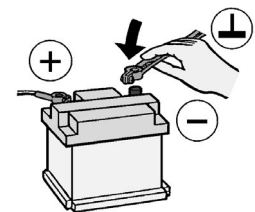

Fig. 6.8: Connect battery.

- » If necessary, reinsert the main circuit switch. Turn on the ignition and conduct a functional test of the device and the whole vehicle.
- » Reprogram all device that lost their data in volatile memories.

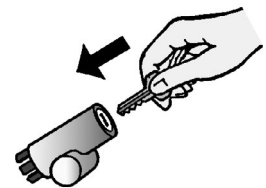

Fig. 6.9: Ignition on.

7. Configuration and initial setup

The *SingleViu* gauges are programmed for analog operation mode per default and can be directly used in many cases. Please refer to chapter 4, technical data, for details, e.g. for sensor curves. A configuration may be necessary nonetheless to adopt the functionality to the specific vehicle or individual preferences, e.g. for operation via CAN bus.

7.1 Configuration via *SingleViu ConfigTool*

The *SingleViu* ► *ConfigTool* is a computer program to easily parametrize the *SingleViu* gauges.



7.1.1 Prerequisites and preparation

The *SingleViu ConfigTool*, is a computer program that requires the operating system Windows 7, Windows 8 or Windows 10. The platform.NET in version 4.5.2 or higher must be installed. The *ConfigTool* itself can be provided by your local *SingleViu* specialist dealer.

Administrator rights are required to execute the installer file.

- » Unzip and start the file
- » Follow the user menu.

The *ConfigTool* is installed in the selected register and is applicable immediately. The desktop-icon helps starting the Config-Tool easily

Configuring of *SingleViu* gauges occurs via Unified Diagnostic Services (UDS) according to ISO 14229. The *ConfigTool* is programmed for usage with ► CAN boxes of company Vector and with CAN boxes of company Peak-Systems, that need to be installed separately.

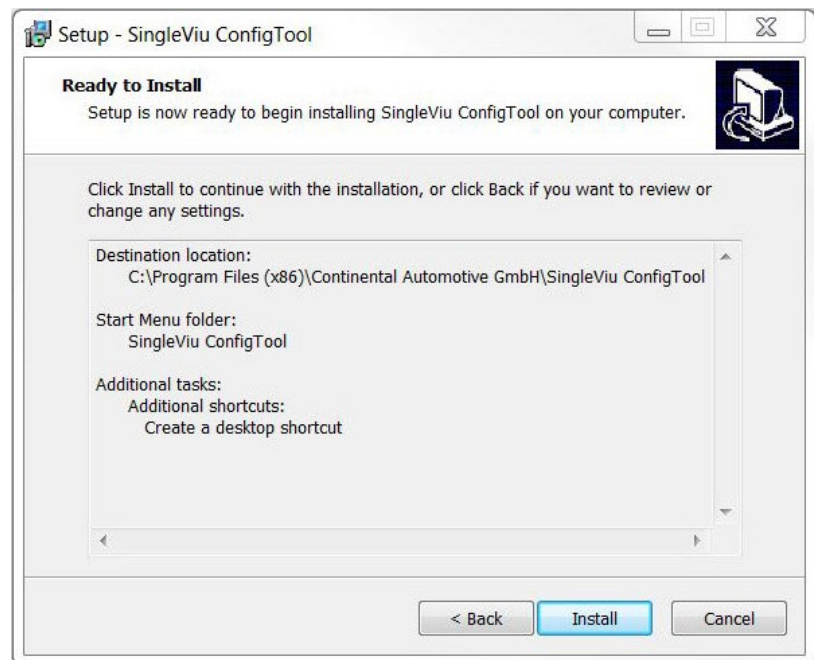

Fig. 7.1: Setup

Configurations will be stored as files with filename extension „.acg“. Per default all factory settings of all gauges are available and stored using the part number. Own configuration can be added.

The configuration of the gauges before mounting into the vehicle is recommended. During configuration only one gauge may be connected to the CAN bus; thus it must be performed for every single gauge individually.

For configuration use the “*SingleViu* Programming/Test cable” from ► Accessories.

Proceed as follows:

- » Start the gauge
 - Connect the brown cable (terminals 30, 15 and 58; battery plus, ignition and illumination) to DC voltage plus, nominal voltage 12 or 24 Volts.
 - Connect the black cable (terminal 31, ground) to DC voltage minus.
 - Put on the connector onto the gauge until it audibly locks.
- » Prepare the CAN connection.
 - Connect the Sub-D via 120 Ohm termination to the CAN box.
 - Connect the CAN box with the computer.
- » Start the *ConfigTool* by clicking the program file on desktop or in start menu.

The user mask consists of following items:

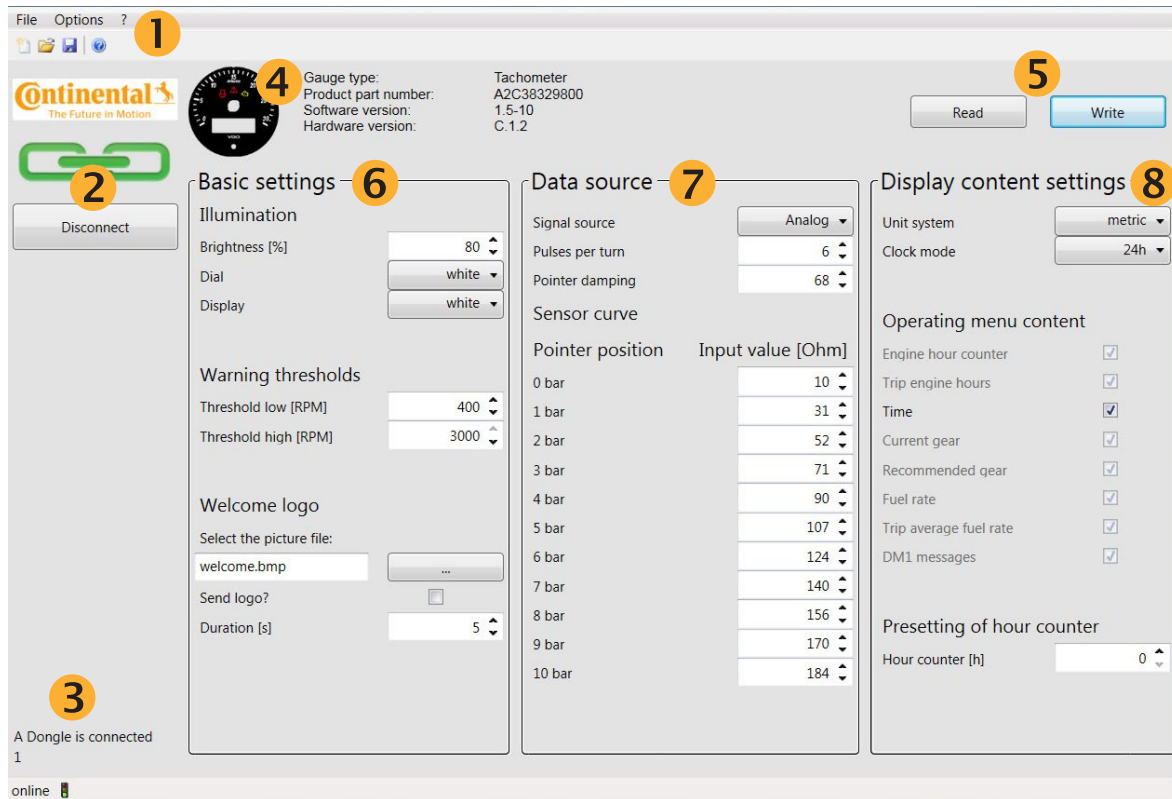
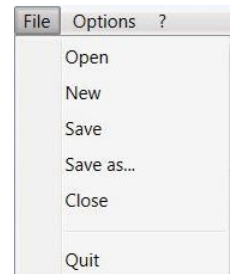

Fig. 7.2: Exemplary illustration of the ConfigTool user mask. The set of items depends on gauge variant.

1 Basic functions

The menu item „File“ offers following activities:

- Open: Load an existing configuration. Only such configuration can be loaded that comply to the current gauge.
- New: Only in offline mode: Load a default configuration and edit.
- Save: Store the current configuration under current filename.
- Save as ...: Store the current configuration under another filename.
- Close: Only in offline mode: Close the current configuration.
- Quit: Close the *ConfigTool*.



The menu item „Options“ offers following activities:

- Logging level: Advanced users select a level of additional information on usage of the *ConfigTool*.
- Language: Select the language for the *ConfigTool*. A change of the selected language will be applied after restart of the *ConfigTool*. There are the languages English (default), German and French available.

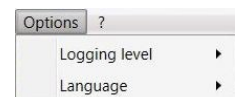

The menu item „?“ offers following activities:

- Help: This chapter of the user manual will be opened.
- About ...: Information on the *ConfigTool*.

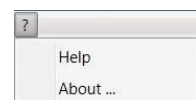

2 CAN connection

The red or green status indication „offline“ / „online“ shows the current CAN connection status.

The button „Connect“ / „Disconnect“ allows to start or to finish a connection with the CAN bus.

3

Dongle

The dongle status shows if a ►dongle is connected and displays its workshop number.

4

General gauge data

General gauge information of the current *SingleViu* gauge is shown in this area. This includes a dial picture, the gauge type, the product part number of the unpacked gauge and the version numbers of hardware and firmware.

5

Read / Write

The upload-button (Read) is to load the current device configuration from the device and display it in the user mask. The download-button (Write) is to store the current configuration from the user mask into the device. In case of unconnected CAN bus or unchanged configuration, these two buttons will be deactivated.

6

Basic settings

Brightness [%]

The brightness of the background illumination of dial and display can be adapted in the range of 0% for no illumination to 100% for full illumination brightness. Default setting is 80%.

Dial

The color of the dial's background illumination can be changed. The drop-down menu provides the predefined options white (default), amber, red, yellow, blue and green.

Display

For gauges with display, the color of its background illumination can be changed. The drop-down menu provides the predefined options white (default), amber, red, yellow, blue and green.

Warning thresholds

The lower and the upper warning thresholds for the internal tell-tale can be changed. At indication values beyond these thresholds, the ►tell-tale 1 is activated.

Welcome logo

For gauges with display, a path to a bitmap file may be chosen to upload it as welcome logo. This picture must be a monochrome bitmap file with resolution 132 x 43 pixels. With activated checkbox the picture will be downloaded in next write sequence.

The duration for displaying the Welcome logo in seconds after ignition can be selected. At the maximum value of 255, the welcome logo will be displayed permanently.

7

Data Source

Signal source

Per drop-down menu it can be chosen if data shall be provided via ►CAN bus SAE J1939 or if an analog value shall be read. The tachometer A2C38330300 can only be operated in CAN mode.

Pulses per turn (tachometers) or per kilometer (speedometers)

This function is active for tachometers and speedometers with diameter 80 or 100 mm. The number of pulses per motor turn, per kilometer or per mile must be entered.



Danger of wrong speed indication value!

A wrong setting leads to wrong indication value of motor rotational speed or vehicle speed for the driver. This may result in dangerous driving situations. Also the operating license may become invalid.

- Type in the correct number of pulses for the vehicle at hand.
- If need be, evaluate the number of pulses beforehand or look it up in the sensor documentation
- Operate the gauge only in analog mode if correct number of pulses is known

Message PV onto CAN

When this function is selected, the gauge will send the imported value onto ► CAN bus. This function is not available for tachometers.

Pointer damping

This value parametrizes the PT1 filter for pointer agility damping.

Sensor curve

The predefined ► sensor curve is configured for main relevant sensors. The sensor curve still can be adapted by setting the analog input value.
This function is activated only in analog mode for gauges with potentially non-linear sensor curve that is with resistive analog input.

8 Display content settings

This subsection will be shown only for gauges will display.

Unit system

It is possible to select if the displayed values shall be in metric units (default in gauges with metric dial scale) or in US customary units (default in speedometers with miles per hour).

Clock mode

It is possible to select between 24-hour (default) and 12-hour clock mode.

Content of the operation menu

The menu items can be included or excluded by checking or unchecking the corresponding box.

REMARK:

The predefined menus differ between speedometers and tachometers.
Please refer to chapter 6.2 and 6.3 for details.

REMARK:

Some items can be internally calculated by the gauge and will be available in analog mode also.
Other data can only be obtained from the CAN bus.

Presetting the hour counter (tachometers) and the odometer (speedometers)

In analog mode, tachometers calculate the total operation hours and speedometers calculate the total odometer. This internal value can be updated.

This function is only available for authorized workshops with ► dongle. The odometer value is to be entered in the selected unit system, either Kilometer or Miles.

7.2 Configuration via push-button (only for gauges with diameter 80 or 100 mm)

Some certain settings can be configured via internal ► push-button or an external button, pin 10 of the 12-pin connector.

Therefore the gauge provides a configuration menu consisting of 4 items. This menu allows the driver to set comfort functions.

For the initial configuration an extension to the configuration menu with three additional items is available. These settings may not be altered in regular operation. To access this menu, connect pin 12 of the 12-pin connector to battery plus.

CAUTION

Danger of wrong speed indication value!

A wrong setting leads to wrong indication value of motor rotational speed or vehicle speed for the driver. This may result in dangerous driving situations. Also the operating license may become invalid.

- Set the correct number of pulses for the vehicle at hand.
- If need be, evaluate the number of pulses beforehand or look it up in the sensor documentation
- Operate the gauge only in analog mode if correct number of pulses is known.
- Perform this initial configuration on workbench and not within the vehicle.
- Remove the contact to pin 12 after initial configuration. Do not keep this pin connected in regular operation.

Procedure to access the configuration menu:

- » Power the gauge which means to connect terminal 30/31 to DC voltage, nominal value 12 or 24 V.
- » if need be, switch-off terminal 15.
- » only for initial configuration: connect pin 12 of 12-pin connector to voltage supply, (terminal 30).
- » press and hold the key.
- » switch-on terminal 15.
- » release the key.

Procedure to exit the configuration menu:

- » Wait for 30 seconds without button press. The configuration menu will be closed and the gauge starts regular operation mode.
- Or
- » Switch-off ignition (terminal 15) and restart without pressing the button.

General instruction:

A short button press („SP“, < 2sec.) changes the momentarily shown value.

A long button press („LP“, > 2sec.) switches to be next item.

SingleViu™

7.2.1 Units

Per default, the metric system is selected for display information values. It can be changed into US customary units and back. Gauges with explicitly US customary units on the dial scale are configured accordingly.

7.2.2 Clock

Per default, the 24-hour clock mode is selected. It can be changed into the 12-hour clock mode and back.

7.2.3 Brightness

Per default, 80% brightness is selected. It can be changed in 10% steps.

7.2.4 Color of the dial background illumination

Per default, a white background illumination is selected. It can be changed into several other predefined colors.

7.2.5 Color of display background illumination

Per default, a white background illumination is selected. It can be changed into several other predefined colors.

Only at initial setup

7.2.6 Selection of signal source

Per default, the analog signal source is selected. It can be changed to CAN input and back.

7.2.7 Setting the number of pulses

In case of analog input, the correct number of pulses must be set. Default values are 6 pulses per motor turn for tachometers and 8,000 pulses per kilometer for speedometers (12875 pulses per mile).

7.2.8 Setting the warning thresholds

Upper and lower thresholds to activate the warning tell-tale can be set. Default values are the scale limits. Lower default threshold for tachometers is 400 RPM.

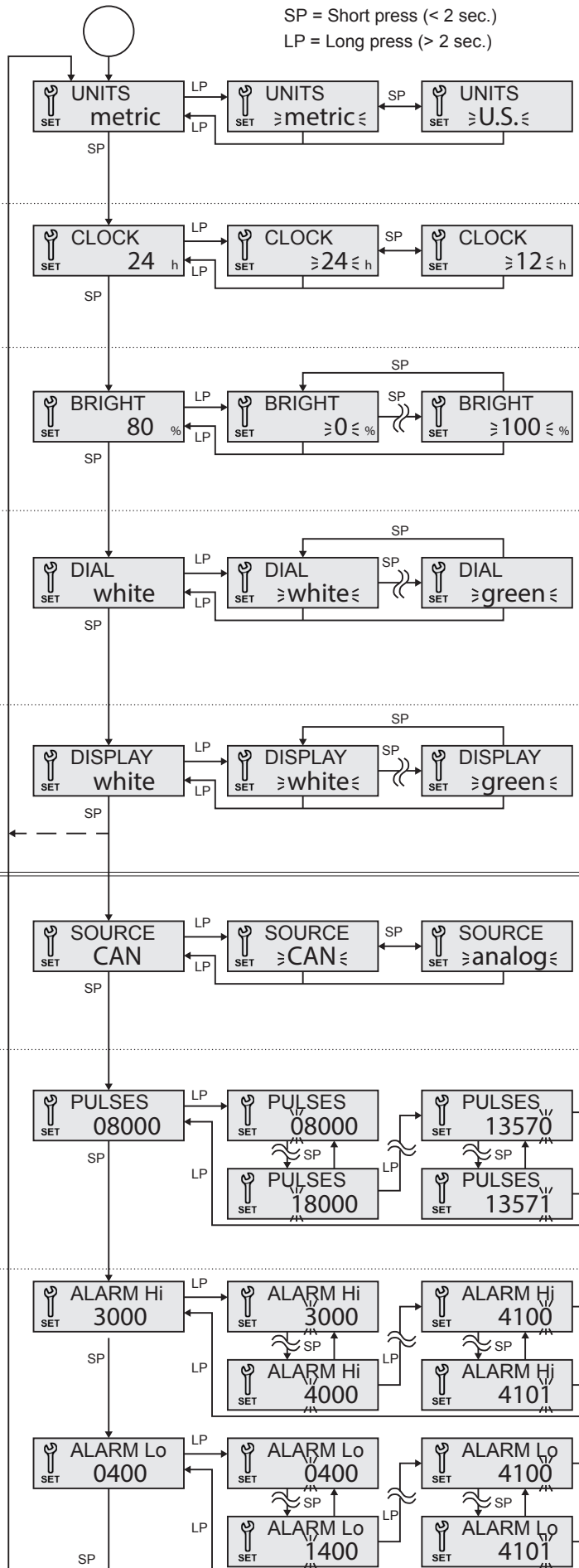

8. Operating menu

General instruction:

A short button press („SP“, < 2sec.) switches to the next menu item or increments the momentarily shown value.
 A long button press („LP“, > 2sec.) switches to the change mode, within a change mode to the next digit or back to the menu.

8.1 Operating menu for gauge with diameter 52 mm

SingleViu gauges with diameter 52 mm show the according indication value and possibly a warning signal but do not contain any functionality for user operation.

8.2 Operating menu for speedometers (diameter 80 and 100 mm)

At every ignition it is possible to start the ► configuration menu by pressing the button. Otherwise and if applicable the ► welcome logo will be shown. Afterwards the display content changes to regular operation menu. Its items may freely selected and arranged in ► ConfigTool. Below the default operation menu is explained.

8.2.1 Odometer

Analog mode: Internal calculation
 CAN mode: PGN 65248 / SPN 245

8.2.2 Trip odometer

Analog mode: Internal calculation
 CAN mode: PGN 65248 / SPN 244

8.2.3 Time

Analog mode: Internal calculation
 CAN mode: PGN 65254 / SPN 960 and 961
 In analog mode the clock needs to be set after every ignition.

8.2.4 Instantaneous fuel economy

CAN mode only: PGN 65266 / SPN 184

8.2.5 Average fuel economy

CAN mode only: PGN 65266 / SPN 185

8.2.6 Instantaneous fuel rate

CAN mode only: PGN 65266 / SPN 183

8.2.7 Average fuel rate

CAN mode only: PGN 65203 / SPN 1029

8.2.8 Power take out

CAN mode only: PGN 65265 / SPN 976

8.2.9 Failure messages DM1

CAN mode only: PGN 65226

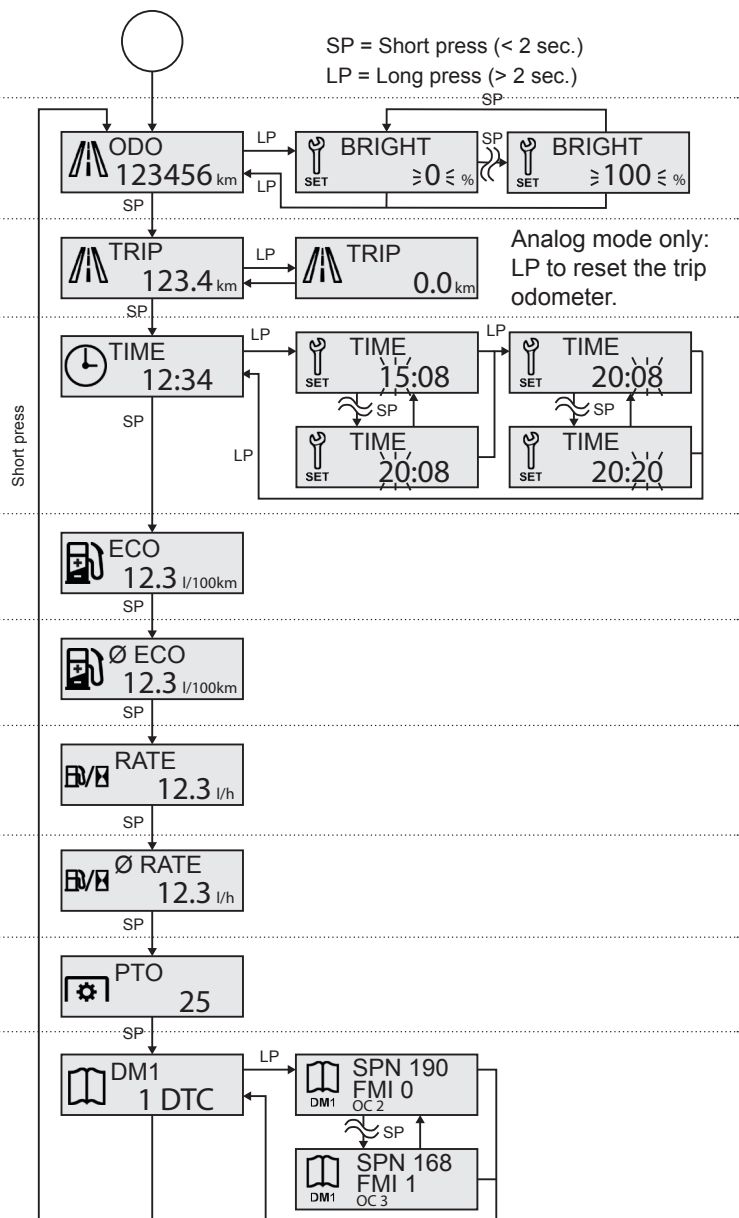

TU00-0761-5207102

8.3 Operating menu for tachometers (diameter 80 and 100 mm)

At every ignition it is possible to start the ► configuration menu by pressing the button. Otherwise and if applicable the ► welcome logo will be shown.

Afterwards the display content changes to regular operation menu. Its items may freely selected and arranged in ► *ConfigTool*. Below the default operation menu is explained.

8.3.1 Total hour counter

Analog mode: Internal calculation
CAN mode: PGN 65253 / SPN 247

8.3.2 Trip engine running time

CAN mode only: PGN 65200 / SPN 1036

8.3.3 Time

Analog mode: Internal calculation.
CAN mode: PGN 65254 / SPN 960 and 961
In analog mode the clock needs to be reset after every power switch-off.

8.3.4 Current gear

CAN mode only: PGN 61445 / SPN 523

8.3.5 Recommended gear

CAN mode only: PGN 65195 / SPN 1113

8.3.6 Instantaneous fuel rate

CAN mode only: PGN 65266 / SPN 183

8.3.7 Average fuel rate

CAN mode only: PGN 65203 / SPN 1029

8.3.8 Failure messages DM1

CAN mode only: PGN 65226

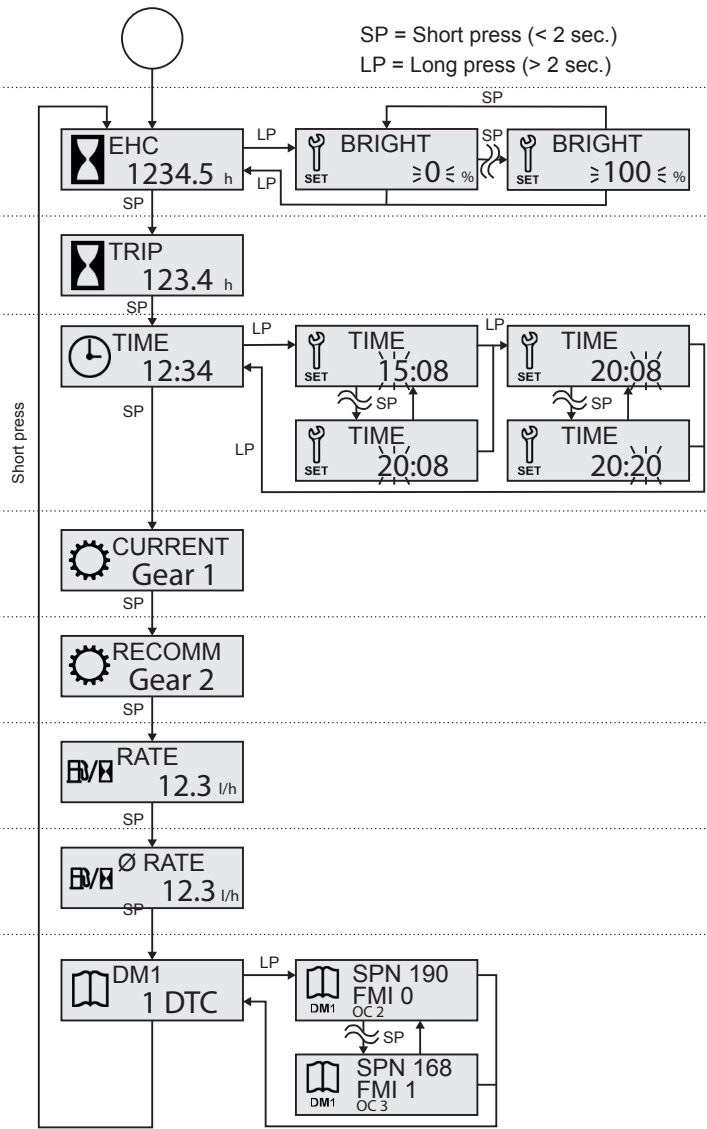

9. Replacement of gauges of predecessor series

SingleViu gauges can technically replace most of the devices of the predecessor series Viewline, World Wide Gauges and CANcockpit.

- » For the electrical connection of a *SingleViu* gauge to your existing cable harness you may use the corresponding adapter cable.

NOTICE

Level of protection IP67 will only be achieved if all connector positions occupied or closed with blanking plug MOLEX 34345-0001.

REMARK:

In case of totally unoccupied 12-pin-connector, the blind connector MOLEX 33472-1258 can be used.

9.1 Replacement of Viewline

- » Connect the adapter cable „*SingleViu* Adapter cable Viewline 8pin“, part number 2910000301300, with the *SingleViu* gauge and the vehicle 8-pin-connector.
- » Put on the connector onto the gauge until it audibly locks.

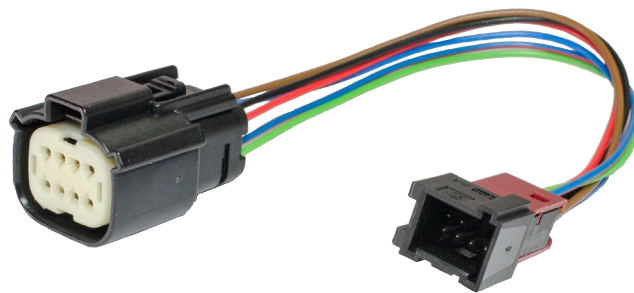

Fig. 9.1: *SingleViu* Adapter cable Viewline 8pin

In case of *SingleViu* gauges with diameter 80 or 100 mm it is possible to connect an external button and an alarm output, equally as in the Viewline gauge which is to be replaced.

- » To do so, connect the adapter cable „*SingleViu* Adapter cable Viewline 14pin“, part number 2910000301400, with the *SingleViu* gauge and the vehicle 14-pin-connector.
 - » Put on the connector onto the gauge until it audibly locks.
- In difference to Viewline the external push-button has to be connected to terminal 31, refer to the wiring diagram, fig. 3.4.
- » Connect the extern push-button accordingly.

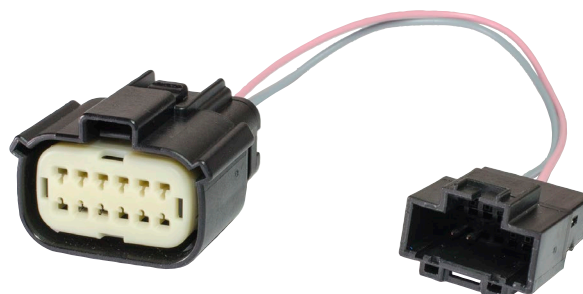

Fig. 9.2: *SingleViu* Adapter cable Viewline 14pin

9.2 Replacement of World Wide Gauges (WWG; Cockpit international, Cockpit Vision)

SingleViu gauges can technically replace the electrical gauges of the WWG platform. For the electric contact, please use the adapter cable „SingleViu Adapter cable WWG“, part number 2910000301500.

The wires are color coded as follows:

- Red: Battery plus (terminal 30)
- Black: Ground (terminal 31)
- Brown: Ignition (terminal 15)
- Blue: Sensor ground
- Green: Sensor signal
- Red-blue: Illumination (terminal 58)

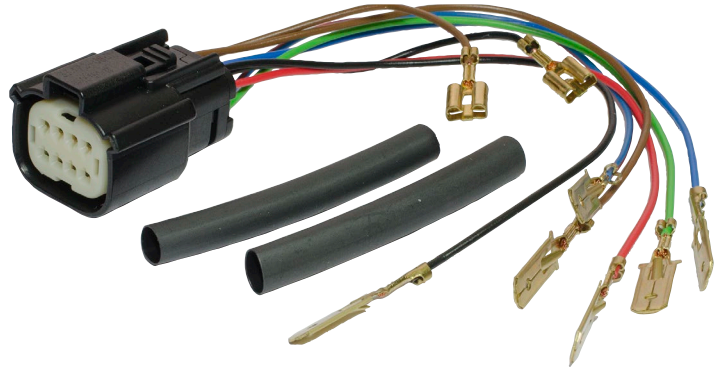

Fig. 9.3: SingleViu Adapter cable WWG

NOTICE

» » Insulate all open cable connectors with heat shrink tube or with adhesive insulating tape.

9.2.1 Replacement of tachometers or speedometers (80 or 100 mm)

WWG speedometers and tachometers with diameters 80 or 100 mm were connected to the vehicle connector part number 999-115-016. For illumination there are up to two lamps which are connected between a power line (terminal 58) and vehicle ground (terminal 31).

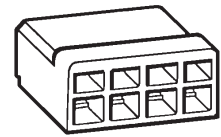

Procedure to apply the adapter cable:

- » Connect the brown wire of the adapter cable to pin 1 or 2 of the WWG vehicle connector, depending on which pin was connected before.
- » Connect the black wire of the adapter cable to pin 3 of the WWG vehicle connector.
- » Connect the green wire of the adapter cable to pin 4 of the WWG vehicle connector.
- » Connect the red-blue cable of the adapter cable to one of the cable shoes that terminate the illumination power lines.
- » Connect the red wire of the adapter cable to the brown wire's cable shoe.
- » Connect the blue wire of the adapter cable to the black wire's cable shoe.
- » Put on the connector onto the SingleViu gauge until it audibly locks.
- » Put on the blind connector MOLEX 33472-1258.

9.2.2 Replacement of a tachometer (52 mm)

The WWG tachometer with diameter 52 mm was connected to single wires which terminate in cable shoes. See adjacent picture for reference.

Procedure to apply the adapter cable:

- » Connect the brown wire of the adapter cable to the cable shoe of the plus pin wire.
- » Connect the black wire of the adapter cable to the cable shoe of the minus pin wire.
- » Connect the green wire of the adapter cable to the cable shoe of the pin 2.
- » Connect the red-blue cable of the adapter cable to the cable shoe of the illumination's power line.
- » Connect the red wire of the adapter cable to the brown wire's cable shoe.
- » Connect the blue wire of the adapter cable to the black wire's cable shoe.
- » Put on the connector onto the SingleViu gauge until it audibly locks.

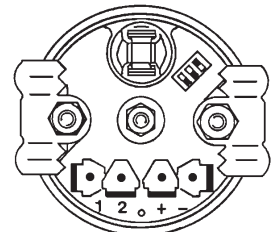

9.2.3 Replacement of pressure, temperature or level gauges (52 mm)

The WWG pressure, temperature or level gauges with diameter 52 mm were connected to single wires which terminate in cable shoes. See adjacent picture for reference.

Procedure to apply the adapter cable:

- » Connect the brown wire of the adapter cable to the cable shoe of the plus pin wire.
- » Connect the black wire of the adapter cable to the cable shoe of the minus pin wire.
- » Connect the green wire of the adapter cable to the cable shoe of the pin S.
- » Connect the red-blue cable of the adapter cable to the cable shoe of the illumination's power line.
- » Connect the red wire of the adapter cable to the brown wire's cable shoe.
- » Connect the blue wire of the adapter cable to the black wire's cable shoe.
- » Put on the connector onto the *SingleViu* gauge until it audibly locks.

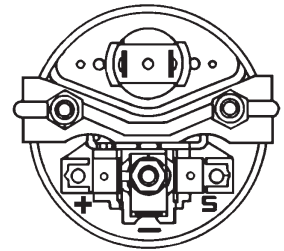
9.2.4 Replacement of a voltmeter (52 mm)

The WWG voltmeter with diameter 52 mm was connected to single wires which terminate in cable shoes. See adjacent picture for reference.

Procedure to apply the adapter cable:

- » Connect the brown wire of the adapter cable to the cable shoe of the plus pin wire.
- » Connect the black wire of the adapter cable to the cable shoe of the minus pin wire.
- » The green wire of the adapter cable remains unused.
- » Connect the red-blue cable of the adapter cable to the cable shoe of the illumination's power line.
- » Connect the red wire of the adapter cable to the brown wire's cable shoe.
- » The blue wire of the adapter cable remains unused.
- » Put on the connector onto the *SingleViu* gauge until it audibly locks.

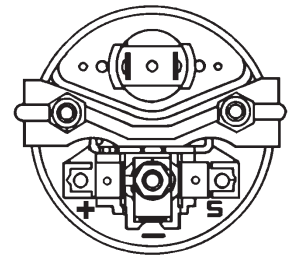

9.2.5 Replacement of an ammeter (52 mm)

SingleViu gauges can replace WWG ammeters of type B.

The WWG ammeter with diameter 52 mm was connected to single wires which terminate in cable shoes. See adjacent picture for reference.

Procedure to apply the adapter cable:

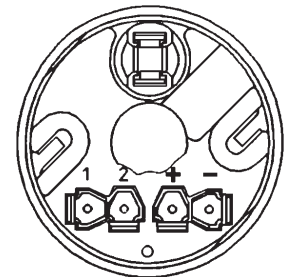
- » Connect the brown wire of the adapter cable to the cable shoe of the plus pin wire.
- » Connect the black wire of the adapter cable to the cable shoe of the minus pin wire.
- » Connect the green wire of the adapter cable to the cable shoe of the pin 1.
- » Connect the red-blue cable of the adapter cable to the cable shoe of the illumination's power line.
- » Connect the red wire of the adapter cable to the brown wire's cable shoe.
- » Connect the blue wire of the adapter cable to the cable shoe of the pin 2.
- » Put on the connector onto the *SingleViu* gauge until it audibly locks.

9.2.6 Replacement of a pyrometer (52 mm)

The WWG pyrometer with diameter 52 mm was connected to single wires which terminate in cable shoes. See adjacent picture for reference.

Procedure to apply the adapter cable:

- » Connect the brown wire of the adapter cable to the cable shoe of the plus pin wire.
- » Connect the black wire of the adapter cable to the cable shoe of the minus pin wire.
- » Connect the green wire of the adapter cable to the cable shoe of the pin 1.
- » Connect the red-blue cable of the adapter cable to the cable shoe of the illumination's power line.
- » Connect the red wire of the adapter cable to the brown wire's cable shoe.
- » Connect the blue wire of the adapter cable to the cable shoe of the pin 2.
- » Put on the connector onto the *SingleViu* gauge until it audibly locks.

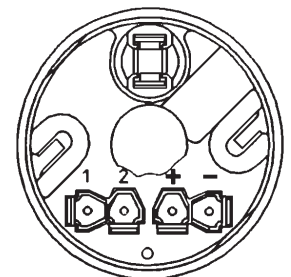

9.3 Replacement of CANcockpit

In CANcockpit all data are read by a master device which feeds the linked satellite gauges. In contradiction of this concept, every *SingleViu* gauge is a stand-alone device and needs to be connected to power and data lines individually.

For every CANcockpit gauge one adapter cable „*SingleViu* Adapter cable CANcockpit“, part number 2910000301600, is needed. This cable on the one hand taps all necessary signals for the *SingleViu* gauge at hand and on the other hand, provides them to following gauges. This way all *SingleViu* gauges can be connected successively.

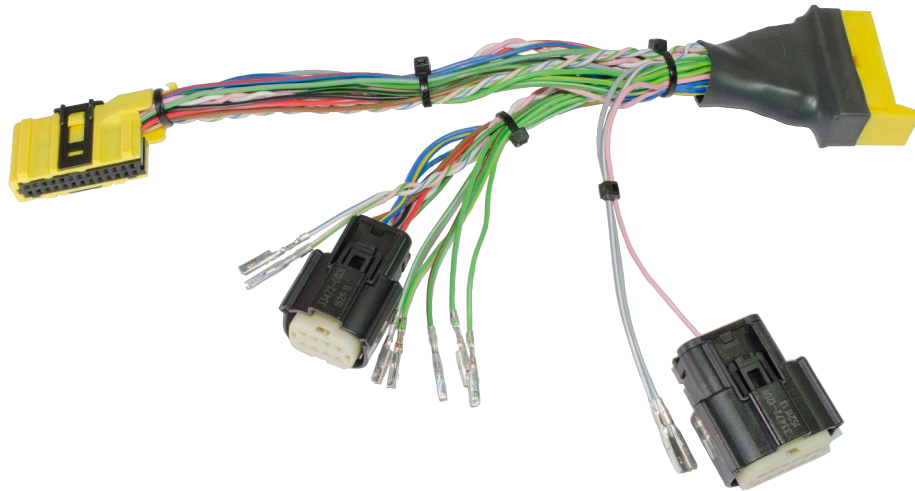

Fig. 9.4: „*SingleViu* Adapter cable CANcockpit“

Procedure for every *SingleViu* gauge:

- » In case of an analog input signal chose the corresponding green wire and connect it to pin 5 of the MOLEX 8 pin connector.
- » In case of CAN signal input chose the corresponding CAN bus (1 or 2) and connect the two wires as follows: white wire, CAN High, to pin 7 of the MOLEX 8 pin connector and pink wire, CAN Low, to pin 8 of the MOLEX 8 pin connector.
- » In case of a *SingleViu* gauge with diameter 80 or 100 mm the alarm output can be connected additionally. To do so, chose the corresponding grey wire and connect it to pin 11 of the MOLEX 12 pin connector.
- » Cut the rose wire in case an external switch shall not be effective for the *SingleViu* gauge at hand.
- » Connect the adapter cable to the vehicle connector.
- » Put on the MOLEX connector or both of them onto the *SingleViu* gauge until it audibly locks.

10. Maintenance

Gauges of the *SingleViu*-family so not need any technical maintenance.

NOTICE

Defect gauges cannot be used anymore and have to be replaced.

- » If necessary clean the front lense with commercial pane cleaner and soft cloth.

11. Shutdown and Disposal

11.1 Disconnect the power supply

CAUTION

Danger of battery short circuits!

Short circuits can cause cable fires, battery explosions and damage to other electronic systems.

- Remove voltage sources before electrical work.
- Remove ground cables of starter batteries and separate batteries.
- Protect battery from being inadvertently reconnected.

REMARK:

All data from volatile electronic memories in other device will be lost and need to be reprogrammed later.

- » Turn-off ignition and remove the ignition key.
- » If necessary, remove the main circuit switch.
- » Disconnect the negative terminal on all batteries.

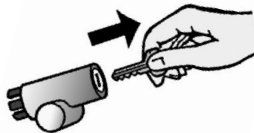

Fig. 11.1: Ignition off

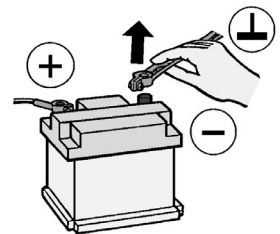

Fig. 11.2: Disconnect battery

11.2 Dismantling

- » Unplug connector
- » Unplug mounting nut
- » Remove gauge

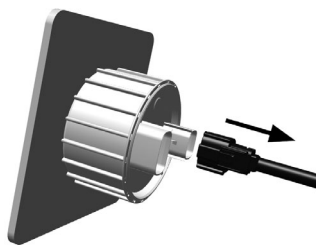

Fig. 11.3: Unplug connector.

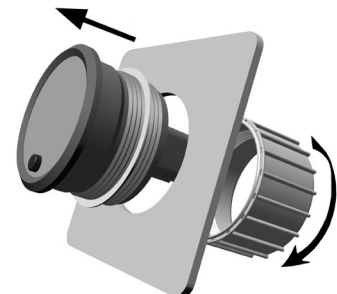

Fig. 11.4: Remove gauge.

11.3 Reconnect the power supply

CAUTION

Danger of defect or disabled systems!

Vehicle components may have been harmed or disconnected unintentionally.

Functionality failures of one system endangers the safety of the whole vehicle / machine.

- Check indication values of the gauge for plausibility.
- Check other components of vehicle/machine for functionality.

- » Reconnect the battery.

- » If necessary, reinsert the main circuit switch. Turn on the ignition and conduct a functional test of the whole vehicle.
- » Reprogram all devices that lost their data in volatile memories.

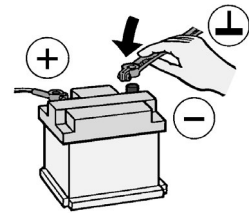

Fig. 11.5: Connect battery.

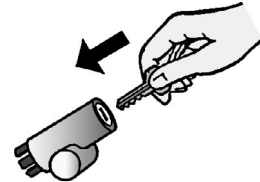

Fig. 11.6: Ignition on.

11.4 Decommissioning and disposal

This device is an electronic device and as such to be disposed of. Therefore the exact material composition may be learned from the international material database of the automotive industry (► IMDS).

The packaging consists of a PE plastic bag per gauge and a cardboard box.

The OEM packaging also contains a FEP foam inlay.

- » Bring these packagings into the local disposal system



12. Accessories and spare parts

12.1 Spare parts

Spinlock nuts can be ordered as spare parts.

- spinlock nut for 52 mm gauges: part number A2C10434200
- spinlock nut for 80/85 mm gauges: part number A2C39712100
- spinlock nut for 100 mm gauges: part number A2C10434100

In case of replacing the front lense or the bezel, please contact your local ► specialist dealer.

12.2 Adapter cables

Prefabricated cables can be used to easily connect SingleViu gauges to the vehicle cable harness.

- contact cable „SingleViu 8 pin cable“: part number 2910000484200
- contact cable „SingleViu 12 pin cable“: part number 2910000484300

To connect gauges during configuration via ConfigTool, the programming cable may be used:

- Programming cable „SingleViu Programming/Test cable“: part number 2910000401700

In case you want to replace a gauge of the predecessor series by a *SingleViu* gauge you may use an adapter cable for the electric connection.

- adapter cable „SingleViu Adapter cable Viewline 8pin“: part number 2910000301300
- adapter cable „SingleViu Adapter cable Viewline 14pin“: part number 2910000301400
- adapter cable „SingleViu Adapter cable WWG“: part number 2910000301500
- adapter cable „SingleViu Adapter cable CANcockpit“: part number 2910000301600

Schematic drawings of accessory cables are available from your local ► specialist dealer.

12.3 SingleViu ConfigTool, Programming dongle and CAN Boxen

Please contact your specialist dealer. Product trainings by Continental may be scheduled on demand.

For presetting of two reserved parameters, odometer in speedometer gauges and EHC in tachometer gauges, a dongle is required. A user license must be signed before purchase, please contact your ► specialist dealer. The CANcockpit dongle X11-602-000-015 and the Viewline dongle A2C59515259 can be reused or ordered.

For CAN boxes of companies Vector or Peak-System please contact them directly or their local distributor. See web pages www.vector.com and www.peak-system.com.

To connect gauges during configuration via ConfigTool, the programming cable may be used:

- Programming cable „SingleViu Programming/Test cable“: part number 2910000401700

12.4 MOLEX connector and crimp contacts

Equipment to complete the vehicle's cable harness:

- 8-pin connector: MOLEX 334724801, for all gauges
- Other connectors, also with blocked terminal positions, are available.
- 12-pin connector: MOLEX 334721201, additionally for gauges with diameter 80 or 100 mm
- Other connectors, also with blocked terminal positions, are available.
- blanking plug: MOLEX 34345-0001, to block single terminal positions.
- blind connector: MOLEX 33472-1258, with all 12 terminal positions blocked.
- crimp contact: A range of different crimp contacts is available in MOLEX series 33012. Selection depends on surface, cable diameter and payoff reel direction.

This equipment is not part of the Continental portfolio. You may find it at your electronic distributor.

Continental Automotive GmbH

Sodener Straße 9
65824 Schwalbach am Taunus
Germany
Tel. +49 6196 87-0

Heinrich-Hertz-Straße 45
78052 Villingen-Schwenningen
Germany
Tel. +49 7721 67-0

www.continental-corporation.com

Legal Notice

The reproduction, distribution and utilization of this document as well as the communication of its contents to others without express authorization is prohibited. Offenders will be held liable for the payment of damages. All right reserved in the event of the grant of a patent, utility model or design.