

APEX and SOLIX

Operations Manual

532793-1EN_A



 **HUMMINBIRD®**

SIMPLY. CLEARLY. BETTER.

THANK YOU!

Thank you for choosing Humminbird®, the #1 name in marine electronics. Humminbird has built its reputation by designing and manufacturing top quality, thoroughly reliable marine equipment. Your Humminbird is designed for trouble-free use in even the harshest marine environment. In the unlikely event that your Humminbird does require repairs, we offer an exclusive Service Policy. For complete details, see the separate warranty card included with your unit. We encourage you to read this operations manual carefully in order to get the full benefit from all the features and applications of your Humminbird product.

Contact Humminbird Technical Support at humminbird.com or call 1-800-633-1468.

 **WARNING!** This device should not be used as a navigational aid to prevent collision, grounding, boat damage, or personal injury. When the boat is moving, water depth may change too quickly to allow time for you to react. Always operate the boat at very slow speeds if you suspect shallow water or submerged objects.

 **WARNING!** The electronic chart in your Humminbird unit is an aid to navigation designed to facilitate the use of authorized government charts, not to replace them. Only official government charts and notices to mariners contain all of the current information needed for the safety of navigation, and the captain is responsible for their prudent use.

 **WARNING!** Compass Safe Distance: The control head must be installed at least 4 feet [1.2 meters] from the compass or other magnetic equipment on the boat. Also, see your compass installation guide for details.

 **WARNING!** This device is granted for use in Mobile only configurations in which the antennas used for this transmitter must be installed to provide a separation distance of at least 8 inches [20 cm] from all person and not be co-located with any other transmitters except in accordance with FCC and Industry Canada multi-transmitter product procedures.

 **WARNING!** Humminbird is not responsible for the loss of data files [waypoints, routes, tracks, groups, recordings, etc.] that may occur due to direct or indirect damage to the unit's hardware or software. It is important to back up your control head's data files periodically. Data files should also be saved to your PC before restoring the unit's defaults or updating the software. Review the information in this manual for details.

 **WARNING!** Disassembly and repair of this electronic unit should only be performed by authorized service personnel. Any modification of the serial number or attempt to repair the original equipment or accessories by unauthorized individuals will void the warranty.

 **WARNING!** Do not travel at high speed with the unit cover installed. Remove the unit cover before traveling at speeds above 20 mph.

 **WARNING!** The user shall maintain 20 cm separation from the RF device to ensure compliance with RF exposure.

 **NOTE:** Some features discussed in this manual require a separate purchase, and some features are only available on international models. Every effort has been made to clearly identify those features. Please read the manual carefully in order to understand the full capabilities of your model.

 **NOTE:** The illustrations in this manual may not look the same as your product, but your unit will function in a similar way.

 **NOTE:** To purchase accessories or any additional equipment for your control head configuration, visit our Web site at humminbird.com or contact Humminbird Customer Service at 1-800-633-1468.

 **NOTE:** The procedures and features described in this manual are subject to change without notice. This manual was written in English and may have been translated to another language. Humminbird is not responsible for incorrect translations or discrepancies between documents.

 **NOTE:** Product specifications and features are subject to change without notice.

 **NOTE:** Humminbird verifies maximum stated depth in saltwater conditions, however actual depth performance may vary due to transducer installation, water type, thermal layers, bottom composition, and slope.

ROHS STATEMENT: Product designed and intended as a fixed installation or part of a system in a vessel may be considered beyond the scope of Directive 2002/95/EC of the European Parliament and of the Council of 27 January 2003 on the restriction of the use of certain hazardous substances in electrical and electronic equipment.

ATTENTION INTERNATIONAL CUSTOMERS: Products sold in the U.S. are not intended for use in the international market. Humminbird international units provide international features and are designed to meet country and regional regulations. Languages, maps, time zones, units of measurement, and warranty are examples of features that are customized for Humminbird international units purchased through our authorized international distributors.

To obtain a list of authorized international distributors, please visit our Web site at humminbird.com or contact Humminbird Technical Support at **[334] 687-6613**.

APEX™, AutoChart®, AutoChart® LIVE, ChartSelect®, CoastMaster®, Cross Touch®, Down Imaging®, DualBeam PLUS™, Dual Spectrum™, Fish ID+™, FishSmart™, Humminbird®, Humminbird Basemap™, i-Pilot® Link™, LakeMaster®, MEGA 360 Imaging®, MEGA Imaging™, MEGA Down Imaging™, MEGA Down Imaging+™, MEGA Live Imaging™, MEGA Side Imaging™, MEGA Side Imaging+™, Real Time Sonar™, RTS Window™, SI™, Side Imaging®, SmartStrike™, SOLIX®, Structure ID™, SwitchFire®, WhiteLine™, X-Press™ Menu, and Zero Line Map Card™ are trademarked by or registered trademarks of Johnson Outdoors Marine Electronics, Inc.

Airmar is a registered trademark of Airmar Technology Corp.

Adobe, Acrobat, Adobe PDF, and Reader are either registered trademarks or trademarks of Adobe Systems Incorporated in the United States and/or other countries.

Baekmuk Batang, Baekmuk Dotum, Baekmuk Gulim, and Baekmuk Headline are registered trademarks owned by Kim Jeong-Hwan.

The Bluetooth® word mark and logos are registered trademarks owned by the Bluetooth SIG, Inc. and any use of such marks by Johnson Outdoors, Inc. is under license. Other trademarks and trade names are those of their respective owners.

Gentoo™ is a trademark of Gentoo Foundation, Inc.

microSD and SD are trademarks or registered trademarks of SD-3C, LLC in the United States, other countries or both.

Navionics® is a registered trademark of Navionics S.p.A.



NMEA 2000® is a registered trademark of the National Marine Electronics Association.

TABLE OF CONTENTS

| | | | |
|--|------------|--|------------|
| Warnings | 2 | Manage your Navigation Data | 119 |
| Introduction | 6 | Manage Waypoints | 120 |
| Using Humminbird Manuals on your Mobile Device or Computer . . . | 7 | Manage Routes | 123 |
| The APEX/SOLIX Control Head | 8 | Manage Tracks | 125 |
| Keypad and Touch Screen | 9 | Manage Groups | 128 |
| SD Card Slots | 15 | Delete All Navigation Data | 129 |
| Power On/Off | 16 | Import/Export Navigation Data | 129 |
| Getting Started | 17 | AutoChart LIVE Overview | 130 |
| Update Software | 26 | Plan your Map | 130 |
| The Home Screen | 30 | Prepare the Control Head for Mapping | 131 |
| The Menu System | 39 | Record your Custom Map | 134 |
| Views | 45 | Stop Recording | 135 |
| Edit the On-Screen View | 48 | Correct Data | 136 |
| The View Options Menu | 57 | Display the AutoChart Live Map | 137 |
| Create a New View | 60 | Adjust the Map Display Settings | 139 |
| Set up an Instrument View | 63 | Customize the Bottom Hardness Display Settings | 143 |
| Set up an HDMI View | 65 | Customize the Vegetation Display Settings | 146 |
| Chart Overview | 67 | Mosaic Live Overview | 149 |
| Map Source Overview | 68 | For Best Performance | 149 |
| Navigation Alarms Overview | 78 | Open the Mosaic Live Menu | 150 |
| Man Overboard (MOB) Navigation | 82 | Customize the Mosaic Live Display | 152 |
| Customize the Chart View | 83 | Autopilot Overview | 156 |
| Change the Chart View Data Overlays | 93 | Radar Overview | 158 |
| Chart and Radar | 94 | Radar Transmission Settings | 159 |
| Introduction to Navigation | 95 | Adjust the Transmission Range | 161 |
| Navigation Menu Overview | 96 | Radar Alarms | 162 |
| Navigation X-Press Menu | 96 | Customize the Radar View | 165 |
| Mark Menu | 97 | Open the Radar Preferences Menu | 165 |
| Go To Menu | 97 | Change the Radar View Data Overlays | 167 |
| Info Menu | 99 | Adjust Radar Signal Settings | 169 |
| Cursor Menu | 101 | EBL/VRM | 172 |
| Waypoints | 102 | Navigation in Radar View | 174 |
| Routes | 107 | AIS and MARPA | 176 |
| Search | 114 | AIS and MARPA Alarms | 176 |
| Tracks | 116 | AIS and MARPA Display Settings | 178 |
| | | AIS Overview | 180 |
| | | MARPA Targets | 187 |

TABLE OF CONTENTS

| | |
|--|------------|
| Sonar Overview | 192 |
| Sonar Setup | 198 |
| Sonar Alarms | 199 |
| 2D Sonar Overview | 200 |
| Customize the 2D Sonar View | 201 |
| Open the 2D Sonar Preferences Menu | 201 |
| Change the 2D Sonar View Overlays | 206 |
| Adjust 2D Sonar Display Settings | 207 |
| Side Imaging Overview | 212 |
| Customize the Side Imaging View | 214 |
| Open the Side Imaging Preferences Menu | 214 |
| Change the Side Imaging View Overlays | 216 |
| Adjust Side Imaging Display Settings. | 217 |
| Down Imaging Overview | 220 |
| Customize the Down Imaging View. | 221 |
| Open the Down Imaging Preferences Menu | 221 |
| Change the Down Imaging View Overlays | 223 |
| Adjust Down Imaging Display Settings. | 224 |
| Use Cursor and Zoom in Sonar Views (2D, SI, DI) | 227 |
| Navigation in Sonar Views (2D, SI, DI) | 229 |
| Sonar Recording | 231 |
| Images Tool | 232 |
| Installation Information | 237 |
| Set up or Change Transducer Settings [advanced settings] . . . | 238 |
| Configure Humminbird Radar [Installation and Repair only] . . | 245 |
| Configure the Control Head | 248 |
| Set up a NMEA 2000 Network | 253 |
| Set up your Humminbird Network | 262 |
| Change the Network Name | 268 |
| Manage your Control Head | 270 |
| Specifications | 272 |
| Statements and Acknowledgements | 293 |
| Contact Humminbird | 299 |

INTRODUCTION

The instructions in this manual describe the APEX and SOLIX control head operations. For an overview of functions, see the Quick Start Guide included with your product.

Build your Network: Some of the features shown in this manual require a separate purchase. MEGA 360, MEGA Live, Radar, Talon, Raptor, AIS, Compass/Heading Sensor, Ethernet Switch, i-Pilot Link, etc. require a separate purchase. To install each accessory, use the installation guide provided with it, or download the guide from our Web site at humminbird.com.

Register and Update: As you build your Humminbird network, it is important to register your products and keep your software up to date. Visit our Web site at humminbird.com to register your Humminbird products, update control head and accessory software, and purchase additional equipment. Also, see **Update Software** in this manual for more information.

USING HUMMINBIRD MANUALS ON YOUR MOBILE DEVICE OR COMPUTER

The Humminbird manuals for your control head and accessories can be downloaded to your mobile device or computer. If you prefer to use a hard copy for reference, this manual may be printed.

Download the Manual to your Mobile Device

1. Download the free Adobe Acrobat Reader app to your mobile device.
2. Go to our Web site at humminbird.com, and click Support > Manuals.
3. Select the PDF for your control head model or accessory, and save it to your device.
4. Open the Adobe Acrobat Reader app.
5. Open the Humminbird manual.

Download the Manual to your Computer

1. Download the free Adobe Acrobat Reader software from <http://get.adobe.com/reader/>, and install it on your computer.
2. Go to our Web site at humminbird.com, and click Support > Manuals.
3. Select the PDF for your control head model or accessory, and save it to your computer.
4. Open Adobe Acrobat Reader.
5. Open the Humminbird manual.

Jump to a Section: Click a section name in the Bookmarks panel. Bookmarks can be expanded and collapsed by clicking on the plus [+] or minus [-] icons.

Search for Words or Phrases: Press and hold the Ctrl F keys on your keyboard. Type the word(s) into the text box.

Print: To print, confirm the page sizing is 8.5 x 11" and set to Fit. Set the page orientation to Portrait.

Using the Manual



THE APEX/SOLIX CONTROL HEAD

The APEX and SOLIX control heads includes CrossTouch, which allows you to use both the touch screen and keypad to make selections. Review this section for an overview of touch and keypad functions.

APEX Control Head

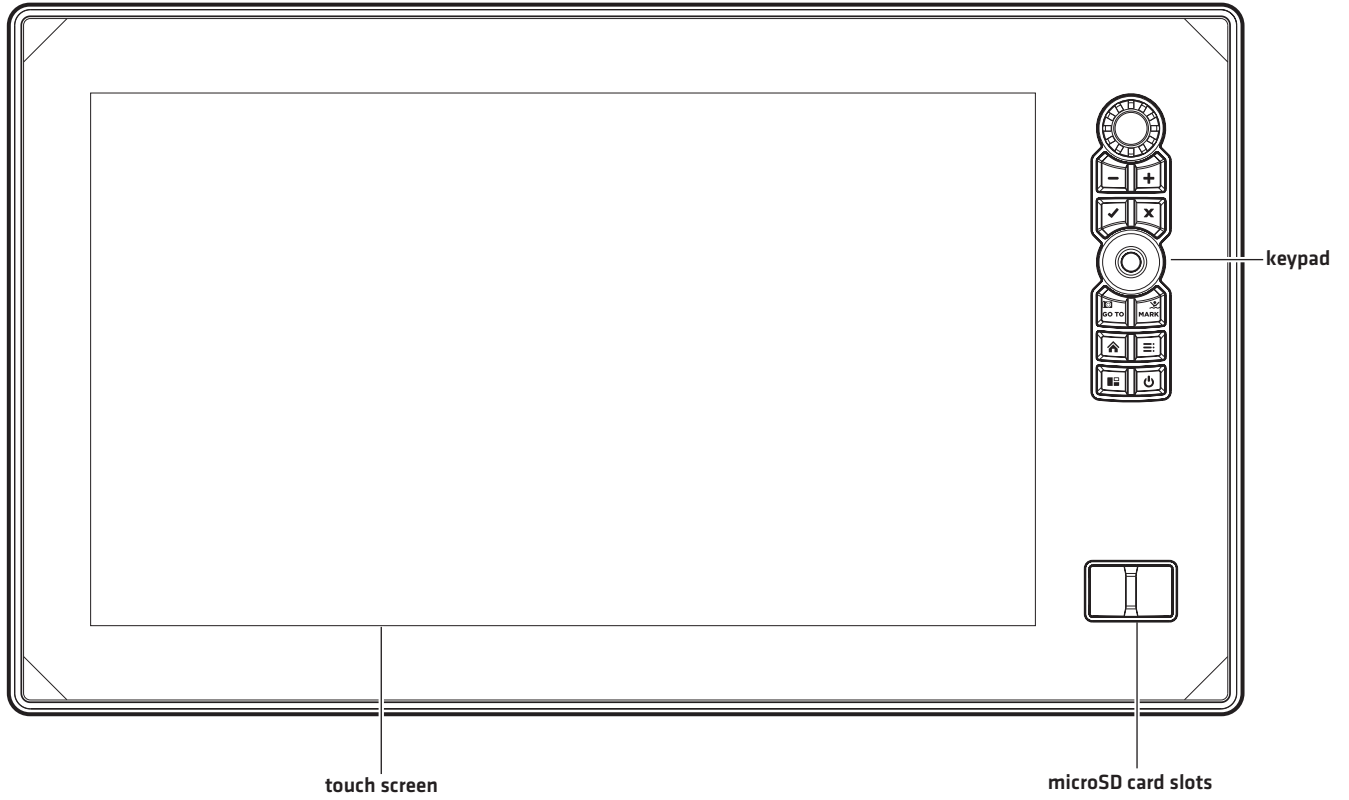

SOLIX Control Head

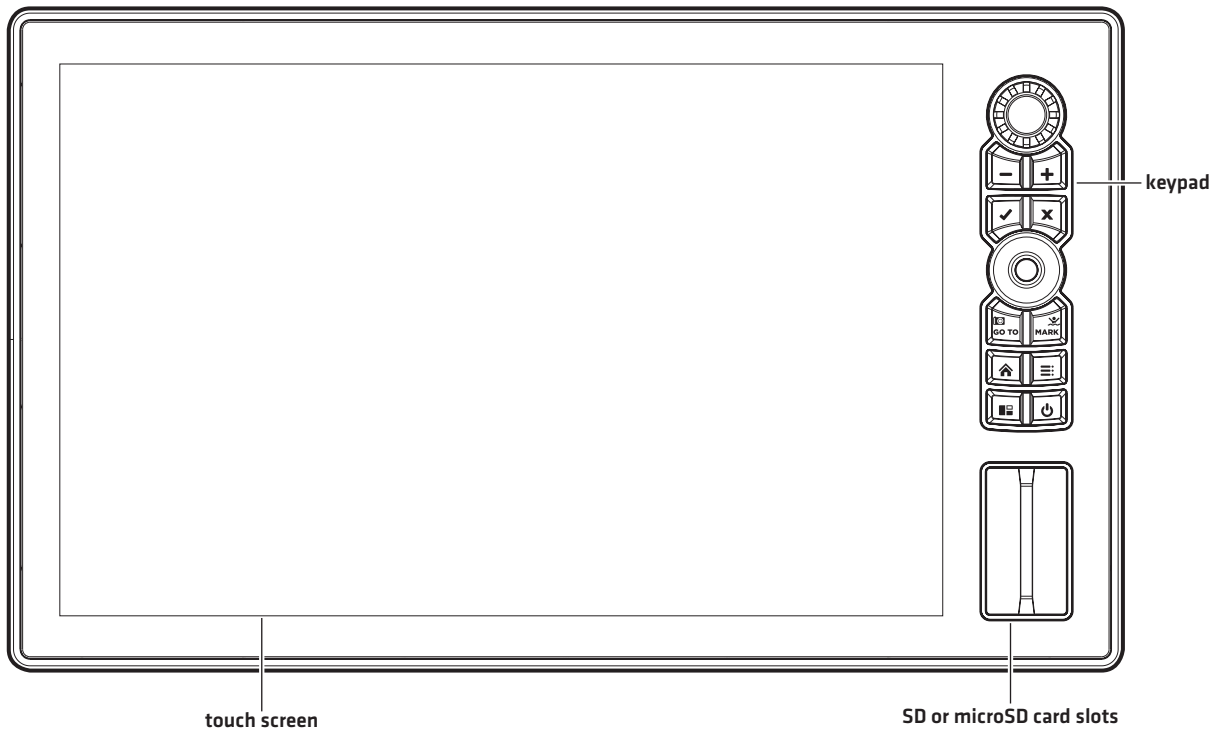

Keypad Functions

The functions for each key are described here. To apply the key functions, see each section of this manual.

Joystick

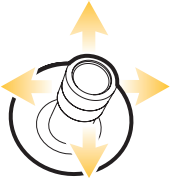

Move Functions

Move to select a view, tool, widget, or menu.

Move to activate and/or move the cursor across the displayed view.

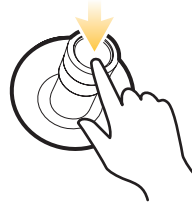

(Down) Press Functions

Open your selected view, tool, widget, menu, or submenu.

Mark a route point.

Rotary Dial

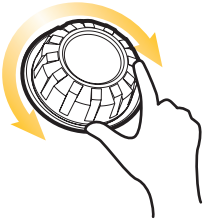

Turn Functions

Turn to adjust menu settings.

Turn to adjust the sensitivity in Sonar Views.





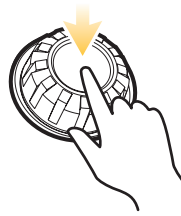





Turn to zoom in and out in Chart View.

Turn to adjust in Radar View.



(Down) Press Functions

Press the Rotary dial to open the Favorite Views widget.

| Key | Name | Key Press Function(s) | Key Press Function(s) |
|---|-----------------------------|--|--|
|  | POWER key | Powers on the control head. During operation, this key opens the Power X-Press Menu. | Powers off the control head. |
|  | ENTER key | Starts a command. Selects, or turns on, a setting. Opens menus. Opens the Info menu and the Cursor menu. | Adjusts menu settings. May vary with the displayed view. |
|  | EXIT key | Closes an open menu or dialog box. Turns off an alarm. Exits Cursor mode. Returns to the last displayed view from the Home screen. | Closes all open submenus and menus. |
|  | GO TO & Screen Snapshot key | Opens the Go To menu for navigation functions [see <i>Routes</i> for details]. | Screen Snapshot: Saves the on-screen view [image]. See <i>Images Tool</i> . |
|  | PANE key | Activates the Side Bar [the side bar is highlighted in yellow]. Use the Joystick to scroll through the side bar widgets. Selects a pane in a multi-pane view [the selected pane is highlighted in yellow. See <i>Views</i> .] | |
|  | MARK & Man Overboard key | Press TWICE to mark waypoints. | Man Overboard: Starts Man Overboard [MOB] Navigation. See <i>Man Overboard [MOB] and Introduction to Navigation</i> . |
|  | HOME key | Displays the Home screen. See <i>The Home Screen</i> . | |
|  | ZOOM In key | Changes the scale of the view to show a closer perspective. | |
|  | ZOOM Out key | Changes the scale of the view to show a wider view. | Zoom out all the way. |
|  | MENU key | Opens the X-Press Menu for the on-screen view and operation mode. Press TWICE to open the Settings tool. | Returns to the last-used Settings tool tab. See <i>The Menu System</i> . |

Touch Screen Functions

The touch screen actions are also determined by the view displayed on the screen.

Using the Touch Screen (SOLIX)

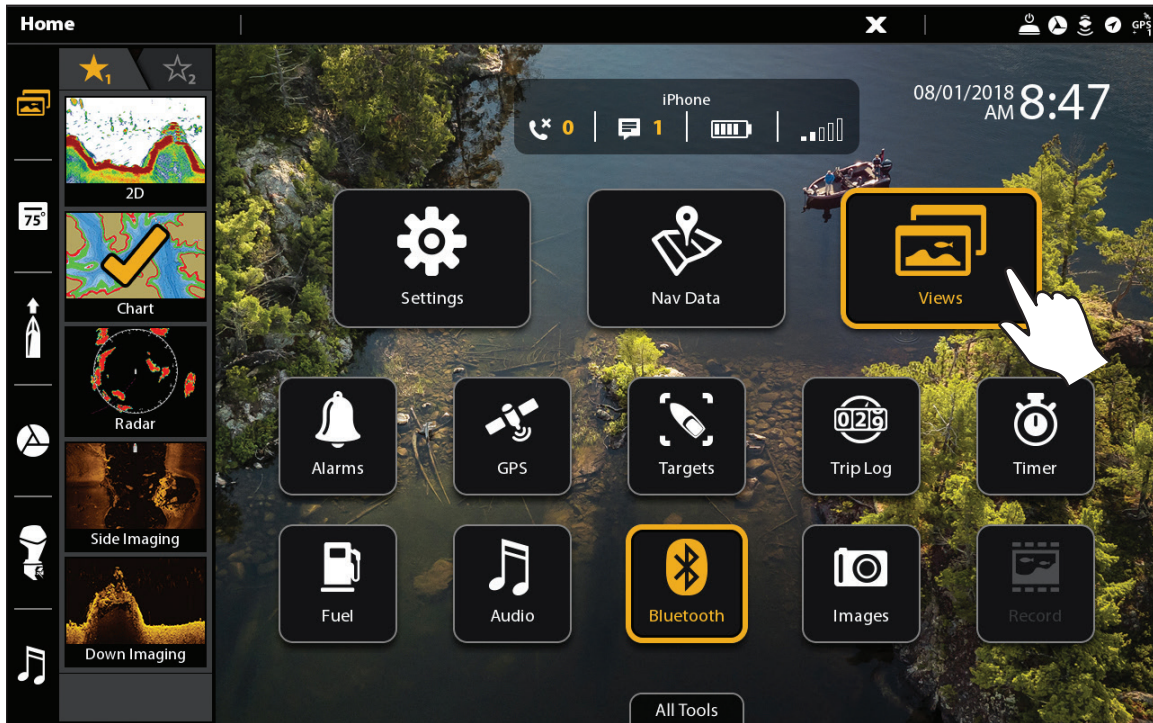

Swipe Functions

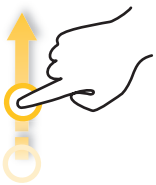

One Finger Swipe (vertical)

Browse Menus: Scroll through a menu or list [up or down].



One Finger Swipe (horizontal)

Adjust Menu Slider: Drag the slider to adjust the setting.

With a Chart View displayed on the screen, drag one finger across the screen to see more of the chart that is displayed off-screen.

With a 2D Sonar View displayed on the screen, drag one finger across the screen to see more of the sonar history.



Two Finger Swipe

With a view displayed on-screen, touch the screen with two fingers and swipe down to return to the Home screen.

Tap Functions



One Tap

Select [Open]: Tap to select [or open] a view, tool, widget, menu, or icon.

Activate the Cursor: Tap a position on the view once.



Two Taps

Tap the screen twice to zoom in on the current display.

Press and Hold Functions



Pinch

Zoom In: Touch the screen with two fingers and move them apart to zoom in on the display.

Zoom Out: Touch the screen with two fingers and bring them closer together to zoom out.



Press and Hold

Press and hold a position on the view with one finger to open the Cursor Menu.

Basic Touch Screen and Keypad Operations

Select (Open) a Tool, Widget, or View

Touch Screen

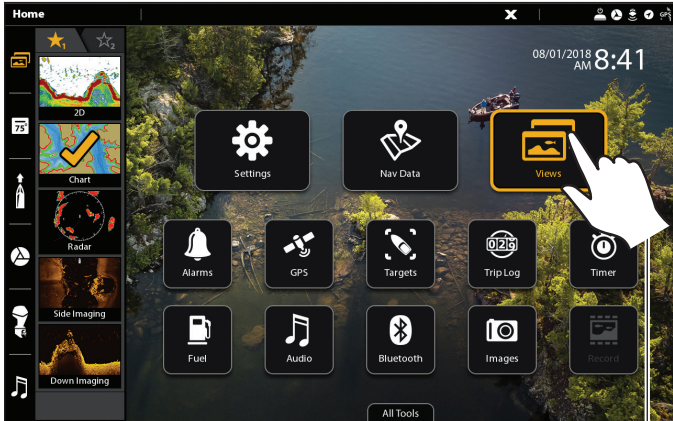

tap to open

Keypad

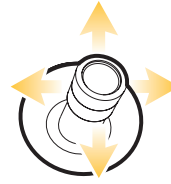

Select

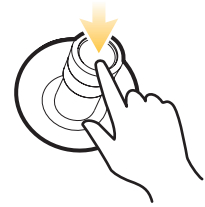

Open

Adjust a Menu Setting

Touch Screen

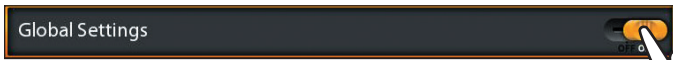

Tap



Press and Hold OR Slide

Keypad



Press

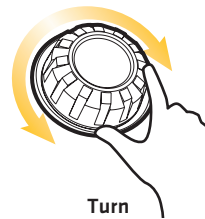

Turn

OR



Press and Hold

Close a Tool or Menu

Touch Screen

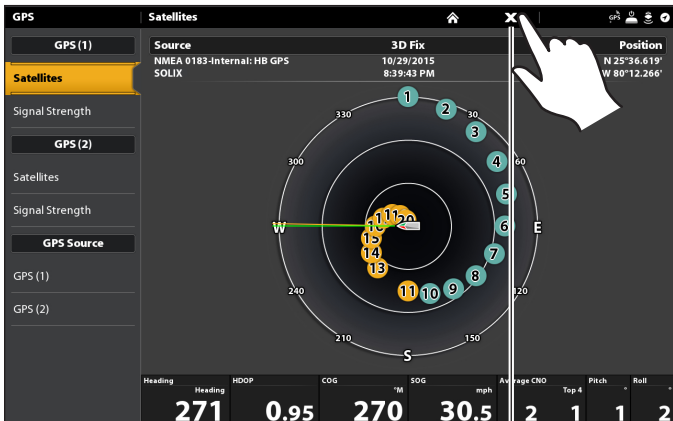

tap to close

Keypad

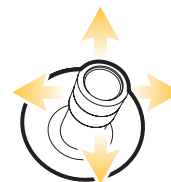

Select



Close

Open a View from the Views Tool

Touch Screen

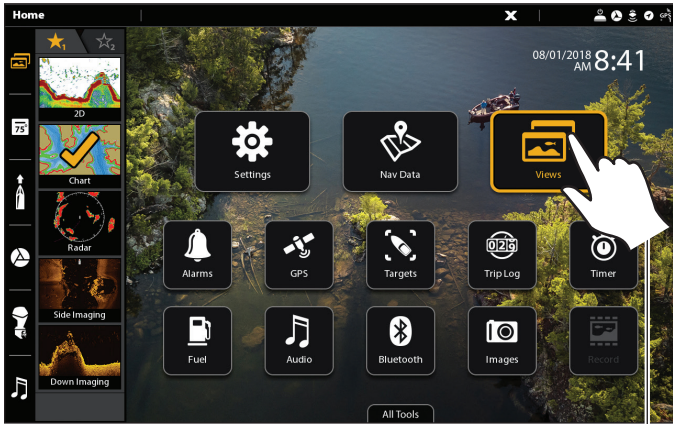

tap to open

Keypad

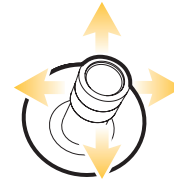

Select

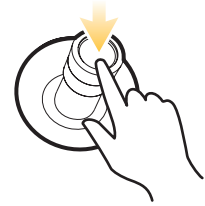

Display

Open a View from the Favorite Views Widget

Touch Screen

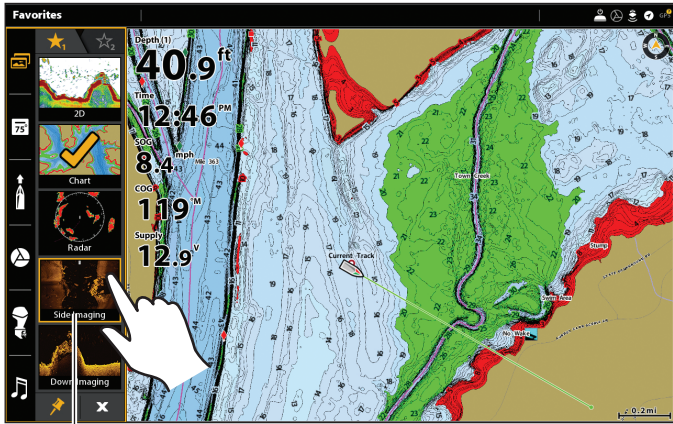

tap to open

Keypad

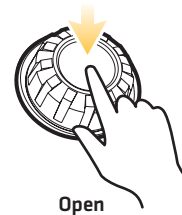

Open

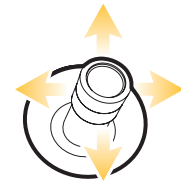

Select



Display

SD Card Slots

Your control head may be compatible with an SD or microSD card [separate purchase required]. Use it to update software, add detailed charts to your control head, import/export navigation data, and save sonar recordings and screen snapshots. Use the instructions in this section to install the card.

CAUTION! Before the control head software is updated or restored to system defaults, export your menu settings, radar settings, and navigation data [see **Update Software**].

WARNING! Do not leave the card slot cover open. The slot cover should always be closed to prevent water damage to the unit.

Insert an SD Card

The left slot is displayed as SD Card [1] in the menu system, and the right slot is displayed as SD Card [2].

1. Remove the SD card slot cover.
2. Position the SD card so that the label faces to the left.
3. Insert the card into the slot until it clicks into place.
4. Replace the slot cover so it is secure.
5. **Remove:** Press the card into the slot and then release it. The card will eject. Pull the card carefully from the slot.

Insert a microSD Card

The top slot is displayed as SD Card [1] in the menu system, and the bottom slot is displayed as SD Card [2].

1. Remove the microSD card slot cover.
2. Remove the microSD card from the microSD card adapter.
3. Position the microSD card so that the label faces the front of the control head and the card notches face down.
4. Insert the card into the slot until it clicks into place.
5. Replace the slot cover so it is secure.
6. **Remove:** Press the card into the slot and then release it. The card will eject. Pull the card carefully from the slot.

Load an SD Card

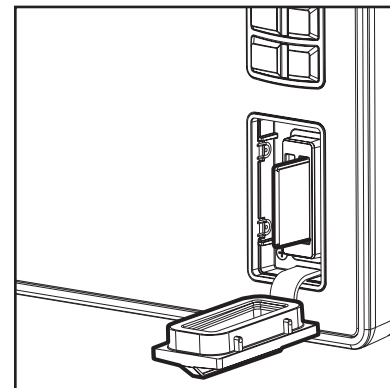

Vertical Slot:

Insert the SD card with the label facing left.

Horizontal Slot:

Insert the SD card with the label facing up.

POWER ON/OFF

Power On

1. Press the POWER key.
2. Select Start Normal Mode.
3. When the first view is displayed on the screen, the control head is ready for operation.

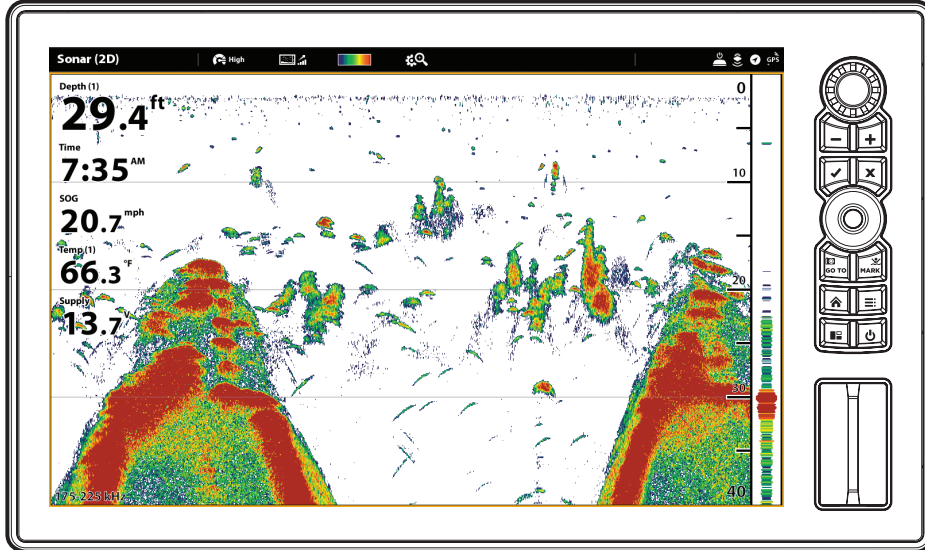

Use Standby Mode to Conserve Power

To conserve power while the control head is not in-use, start Standby mode from the Power X-Press Menu.

1. **Open the Power X-Press Menu:** Press the POWER key.
2. Select Standby.
3. **Turn off Standby Mode:** Press the POWER key.

Power Off

1. Tap the top, right corner of the status bar.

OR

Press the POWER key.

2. Select Power Off.



Additional Keypad Option

Press and hold the POWER key.

GETTING STARTED

The procedures in this section describe how to get started with your control head:

- review GPS reception
- check connected accessories and sensors
- start radar transmission
- pair your **Bluetooth®** wireless technology enabled mobile device [phone or tablet]
- set alarms

See the control head installation guide and the quick start guide included with your APEX or SOLIX control head to configure the unit for first time setup. Also, see **Installation Information** in this manual for control head configuration and network configuration details.

NOTE: When the APEX/SOLIX control head equipment and accessories are first installed, the Setup Guide provides the prompts to guide you through configuring the unit. The Setup Guide includes important steps to configure the control head with the equipment, including vessel dimensions, map source selection, and offset menus. See your control head installation guide to configure the unit for the first time.

The APEX Home Screen



The SOLIX Home Screen

Bluetooth notifications (with paired mobile phone)(from left to right): call notifications, text notifications, phone battery power percentage, and phone carrier signal strength.

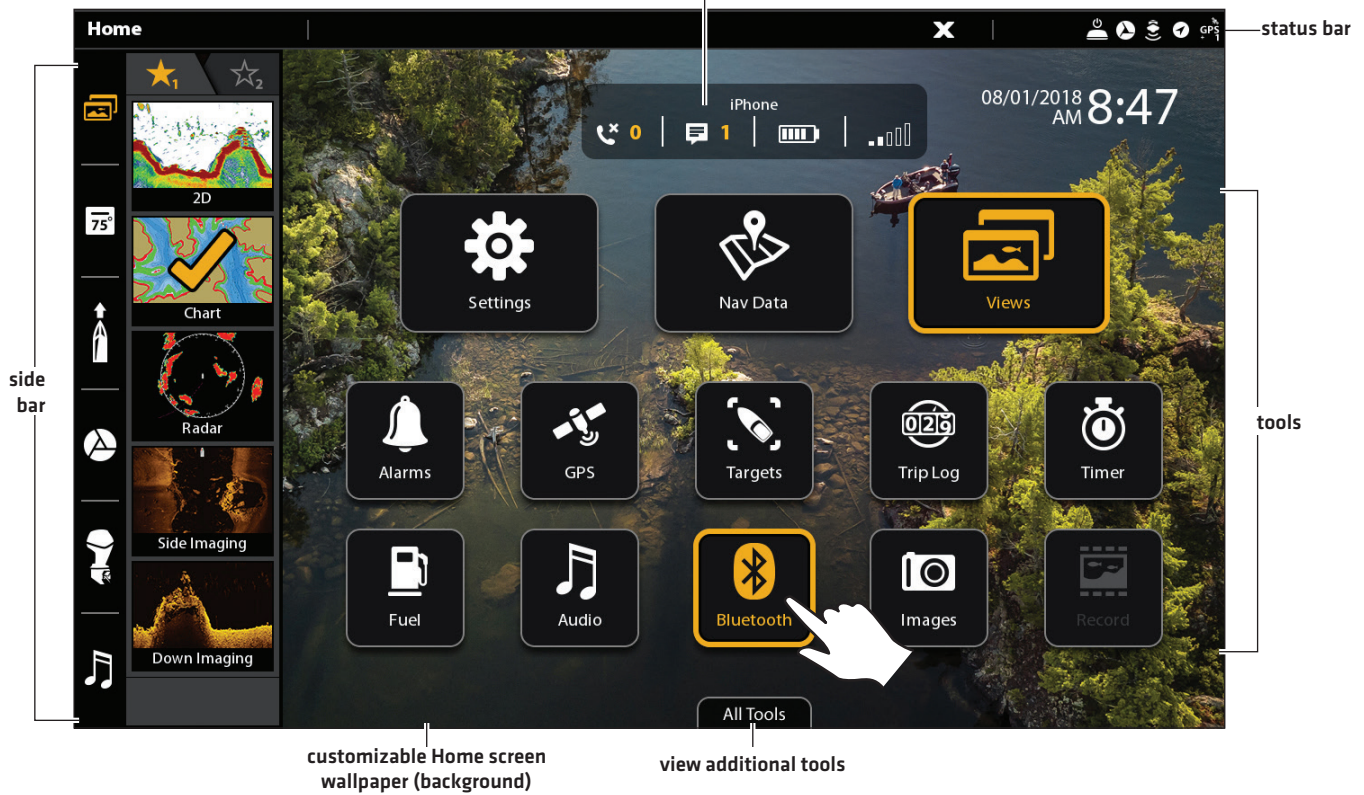

1 | Review GPS Reception

Use the GPS tool to check the GPS reception. The GPS tool provides two ways to view the satellites communicating with the GPS Receiver. **Yellow** indicates that the satellite is being used to determine your current position. **Teal** indicates that the satellite is being monitored but not used. The following data is also displayed:

- **Position** [latitude and longitude]
- **GPS Fix Type:** reported as No Fix, 2D Fix, 3D Fix, or Enhanced. An Enhanced fix has been augmented using information from WAAS, EGNOS, or MSAS. A 3D or Enhanced Fix is required for navigation.
- **HDOP (the Horizontal Dilution of Precision):** a GPS system parameter which depends on the current satellite configuration. HDOP is used to calculate the Estimated Position Error.

Open the GPS Tool

If there is more than one control head installed on the network, select the control head that is connected directly to the GPS receiver.

1. Press the HOME key.
2. Select the GPS tool.

Review Satellites and Signal Strength

1. Under GPS [1], select Satellites.
2. Under GPS [1], select Signal Strength.

GPS (1) and GPS (2) Sources

You can also manually change which GPS receiver is the selected source for GPS [1] or GPS [2]. To change the GPS sources, see *Set up your Humminbird Network*.

- **GPS [1]** provides position data, Speed over Ground (SOG), Course over Ground (COG), waypoints, routes, tracks, and navigation calculations to the control head.
- **GPS [2]** provides position data that is displayed in the GPS [2] data box.

GPS [1] Satellite Sky Chart

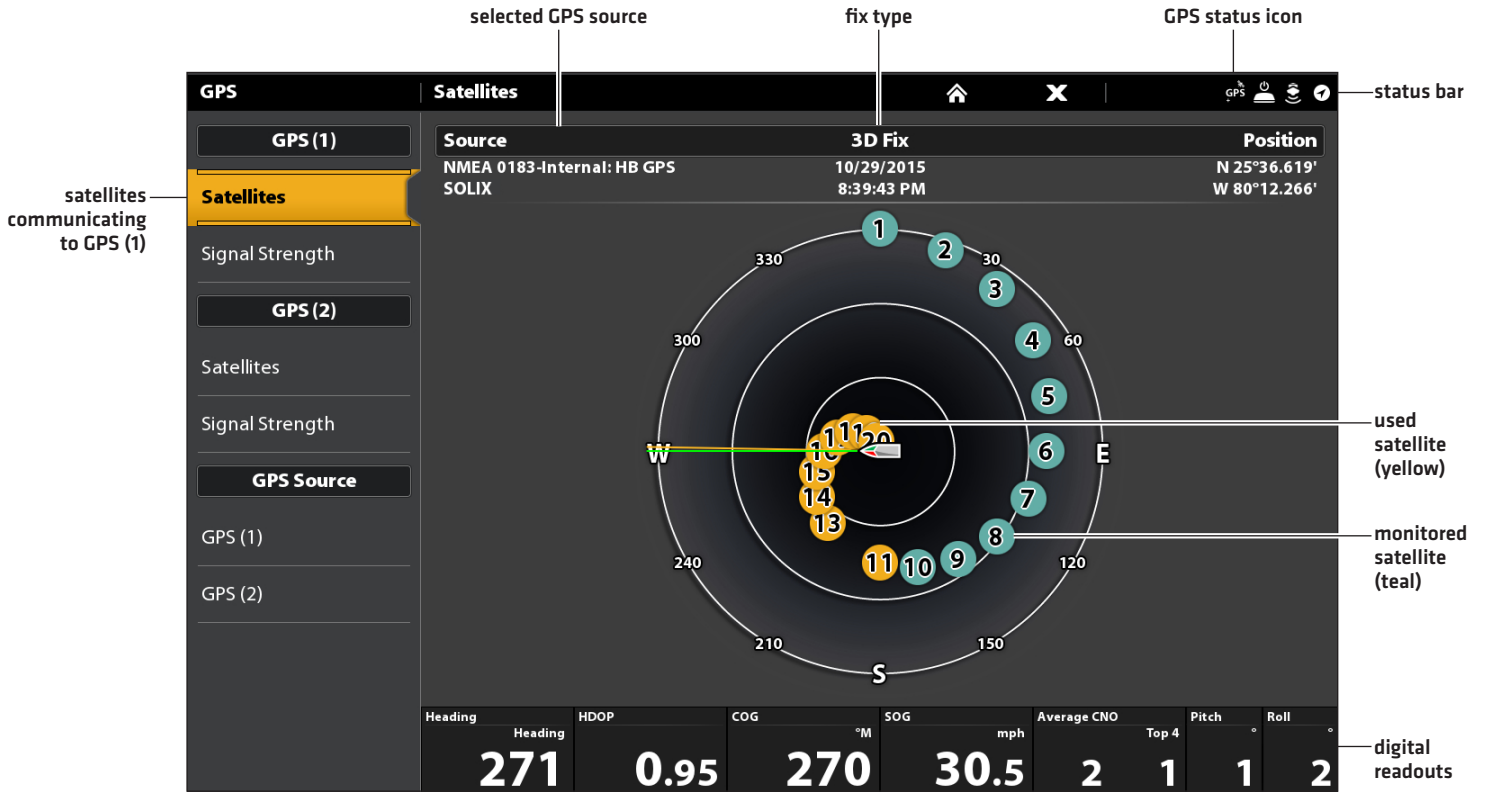

GPS (1) Satellites shows a sky chart and numerical data from the selected GPS receiver

Signal Strength (bar graph)

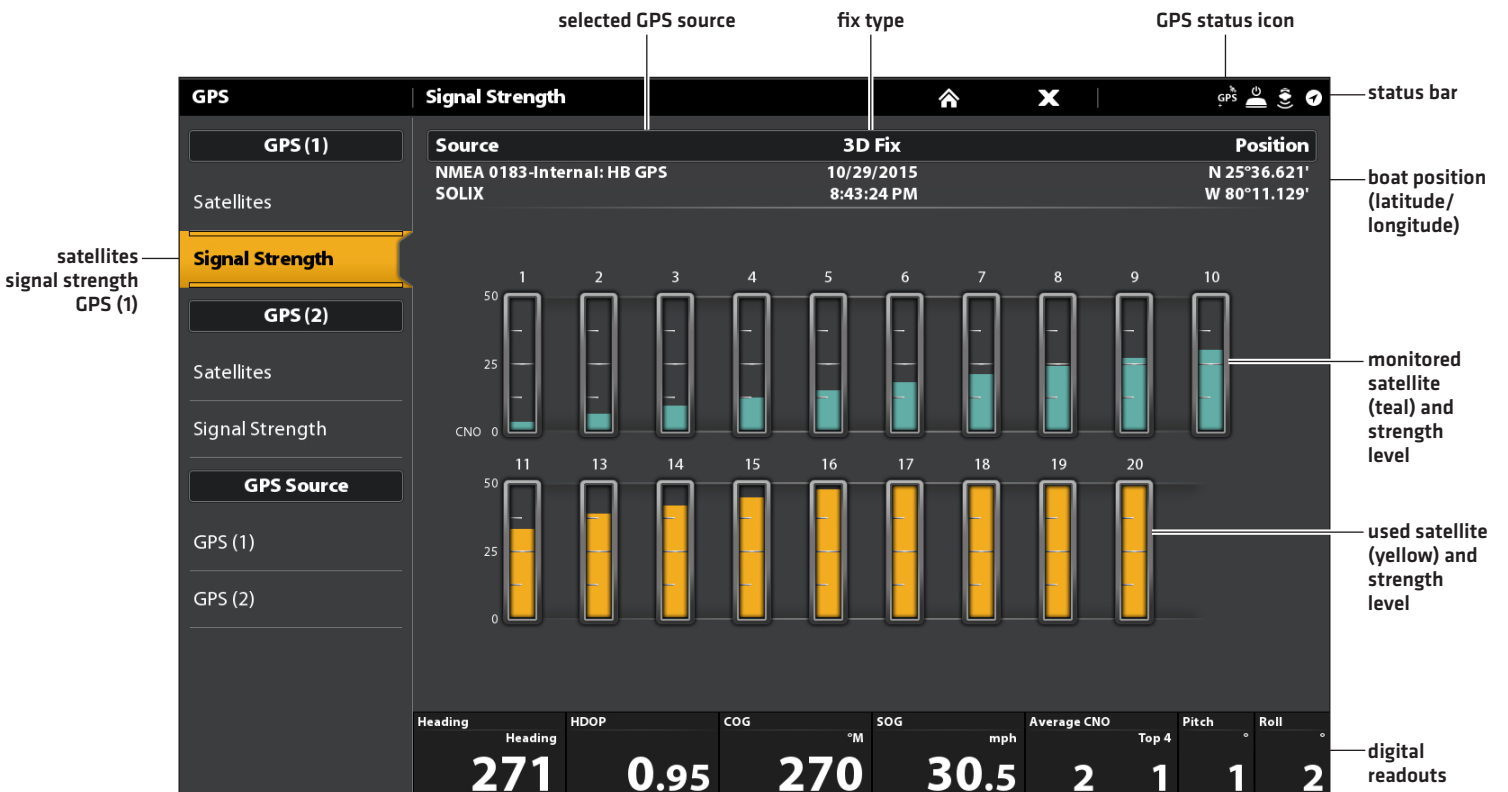

Signal Strength (GPS 1/GPS 2): displays vertical bar graphs indicating the satellite signal strengths with the respecting CNO (Carrier-to-Noise) value (0 to 60).

2 | Check Sensor Reception and Connections

If you've connected other separate-purchase equipment to the control head network, such as AIS, Compass/Heading Sensor, Radar, i-Pilot Link, 360 Imaging, and more, use these instructions to confirm the equipment is detected and communicating with the control head.

1. Press the HOME key.
2. Review the top, right corner of the status bar.



Detected and Active: If a sensor is active and transmitting/receiving, it will be white. See the table below.



Connected but not Detected or Active: If a sensor is not detected on the network, or not transmitting/receiving, it will be completely gray.



Connected but not Transmitting/Receiving: If a sensor is detected, but is not transmitting/receiving, the icon will be partially gray. In this illustration, the GPS receiver is detected, but it doesn't have a GPS fix. This feature will vary with the type of icon represented.

| Active Status Icon | Sensor | Icon Description |
|--------------------|-------------------------|--|
| | AIS | AIS is on and receiving targets. |
| | Compass | The selected compass/heading sensor is on and heading data is being received. |
| | GPS | The GPS receiver is detected and a GPS fix has been obtained. |
| | i-Pilot Link | i-Pilot Link is connected, enabled, and actively navigating. |
| | Bluetooth Talon | The Talon is connected and stowed. Download the Talon Accessory Manual from our Web site at humminbird.com for additional Talon status icons. |
| | Bluetooth Raptor | The Raptor is connected and stowed. Download the Raptor Accessory Manual from our Web site at humminbird.com for additional Raptor status icons. |
| | Radar | The selected radar source is detected and transmitting. |
| | 2D Sonar | The selected 2D sonar source is detected and pinging. |
| | MEGA 360 Imaging Sonar | The 360 Imaging transducer is pinging data. |
| | MEGA Live Imaging Sonar | The MEGA Live Imaging transducer is pinging data. |

3. If the sensors are active, your system is ready for use on the water.

For additional system status, select Home > Settings > Network > System Info.

If you have connected an accessory to the control head, and the icon is not displaying in the system status bar, check the installation of the accessory and the cable connection to the control head.

To change the NMEA 2000 network or multi-control head network sources, see *Set up a NMEA 2000 Network* and *Set up your Humminbird Network*.

3 | Start Radar Transmission [connected Radar source required]

For more information about Humminbird CHIRP Radar and Humminbird Radar, see *Radar Overview*.

 **WARNING!** The radar should be configured by a qualified radar technician after installation or equipment repair. See *Installation Information: Configure Humminbird Radar*.

1. Confirm the radar power source is turned on [breaker or switch].
2. Press the POWER key.
3. **Humminbird CHIRP Radar:** Select Radar > Standby. Press the POWER key again, and select Radar > Transmit.
Humminbird Radar: Select Radar Transmit. Tap the on/off button, or press the ENTER key, to turn it on.

4 | Pair a Bluetooth supported Mobile Device with the Control Head

Use the following instructions to pair a mobile device [phone or tablet] to the control head using Bluetooth wireless technology.

 **NOTE:** If you have a Bluetooth Talon or Raptor [separate purchases required], see the accessory operations manual for each product for pairing instructions. Operations manuals can be downloaded from our Web site at humminbird.com.

 **NOTE:** WiFi or cellular data must be enabled on your device.

Enable Bluetooth on your Device

1. Open the Settings menu on your device.
2. Select Bluetooth.
3. Select On.

Pair the Phone with the Control Head

1. Press the HOME key.
2. Select the Bluetooth tool.
3. Under Phone Bluetooth, select Settings.
4. Select Connect Phone.
5. Follow the on-screen prompts to complete the pairing process.
6. Check the Bluetooth menu on your phone. Tap the name of the control head on your phone.
7. Confirm the six digit confirmation code and tap Pair on your phone.

Upon successful pairing, the control head will be listed as connected under the phone's Bluetooth menu, and your phone name will be displayed on the Data Dashboard on APEX or the HOME screen on SOLIX.

8. **Reconnect:** The control head should automatically reconnect to your mobile device when in range. If it does not automatically reconnect, you can manually reconnect the control head by tapping on the name of the control head listed under My Devices [Apple iOS] or Previously Connected Devices [Google Android].

Pairing a Mobile Phone to the Control Head [SOLIX]

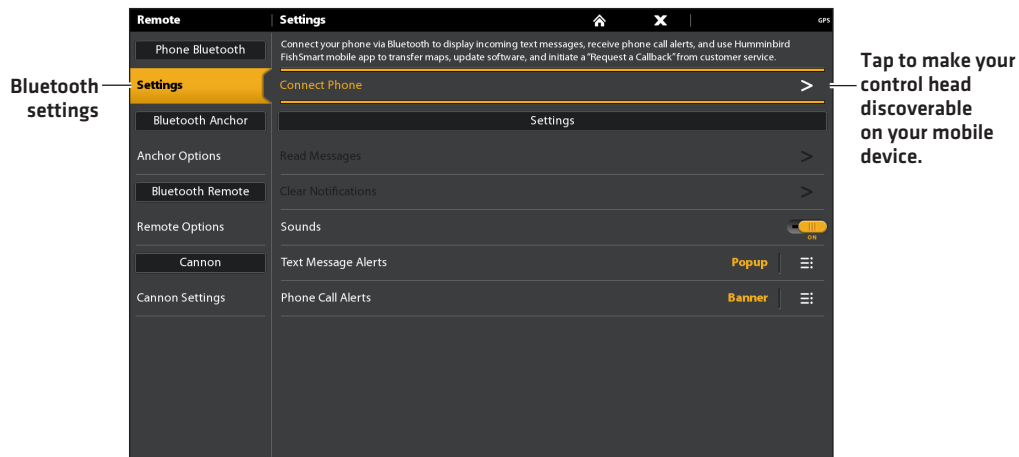

Change the Phone Bluetooth Notification Settings on the Control Head

Use the following instructions to select an alert format on the control head or turn off alerts.

1. Under the Phone Bluetooth menu, select Settings.



NOTE: In your phone Settings menu, confirm that Bluetooth is turned on and Show Notifications is turned on.

2. Select Text Message Alerts or Phone Call Alerts.
Tap to select an alert format. To turn off notifications, select off.
3. Turn Sounds On/Off: Select Sounds. Select on or off.

Change the Phone Bluetooth Notification Settings on the Phone

1. **Apple iOS:** Open the phone's Bluetooth menu, and next to the control head's name under My Devices, tap the information icon.
Google Android: Open the phone's Bluetooth menu, and next to the control head's name under Available Media Devices, tap Settings.
2. **Apple iOS:** Turn on Show Notifications.
Google Android: Turn on Share Messages.

Review Phone Bluetooth Notifications

APEX: View phone notifications on the Data Dashboard.

SOLIX: View phone notifications on the Home screen.

Mobile Phone Paired to the Control Head [APEX]

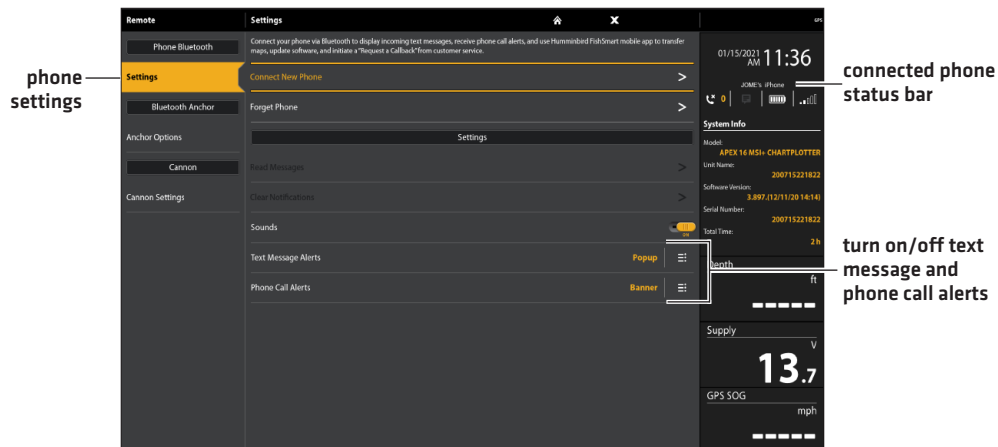

Forget Device

If you are having any issues with your connection, forget the device on both the phone and the control head and start the pair process over.

Forget Device on the Phone

1. **Apple iOS:** Open the phone's Bluetooth menu, and next to the control head's name under My Devices, tap the information icon.
Google Android: Open the phone's Bluetooth menu, and next to the control head's name under Available Media Devices, tap Settings.
2. **Apple iOS:** Tap Forget This Device.
Google Android: Tap Forget.

Forget Device on the Control Head

1. Under the Phone Bluetooth menu, select Settings.
2. Select Forget Phone.

5 | Set Alarms

When an alarm is turned on, an alert will sound or display on the control head to indicate the threshold has been exceeded.

1. Press the HOME key. Select Alarms.
2. Under Settings, select Alarms.
If the control head is connected to the Humminbird network, select **Local Alarms** [control head only] or **Networked Alarms** [alarms shared across control heads]. See **Set up your Humminbird Network** for more information.
3. Select an alarm category.
4. Select an alarm name.
5. **On/Off:** Tap the on/off button, or press the ENTER key, to turn on the alarm.
6. Adjust the alarm threshold.
Touch Screen: Press and hold the slider, or drag the slider.
Keypad: Press and hold the ENTER key, or turn the Rotary dial.
7. Repeat steps 3 through 6 for each alarm you want to set.

Setting an Alarm

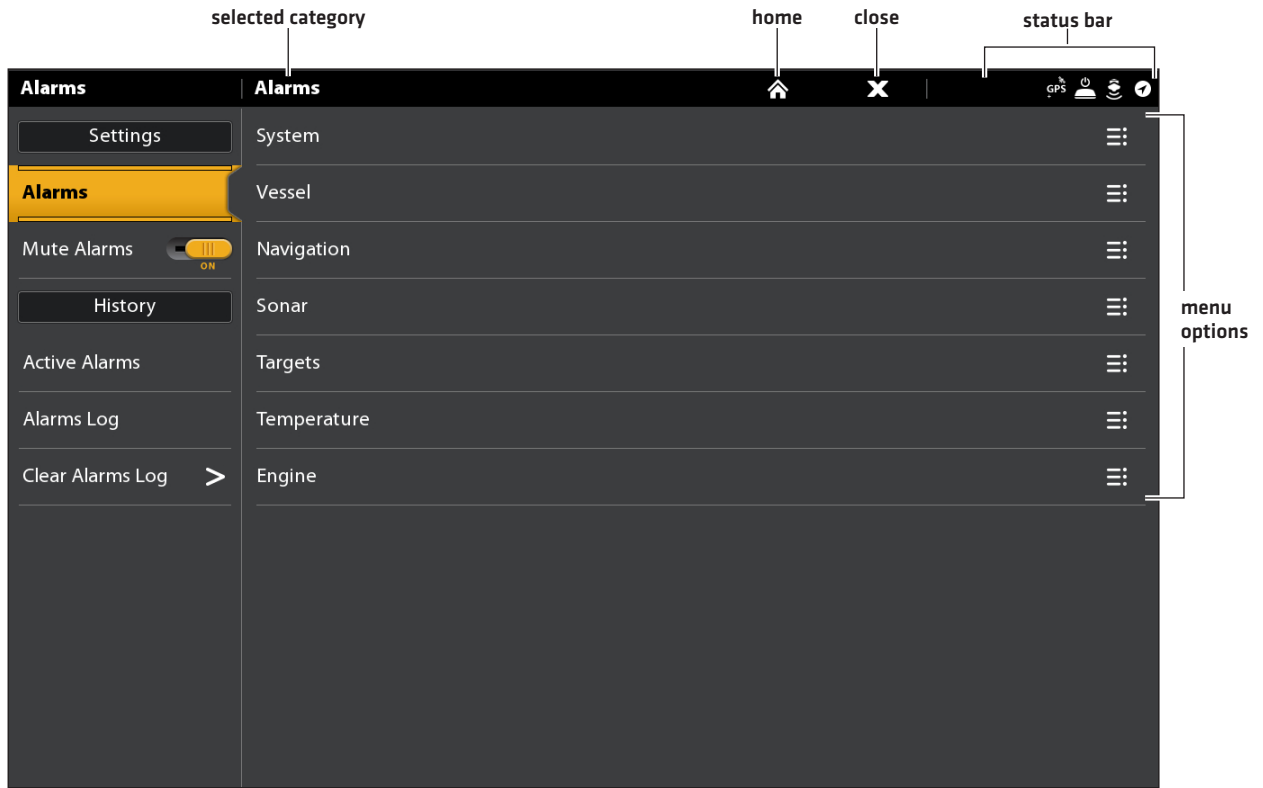

NOTE: See *The Menu System: Tips for Using the Status Bar* for more details.

The available alarms are determined by the connected equipment, so your control head may provide more or less options than the information shown here.

| | |
|-------------|--|
| System | Voltage, Lost Heading [compass/heading sensor required], etc. |
| Vessel | Drift Limit, SOG [Speed over Ground], STW [Speed through Water], etc. Also, see Views: Understand the Data Box Digital Readouts for more information. |
| Navigation | See Chart Overview: Navigation Alarms Overview for details. |
| Sonar | See Sonar Overview: Sonar Alarms for details. |
| Radar | See Radar Overview: Radar Alarms for details. |
| Temperature | Temp [High] or Temp [Low]. To change the Temperature sources, see Installation Information: Set up your Humminbird Network . |
| Engine | Low Fuel, Engine Temp, Oil Level, Coolant Level, Check Engine, etc. To change Engine and Fuel sources, see Installation Information: Set up a NMEA 2000 Network . |

Use the following menus to view any alarms that have been triggered:

Active Alarms: View current, active alarms.

Alarms Log: View previously occurring alarms.

Change System Settings

Your control head was configured during the installation setup. To change the system settings such as the backlight, key sounds, units of measurement, and the time and date format (including Daylight Saving Time), select Settings from the Home screen. See *Manage your Control Head* for more information.

1. Press the HOME key.
2. Select Settings.
3. Select General.



NOTE: To reconfigure the control head with the Setup Guide, select the Setup Guide tool from the Home screen.

Set up Sonar

Proceed to the *Sonar Overview* section.

Select the Map Source

Proceed to the *Chart Overview* section.

UPDATE SOFTWARE

As you build your Humminbird network, it is important to keep your control head and accessories software up to date. Accessories such as i-Pilot Link, 360 Imaging, and Ethernet Switches are updated through the APEX/SOLIX control heads.

You can update software using an SD or microSD card (depending on your APEX/SOLIX model) or using the built-in Bluetooth and the Humminbird FishSmart App.

Preparation: We recommend that you read this section completely before starting any software updates. Control heads take approximately 10 minutes to update, and each control head on the network must be updated individually. Accessories take approximately 3 minutes to update.

⚠ WARNING! Humminbird is not responsible for the loss of data files (waypoints, routes, tracks, groups, snapshots, recordings, etc.) that may occur due to direct or indirect damage to the unit's hardware or software. It is important to back up your control head's data files periodically. Data files should also be saved to your PC before restoring the unit's defaults or updating the software.

1 | Register Products

Register your Humminbird equipment so that you will receive the latest Humminbird news, including accessory compatibility and software update information.

1. Go to our Web site at humminbird.com. Select Support > Register your Product.
2. Follow the on-screen prompts to register your products.

2 | Back up Control Head Data

Before the control head software is updated or restored to system defaults, it is important to back up your control head data files (including navigation data and screen snapshots) and menu settings to an SD card.

Export Data and Menu Settings

Use the instructions in this section before you restore the control head defaults or update software.

1. Install the SD card into the control head card slot.
2. Press the HOME key.
3. Select the Files tool.
4. Under Export, select Nav Data.
5. Follow the on-screen prompts.
6. **Select a Save Location:** Save to the SD Card.
7. Repeat steps 4 and 5 to export Menu Settings and Radar Installation settings [if applicable to your installation].
8. **Networked Units:** Repeat the steps in this section on each control head.

📄 NOTE: If you want to use the data files and menu settings on your control head after it has been updated, you can import them from the Files tool.

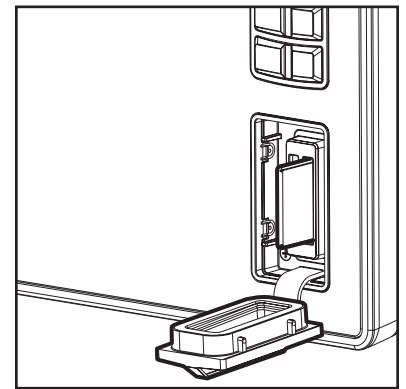

Vertical Slot:
Insert the SD card with the label facing left.

Horizontal Slot:
Insert the SD card with the label facing up.

Copy Internal Images

If you have screen snapshots saved to the control head, use the following instructions to copy them to an SD card.

1. Install the SD card into the control head card slot.
2. Press the HOME key.
3. Select the Images tool.
4. Under Source, select Internal.

5. Press and hold one of the screen snapshots.

OR

Use the Joystick to select a screen snapshot. Press the MENU key.

6. Select Copy All.
7. **Select a Save Location:** Save to the SD Card (left slot = SD Card 1, right slot = SD Card 2).
8. Repeat the steps in this section on each control head.

3 | Check the Current Software Version

It is helpful to review the software version number that is currently installed on the control head and each accessory.

APEX

1. Press the HOME key.
2. View the Software Version listed under System Info in the Data Dashboard.

SOLIX

1. Press the HOME key.
2. Select Setting > Network > Network Info.
3. The Network Info dialog box shows a section for each device connected to the network. Scroll to each section to note the software version number listed.

4 | Download Software Updates

1. Install the SD card into the PC card slot.
2. Go to humminbird.com, and click Support > Software Updates.
3. The available software updates are listed as **Downloads** under each product.
 - Under Downloads, click the file name. Confirm the file name is for your control head model.
 - Read the instructions in the dialog box and select Download.
 - Follow the on-screen prompts to save the software file to the SD card.
4. Repeat step 3 to download the software updates posted to each product.

5 | Update Control Head Software

Supplies: In addition to your Humminbird equipment, you will need a PC with Internet access and a blank SD or microSD card (depending on your control head model).

When you install the SD card with the software file, the control head will detect the update and provide an automatic prompt to install the software. You can follow the prompts or choose to install the software at a later time through the Files tool. It is important to review the following tips:

- **Automatic Restart:** The control head will restart during the software update process.
- **Multiple Control Heads:** If you have more than one control head on the network, go to each control head to install the latest software update. Control Head software updates cannot be updated through another networked unit.



WARNING! Before the control head software is updated or restored to system defaults, export your menu settings, radar settings, and navigation data. Copy your screen snapshots to an SD card. See **Register Products and Back up Control Head Data** for details.

Update Software Automatically

1. Press the POWER key. Follow the on-screen prompts to start normal mode on the control head.
2. Install the SD card with the software file(s) into the control head card slot.
3. A dialog box will display to start the software update.

To start the control head software update, select Install. When SUCCESS is displayed, the software update is finished. If you have accessories to update, proceed to **Update Accessories**. If you don't have any other software updates to install, power off the control head, and restart it.

OR

To update the software at a later time from the Files tool, select Cancel. If you select Cancel, see **Update Software from the Files Tool** in this section.

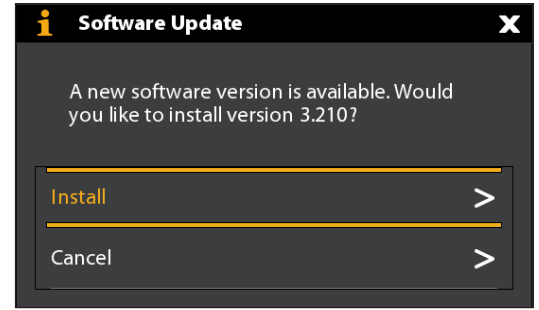

Update Software from the Files Tool

1. Install the SD card with the software file(s) into the control head card slot.
2. Press the HOME key.
3. Select the Files tool.
4. From the Software Update tab, scroll to This Unit.
5. Confirm that the most current version of software is selected from the list. Select Install Now.

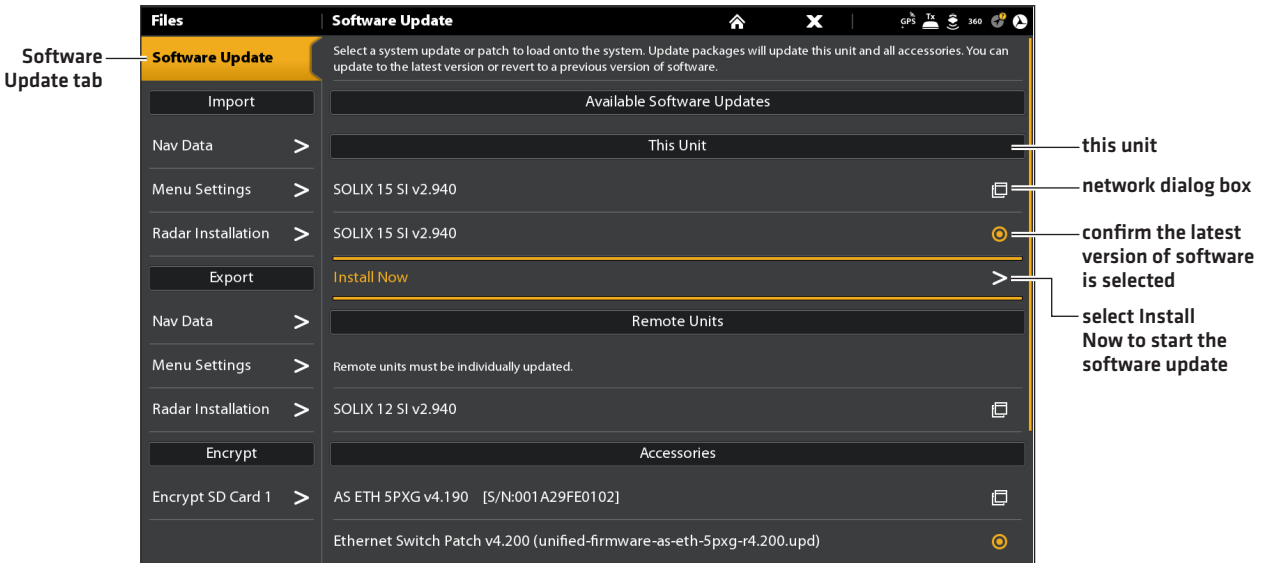

6. When SUCCESS is displayed, the software update is finished. If you have accessories to update, proceed to **Update Accessories**. If you don't have any other software updates to install, power off the control head, and restart it.

Update Software from the FishSmart App

You can use the FishSmart App to download and push software updates directly to your Humminbird control head or accessory.

 **NOTE:** You must first download the FishSmart App and pair your mobile device to your control head.

1. Open the FishSmart App on your mobile device.
2. Tap Networks + Updates.
3. In the My Network tab, tap Update next to the selected unit. The download progress is displayed on the screen.
4. Tap Transfer next to the selected unit once the download is complete.

5. Confirm the estimated transfer time.
6. Tap the checkbox to select where to upload the software update [internal storage, card slot 1, or card slot 2].
7. Tap Transfer. The upload progress is displayed under the selected unit in the My Network screen in FishSmart and in the System Status view on the control head.
8. Follow the on-screen prompts on the control head to complete the software installation.

6 | Update Accessories

Accessory software is updated from the Files tool, and the process is similar to updating the control head software. It is important to review the following tips:

- Update the control head and accessories in the order they appear on the software update list in the Files Tool. **Sonar Black Boxes (SM3000)** and **Ethernet Switches** must be updated individually on the software update list.
- If an accessory is not displayed on the list, confirm it is detected on the network [Settings > Network > Network Info]. Also, confirm the cable connections are secure.
- You might notice that the control head will restart during the software update. This is part of the update process.
- The **i-Pilot Link** has separate software updates for the controller and remote. After the software is updated on the control head, you must go to the remote and initiate the download of the remote software to the remote itself. See your i-Pilot Link manual for details.

WARNING! Before the control head software is updated or restored to system defaults, export your menu settings, radar settings, and navigation data. Copy your screen snapshots to an SD card. See **Register Products and Back up Control Head Data** for details.

Update Accessories from the Files Tool

1. Install the SD card with the software file[s] into the control head card slot.
2. Press the HOME key. Select the Files tool.
3. From the Software Update tab, scroll to the first accessory in the list.
4. Confirm that the most current version of software is selected from the list. Select Install Now.

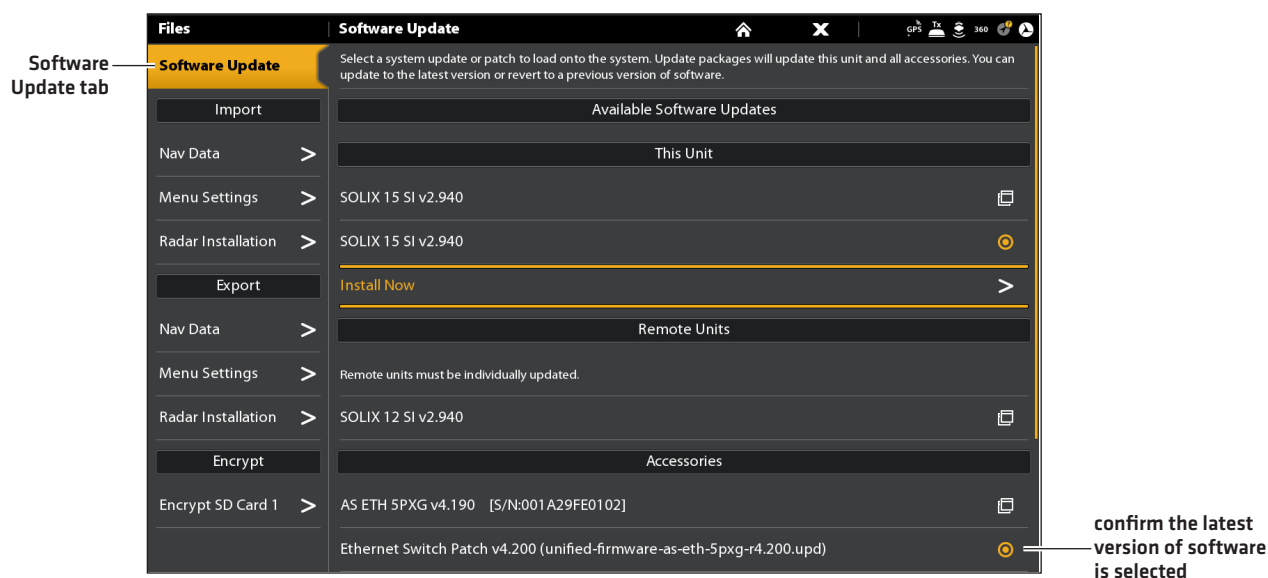

5. When the software update is finished, scroll to the next accessory update in the list [if applicable], and repeat step 4.
6. **Entire System Restart:** After all software has been updated, power off all control heads and connected equipment. Wait 10 seconds, and then power on all equipment.

THE HOME SCREEN

The Home screen is the main control center for your control head. Use the Home screen to access the control head settings, navigation data, views, alarms, and other tools.

- The tools, views, and side bar widgets available on the Home screen are determined by the equipment attached to the control head network.
- The Home screen wallpaper (background) can be customized using the Images tool.
- Pair your Bluetooth capable control head and mobile device to receive text message and phone call alerts on your Home screen.
- The APEX Home screen and tool menus includes an additional Data Dashboard that displays your connected phone, control head system information and standard data box readouts.

Open the Home Screen

Touch Screen

1. With a view displayed on-screen, touch the screen with two fingers and swipe down.

Keypad

1. Press the HOME key.

The APEX Home Screen



Swipe down to open from any view

OR



Press the HOME key

The SOLIX Home Screen

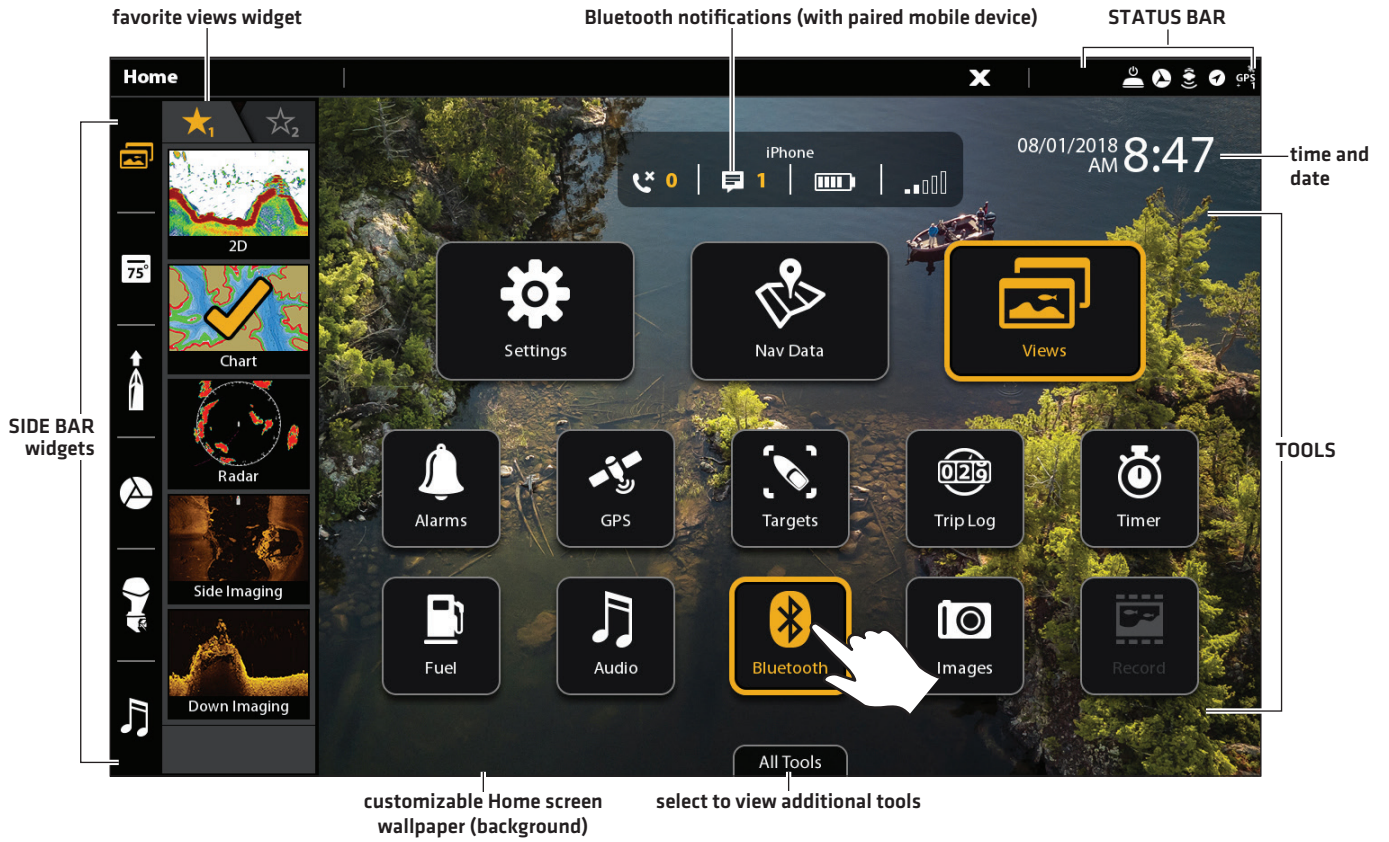

Swipe down to open from any view

OR



Press the HOME key

Navigate the Home Screen

See the instructions and screenshot below to better understand the Home screen layout.

Touch Screen

Open a Tool: Tap the tool icon.

Open a Widget: Tap the widget icon [in the side bar].

View Additional Tools: Tap All Tools [SOLIX only].

Close [return to the previous view]: Tap the X icon in the status bar.

Keypad

Select [Open]: Use the Joystick to select a menu, tool, or widget. Press the ENTER key to open it.

Open a Widget: Press the PANE key. Use the Joystick to select the widget icon and press the ENTER key to open it.

View Additional Tools: Use the Joystick to select All Tools. Press the ENTER key. [SOLIX only]

Close [return to the previous view]: Press the EXIT key.

Opening a Tool (SOLIX)

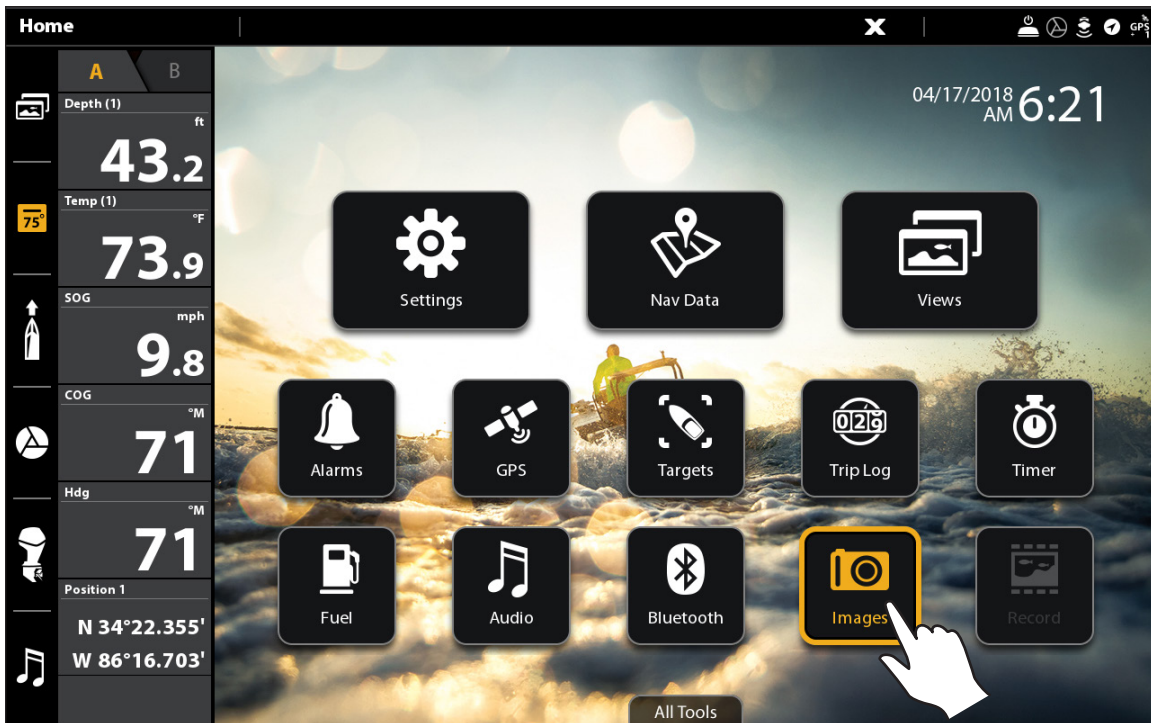

Tap to Select (Open)

OR

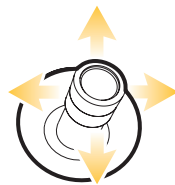

Select



Open

Tools

Tools allow you to manage the control head network operations and saved data. When you connect an accessory to the control head, a related tool may also be displayed.

| | |
|------------------------|---|
| <p>Settings</p> | <p>Select Settings to change general system settings such as the backlight, units of measurement, and the time and date format. You can also use this menu to change the main settings for each application [Sonar, Chart, Radar, etc.]. See each related section of this manual for details.</p> |
| <p>Nav Data</p> | <p>Select Nav Data to manage your saved waypoints, routes, tracks, and groups. You can create new navigation data from this screen, edit your saved navigation data, or start navigation [see Manage your Navigation Data].</p> <p>Required Equipment: GPS receiver [internal or external]</p> |
| <p>Views</p> | <p>Select Views to access the complete set of views available on your control head. You can edit views, create your own views, and save your favorite views. See Views for more information.</p> |
| <p>Alarms</p> | <p>Select Alarms to view the alarm log, mute alarm sounds, and set the alarms for the individual applications. To set up individual alarms for navigation, sonar, radar, AIS, etc., see each related section of this manual for details. For example, for radar alarm settings, see Radar Alarms.</p> |
| <p>GPS</p> | <p>Select GPS to review the signal strength of the GPS receivers [“sensors”] connected to the system. The tool shows the satellites in the area, the positions, and the signal strength for each one. You can also designate a primary and secondary GPS source from this tool. See Getting Started, Installation Information, and Set up your Humminbird Network.</p> <p>Required Equipment: GPS receiver [internal or external]</p> |
| <p>Targets</p> | <p>Select Targets to manage AIS and MARPA targets. See AIS and MARPA for more information.</p> <p>Required Equipment: AIS or Radar, GPS receiver [internal or external], and compass/heading sensor</p> |
| <p>Trip Log</p> | <p>Select Trip Log to display Speed over Ground [SOG], timer for elapsed time, distance traveled since last reset, average speed, and trip fuel. You can also reset the trip log to zero and review trend data from this tool.</p> <p>Required Equipment: GPS receiver [internal or external]</p> |
| <p>Timer</p> | <p>Select Timer to set an alarm clock for a selected time of day, use the countdown timer, or use the stopwatch. You can set more than one alarm clock.</p> |
| <p>Fuel</p> | <p>Select Fuel to review the fuel log for NMEA 2000 fuel sensors connected to the network. This tool provides refuel alerts and displays the fuel level in graphical form. See Set up a NMEA 2000 Network for details.</p> <p>Required Equipment: NMEA 2000 tank sensor and/or fuel flow rate sensor</p> |
| <p>Audio</p> | <p>Select Audio to listen to AM/FM radio or audio files saved to a USB stick, iPod, etc.</p> <p>Required Equipment: compatible audio system</p> |

| | |
|-------------|---|
| Bluetooth | <p>Select Bluetooth to pair your mobile phone and/or Bluetooth wireless remote (separate purchase required) to the control head. You can also assign key functions for the Bluetooth remote from this tool. See your installation guide for details. To pair your mobile phone to the control head, see Getting Started.</p> <p>Required Equipment: mobile phone [with Bluetooth], Bluetooth remote</p> |
| Images | <p>Select Images to manage your screen snapshots. When a screen snapshot is taken, a waypoint can also be saved at the current position. You can also choose to save the image on the control head or to an SD or microSD card. Also, screen snapshots and pictures from your camera's SD card (JPG Files) can be displayed as the Home screen wallpaper and in a slideshow from this tool. See Getting Started and Images Tool for more information.</p> |
| Record | <p>Select Record to start a sonar recording or select a save location. You can also watch a sonar recording from the perspective of a 2D, SI, or DI View, depending on the capabilities of your model. See Sonar Recording for more information.</p> <p>Required Equipment: transducer, black box sonar</p> |
| Sun + Moon | <p>Select Sun + Moon to review the sunrise and sunset for today or the date you select. The Moon data provides the rise and set of the moon and moon phases.</p> <p>Required Map Source: Navionics or CoastMaster VX.</p> |
| WiFi | <p>Turn on personal hotspot, and set network name and password.</p> |
| Files | <p>Select Files to update the software for the control head or connected accessories. You can also import and export navigation data from this tool, and you can import and export menu settings. Radar installation settings can be managed from this tool, but only authorized radar technicians should use this menu. See the following sections: Manage your Navigation Data and Manage your Control Head.</p> <p>Required Equipment: SD or microSD card (depending on your control head model)</p> |
| Setup Guide | <p>Select Setup Guide, and the control head will guide you through the basic configuration settings for your control head, including units of measurement, language, transducer source, map source, and vessel settings. See your installation guide for details. To change the settings after setup, select Home > Settings.</p> |
| Tides | <p>Select Tides to review information for the nearest tide station to your present position. The tool includes the position of the station and the times of the high and low tides for today's date. A tide graph is also displayed showing the rise and fall of the tides for the 24 hour time period encompassing the date. You can also search data for a selected date.</p> <p>Required Map Source: Navionics or CoastMaster VX.</p> |
| Currents | <p>Select Currents to review information for the nearest current station to your present position. Two graphs are also presented that show the time, direction, and flow speed of the current changes for the 24 hour time period of today's date. You can also search data for a selected date.</p> <p>Required Map Source: Navionics or CoastMaster VX.</p> |

Side Bar Widgets

The side bar includes widgets that allow you to quickly access your favorite views, data bars, and digital remotes for networked accessories, like i-Pilot Link, Talon and Raptor.

The side bar is set to always display on the Home screen, but it can be hidden in other views. See *Edit the On-Screen View: Turn the Side Bar On/Off*.

Opening a Widget



Tap to Select (Open)

OR



Select the Side Bar

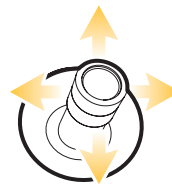

Select a Widget













Open

Available Side Bar Widgets

When you connect an accessory to the control head, a related widget may also be displayed in the side bar.

If you have connected an accessory to the control head, and the icon is not displaying in the system status bar, check the installation of the accessory and the cable connection to the control head.

| Widget Icon | Name | Widget Function |
|---|---------------------|--|
|  | Favorite Views | Allows you to create a list of your favorite views. There are two tabs, which allow you save up to 10 views. Use the widget to quickly display your favorite views [see Views]. |
|  | Data Bar | Displays the standard Data Bar with data box readouts. There are two tabs and each data box can be customized [see Views: Understand the Data Box Digital Readouts]. |
|  | Navigation Data Bar | Displays the Nav [Navigation] Data Bar with digital readout boxes for navigation. There are two tabs and each data box can be customized [see Views: Understand the Data Box Digital Readouts]. *With a connected i-Pilot Link, this selection will display the i-Pilot Link Navigation Data Bar. |
|  | i-Pilot Link* | Displays the i-Pilot Link digital remote. |
|  | Talon* | Displays the Talon digital remote, which includes quick access menus to deploy and retract the Talon, change the anchor mode, turn the work light on/off, etc. |
|  | Raptor* | Displays the Raptor digital remote, which includes quick access menus to deploy and retract the Raptor, change the anchor mode, change the speed, etc. |
|  | Cannon* | Displays the Cannon digital remote, which includes quick access menus to select the active downrigger, select depth presets, change the cycle mode, etc. |
|  | Digital Switching* | Displays the digital switch panel for your boat. Use this widget to quickly access settings for your boat's electrical and connected systems, such as lights, fans, horns, bilge, etc. See our Web site for compatibility information. |
|  | Engine Data* | Displays engine data from the connected NMEA 2000 network. Some data boxes include built-in submenus to view additional data. |
|  | Audio* | Displays the audio settings for a connected audio accessory. |

*separate purchase accessory

Status Bar

The status bar is located at the top of the screen. It changes to match the on-screen view and operation mode.

In the following illustration, the information in the status bar corresponds with the Chart View displayed on-screen. You can tap the icon in the status bar to open a menu, return to the Home screen, close a menu, or make a selection. You can also use the corresponding keys.

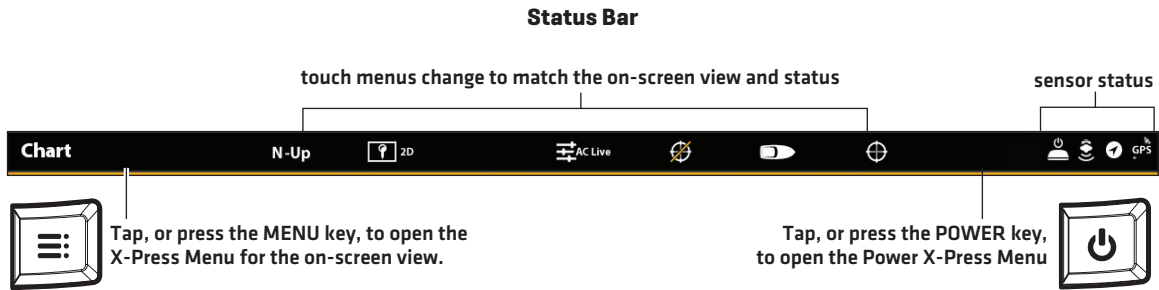
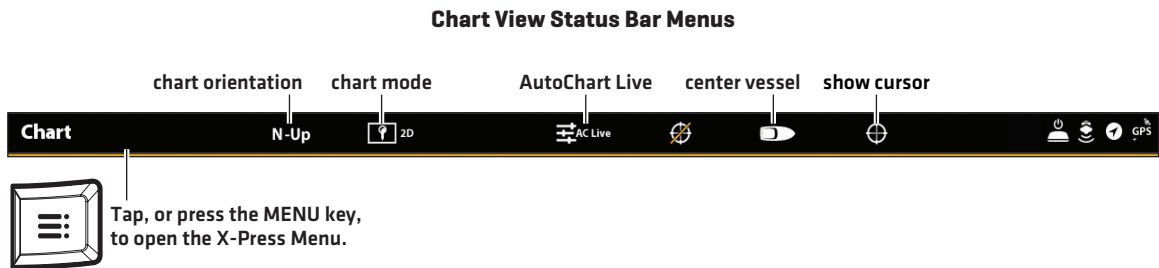
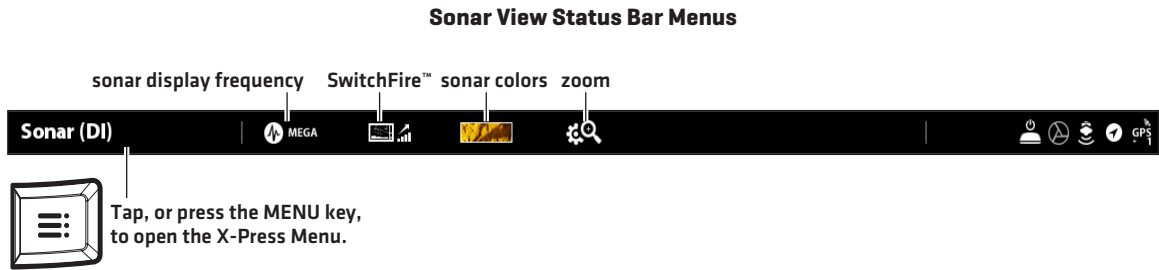

Chart View Status Bar Menus



Sonar View Status Bar Menus



Wallpaper

The background display, or wallpaper, for your Home screen can be customized. Choose from the existing selection of Humminbird wallpaper images or from your own saved images (on the control head or uploaded from an SD or microSD card).

Set the Home Screen Wallpaper:

1. Press the HOME key.
2. Select Images.
3. Under Wallpaper, select Images. Tap an image to set it as the Home screen wallpaper.

OR

Select your Saved Image: Under Source, select Internal, SD Card [1], or SD Card [2]. Use the Joystick to select the image and press the MENU key. Select Set As Wallpaper and press the ENTER key.

Setting the Home Screen Wallpaper

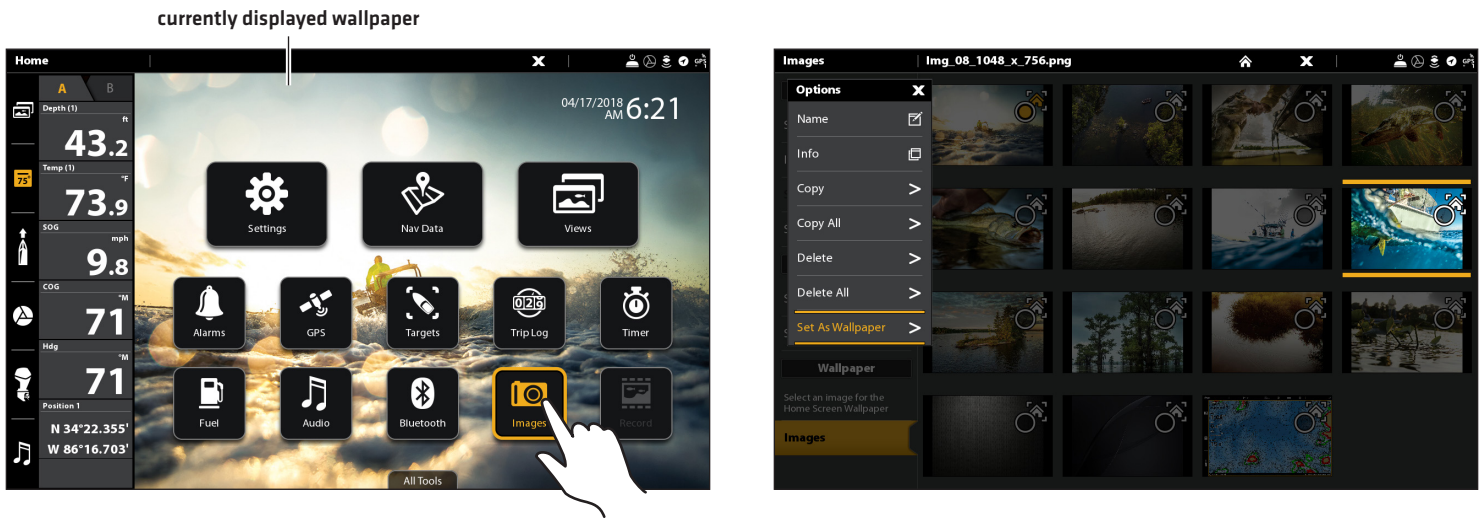

Tap to Select (Open)

OR

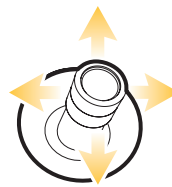

Select



Open

THE MENU SYSTEM

The APEX/SOLIX provides menu options that change with the application, on-screen view, and the operations mode.

Open Settings

The Settings tool provides main menu settings for the control head.

1. Press the HOME key.
2. Tap Settings.

OR

Use the Joystick to select Settings. Press the ENTER key.

Selecting Settings



Navigation Main Menu

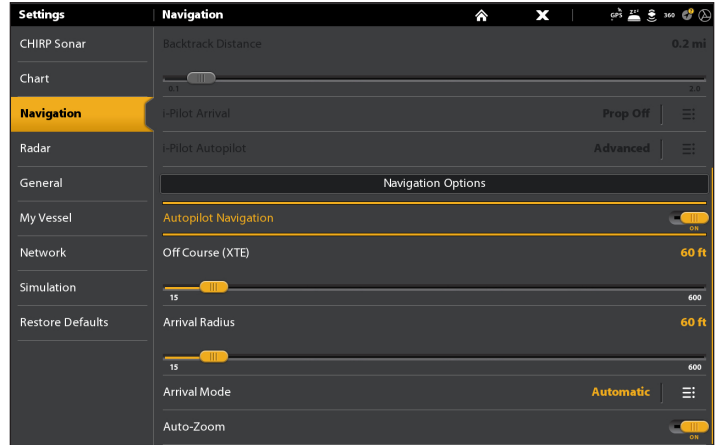

Tap Settings

OR

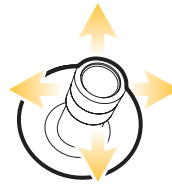

Select Settings



Open



Additional Keypad Option

With a view displayed on-screen, press the MENU key twice, or press and hold the MENU key.

Open an X-Press Menu

The X-Press Menu displays menu options for the on-screen view and operation mode (such as navigation). In a multi-pane view, the X-Press Menu options are determined by which pane is selected. See **Views** for more information.

Open an X-Press Menu

1. With a view displayed on-screen, tap the view name in the status bar.

OR

Press the MENU key.

Open an X-Press Menu in a Multi-Pane View

1. With a Multi-Pane View displayed on-screen, tap a pane.

OR

Press the PANE key to select a pane.

2. Tap the pane name in the status bar, or press the MENU key.

Opening an X-Press Menu for a Selected Pane

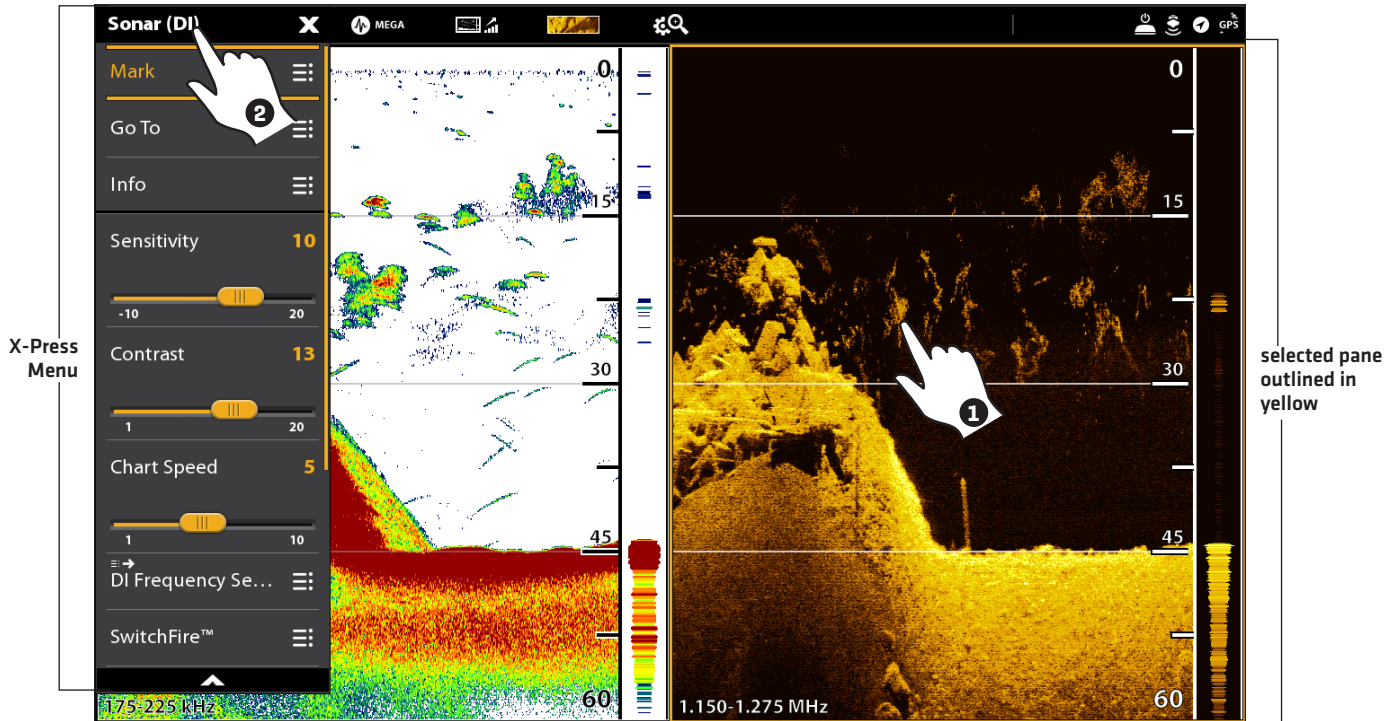

Tap to Select a Pane
and the Menu

OR



Press to Select a Pane



Press the MENU key

Change a Menu or Start an Action

Use the following instructions to change a menu setting or start an action through the menu system.

1. Tap a menu category, or use the Joystick to select it.
2. Tap a menu option, or use the Joystick to select it.
3. Adjust the setting or start an action using the touch screen or keys. See *Tips for Changing a Menu*.

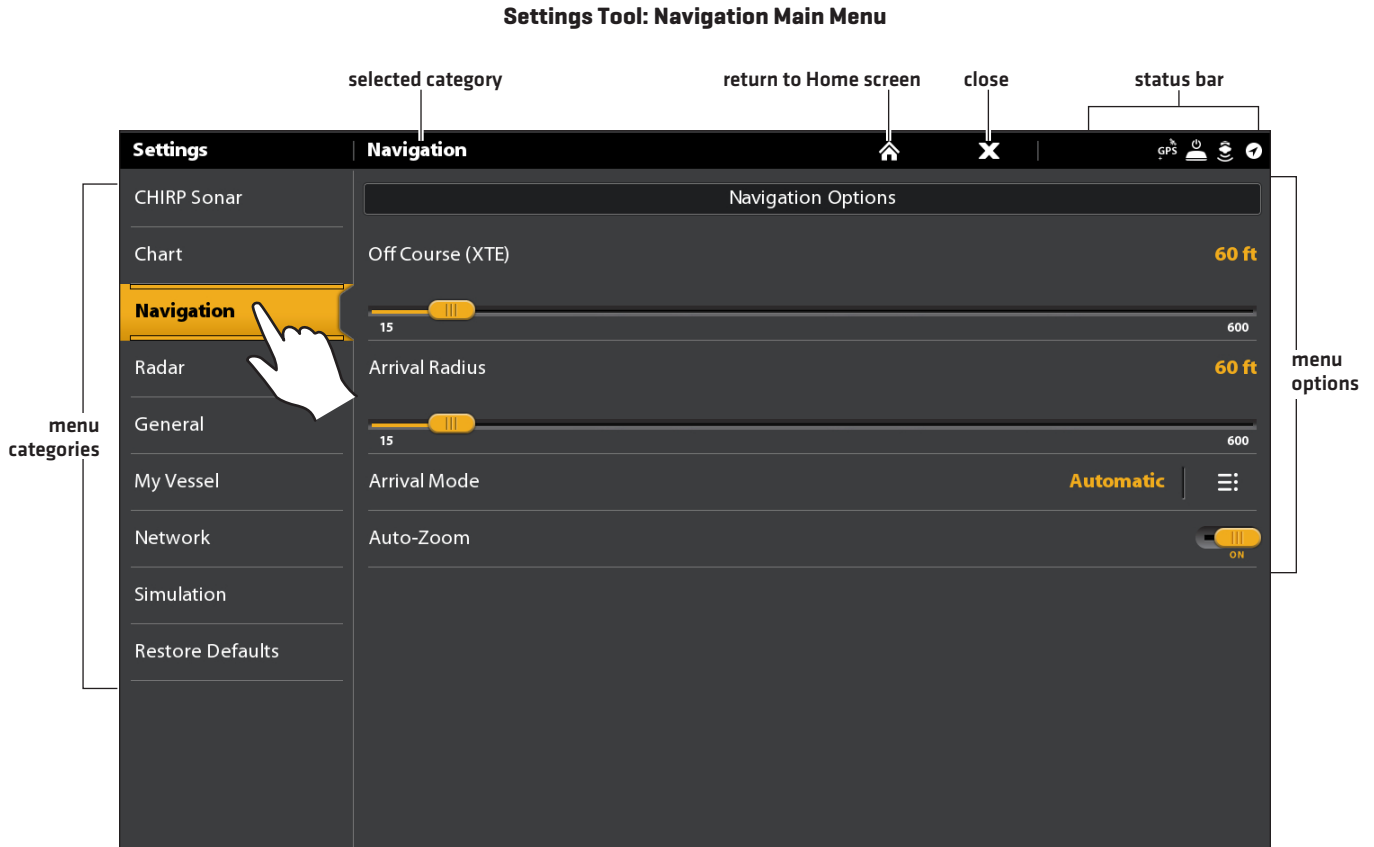

Tap to Select

OR

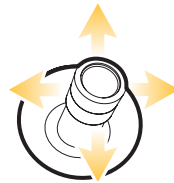

Select



Open

Tips for Changing a Menu

This section describes the different types of menus in the menu system and how to change them using the touch screen or keypad.

Action (>)

Touch Screen

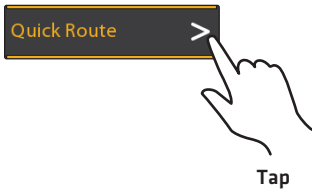

Keypad



Press

On/Off Button

Touch Screen



Keypad



Press

Slider

Touch Screen

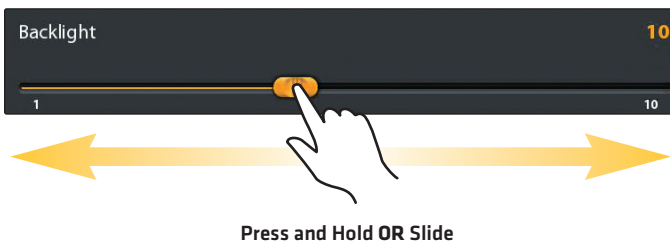

Keypad



Turn

OR



Press and Hold

You can also use the joystick to make selections.

Pick List or Check Box

Touch Screen

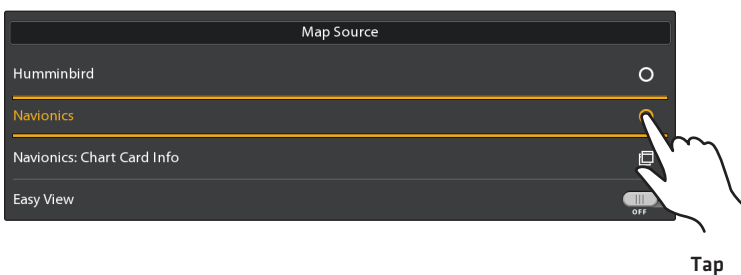

Keypad



Press

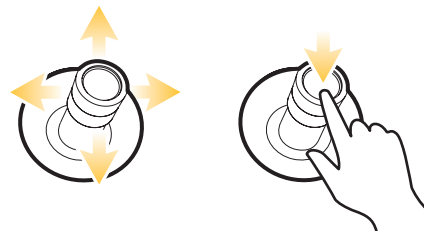

You can also use the joystick to make selections.

Tips for Using the On-Screen Keyboard

Use the on-screen keyboard to rename the control head in the network, edit your navigation data, and more.



Tap to Select a Character

OR

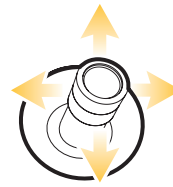

Highlight a Character

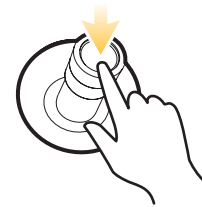

Press to Select the Character

Close a Menu

When you close a menu, your settings are saved until you change them again or until the control head defaults are restored.

1. **Back:** Tap the Back icon  to close the current menu and go back one level in the menu system.

OR

Press the EXIT key.

2. **Close:** Tap the X icon .

OR

Press the EXIT key. To close several menus at once, press and hold the EXIT key.



NOTE: The X icon is displayed in the status bar or at the top of a menu. The location will vary with the item displayed on the screen.

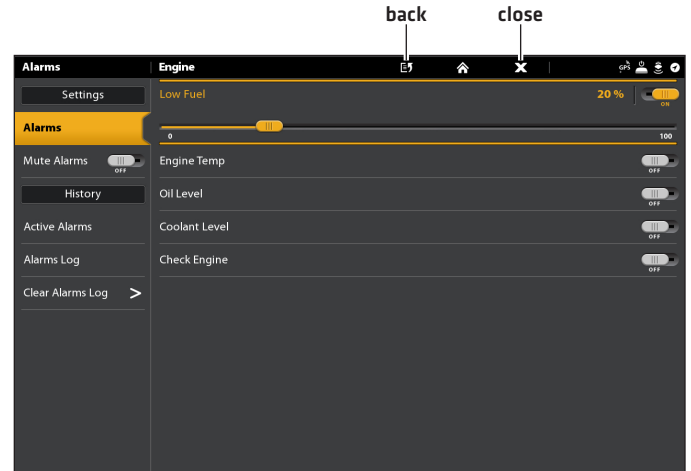

Change the User Mode

The APEX/SOLIX control head is automatically set to Angler Mode (recommended), which is configured with the best settings for a wide range of fishing conditions. To access in-depth customization menu options, set the user mode to Custom.

 **NOTE:** Export your menu settings and radar settings to an SD or microSD card before changing settings in Custom mode.

Change the User Mode

1. Press the HOME key.
2. Tap Settings.

OR

Use the Joystick to select Settings. Press the ENTER key.

3. Select General.
4. Under User Mode, select Angler or Custom.

VIEWS

There are many options to display data on-screen, and the data can be displayed in a variety of ways. You can open a view from the Views tool or from the Favorite Views widget (in the side bar). You can also create a new view, edit views, and customize your favorite views list.

Display a View from the Views Tool

The Views tool includes the complete database of available views for your control head. Use the Views tool to create a new view and edit a view.

1. Press the HOME key.
2. Select the Views tool.
3. Select a Group. To see all available views, select All.
4. Tap the View.

OR

Use the Joystick to select a view. Press the ENTER key to display it on-screen.

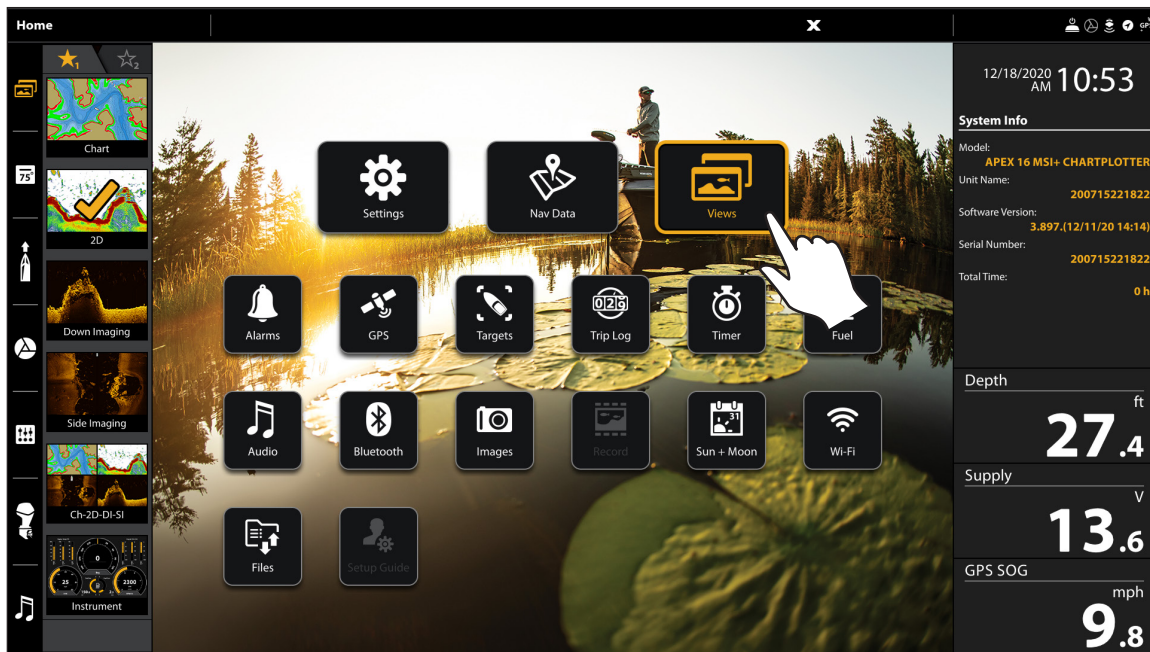

Tap to Select

OR

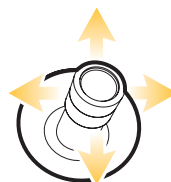

Select



Open

Views Tool

selected group

star = favorite

return to Home screen

close

status bar

Views

All

Groups

All

Favorites

Sonar

Chart

Radar

Instrument

Options

New View

groups

Options: select to create a new view

available views



Tap to Select

OR

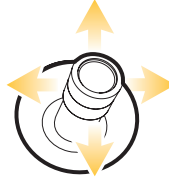

Select



Open

Display a View from the Favorite Views Widget

Touch Screen

1. Tap the views widget icon in the side bar.
2. Tap a view to display.

Keypad

1. Press the Rotary dial.
2. Use the Joystick to select a view to display. Press the ENTER key.

Opening a View from the Favorite Views Widget

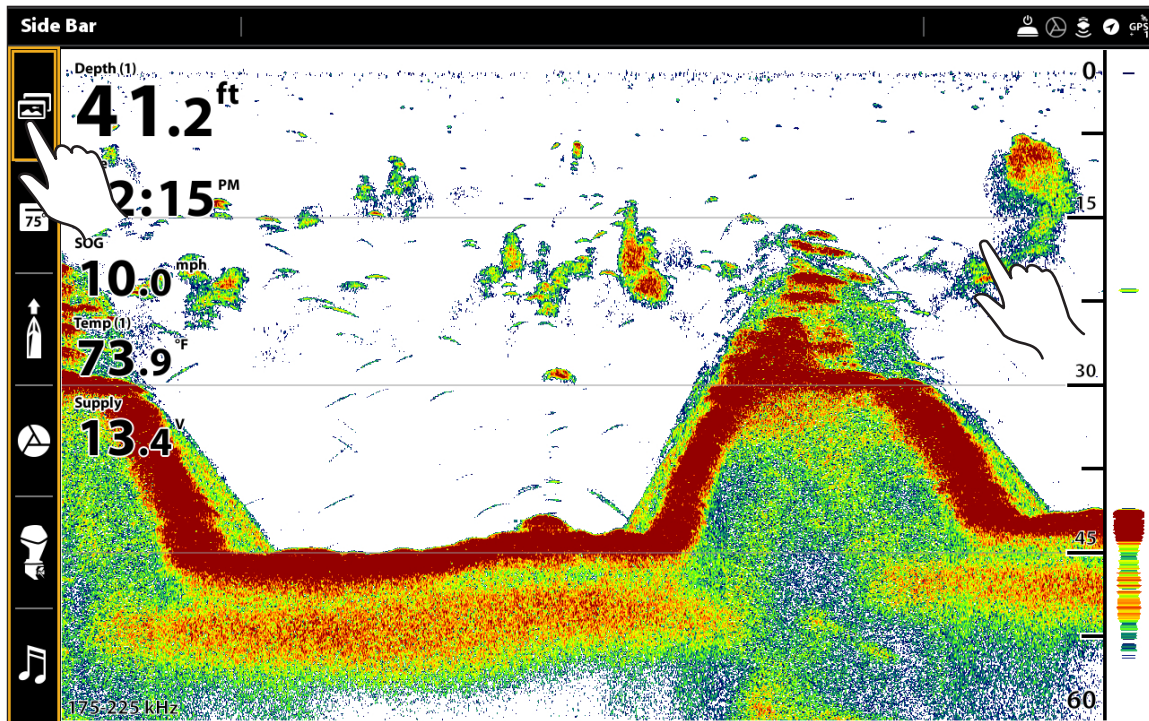

Tap to Select (Open)

OR

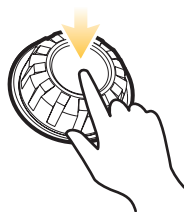

Open

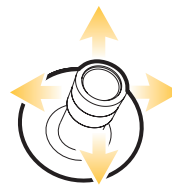

Select



Display

Save a View to the Favorite Views Widget

1. Press the HOME key.
2. Open the Views tool.
3. Select a view to display.
4. Once the view is displayed, tap the Favorite Views widget in the side bar, or press the Rotary dial.
5. Select the position in the Favorite Views list to save the displayed view. Press and hold an existing Favorite View to replace it, or tap the plus icon to save the new view to an open box (save up to 12 views on APEX or 10 views on SOLIX).

EDIT THE ON-SCREEN VIEW

You can edit a view from the Views tool or from the view that is displayed on the screen. When you edit a view from on-screen, the View Options menu provides additional editing options.



Global: To apply changes to all views in the same category, turn on Global. To apply changes to the on-screen view exclusively, turn off Global.

The menu options in Data bar, Options, Preferences, and Overlays change to match the on-screen view. The menu options are described in detail in each section. For example, for Sonar Overlay settings, see **Sonar Overview**.

Change the View Appearance (Preferences)

Use the Preferences menu to change the appearance of the display. The menu options are determined by the type of view on-screen, and there are many options for each view. For example, in a Sonar View, you can choose the palette, turn on Fish ID+, display or hide the Real Time Sonar Window, and more.

1. With a View displayed on-screen, tap the view [or pane] name in the status bar, or press the MENU key once.
2. Select Options. For example, in a Sonar View, select Sonar Options. In a Chart/Sonar View with the Chart pane selected, select Chart Options.
3. Select Preferences.
4. Use the touch screen or Joystick to select a menu and change a setting.

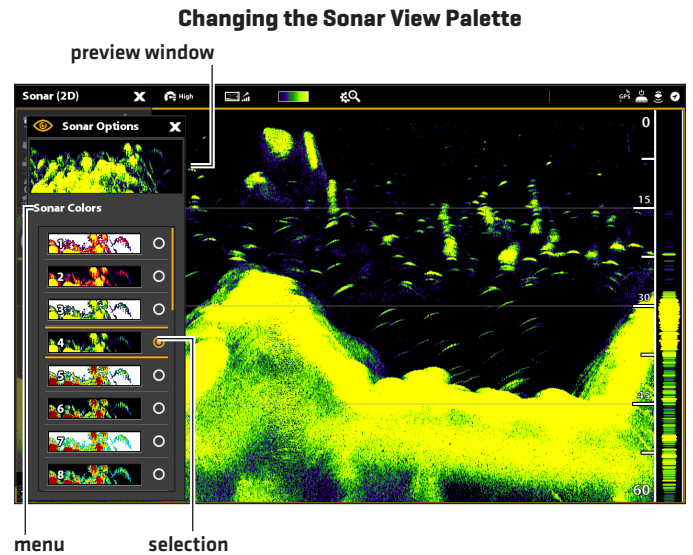

Change the View Overlays

Use the Overlays menu to display or hide information on the view. For example, in a Chart View, you can display or hide the vessel icon, and you can choose which navigation data [waypoints, routes, tracks, etc.] you want to display on the view.

1. With a View displayed on-screen, tap the view [or pane] name in the status bar, or press the MENU key once.
2. Select Options. For example, in a Sonar View, select Sonar Options. In a Chart/Sonar View with the Chart pane selected, select Chart Options.
3. Select Overlays.
4. Use the touch screen or Joystick to select a menu and change a setting. [check mark = visible, blank = hidden].

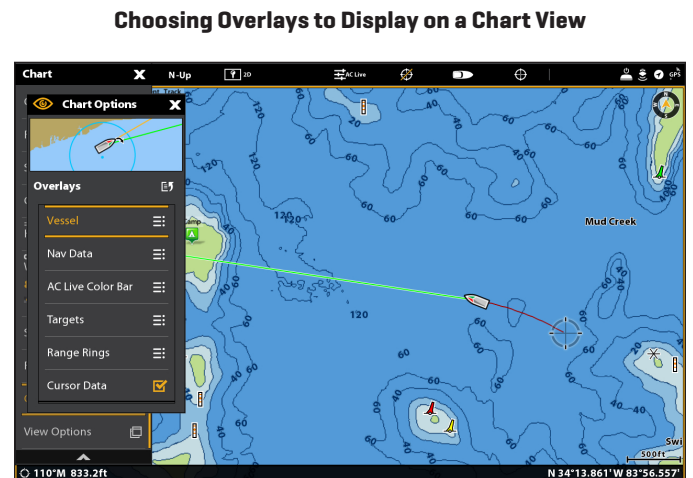

Display Data Overlays

Digital readout data can be displayed as an overlay, and it can be displayed in the data bar. To turn on the data bar, see the next section *Display a Data Bar*.

Display an Overlay on the View

1. With a View displayed on-screen, tap the view (or pane) name in the status bar, or press the MENU key once.
2. Select View Options.
3. Select Data Overlays.
4. **Turn On Data Overlays:** Select Overlay. Tap the on/off button, or press the ENTER key, to turn it on.
- 5a. **Select by Data Type:** Under System Overlays, select the type of data overlay (Sonar, Chart, Navigation, etc.).
For example, to display navigation data like Heading, Course Over Ground (COG), Speed, etc., select Navigation.
- 5b. **Select by Overlay Position, Color, and Size:** Under System Overlays, select from Overlay 1 through Overlay 5.

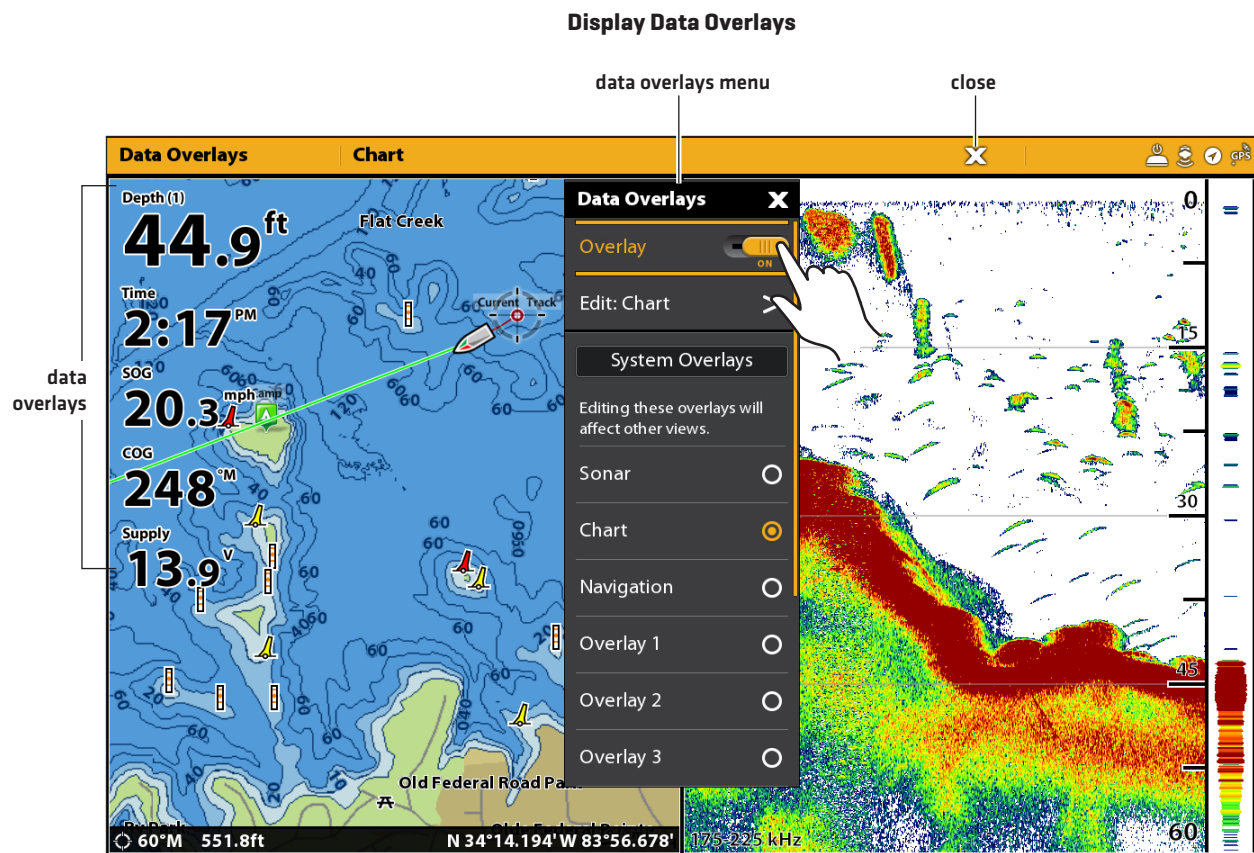

Change the Overlay Data

Use the following instructions to customize the data displayed in the data overlay. You can also change the overlay color, size, and position on the view.

1. Open the View Options menu.
2. Select Data Overlays.
3. Select the **Edit**: menu.

For example, if you have the Sonar overlay displayed, select Edit: Sonar. If you have the Chart overlay displayed, select Edit: Chart.



NOTE: Any changes to the selected overlay will be applied to other views. To apply changes to the currently displayed view, select View Overlay from the Data Overlays menu (you may have to scroll to the bottom of the menu).

4. Select Edit Data.
5. Select an overlay position to change. Tap, or use the Joystick to select and press the ENTER key.
6. Select the new data category.
7. Select the data type.
8. Press the EXIT key.
9. **Repeat:** Repeat steps 5 through 8 to change more data overlays.
10. **Back:** Tap the Back icon to return to the previous menu.

OR

Close: Press the EXIT key until the menu is closed.

Selecting an Overlay Position

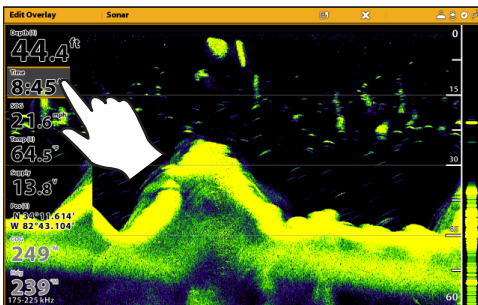

Selecting the Data Category

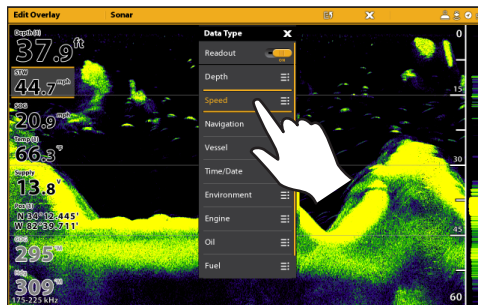

Selecting the Data Type

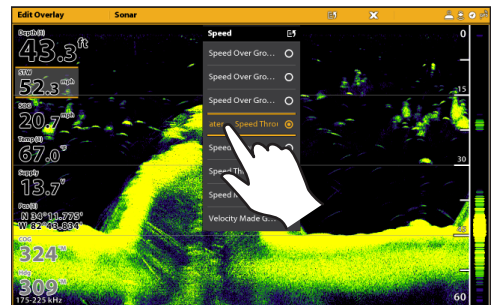

Turning an Overlay On/Off

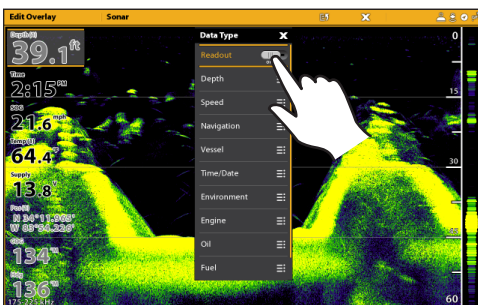

Change the Overlay Appearance

You can also change the overlay color, size, and position on the view.

1. Open the View Options menu.
2. Select Data Overlays.
3. Select the **Edit:** menu.

For example, if you have the Sonar overlay displayed, select Edit: Sonar. If you have the Chart overlay displayed, select Edit: Chart.

4. Set the following menus to your preference:

| | |
|-------------------------|---|
| Overlay Position | Change the position of the overlay on the screen. |
| Overlay Size | Change the font size. |
| Overlay Color | Change the font color. |

5. **Back:** Tap the Back icon to return to the previous menu.

OR

Close: Press the EXIT key until the menu is closed.

Display a Data Bar

Your control head allows you to choose a standard data bar or a navigation data bar with preset data boxes. If you attach additional accessories to the control head or network, additional data bar options may also be displayed. The data boxes in the data bar can also be changed.

Display a Data Bar

1. With a view displayed on-screen, press the PANE key once. In a multi-pane view, press the PANE key repeatedly until the menu displays.
2. Select the type of data bar [standard, navigation, i-Pilot Link, etc.] to display from the side bar.

To keep the data bar displayed on the view, tap the pin icon at the bottom of the data bar.

Close: Tap the X icon.



NOTE: To display digital readouts as an overlay, see *Display Data Overlays*.

Displaying a Data Bar

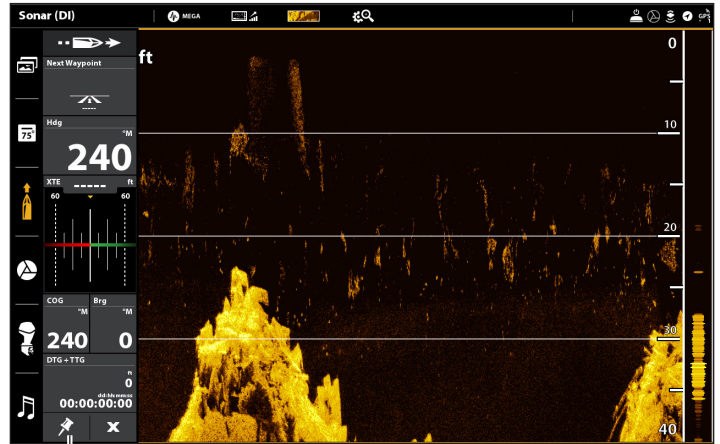
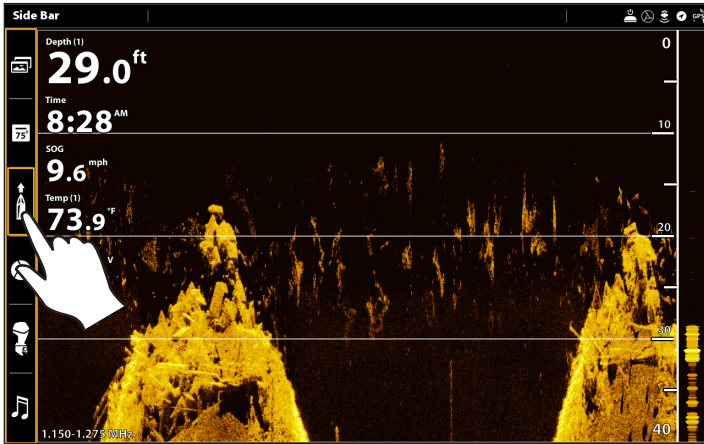

select to keep the data bar displayed (otherwise, it will automatically close)



Tap to Select (Display)

OR



Open

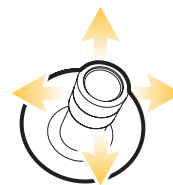

Select



Display

Data Bars with Multiple Tabs or Data Boxes

Some of the data bar options include multiple tabs and data boxes. The standard Data Bar and the Favorite Views widgets both use two tabs.

To open a second tab:

1. Tap the tab.

OR

Press the PANE key. Use the Joystick to select the tab, and press the ENTER key.

To open additional data boxes:



If a data box contains three horizontal lines, it includes a submenu with additional data.

1. Tap on the lines, or select the data box and press the ENTER key.

Data Bar Tabs

open the second tab to see more digital readout boxes

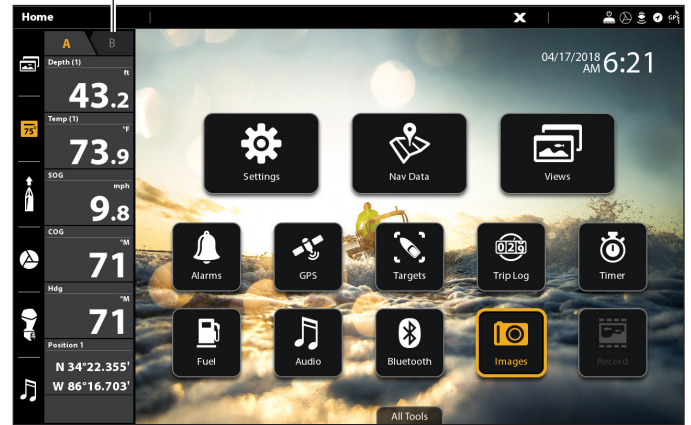

Opening a Submenu

select to access more data

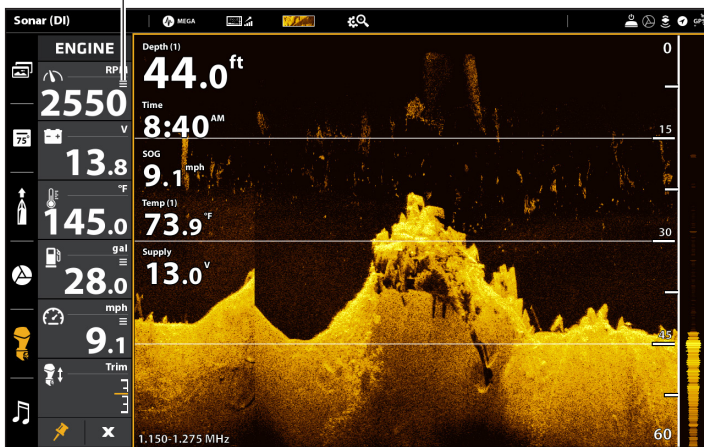

Returning to the Data Box Menu

back

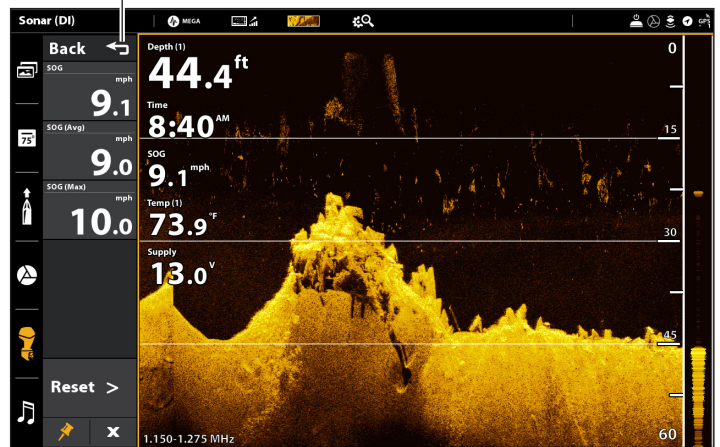

Tap

OR



Open

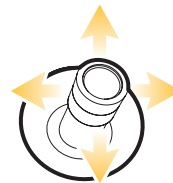

Select



ENTER

Change the Data Boxes

Use the following instructions to change the data boxes displayed in a data bar.



NOTE: A data bar must be displayed to access the menu options in this section. See **Display a Data Bar**.

1. **View Options Menu:** With a view displayed on-screen, press the PANE key once. In a multi-pane view, press the PANE key repeatedly until the menu displays.
2. Select Edit Data.
3. To edit the Standard data bar, select Standard Data. To edit the Navigation data bar, select Navigation Data.
Global (Optional): To apply the changes to all views using the data bar, turn on Global. To apply changes to the on-screen view exclusively, turn off Global.
4. Use the Joystick to choose a data box. Press the Joystick to select it.
5. Select a data type from the menu.
6. Select a data label.
7. **Close:** Press the EXIT key.

Selecting a Data Box



Selecting the Data Type

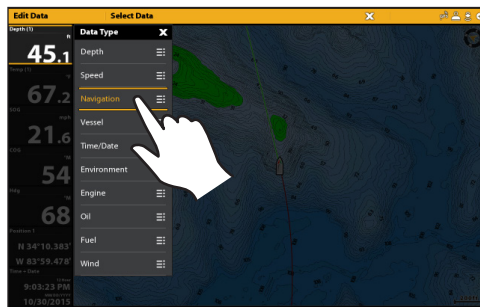

Selecting the Data Label

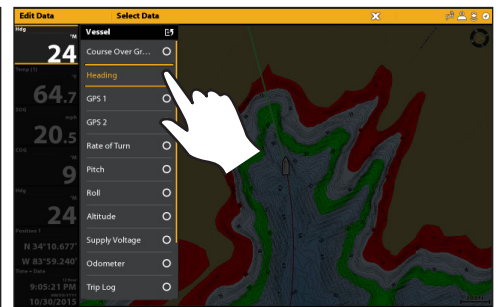

Tap to Select

OR

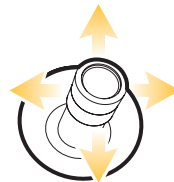

Select



Open

Understand Data Box Digital Readouts

The table below displays the basic data box options that are shown in the Standard data bar and the Navigation data bar, as well as the additional data box options for vessel, wind, and engine. The data box options are determined by the installed equipment and the selected sources on the network. Your control head provides a wide variety of data box options, more than the information shown here.

The number on the data label [Temp 1, Temp 2, Temp 3, etc.] corresponds with the source number. For more information about sources and networking, see *Installation Information*, *Set up your NMEA 2000 Network*, and *Set up your Humminbird Network: Select Data Sources*.

| Label | Name | Description | Data Type |
|--------------|---------------------------|---|------------|
| Alt | Altitude | The height measurement above sea level. | Vessel |
| AWA | Apparent Wind Angle | The direction of wind relative to the bow of the vessel. | Wind |
| AWS | Apparent Wind Speed | The speed of wind with respect to the speed of the vessel. | Wind |
| Brg | Bearing | The compass direction from the vessel position to the next waypoint or route point. | Navigation |
| Brg [End] | Bearing [To End] | The compass direction from the vessel position to the final point in a route. | Navigation |
| Course | Course | The intended direction of travel measured between the start point and end point. | Navigation |
| CMG | Course Made Good | The bearing from your starting position to the present vessel position. The goal is to have CMG and Track equal to the same number. | Navigation |
| COG | Course Over Ground | The current direction the boat is traveling measured in degrees from North. When the COG is equal to Bearing, the boat is said to be on course and will arrive at the destination in the most efficient manner. | Vessel |
| CTS | Course to Steer | The heading that must be maintained in order to reach the planned destination. | Navigation |
| Depth [#] | Depth | The depth of the water from the transducer or digital depth sensor to the bottom. This measurement includes the depth offset setting. | Depth |
| Dest Wpt ID | Next Waypoint | The next point [waypoint, route point, Man Overboard point, etc.] that the vessel is navigating towards in a route or other navigation mode. | Navigation |
| DBT | Depth Below Transducer | The depth of the water below the transducer. This measurement does not include the depth offset setting. | Depth |
| DMG | Distance Made Good | The straight line distance actually traveled between the start position to the current vessel position. | Navigation |
| DTG | Distance to Go | The distance between the vessel position and the next waypoint or route point. | Navigation |
| Eng Temp [#] | Engine Temperature | The engine temperature from the engine source. | Engine |
| Eng Volt [1] | Engine Voltage | The power supplied to the engine source. | Engine |
| ETA | Estimated Time of Arrival | The estimated time of arrival to the next waypoint on the route. | Navigation |

| Label | Name | Description | Data Type |
|---------------------|------------------------|--|------------------|
| Fuel [#] | Fuel Level | The fuel level of the fuel source. | Fuel |
| Hdg | Heading | The direction the boat is pointing, measured in degrees. Due to wind and waves, the boat is often traveling in a slightly different direction than its heading. See Course Over Ground [see COG]. | Vessel |
| Heat Index | Heat Index | The perceived temperature derived from air temperature and relative humidity. | Environment |
| Next Turn | Next Turn | The course of the next route leg with respect to the current heading. | Navigation |
| Odo | Odometer | The distance traveled. | Vessel |
| Pitch | Pitch | The rotation angle of the boat from front to back [bow to stern]. | Vessel |
| Position [#] | GPS | The latitude and longitude coordinates of the vessel position based on the GPS receiver installation location. | Vessel |
| Roll | Roll | The rotation angle of the boat from side to side [port to starboard]. | Vessel |
| ROT | Rate of Turn | The rate at which the boat is turning, measured in degrees per second. | Vessel |
| RPM | Revolutions Per Minute | The number of engine revolutions per minute. | Engine |
| SMG | Speed Made Good | The distance from the starting waypoint on the route divided by the time elapsed since starting navigation on the route. | Speed |
| SOG | Speed Over Ground | The measurement of the boat's progress across a given distance and the speed measurement provided by GPS. SOG is optimal for navigation because accurate destination times can be derived from this measurement. | Speed |
| STW | Speed Through Water | The measurement of the flow past the boat, which may vary depending on current speed and direction. | Speed |
| Temp [#] | Water Temperature | The detected water temperature. | Environment |
| Temp [Air] | Air Temperature | The detected air temperature. | Environment |
| TTG | Time to Go | The estimated time required to reach the next waypoint on the route. TTG is calculated using the SOG [Speed Over Ground] and DTG [Distance to Go]. | Navigation |
| TWA | True Wind Angle | The wind angle detected when the vessel is stationary. | Wind |
| TWS | True Wind Speed | The wind speed detected when the vessel is stationary. | Wind |
| VMG | Velocity Made Good | The speed of travel relative to the next waypoint on the route. | Speed |
| XTE | Cross Track Error | The straight-line distance of the boat from the intended Track. XTE measures how far the boat is off course. | Navigation |

THE VIEW OPTIONS MENU

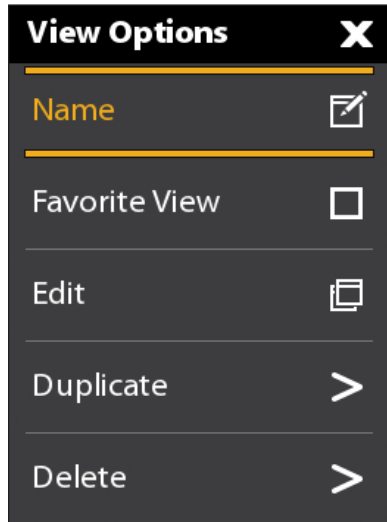

The **View Options menu** provides options to edit the selected view. You can open the View Options menu from the on-screen view or from the Views tool on the Home screen.

The menu options vary slightly. For example, if you open the View Options menu from an on-screen view, you can also edit the data bar from the menu. If you open the View Options menu from the Views tool, you can duplicate and delete the view from the control head.

Open the View Options Menu for the On-Screen View

1. With a view displayed on-screen, press the MENU key.
2. Select View Options.

Opening the View Options Menu

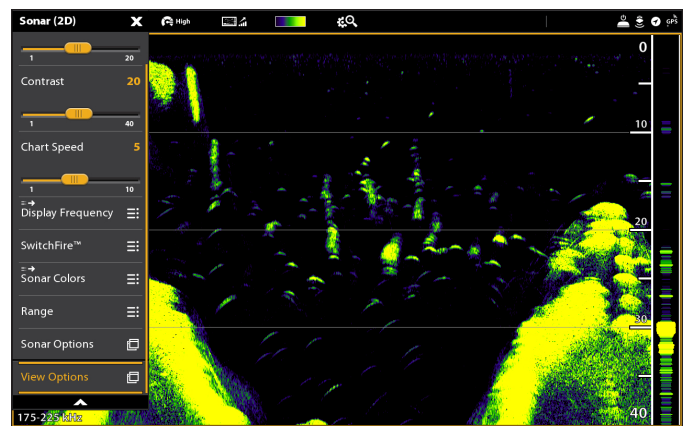

Turn the Side Bar On/Off

You can turn the side bar on or off using the View Options menu. Set the side bar to stay displayed to view live data along with the display, or close the side bar to view more of the display.

You can customize the data boxes displayed in the data bars. See *Edit the On-Screen View*.

1. With a View displayed on-screen, tap the view [or pane] name in the status bar, or press the MENU key once.
2. Select View Options.
3. Select Side Bar.
4. Tap, or press the ENTER key, to change the setting. [check mark = visible, blank = hidden]

Turning Off the Side Bar

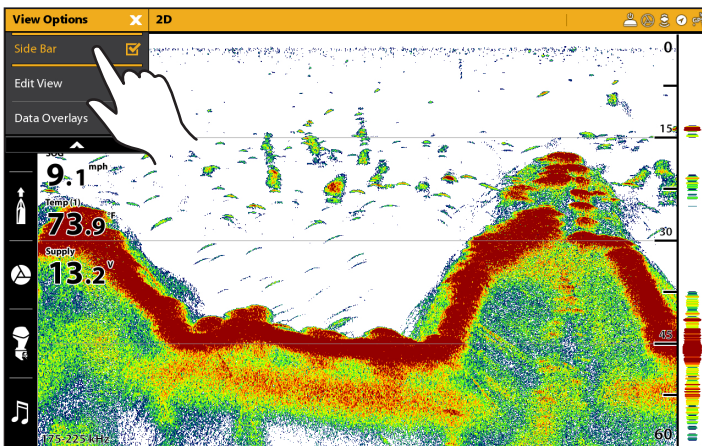

Sonar View (with Side Bar Set to Off)

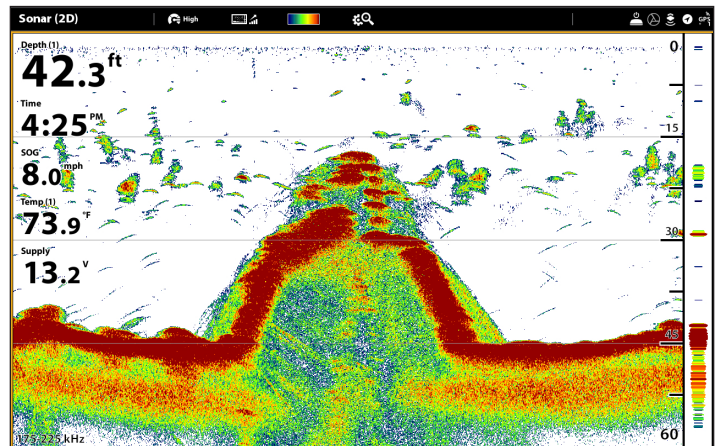

Tap

OR

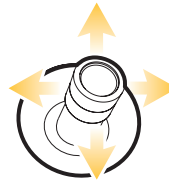

Select



ENTER

Open the View Options Menu from the Views Tool

1. Press the HOME key.
2. Select the Views tool.
3. Use the Joystick to select a view. Press the MENU key.
4. **Close:** Press the EXIT key.

Opening the View Options Menu from the Views Tool

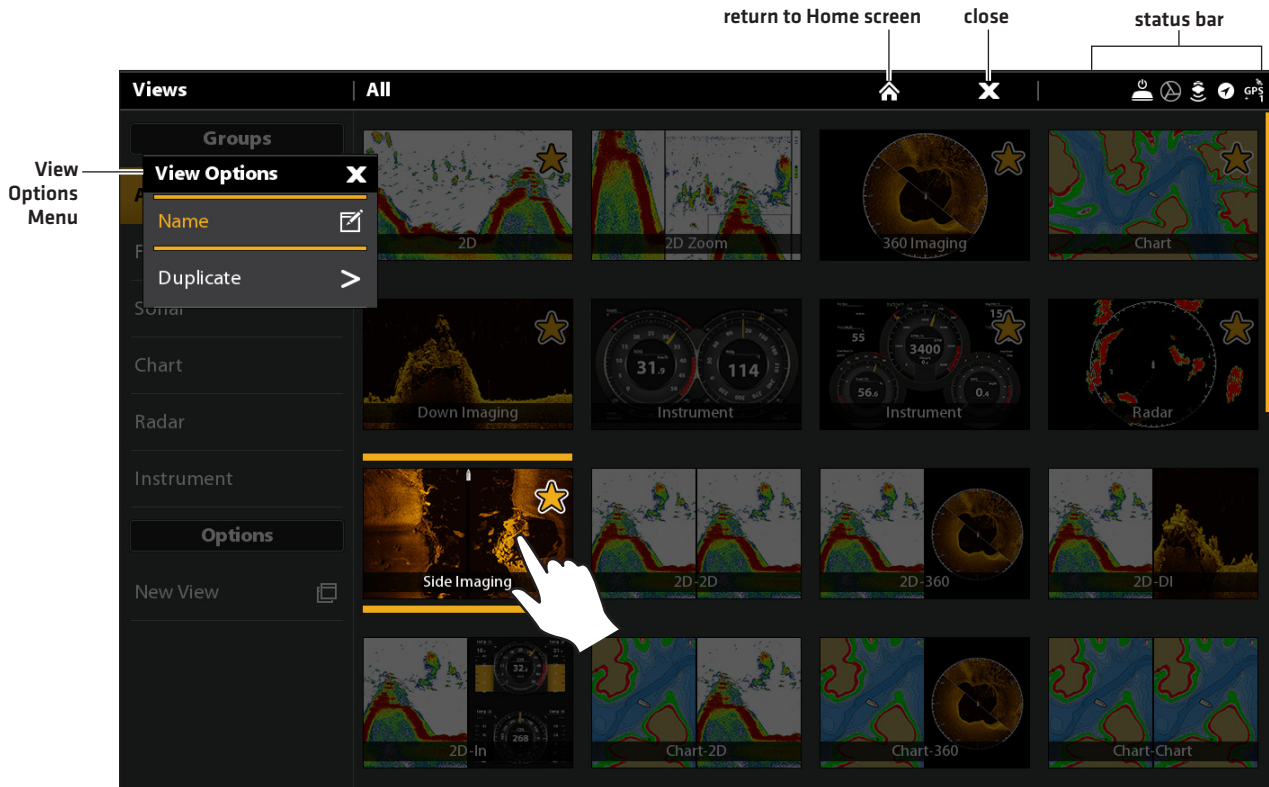

Press and Hold

OR

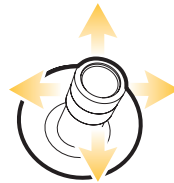

Select



Open the View
Options Menu

CREATE A NEW VIEW

Follow the instructions in this section to create a new view from a blank template.

1. Press the HOME key.
2. Select the Views tool.
3. Select New View.
4. See *Edit the View Layout and Application* to rename the view, edit the layout, add applications, display digital readouts, and more.

Creating a New View

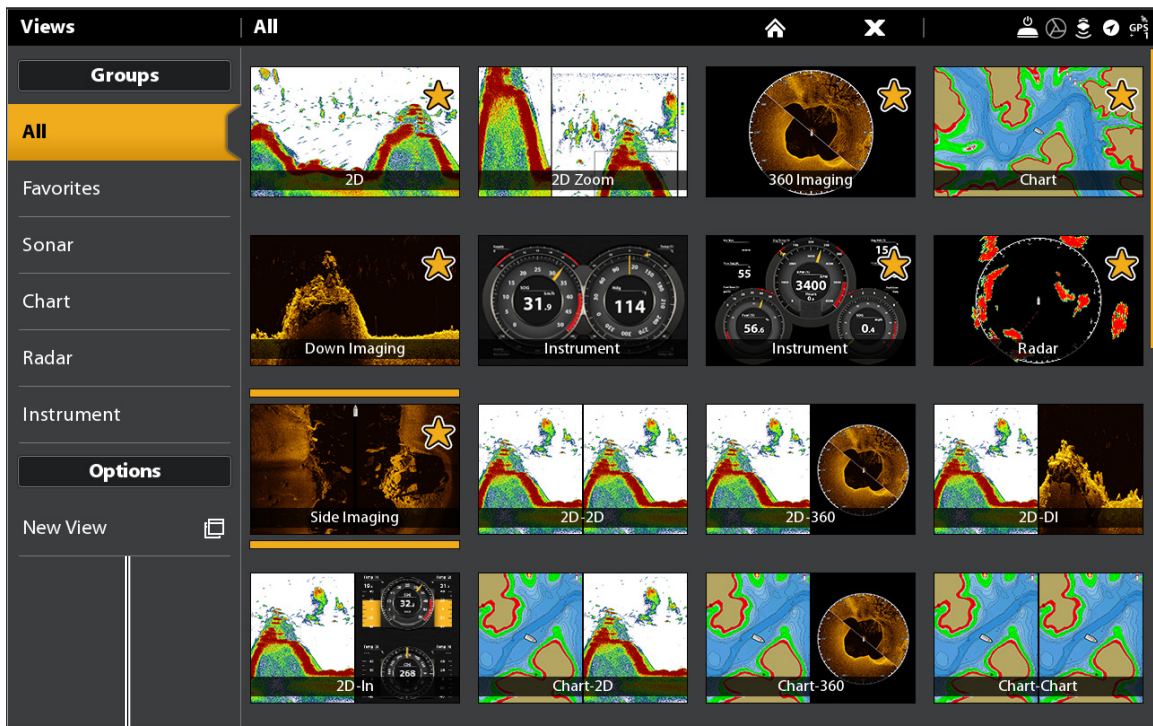

select to create a new view

Edit the View Layout and Application

The Edit menu on the View Options menu allows you to change the type of data that is displayed in the view and how many panes are displayed.

1. Select Edit (or Edit View) from the View Options menu.

To change the layout and number of panes in the view, select Template. If you do not want to change the layout, skip to step 4.

2. Tap the template, or use the Joystick, to select the layout you want to use.
3. To change the type of data displayed in the view, select Applications.
4. Tap the pane and then tap the type of data to fill the pane.

OR

Turn the Rotary dial to select a pane. Use the Joystick to choose an application, and press the Joystick to select it.

5. Repeat steps 4 and 5 until the panes are filled.
6. Select Save.

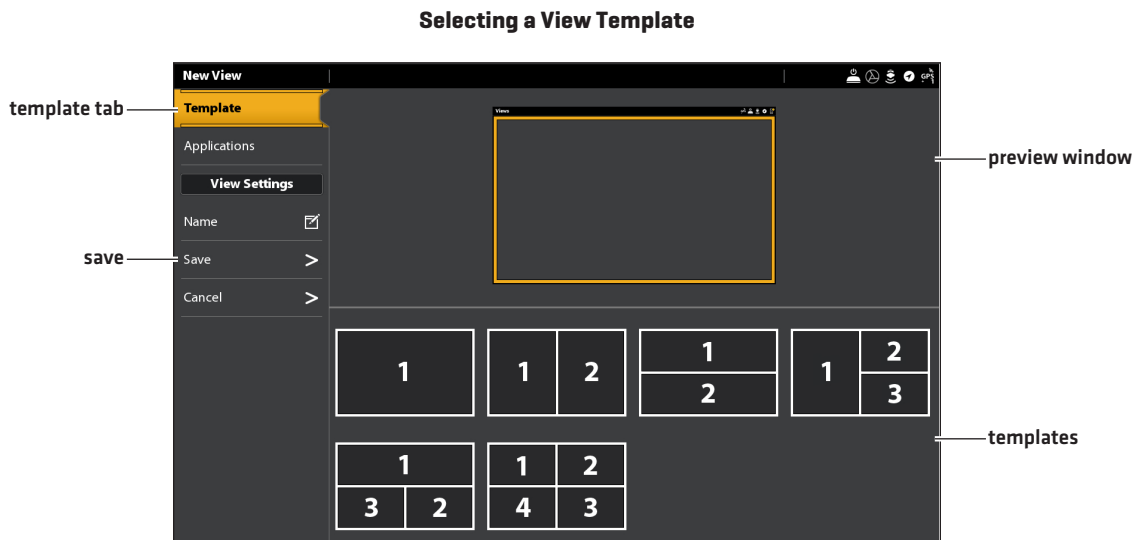

Tap to Select

OR

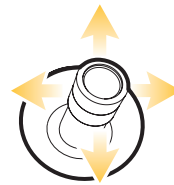

Select a Template

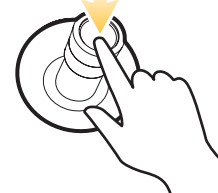

Open

Adding Applications to the Template

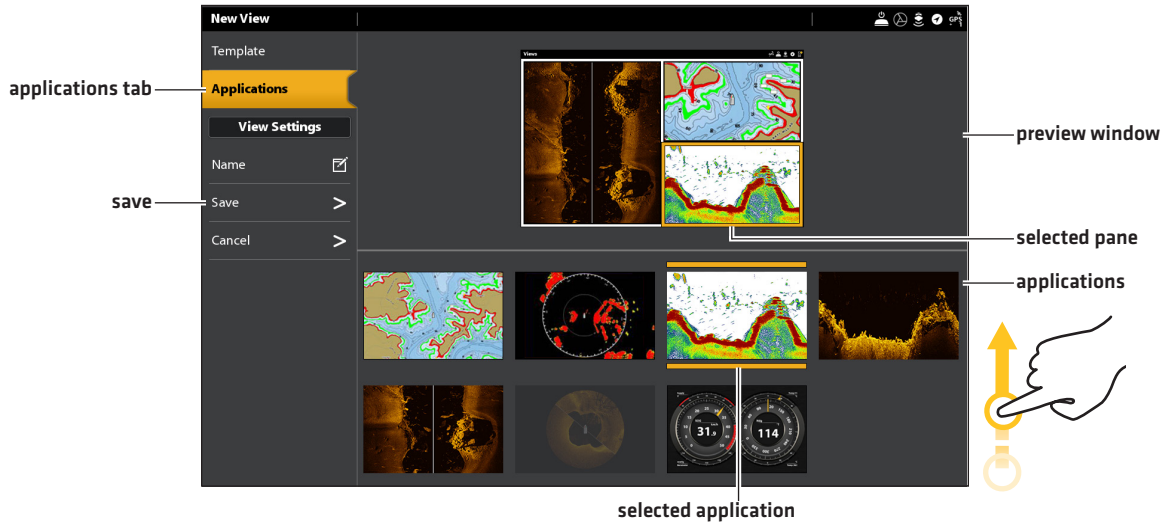

Tap to Select

OR



Select a Pane

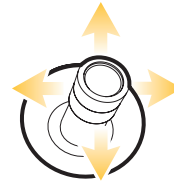

Select an Application

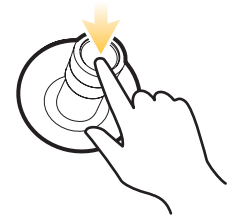

Add

Change the View Name (Views Tool)

1. Select Name from the View Options menu.
2. Use the on-screen keyboard to edit the view name. See *The Menu System: Tips for Using the On-Screen Keyboard* for more information.

Duplicate the Selected View (Views Tool)

When you duplicate a view, the control head creates a copy. You can rename the new view, edit it, and change the layout.

1. Select Duplicate from the View Options menu.
2. Tap the menu, or press the ENTER key, to create a copy.

Delete the Selected View (Views Tool)

1. Select Delete from the View Options menu.
2. Tap the menu, or press the ENTER key, to delete the view.

SET UP AN INSTRUMENT VIEW

The APEX/SOLIX control heads provide Instrument Views in a variety of combinations to display on-screen. You can use the standard Dashboard Instrument View or Engine Instrument View. You can also customize the gauges, data boxes, and ranges.



NOTE: The data boxes and gauges must have input from connected and powered equipment. The Engine Instrument View must have input from a NMEA 2000 network to provide source data. For more information about sources and networking, see *Installation Information*, *Set up your NMEA 2000 Network*, and *Set up your Humminbird Network*.

Instrument View: Dashboard

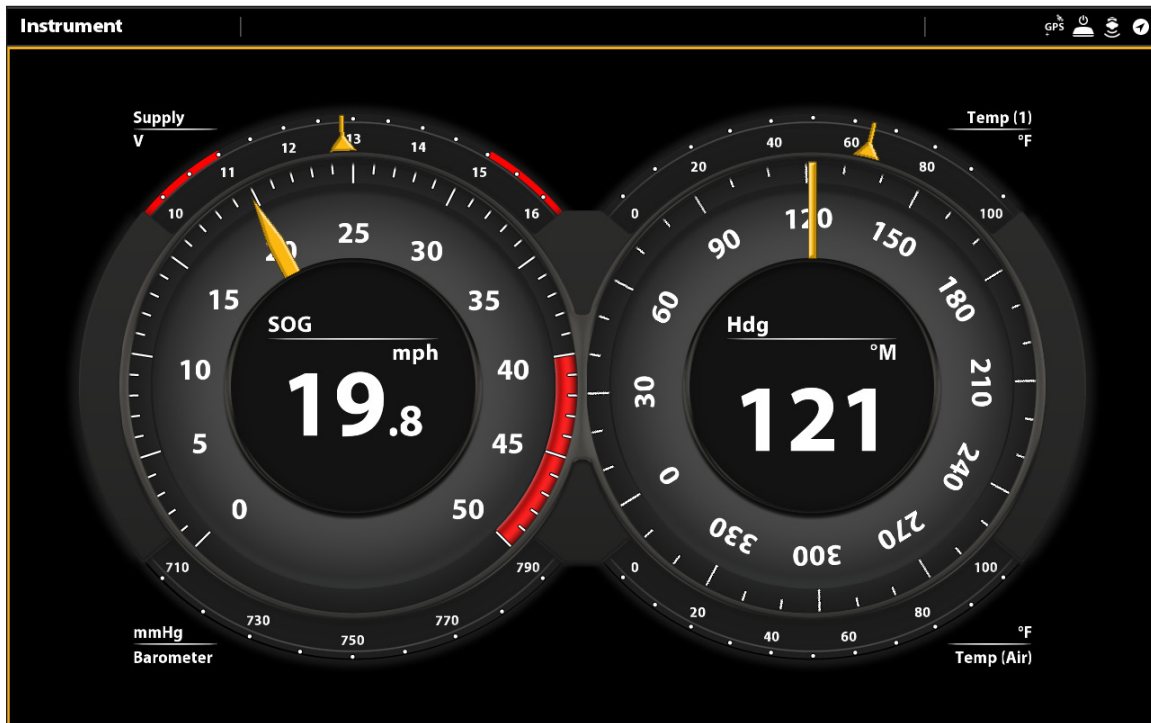

Display an Instrument View

Touch Screen

1. Press the HOME key.
2. Select the Views tool.
3. Under Groups, select Instrument.
4. Tap an Instrument View.
5. Tap Instrument in the status bar.
6. Select Dashboard or Engine.

Keypad

1. Press the HOME key.
2. Select the Views tool.
3. Under Groups, select Instrument.
4. Use the Joystick to choose an Instrument View. Press the Joystick.
5. Press the MENU key.
6. Select Dashboard or Engine.

Customize an Instrument View

In an Instrument View, you can customize the gauges, data boxes, and ranges. You can change each item in the same way you change data boxes in a view. You can also set up warning limits for the selected data range.

 **NOTE:** The available changes and sources are determined by the selected gauge or data box. As you change data, the available sources are displayed in white, and the unavailable sources are displayed in black.

Touch Screen

1. With an Instrument View displayed on-screen, tap Instrument in the status bar.
2. Select Edit Instrument.
3. Tap a gauge or data box.
4. **Change the Type of Data:** Select Data Type. Select a category and a data type from the menus.
5. **Change the Displayed Range:** Select Data Limits. Select a range from the list.

Set the Warning(s) Threshold: Select a warning [if available], and tap the on/off button to turn it on. Press and hold the slider to set the warning threshold.

6. **Close:** Press and hold the EXIT key.

Keypad

1. With an Instrument View displayed on-screen, press the MENU key.
2. Select Edit Instrument.
3. Use the Joystick to select a gauge or data box. Press the ENTER key.
4. **Change the Type of Data:** Select Data Type. Select a category and a data type from the menus.
5. **Change the Displayed Range:** Select Data Limits. Select a range from the list.

Set the Warning(s) Threshold: Select a warning [if available], and press the ENTER key to turn it on. Turn the Rotary dial to set the warning threshold.

6. **Close:** Press and hold the EXIT key.

Selecting a Gauge

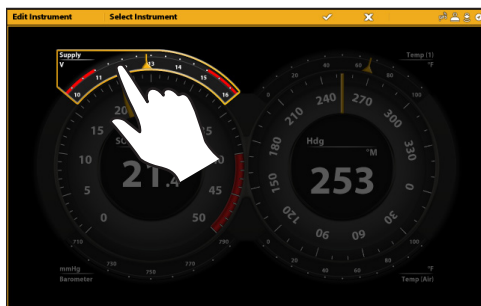

Selecting a Radial Gauge

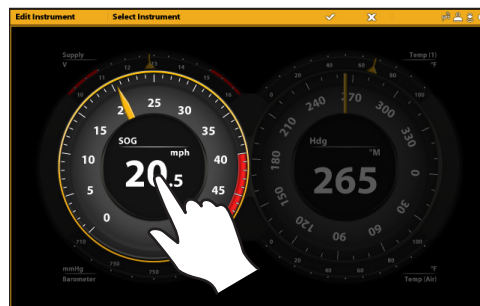

Selecting a Data Box

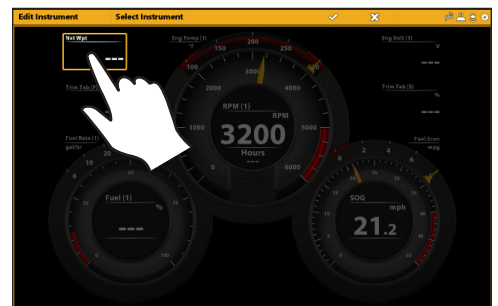

Press and Hold

OR

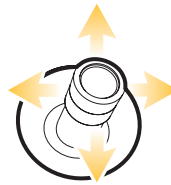

Select



Open

SET UP AN HDMI VIEW (APEX ONLY)

The APEX control heads provide HDMI video input and output. This allows for video input, such as a camera, and output for connection to an accessory display. The APEX supports the following input/output resolutions:

| HDMI In | | | HDMI Out | | |
|------------|------|-------|------------|------|-------|
| 640x480p | 4:3 | @60Hz | 720x480p | 16:9 | @60Hz |
| 720x480p | 16:9 | @60Hz | 1280x720p | 16:9 | @60Hz |
| 1280x720p | 16:9 | @60Hz | 1920x1080p | 16:9 | @60Hz |
| 1920x1080p | 16:9 | @60Hz | 1280x720p | 16:9 | @50Hz |
| 720x576p | 16:9 | @50Hz | 1920x1080p | 16:9 | @50Hz |
| 1280x720p | 16:9 | @50Hz | | | |
| 1920x1080p | 16:9 | @50Hz | | | |

Display a Video View

Touch Screen

1. Press the HOME key.
2. Select the Views tool.
3. Under Groups, select Video.
4. Tap a Video View.

Keypad

1. Press the HOME key.
2. Select the Views tool.
3. Under Groups, select Video.
4. Use the Joystick to choose a Video View. Press the Joystick.

Selecting a Video View

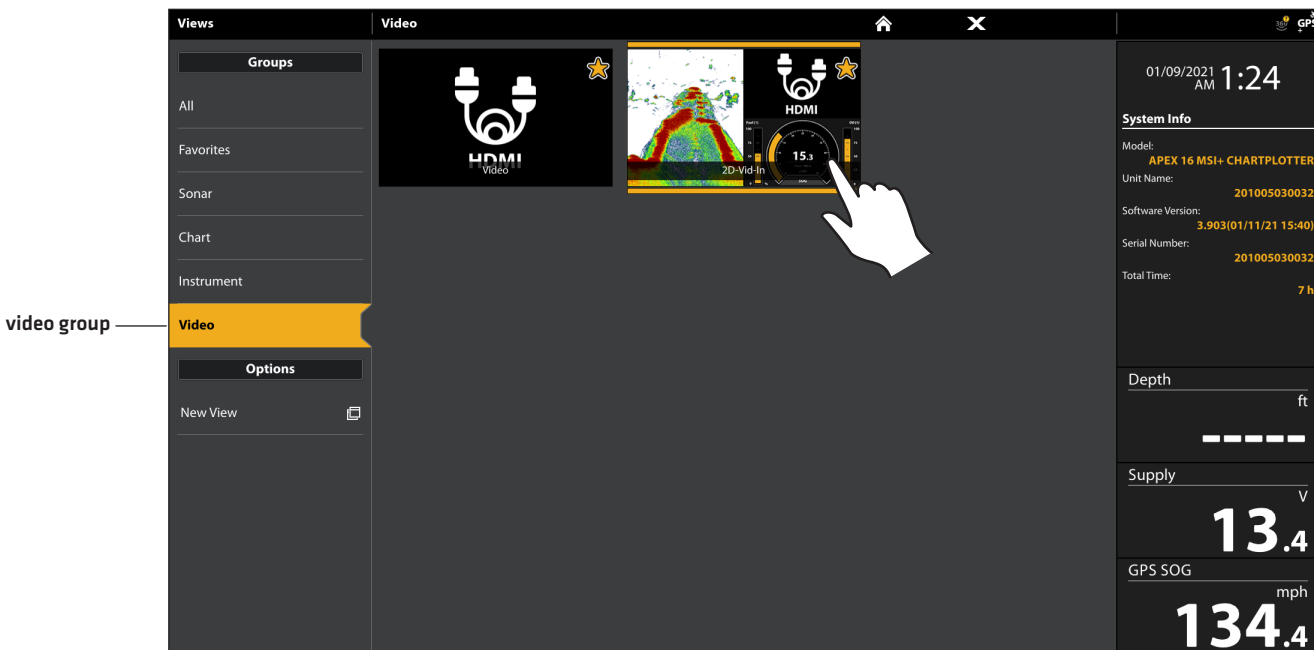

See [Create a New View](#) to add a Video view to a multi-panel screen.

Customize a Video View

In a Video View, you can customize the brightness and contrast.

Touch Screen

1. With a Video View displayed on-screen, tap Video in the status bar.
2. **Change the Brightness:** Select Brightness. Press and hold the slider to adjust the setting.
3. **Change the Contrast:** Select Contrast. Press and hold the slider to adjust the setting.
4. **Close:** Press and hold the EXIT key.

Keypad

1. With a Video View displayed on-screen, press the MENU key.
2. **Change the Brightness:** Select Brightness. Press the ENTER key to adjust the setting.
3. **Change the Contrast:** Select Contrast. Press the ENTER key to adjust the setting.
4. **Close:** Press and hold the EXIT key.

Customizing a Video View

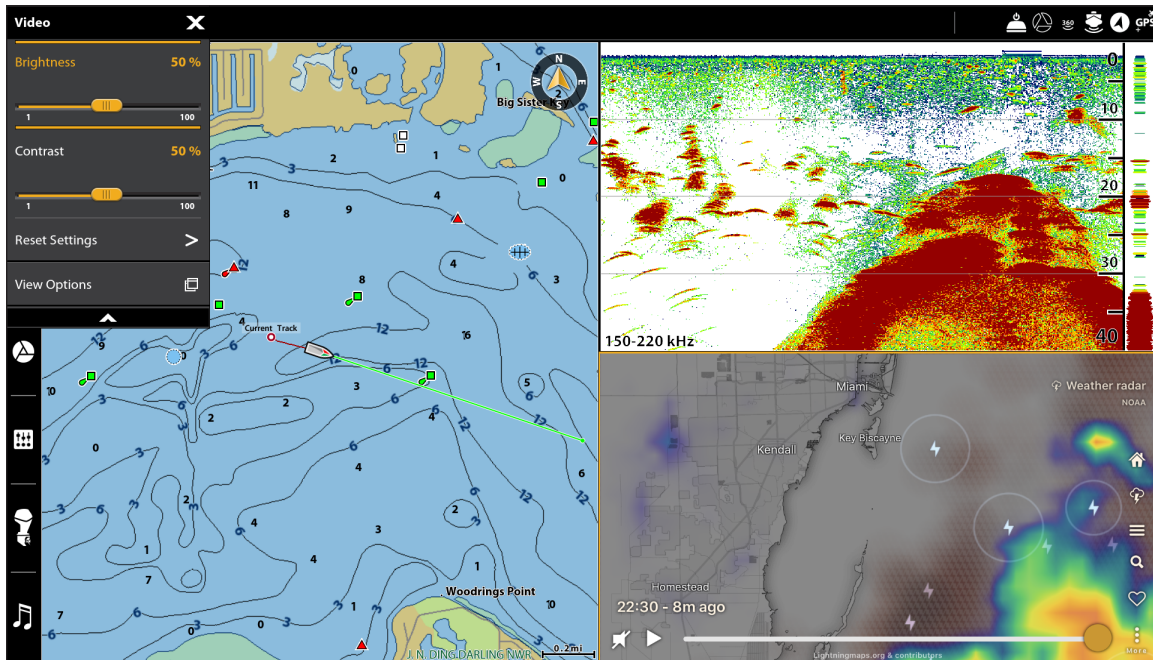

Press and Slide

OR

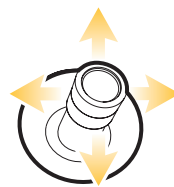

Select



Adjust the Setting

Map Source Overview

The APEX and SOLIX includes built-in charts by Humminbird, Navionics, and AutoChart Live. You can also install a microSD or SD map card with additional chart information for a particular location [separate purchase required]. Humminbird is the default map source, but you can change the map source at any time [see *Using the Built-in Charts*].

APEX/SOLIX control heads support the following charts [some require a separate purchase]:

| | |
|------------|---|
| Humminbird | Basemap [built in] |
| | CoastMaster, LakeMaster, Lake Master PLUS, SmartStrike, Aerial View, ChartSelect-downloaded maps and layers |
| | AutoChart, AutoChart PRO, AutoChart Live [built in], SI Mosaic |
| Navionics | Navionics [built in], Navionics Gold, HotMaps, Navionics Platinum+ |

Map Source: Humminbird Basemap

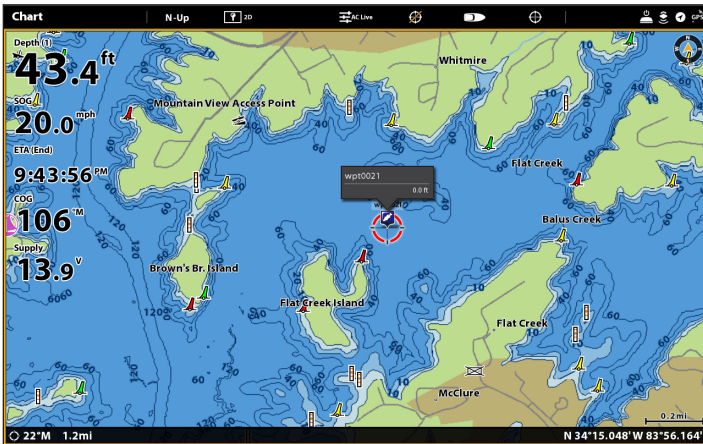

Map Source: Navionics

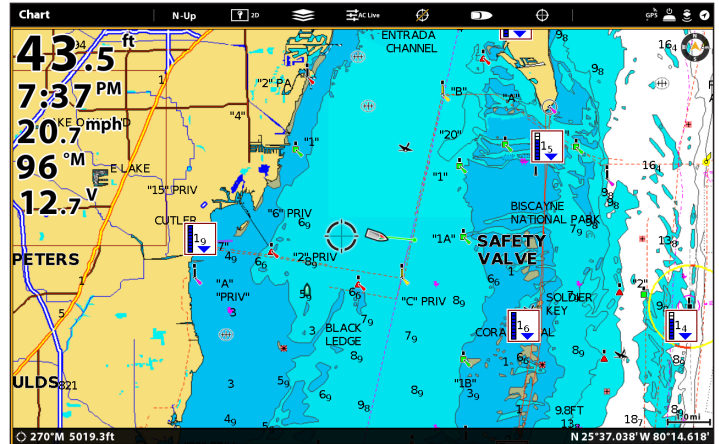

Map Source: SmartStrike Chart Card

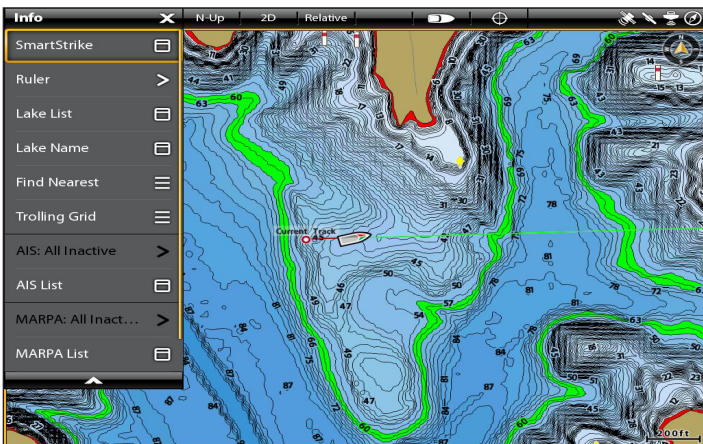

Map Source: AutoChart Live with Bottom Hardness Overlay [right pane]

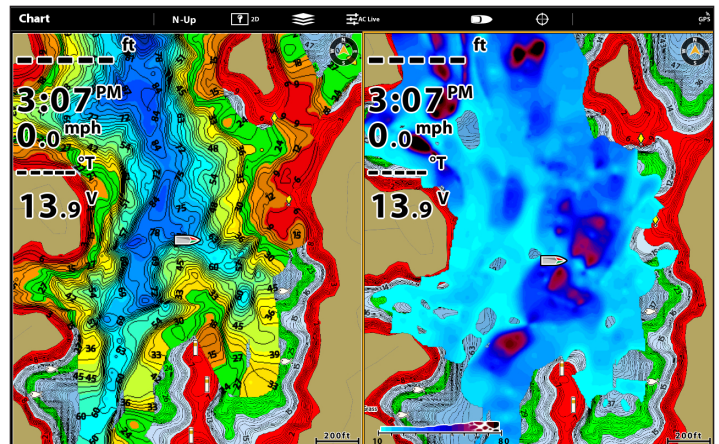

Map Source: CoastMaster Chart Card

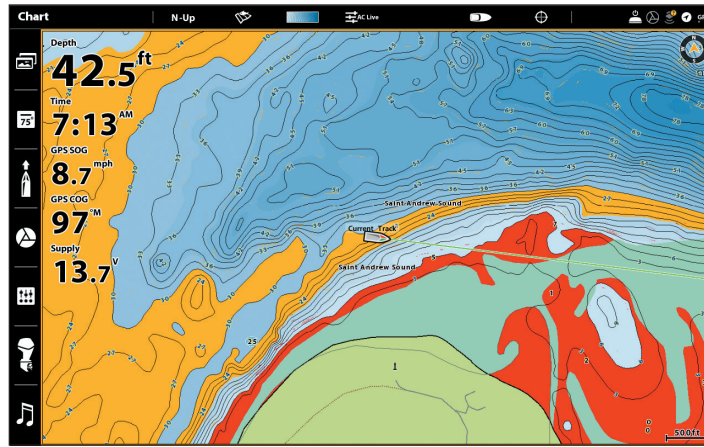

How the Map Source Affects your Chart View Operations

The selected map source influences the menu system. When you change the map source, the menu options for the Chart Views change, allowing you to add navigation data, shading, or alarms.

Install an SD or microSD chart card [separate purchase required] with specific maps or chart layers to add more detail to your Chart views [see *Using Chart Cards*].



NOTE: Visit our Web site at humminbird.com for the latest compatibility information.

Using Built-in Charts

The APEX and SOLIX includes built-in charts by Humminbird and Navionics. Display the built-in charts and add data overlays and map layers to customize your Chart view.

Humminbird Charts

When Humminbird is selected as the map source, you can use the system defaults, or you can set the menu settings to your preference. You can use the built-in Humminbird Basemap or a Humminbird SD Chart Card [see *Using Chart Cards*].

1. Select Humminbird as the map source.
2. Under Humminbird Charts, select Basemap or Legacy Chart Cards.

| | |
|----------------------------|---|
| Humminbird Basemap | Select the Humminbird Basemap to display contour data and navigation aids, including hazards, buoys, daymarkers, marinas, and other points of interest. The Basemap also shows depth markings and spot soundings [for coastal areas]. |
| Legacy Chart Cards* | Select the Legacy Chart Card to display the map data from the installed legacy chart card. *Required Equipment: Humminbird chart card. See <i>Using Chart Cards</i> for more information. |

Humminbird Basemap: Set the following menus to your preference:

| | |
|--------------------------------|---|
| Humminbird: Chart Card Info | Select this menu to review the information about the installed Humminbird chart card. |
| Text Size | Adjust the setting to change the size of font used in the Basemap. |
| Symbol Size | Adjust the setting to change the size of the symbols used in the Basemap. |

3. Proceed to **Navigation Alarms Overview** and **Customize the Chart View** for additional display options and alarm settings exclusive to Humminbird charts.

2D Chart View (Humminbird Basemap)

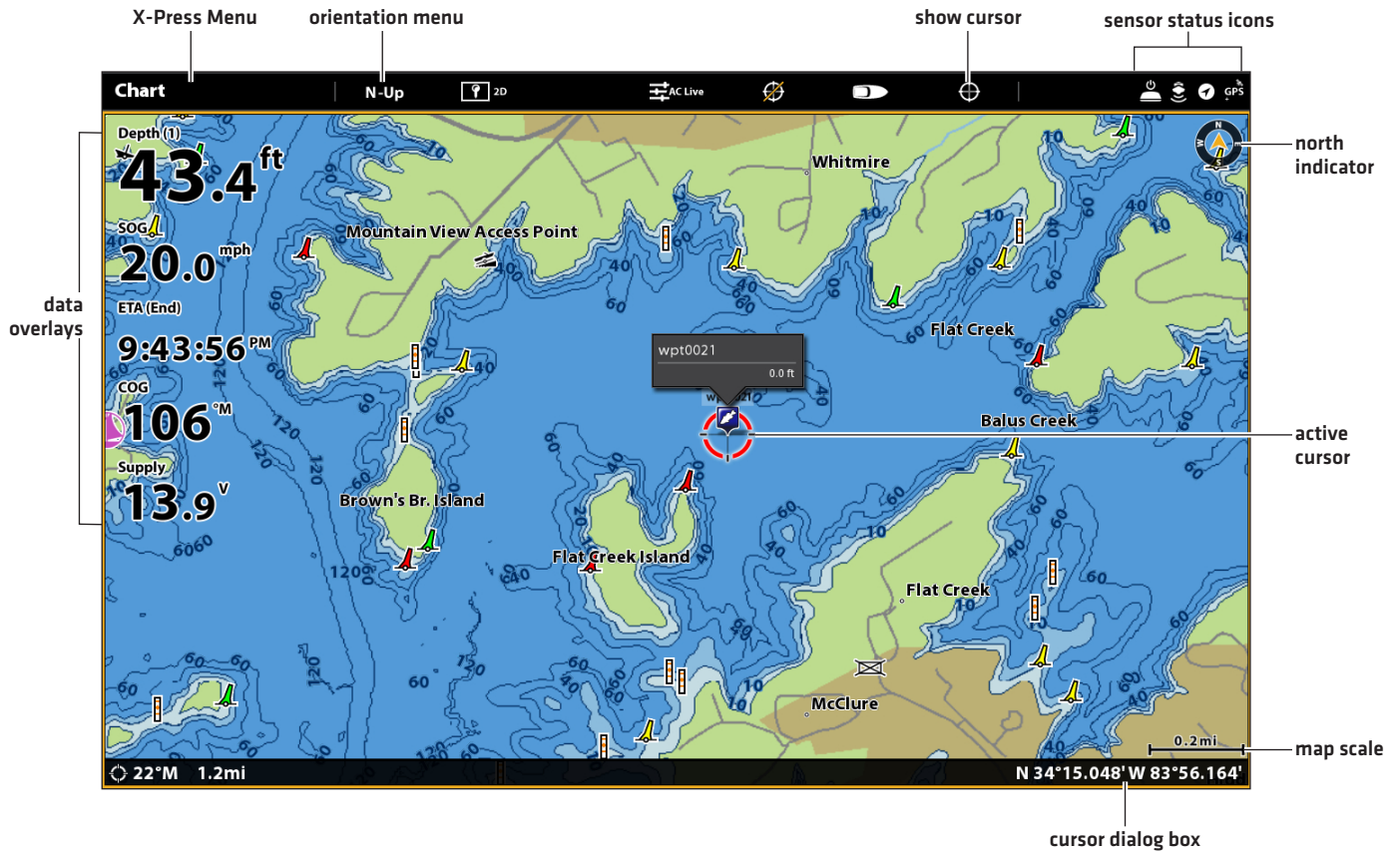

2D Chart View during Navigation

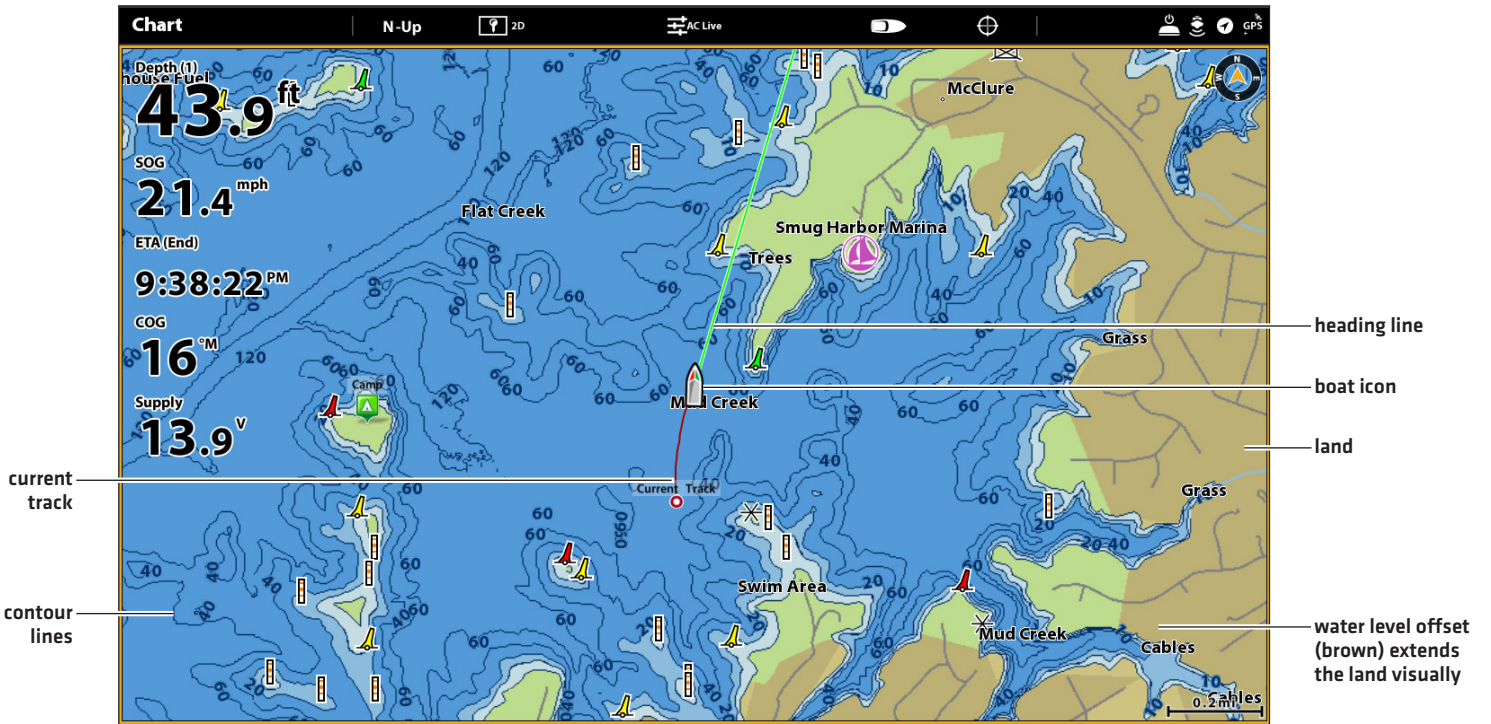

Navionics

When Navionics is selected as the map source, you can use the system defaults, or you can set the menu settings to your preference. You can use the built-in map, or you can install an SD chart card with additional features.

1. Select Navionics as the map source.
2. Set the following menus to your preference:

| | |
|---------------------------------------|---|
| Navionics: Chart Card Info | Select this menu to review the information about the installed Navionics chart card. |
| Easy View | Turn on Easy View to simplify the Chart View. The icon size and text size increase for easier viewing. |
| Dynamic Tides/ Currents | Turn on Dynamic Tides/Currents to display an icon on the Chart View that indicates the status of the tides and currents. The provided data is affected by the station's time zone. |
| Symbols | Select USA or International symbols to display on the Chart View. |
| Map Datum | Use Map Datum to change the map coordinate system used by the control head to match those of a paper map. Almost all electronic charts use the WGS84 Map Datum and most likely do not require a setting change. [Default = WGS84] |
| Chart Offset | Use Chart Offset to move the chart position on-screen and correct a position error in the cartography. Turn on Chart Offset, and use the sliders to adjust the latitude/longitude coordinates. The Chart Offset setting applies to all charts, not just the chart that requires correction. |
| Chart Boundaries | Turn on Chart Boundaries to display chart boundaries on the Chart View. The dotted lines of a chart boundary indicate an area that contains a different map. Use the Joystick to move the cursor within a chart boundary, and press the +ZOOM key to see a closer view of the chart. |



NOTE: There are also alarm and display options that are exclusively available for Navionics charts. See **Navigation Alarms Overview** and **Customize the Chart View** for more information.

2D Chart View [Navionics]

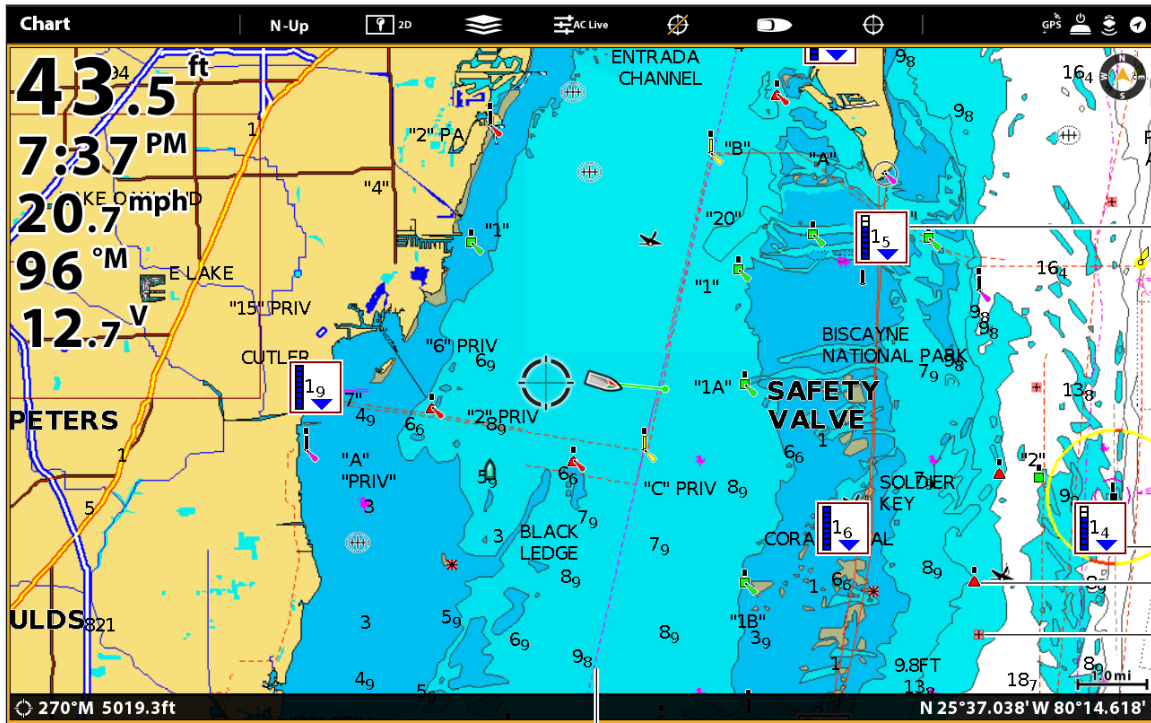

chart boundary

dynamic tides/currents icon

symbols

AutoChart Live

AutoChart LIVE can be used when Humminbird CoastMaster, Humminbird LakeMaster or Navionics is set as the map source. AutoChart LIVE uses data from an installed GPS receiver and 2D transducer (down beam, digital CHIRP or single-frequency DualBeam PLUS or DualSpectrum sonar) to create detailed depth maps of your favorite waters.

See the *AutoChart Live Overview* section in this manual for complete details about this feature.

2D Chart View (Humminbird LakeMaster with AutoChart Live Overlay)

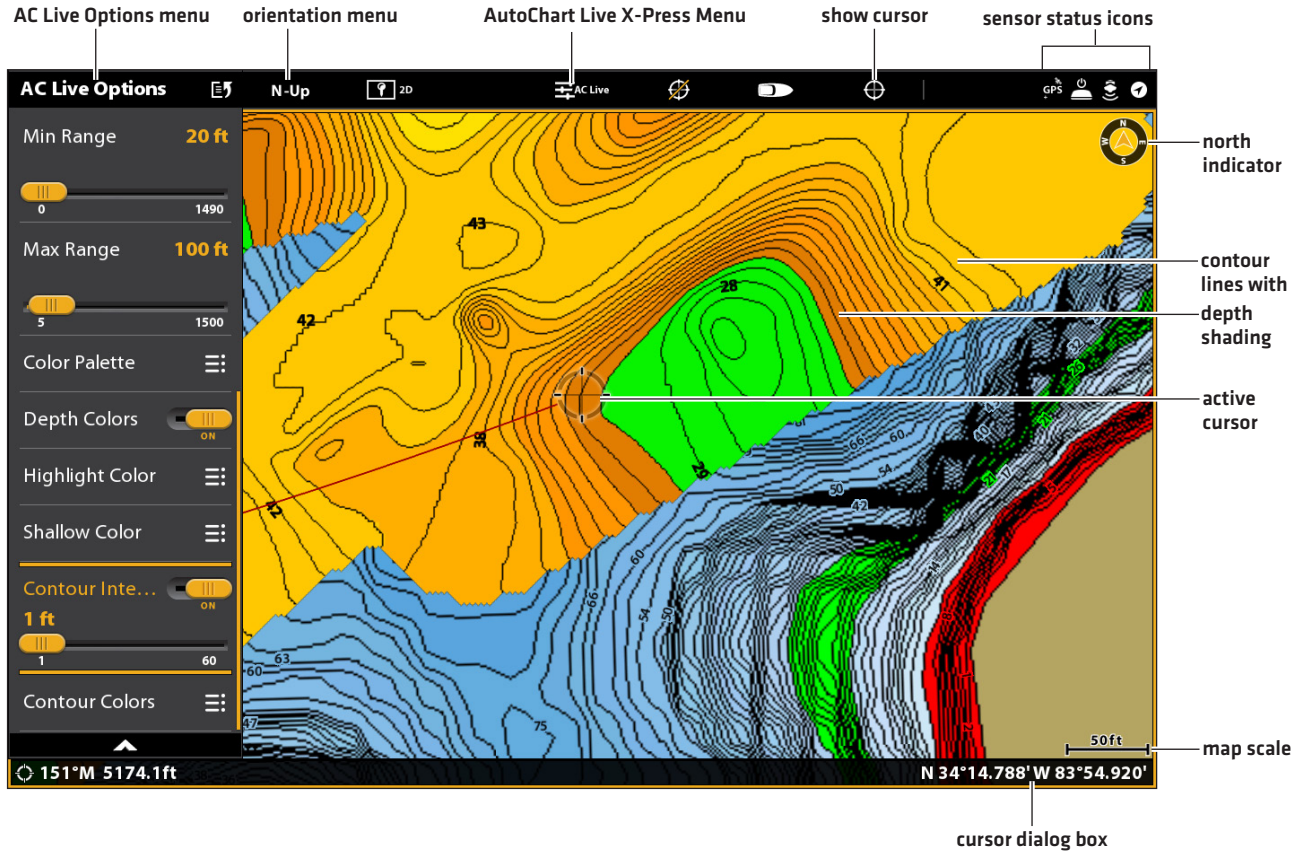

Using Chart Cards

When you install an SD or microSD chart card (separate purchase required), the control head automatically chooses the best map to display. If you install more than one SD or microSD card, you can choose which map source you want to use.

Your control head may be compatible with an SD or microSD card (depending on your control head model). Locate the instructions to install your SD card below and proceed to **Change the Map Source**.

Insert an SD Card

If your control head is compatible with SD cards, use the following instructions to install and eject it from the control head. If your control head is compatible with microSD cards, proceed to the next section below.

1. Insert the card into the slot with the label facing left.
2. The control head automatically chooses the best chart to display. If more than one type of SD card is installed, follow the on-screen prompts to select the map source.
3. **Remove:** Press the SD card into the slot and then release it. Pull the card from the slot.

Insert a microSD Card

1. Remove the microSD card slot cover.
2. Position the microSD card so that the label faces up.
3. Insert the card into the slot until it clicks into place.
4. Replace the slot cover so it is secure.
5. **Remove:** Press the card into the slot and then release it. Pull the card from the slot.



WARNING! Do not leave the SD slot cover open. The slot cover should always be closed to prevent water damage to the unit.

Change the Map Source

When you install an SD card, the map source is changed automatically to match the SD card map source. You can also change the map source using the Settings tool.

When you change the map source, the menu options for the Chart Views also change, allowing you to add navigation data, shading, alarms, and more. See each section for details.

1. Press the HOME key.
2. Select Settings.
3. Select Chart.
4. Select a Map Source. See **Using Built-in Charts**.

Global: Turn Global on to share the map source with the other control heads in the network.

Chart Settings

Humminbird Chart Cards with VX Technology have additional Chart Settings available. Set the following menus to your preference:

| | |
|--|--|
| Humminbird: Chart Card Info | Select this menu to review the information about the installed Humminbird chart card. |
| Water Level Offset | <p>Adjust the setting to change the water level read by the control head. For example, if the lake is down 5 feet, set the Water Level Offset setting to -5. The displayed numbers on the Contour Lines will adjust from the Water Level Offset setting, and the water level offset will be highlighted in brown to extend the land visually on the display.</p> <p>To apply depth colors, depth highlight range, etc., go to the Chart X-Press Menu > Chart Options > Humminbird Settings. See <i>Customize the Humminbird Chart Display</i> for more information.</p> |
| Dynamic Tides/ Currents | <p>Turn on Tides and Currents to review information for the nearest tide and current stations to your present position.</p> <p>*CoastMaster chart card required</p> |
| Text Size | Adjust the setting to change the size of font used in the Basemap. |
| Symbols | <p>Adjust for International or U.S. symbols.</p> <p>* Humminbird Chart Card with VX technology required</p> |
| Symbol Size | Adjust the setting to change the size of the symbols used in the Basemap. |
| Safe Depth | <p>Select this menu to set the minimum depth level for your vessel and to turn on highlights for hazards shallower than that level.</p> <p>* Humminbird Chart Card with VX technology required</p> |

Selecting a Map Source

selected category

return to Home screen

close

sensor status

Settings

Chart

CHIRP Sonar

When Global is On, this unit uses the global Chart Source. Setting Global to Off allows this unit to use an independent Chart Source.

select chart — **Chart**

Global

Navigation

Radars

General

My Vessel

Network

Simulation

Restore Defaults

Chart Source

Humminbird

Navionics

Humminbird Charts

VX Chart Cards

Legacy Chart Cards

VX Chart Settings

Humminbird: Chart Card Info

Basemap Software v1.031

Water Level Offset 0 ft

map source options

chart card types

menu options are determined by the selected map source



Tap to Select

OR

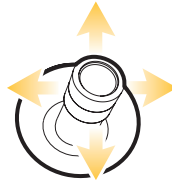

Select



Confirm

NAVIGATION ALARMS

When an alarm is turned on, an alert will sound or display on the control head to indicate the threshold has been exceeded. The settings in this section describe how to turn on a Navigation alarm, adjust the threshold, and display the limits on the view if they are available. The alarm options are determined by the map source.

 **NOTE:** To turn on additional alarms that relate to your vessel and navigation, such as Lost Heading, Drift Alarm, Pitch, Roll, and more, select Home > Alarms > System and Home > Alarms > Vessel.

Chart View with Alarm Overlays Displayed (Humminbird LakeMaster)



Off Course (XTE) Alarm

Turn on Off Course [XTE] to receive an alert if the vessel has traveled outside the selected route. You can also set how far the vessel is allowed to move off course before the alarm is triggered. If the alarm is turned off, the Off Course limit can be displayed on the Chart View, but you won't receive an alert if the vessel crosses it.

Turn on the Alarm

1. Press the HOME key.
2. Select Alarms > Navigation.
3. Select Off Course [XTE]. Tap the on/off button, or press the ENTER key, to turn it on.

Adjust the Parameters (optional)

1. Press the HOME key.
2. Select Settings > Navigation > Off Course [XTE].
3. Press and hold the slider, or press and hold the ENTER key, to set the amount the vessel can move off course.

Display the Off Course (XTE) Limit (optional)

1. With a Chart View displayed on-screen, tap Chart in the status bar, or press the MENU key.
2. Select Chart Options > Overlays > Nav Data.
3. Select XTE Limits.
4. Tap the check box, or press the ENTER key, to add a check mark and make it visible on the view.

Arrival Alarm

Turn on Arrival to receive an alert when the vessel has reached the destination waypoint, route point, or track point. You can also set the Arrival Radius to indicate how close to the destination point the alarm is triggered. If this alarm is turned off, the Arrival Radius will be displayed on the Chart View, but you won't receive an alert if the vessel crosses it.

The Arrival Radius also influences navigation. If the Arrival Radius is set to 60 feet from the destination point, the arrival is accomplished at 60 feet from the destination point. If there is another point in the route, navigation will then start to the next point.

Turn on the Alarm

1. Press the HOME key.
2. Select Alarms > Navigation.
3. Select Arrival. Tap the on/off button, or press the ENTER key, to turn it on.

Adjust the Parameters (optional)

1. Press the HOME key.
2. Select Settings > Navigation > Arrival Radius.
3. Press and hold the slider, or press and hold the ENTER key, to adjust the radius.

Waypoint Avoidance Alarm

Turn on Waypoint Avoidance to receive an alert if the vessel has crossed the Waypoint Avoidance Radius. If the alarm is turned off, the Waypoint Avoidance Radius can be set for a waypoint, and it will be displayed on the Chart View, but you won't receive an alert if the radius is crossed.

Turn on the Alarm

1. Press the HOME key.
2. Select Alarms > Navigation.
3. Select Waypoint Avoidance. Tap the on/off button, or press the ENTER key, to turn it on.

Create an Avoidance Waypoint

1. See *Waypoints: Set the Waypoint Radius and Avoidance* to identify a waypoint for avoidance.

Anti-Collision Alarm

If Navionics is selected, and the Anti-Collision alarm is turned on, an alert will be provided based on potential dangers detected in the chart data ahead of the vessel, such as land, rocks, and restricted areas. You can also select Anti-Collision Objects and how far in front of the vessel the area will be scanned based on distance or time.



NOTE: Navionics must be selected as the map source to enable this feature.

Chart View with Anti-Collision Overlay Turned On (Navionics)

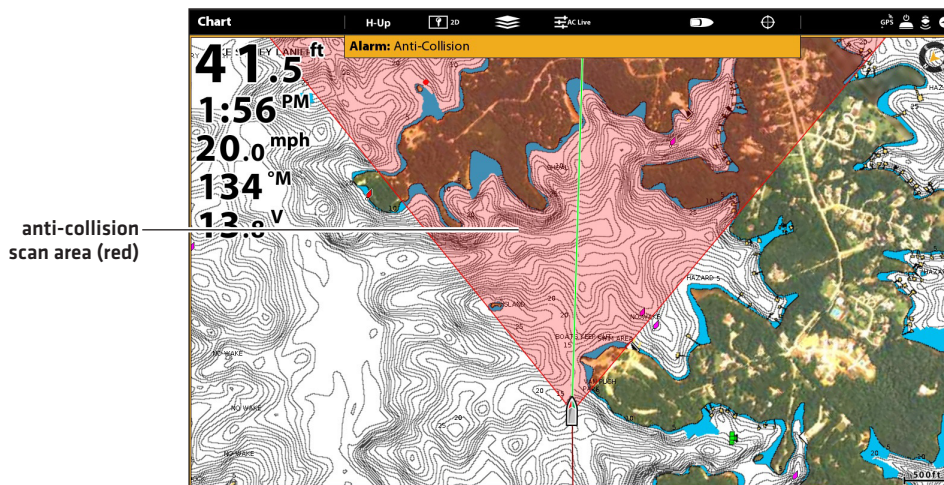

Turn on Anti-Collision

1. Press the HOME key.
2. Select Settings > Navigation.
3. Select Anti-Collision. Tap the on/off button, or press the ENTER key, to turn it on.

Use the Anti-Collision default settings, or use the menus in this section to set how the area is searched (Search Parameters, Search [Time] or Search [Distance], and Anti-Collision Objects).

Turn on the Alarm

1. Press the HOME key.
2. Select Alarms > Navigation.
3. Select Anti-Collision Alarm. Tap the on/off button, or press the ENTER key, to turn it on.

Display the Anti-Collision Overlay

When the overlay is turned off, the scan area is shown only when a danger is detected.

When the overlay is turned on, the scan area is displayed at all times. When a potential danger is detected, the scan area will turn red.

1. With a Chart View displayed on-screen, tap Chart in the status bar, or press the MENU key.
2. Select Chart Options > Overlays > Vessel.
3. Select Anti-Collision.
4. Tap the check box, or press the ENTER key, to add a check mark and make it visible on the view.

MAN OVERBOARD (MOB) NAVIGATION

As soon as you know that you have a man overboard (MOB), you should activate Man Overboard navigation to maximize the chances for a successful rescue. Man Overboard navigation marks the approximate point where the person went overboard and starts continuous navigation toward the Man Overboard waypoint.

Activate Man Overboard Navigation



1. Press and hold the MARK/Man Overboard key.

Man Overboard Navigation (in progress)

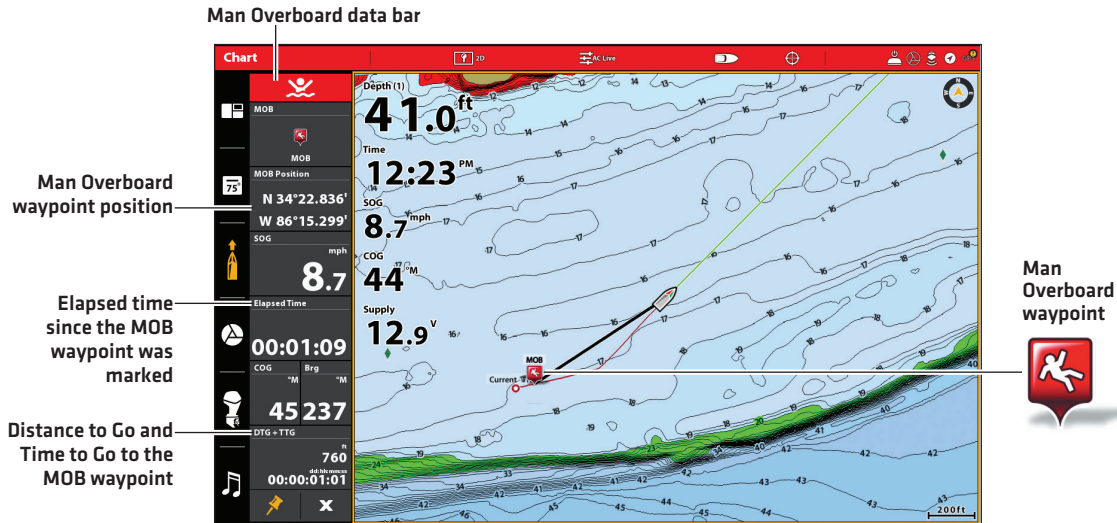

When Man Overboard is activated, any current navigation will be canceled and the current route will be discarded without notification. Man Overboard navigation will begin immediately, and you will see the following on the screen:

Chart View: The view will switch to Chart View automatically.

Man Overboard Waypoint: A waypoint is created at the vessel's current position, regardless of whether the chart cursor is active or not.

Continuous Navigation: The control head will begin continuous navigation toward the Man Overboard waypoint.

Auto Zoom: The screen magnifies to show the Man Overboard waypoint and the vessel on the screen.

Data Bar: The data bar will display digital readouts for Man Overboard, including the Man Overboard Waypoint latitude/longitude position, the elapsed time since Man Overboard was activated, and the Distance to Go and Time to Go to the MOB waypoint [DTG + TTG].

Cancel Man Overboard Navigation

1. Press and hold the MARK/Man Overboard key. Select Cancel Navigation.

OR

Press the GO TO key. Select Cancel Navigation.

CUSTOMIZE THE CHART VIEW

The settings in this section are optional. You can use the default settings for the chart appearance and map source, or you can customize the Chart View for your navigation preferences. See **Views** for more information.

Display Chart Layers and Overlays

Display overlays on the Chart view to add more details and data.

Displaying Humminbird Overlays

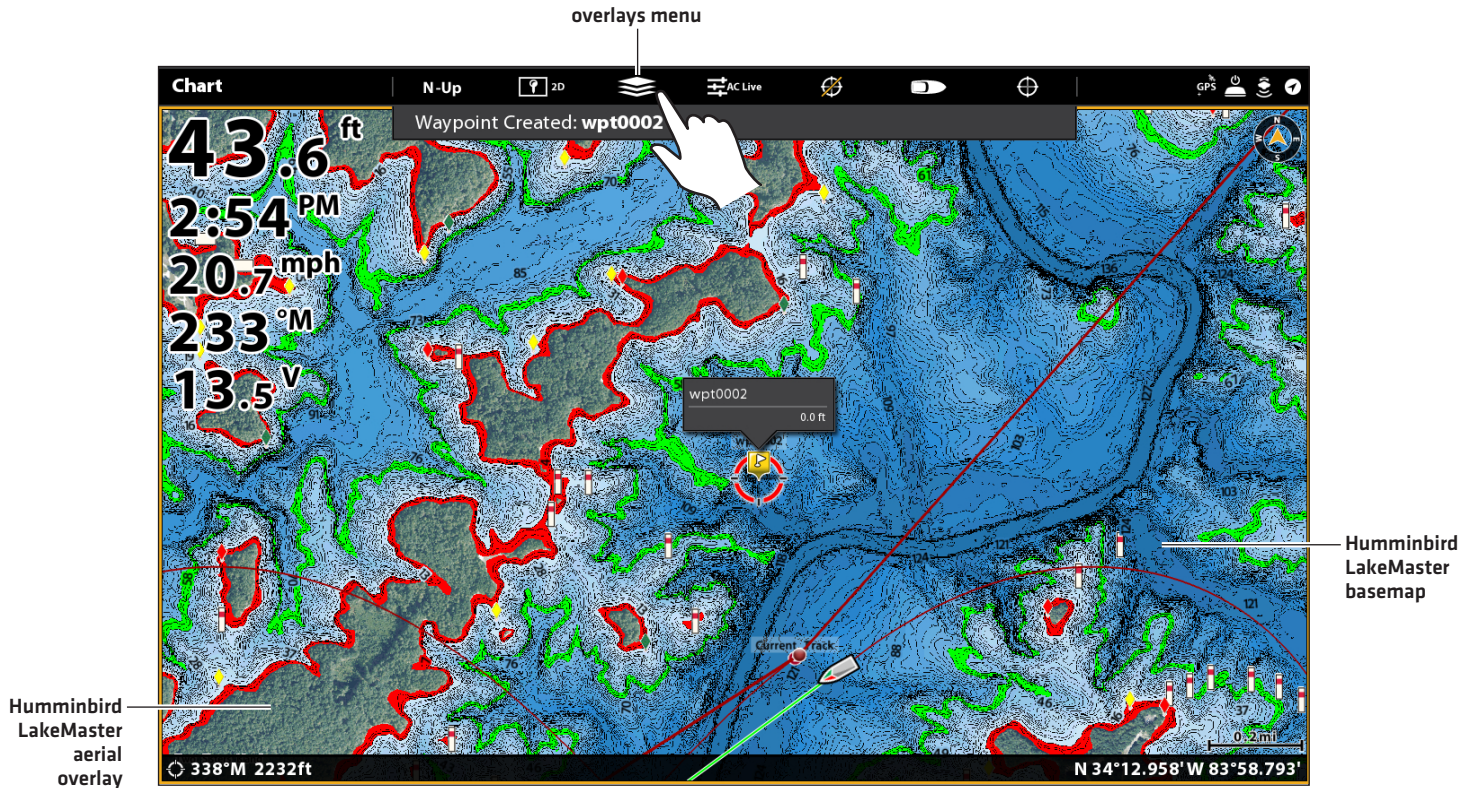

Tap to Open and Select

Display an Overlay

Choose between Humminbird and Navionics.

With those locations, you just have Satellite Maps [ON], 100%, and Land highlighted. The zoom level has to be less than 2 miles.

1. **Open the Layers Menu:** Tap the Layers Menu icon in the task bar.
2. Select Humminbird or Navionics.
3. **Humminbird:** Select Map Overlay or Base Layer. Select 2D Map, AutoChart, or SI Mosaic.

Navionics: Select Satellite Maps, Land, Land + Shoals, or Land + Sea.

| Humminbird Satellite Overlay Options | |
|--------------------------------------|--|
| 2D Map | Select 2D Map to display |
| AutoChart | Select AutoChart |
| Land + Shoals | Select Land + Shoals to display the satellite layer over land and shallow water. |
| Land + Sea | Select Land + Sea to display the full satellite layer. |

| Navionics Satellite Overlay Options | |
|-------------------------------------|--|
| Satellite Maps | Select Satellite Maps |
| Land | Select Land to display the satellite layer over land only. |
| Land + Shoals | Select Land + Shoals to display the satellite layer over land and shallow water. |
| Land + Sea | Select Land + Sea to display the full satellite layer. |

Displaying Humminbird Overlays

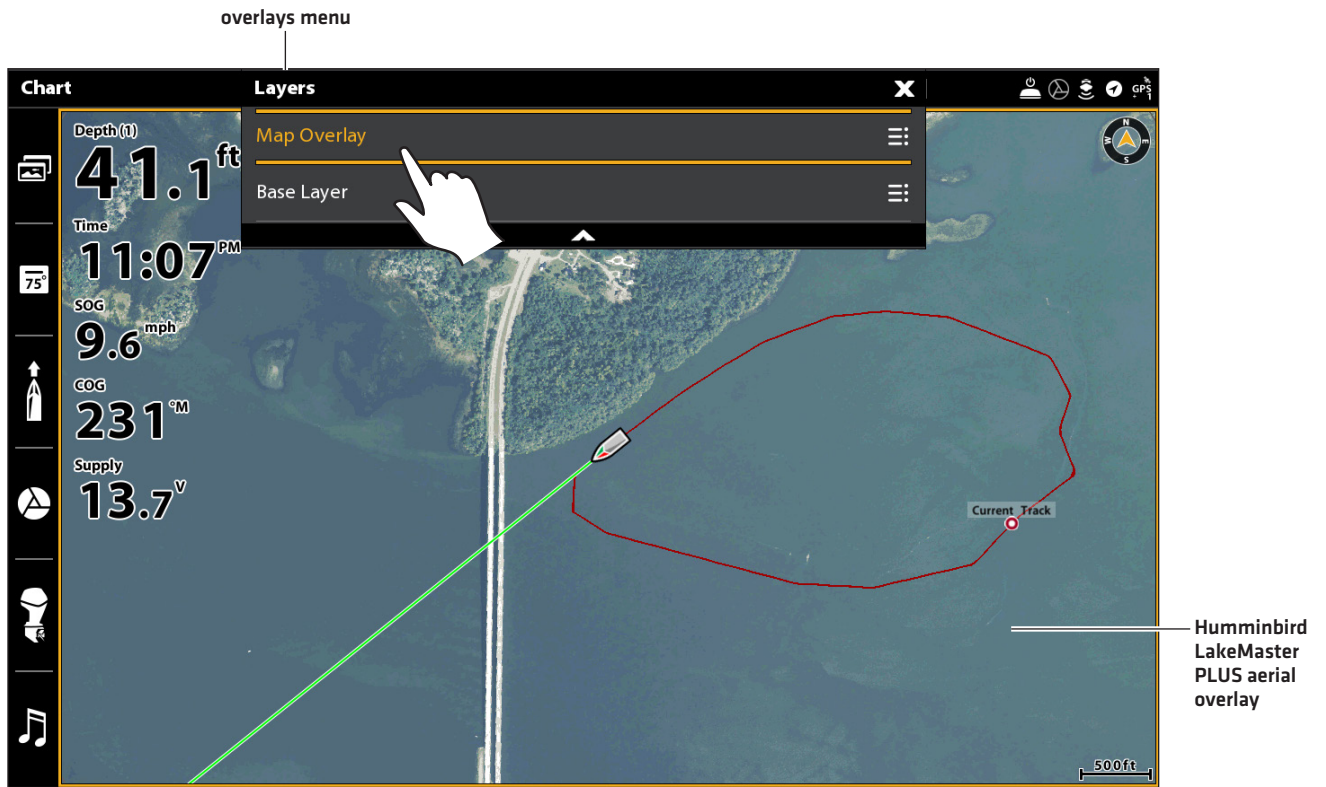

Tap to Open and Select

Customize the Humminbird Chart Display (optional)

Humminbird must be selected as the map source to enable the following features. The menu options will be different for Humminbird Chart Cards with VX Technology and Humminbird Legacy Chart Cards.

Humminbird Chart Cards with VX Technology

When Humminbird is selected as the map source, additional menus to customize the Humminbird chart display are added to the menu system.

Select a Chart Preset

Use Chart Presets to quickly alternate between settings. You can use the default Fishing or Navigation settings provided, or you can create a custom User preset with your preferences. The Fishing and Navigation presets are also fully customizable. You can restore each preset to its default settings at any time.

1. Press the MENU key.
2. Select Chart Options.
3. Select a Chart Preset.



QUICK TIP! You can also change this setting by tapping the chart preset icon in the status bar.

Selecting a Chart Preset

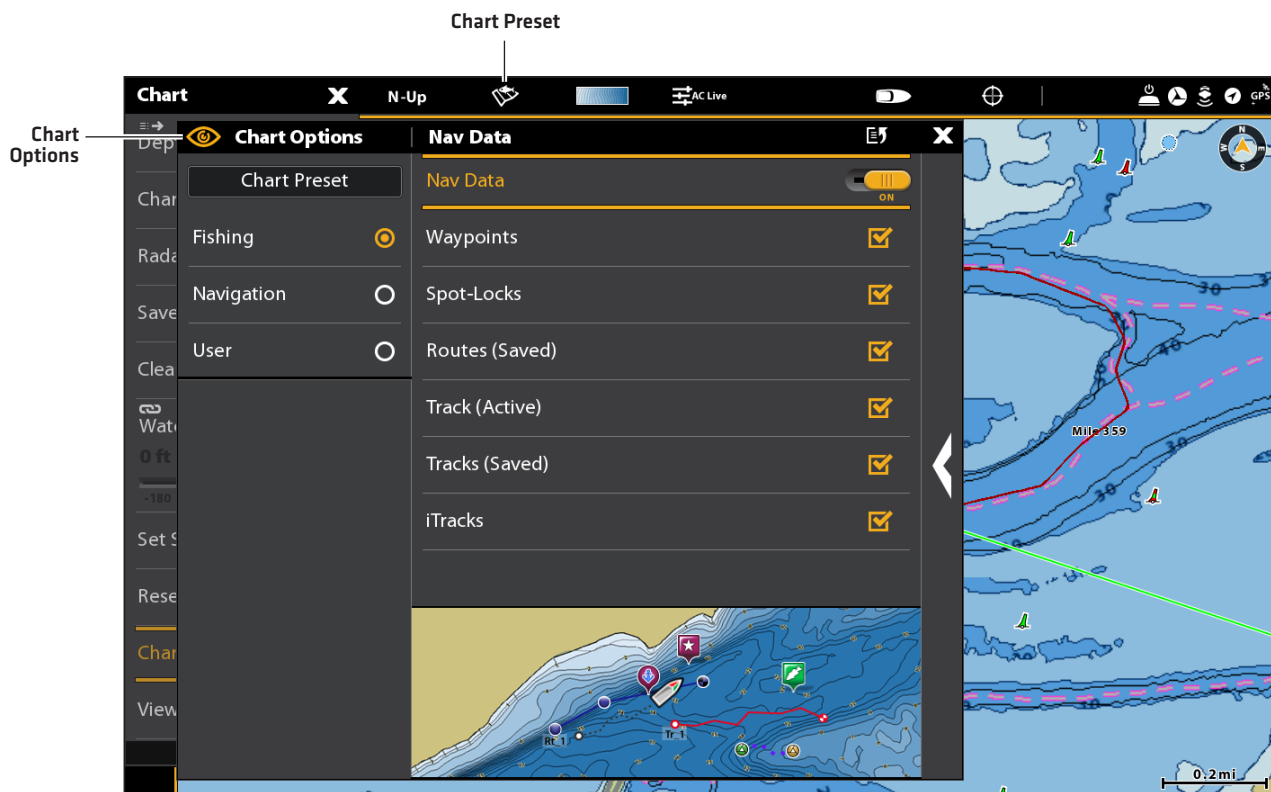

Display Contour Lines and Depth Colors

You can display or hide contour lines, highlight shallow water, and highlight a depth range on the map.

1. With a Chart View displayed on-screen, tap Chart in the status bar, or press the MENU key once.
2. Select Chart Options.
3. Select Depths/Contours.
4. Select the following menus to your preference.

| | |
|------------------------------|--|
| Contour Lines | Turn on Contour Lines to display contour lines on the map. |
| Contour Density | Use Contour Density to adjust the density of the contour lines displayed on the map. You can set the density to High, Medium, or Low. Contour lines must be turned on to adjust this feature. Contour density can only be customized in the Fishing and User presets. Navigation contour density cannot be changed. |
| Depth Palette | Turn on Depth Palette to turn on depth area colors in the Chart View. |
| Palette Min/Max Range | You can adjust the range of data shown on the chart by changing the minimum range and maximum range on the display. The range you select affects how the depth colors are displayed. For best results, set a narrow depth range threshold. For example, set the Palette Min Range to 100 and the Palette Max Range to 200. |
| Color Palette | Use Color Palette to change the colors used to display the map. You can also change this setting by tapping the color palette icon in the status bar. |

Set Depth Highlights

1. With a Chart View displayed on-screen, tap Chart in the status bar, or press the MENU key once.
2. Select Chart Options.
3. Select Depths Highlights.
4. Select the following menus to your preference.

| | |
|---------------------------------------|--|
| <p>Depth Highlight</p> | <p>Turn on Depth Highlight to highlight a depth setting in the Chart Views. The depth you set will be highlighted in the color selected. You can set up to four depth highlights.</p> |
| <p>Highlight Range</p> | <p>When a Depth Highlight is active in the Chart Views, use Highlight Range to highlight a range on each side of the highlighted depth. For example, if you know a certain fish is holding at 18 to 20 feet, you can set the Depth Highlight at 19 feet, and the Highlight Range a +/- 1 foot. The view will show a green band from 18 to 20 feet.</p> |
| <p>Shallow Water Highlight</p> | <p>Turn on Shallow Water Highlight and adjust the slider. When the depth is equal to or less than the amount set, it will be highlighted in red [or the color you select] in the Chart Views. For example, if your boat has a draft of 3 feet, set the Shallow Water menu to 3 feet, and the unit will draw a red band from 0 to 3 feet.</p> |

Adjusting the Vx Chart Card Display Settings

The screenshot displays the 'Chart Options' menu with the 'Depth Highlights' section expanded. The settings are as follows:

- Depth Highlights:** Toggled ON.
- Shallow Water Highlight:** Set to 10 ft, toggled ON.
- Color:** A red color swatch is selected.
- Depth Highlight 1:** Toggled ON.
- Min Range:** Set to 20 ft.
- Max Range:** Set to 30 ft.

On the right, a depth contour chart shows the visual result of these settings. Annotations include:

- depth palette colors:** Points to the various colored contour lines on the chart.
- depth highlight 1:** Points to a yellow highlight band on the chart.
- contour lines:** Points to the thin lines representing depth contours.
- shallow water highlight:** Points to a red highlight band at the bottom of the chart.
- depth label (depth of contour):** Points to a numerical label on a contour line.

Humminbird Legacy Chart Cards

When Humminbird is selected as the map source, additional menus to customize the Humminbird chart display are added to the menu system.

1. With a Chart View displayed on-screen, tap Chart in the status bar, or press the MENU key once.
2. Select Chart Options.
3. Select Humminbird Settings.
4. Select the following menus to your preference.

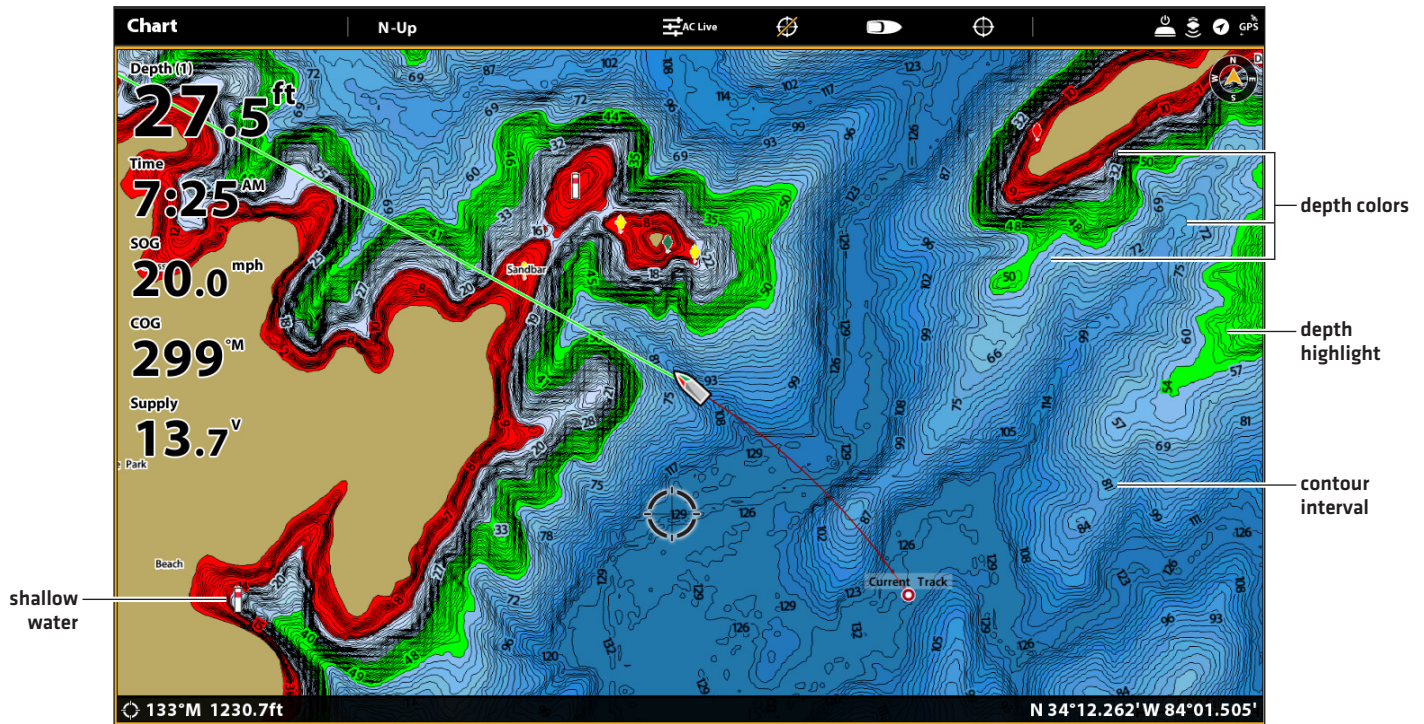

| | |
|------------------|---|
| Depth Colors | Turn on Depth Colors and adjust the range for depth shading in the Chart Views. |
| Depth Highlight | Turn on Depth Highlight to highlight a depth setting in the Chart Views. The depth you set will be highlighted in green. Use Depth Highlight with Highlight Range. |
| Highlight Range | When a Depth Highlight is active in the Chart Views, use Highlight Range to highlight a range on each side of the highlighted depth. For example, if you know a certain fish is holding at 18 to 20 feet, you can set the Depth Highlight at 19 feet, and the Highlight Range a +/- 1 foot. The view will show a green band from 18 to 20 feet. |
| Shallow Water | Turn on Shallow Water and adjust the slider. When the depth is equal to or less than the amount set, it will be highlighted in red in the Chart Views. For example, if your boat has a draft of 3 feet, set the Shallow Water menu to 3 feet, and the unit will draw a red band from 0 to 3 feet. |
| Contour Interval | Turn on Contour Interval to display lines at set intervals on the Chart View. Adjust the slider to set the distance between each line. Contour Interval is also affected by the Water Level Offset setting. See <i>Map Source: Using Built-in Charts</i> . |

Show/Hide Spot Soundings (Humminbird Basemap)

Spot Soundings are depth measurements shown on the chart. The available settings are determined by the installed map card and selected map source. Humminbird Basemap must be selected as the map source.

1. From the Humminbird Settings menu, select Spot Soundings.
2. Select On or Off.

Set the Chart Orientation

Humminbird Vx Chart Card

1. With a Chart View displayed on-screen, tap Chart in the status bar, or press the MENU key once.
2. Select Chart Options > General > Orientation.
3. Select an orientation to apply to the chart.

Legacy Chart Card

1. With a Chart View displayed on-screen, tap Chart in the status bar, or press the MENU key once.
2. Select Chart Options > Preferences > Orientation.
3. Select an orientation to apply to the chart.



QUICK TIP! You can also select the Chart Orientation Menu on the status bar. See the illustration below.

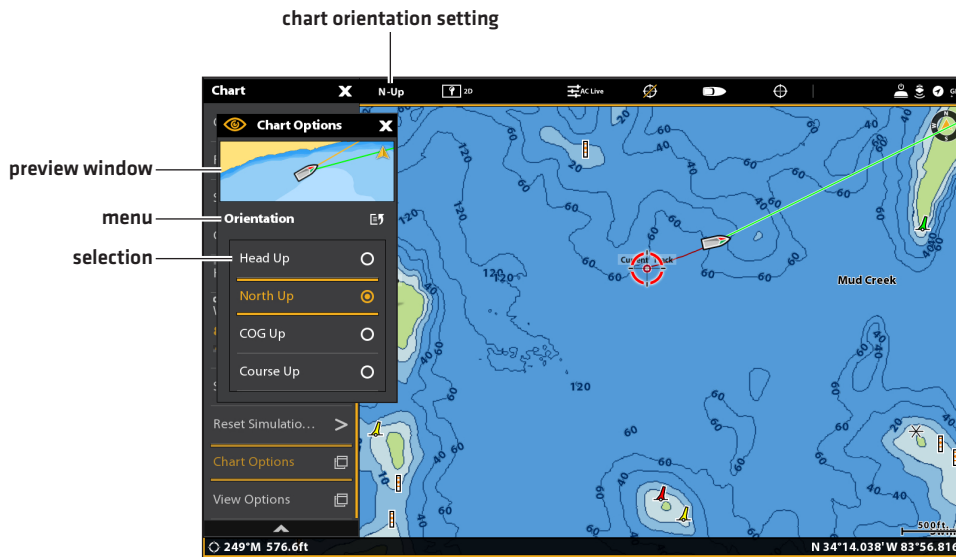

| | |
|---|---|
| <p>Head Up [compass or GPS required]</p> | <p>The vessel's current heading points up, and the chart rotates around the vessel icon so that it always points up on the view. The heading is provided by the connected compass/heading sensor. If a compass is not connected, the vessel will be oriented according to the COG [Course Over Ground].</p> |
| <p>North Up</p> | <p>The chart is oriented with North up on the display, and the vessel rotates according to its heading or COG [Course Over Ground].</p> |
| <p>COG Up</p> | <p>The chart is displayed with the vessel oriented in a fixed position pointing up, and the chart rotates according to the vessel COG [Course over Ground].</p> |
| <p>Course Up</p> | <p>During navigation, the intended course or route leg is shown at the top of the view. Objects ahead of the vessel are drawn above the vessel. When the vessel is not navigating, the current heading is displayed.</p> |

Set the Motion Mode

Motion Mode controls how the chart moves on the view. This menu is available in Custom Mode [see *The Menu System: Change the User Mode*].

Humminbird Vx Chart Card

1. With a Chart View displayed on-screen, tap Chart in the status bar, or press the MENU key once.
2. Select Chart Options > General > Motion Mode.
3. Select Relative or True.

Legacy Chart Card

1. With a Chart View displayed on-screen, tap Chart in the status bar, or press the MENU key once.
2. Select Chart Options > Preferences > Motion Mode.
3. Select Relative or True.

| | |
|-----------------|--|
| Relative | The position of the vessel is fixed on the view and the chart moves with the vessel. |
| True | The chart is fixed and the vessel moves towards chart objects on the view. |

Turn on/off Vessel Offset

Vessel Offset allows you to see more of the view based on the speed of the vessel. Vessel Offset works with Auto Shift Speed.

Humminbird Vx Chart Card

1. With a Chart View displayed on-screen, tap Chart in the status bar, or press the MENU key once.
2. Select Chart Options > General > Vessel Offset.
3. Select Off, On, or Auto.

Legacy Chart Card

1. With a Chart View displayed on-screen, tap Chart in the status bar, or press the MENU key once.
2. Select Chart Options > Preferences > Vessel Offset.
3. Select Off, On, or Auto.

| | |
|-------------|---|
| Off | The vessel is displayed in the center of the Chart View. |
| On | The vessel is displayed on the lower part of the Chart View. |
| Auto | When the vessel is moving below the Auto Shift Speed setting, the vessel icon will be displayed in the center of the view. When the vessel is moving at or above the Auto Shift Speed setting, the vessel icon will move to the edge of the view so that more of the view is shown on-screen. |

4. **Close:** Press the EXIT key until the menu is closed.
5. To change the Auto Shift Speed Setting, press the MENU key twice. Select My Vessel > Auto Shift Speed.

Turn on Auto Zoom

Auto Zoom focuses the view on the current route leg as it is being navigated. As the vessel's speed increases, the chart range will increase. If you press the ZOOM keys to see more or less of the view, Auto Zoom will pause.



NOTE: The Auto Zoom setting does not apply to the 3D Views.

1. Press the HOME key.
2. Select Settings.
3. Select Navigation.
4. Under Navigation Options, select Auto-Zoom. Tap the on/off button, or press the ENTER key, to turn it on.

Customize the Navionics Chart Display (optional)

Navionics must be selected as the map source to enable the following features.

Select Map Data

When a Navionics chart is selected as the map source, you can set nav aids, marine, and land icons to hidden or visible. The Depth menu option allows you to see shading on the map based on the set depth.

1. With a Chart View displayed on-screen, tap Chart in the status bar, or press the MENU key once.
2. Select Chart Options.
3. Select Navionics Settings.
4. Use the touch screen or the Joystick to select a menu and change the settings.

Chart View with Nav aids and Icons Displayed (Navionics)

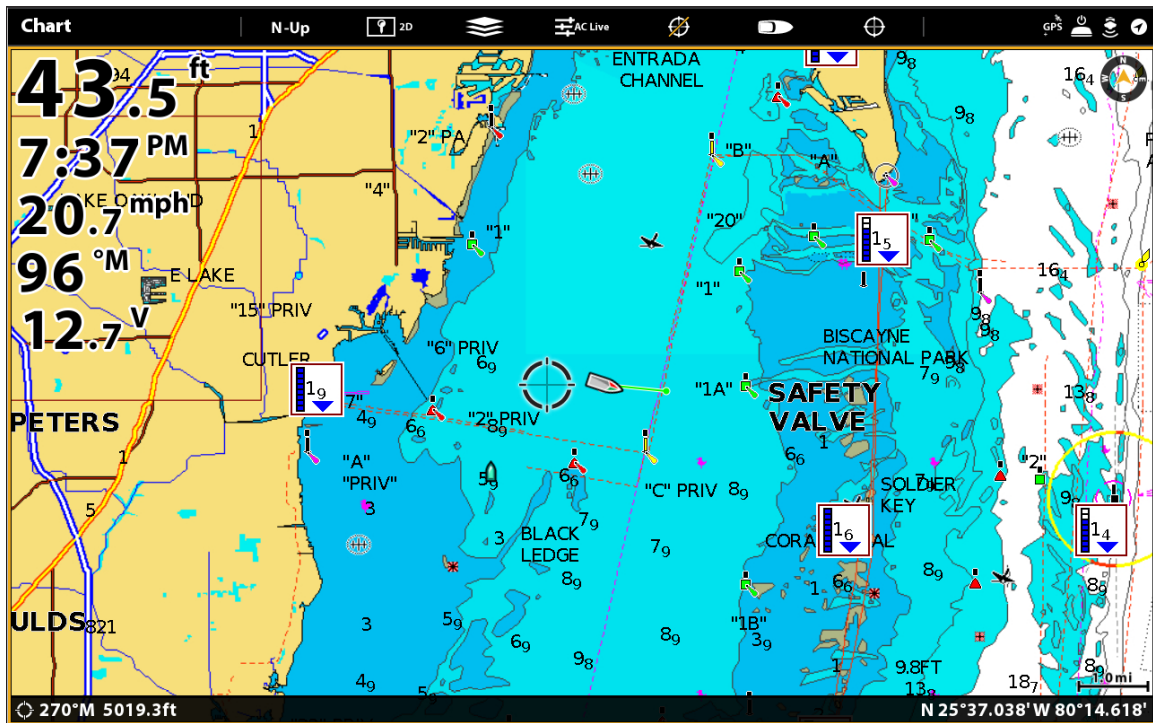

Change the Chart Mode

Use the instructions in this section to switch the Chart View from 2D to 3D.

Change the Chart Mode

Touch Screen

1. With two fingers, tap the screen twice.

OR

1. Tap Chart in the status bar.
2. Select Chart Mode.
3. Select a menu option.

Keypad

1. Press the MENU key.
2. Select Chart Mode.
3. Select a menu option.

CHANGE THE CHART VIEW DATA OVERLAYS

Use the Overlays menu to display or hide information on the view. In a Chart View, you can display or hide the vessel icon, navigation data [waypoints, routes, tracks], data overlays, AIS and MARPA targets, and range rings. The available menu options are determined by the accessories attached to the control head network. Also, see **Views** for more information about Overlays.

1. With a Chart View displayed on-screen, tap Chart in the status bar, or press the MENU key once.
2. Select Chart Options.
3. Select Overlays.
4. Use the touch screen or Joystick to select a menu and change a setting. [check mark = visible, blank = hidden].

Chart View with Overlays Displayed (Humminbird)



CHART AND RADAR

If a radar is connected to the control head network, the radar data can be displayed on the Chart View. To adjust the menu settings for the radar, see **Radar Overview** for more information.

Start Radar Transmission

1. **Humminbird CHIRP Radar:** Press the POWER key once. Select Radar > Standby. Press the POWER key again, and select Radar > Transmit.

Humminbird Radar: Press the POWER key once. Select Radar Transmit, and turn it on.



NOTE: For more information about Humminbird CHIRP Radar and Humminbird Radar, see **Radar Overview**.

Display Radar on the Chart View

1. With a Chart View displayed on-screen, tap Chart in the status bar, or press the MENU key once.
2. Select Radar.
3. Select Radar Overlay. Tap the on/off button, or press the ENTER key, to turn it on.



NOTE: You can also display Range Rings and MARPA Targets on the Chart View. See **Change the Chart View Data Overlays** in this section for more information.

Turning on the Radar Overlay



INTRODUCTION TO NAVIGATION

Your Humminbird control head allows you to mark waypoints, create a route, and start navigating. Waypoints, routes, and tracks can be managed on-screen so you can save your favorites, edit names, and easily return to your favorite destinations.

There are many ways to start navigation or edit navigation data with your Humminbird control head. The instructions in this section review navigation features on the Chart View. To use navigation features from the Nav Data tool, see *Manage your Navigation Data*.

 **NOTE:** To start navigation from your control head to your autopilot, see the autopilot section of this manual.

Chart View with Waypoints, Routes, Tracks



Tap to Activate the Cursor

OR

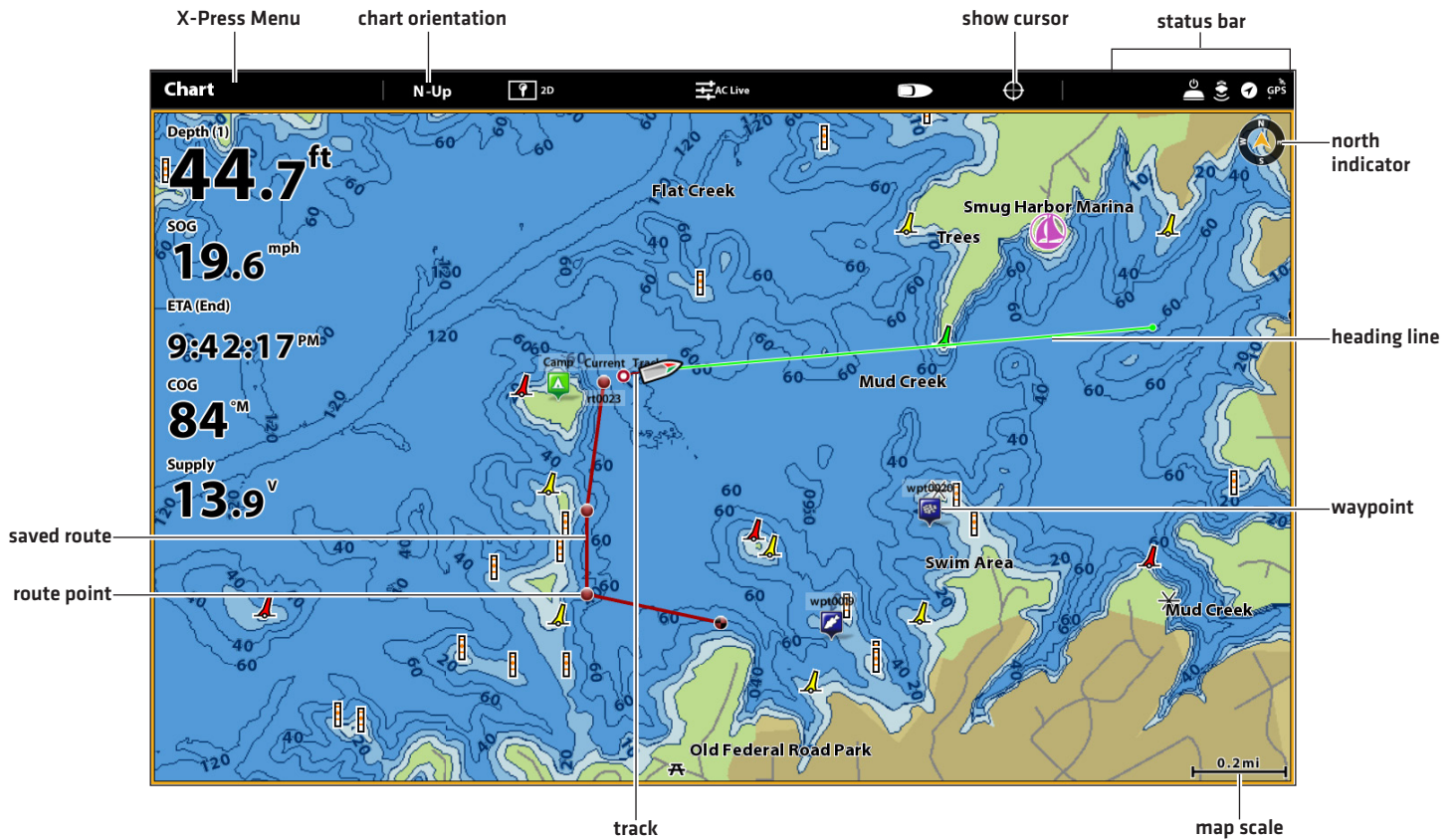
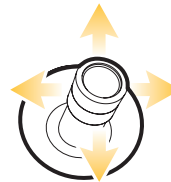

Move the Joystick to Activate the Cursor

NAVIGATION MENU OVERVIEW

There are many ways to use the navigation features on your control head. The Navigation X-Press Menu and Cursor menu are opened using the touch screen. The same menus are also opened by pressing the MARK key, GO TO key, or ENTER key.

This section is an overview of the menus available for navigation. The availability of menu options is determined by the navigation mode and your Humminbird model. To apply these functions, see **Waypoints**, **Routes**, **Tracks**, and **Search**.

Navigation X-Press Menu

The **Navigation X-Press Menu** allows you to open the following navigation menus: Mark, Go To, and Info. The Navigation X-Press Menu is only available in the Chart View, Sonar Views, or Radar View displayed on-screen with Navigation enabled.

Open the Navigation X-Press Menu

1. With a Chart View displayed on-screen, tap Chart in the status bar.
2. Select Mark, Go To, or Info.
3. Select an action from the submenu. For example, to mark a waypoint, select Mark > Waypoint.

Using the Touch Screen to Open the Navigation X-Press Menu

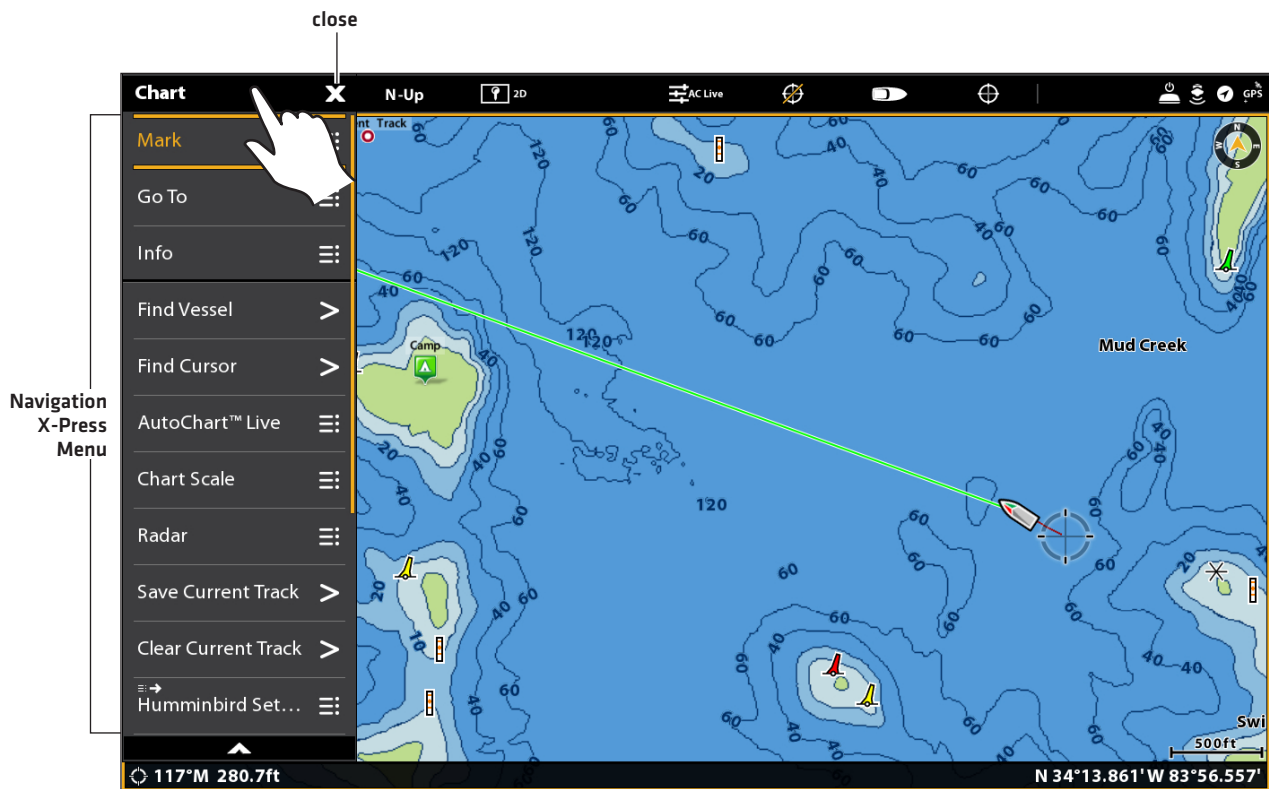

Mark Menu

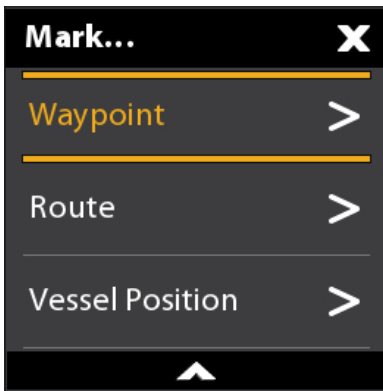

The **Mark menu** marks a waypoint at the selected location. You can also create a saved route or mark the vessel position. See **Waypoints** and **Routes** for more information about using this menu.

Open the Mark Menu

1. **Touch Screen:** Select Mark from the Navigation X-Press Menu.

OR

Keypad: Press the MARK key.

Mark Menu Options

| | |
|---|---|
| Waypoint | Select Waypoint to save a waypoint at the vessel position. If the cursor is active, the waypoint is saved at the cursor position. |
| Route | Select Route to create a saved route. See Routes for more information. |
| Lat/Long | Use the on-screen keyboard to manually enter a latitude/longitude position for a waypoint. |
| Vessel Position [with active cursor] | Select Vessel Position to save a waypoint at the vessel position even though the cursor is active. |

Go To Menu

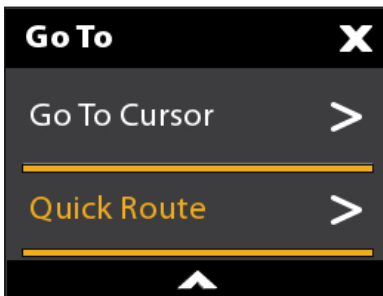

The **Go To menu** starts navigation to the item you select. See **Routes** for more information about using this menu.

Open the Go To Menu

1. **Touch Screen:** Select Go To from the Navigation X-Press Menu.

OR

Keypad: Press the GO TO key.

| Go To Menu Options | |
|---------------------------|---|
| Quick Route | Select Quick Route to mark quick route points and start navigation. See Routes for more information. |
| Nav Data | Open the Nav Data tool to select saved navigation data and start navigation. |
| Lat/Long | Open the on-screen keyboard to enter a latitude/longitude position. Select Go To to start navigation to the position. |
| Go To Cursor | If the cursor is active, navigation will start to the cursor position. |

When the Go To menu is opened during navigation, additional menu options are available, including the following:

| Go To Menu Options (during navigation) | |
|---|---|
| Cancel Navigation | Select Cancel Navigation to cancel navigation with the control head. |
| Restart Course | Select Restart Course to start navigation from the current vessel position instead of from the first route point. The control head will recalculate navigation to the next closest point in the route. This is helpful if the boat has navigated off course from the current route. |
| Next Point | Select Next Point to skip the current point and navigate to the next route point in the route. |
| Reverse Route | Select Reverse Route to reverse the currently navigated route. Navigation will start from the vessel position and continue in the opposite order. |

Info Menu

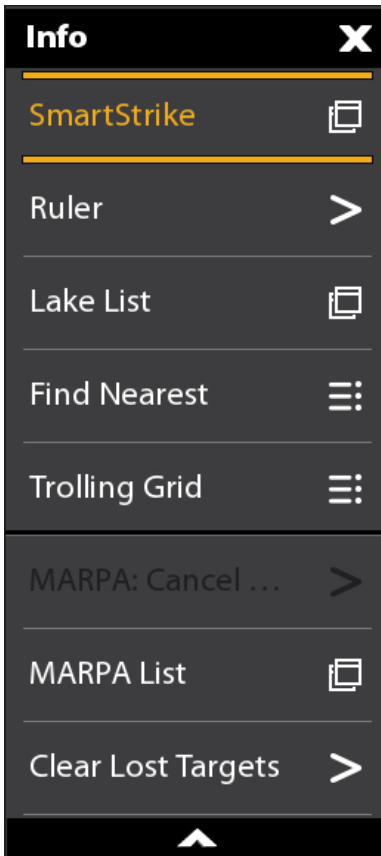

Use the **Info menu** to start a proximity search. You can also set a trolling grid from this menu.

If you are using Humminbird as the map source, you can search lake information. Navionics also has additional search options.

If you have Radar and AIS attached, use this menu to search targets [See **Radar Overview, AIS and MARPA**].

Open the Info Menu

1. **Touch Screen:** Select Info from the Navigation X-Press Menu.

OR

Keypad: Press the ENTER key.



NOTE: If you select a waypoint, route, or track with the cursor, and then press the ENTER key, the Info menu for the selected item will display.

| Info Menu Options | |
|----------------------------|---|
| Info | Select Info to search the area within a preset range for a variety of data, including cautions, tide stations, current stations, and ports. The available information is determined by the selected map source and the information available in the search area. See Search for more information. [Navionics only] |
| Ruler | Select Ruler to measure the distance between two positions on the view. Press the ENTER key to select the measurement start point. Move the Joystick to the second selected position, and press the ENTER key to mark the measurement end point. |
| Lake List | Select Lake List to search for lakes within a preset range. Humminbird must be selected as the map source. See Search for more information. |
| Lake Name | Select Lake Name to open the on-screen keyboard and search for a lake by name. Humminbird must be selected as the map source. See Search for more information. |
| Find Nearest | Select Find Nearest to search the closest waypoints, routes, and tracks within a preset range. See Search for more information. |
| Trolling Grid | Select Trolling Grid to apply a trolling grid to a position on the Chart View. See Waypoints for more information. |
| AIS: All Inactive | Select this menu to change all tracked AIS targets to inactive [see AIS and MARPA]. |
| AIS List | Select this menu to display a list of all AIS targets within the AIS transmission range [see AIS and MARPA]. |
| MARPA: All Inactive | Select this menu to cancel all MARPA targets [see AIS and MARPA]. |
| MARPA List | Select this menu to display a list of all MARPA targets [see AIS and MARPA]. |
| Clear Lost Targets | Select this menu to clear the list of lost targets from view. |

Cursor Menu

The **Cursor menu** is another way to use the touch screen and mark a waypoint, create a route, or start a search. The Cursor menu is only available with the 2D Chart View, Sonar Views, or Radar View displayed on-screen.

Open the Cursor Menu

1. Press and hold a position on the Chart View.

Displaying the Cursor Menu

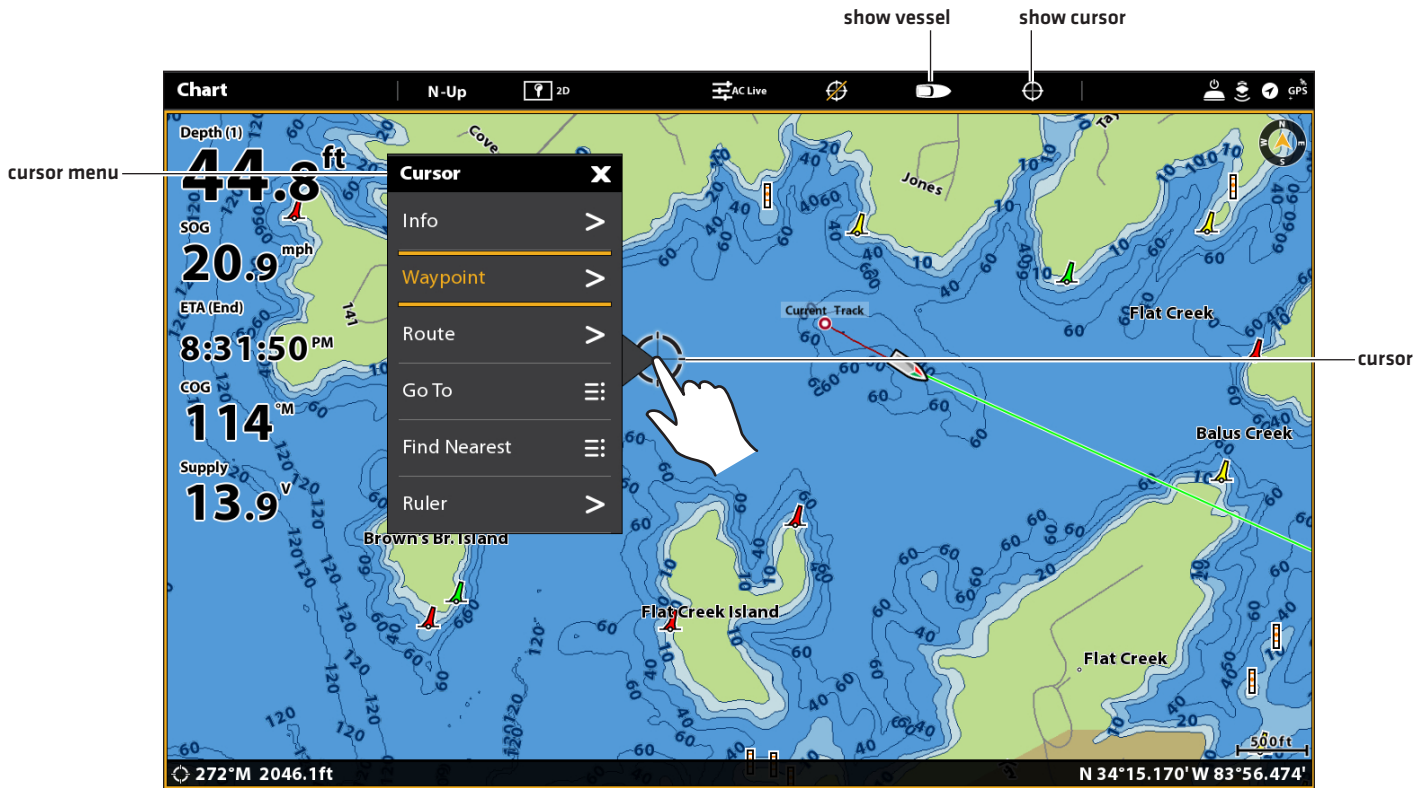

Press and Hold

WAYPOINTS



Waypoints are saved latitude/longitude positions. They mark a position of interest such as your favorite fishing area, structure, or marker buoy. The control head saves the position and allows you to edit the waypoint name, icon, and more [see *Manage your Navigation Data*]. You can save 10,000 waypoints to the control head.

Mark Waypoints

Waypoints can be marked at the vessel position or cursor position. To edit the waypoint, see *Edit a Waypoint in the Chart View* or *Manage your Navigation Data*. To display waypoints on the chart as they are marked, see *Change the Chart View Overlays*.

Mark a Waypoint at the Vessel Position

Touch Screen

1. Tap Chart in the status bar.
2. Select Mark.
3. Select Waypoint.
4. The Favorites menu will be displayed so you can edit the waypoint using the options you set in Favorite Settings.

Keypad

1. Press the MARK key twice.
2. The Favorites menu will be displayed so you can edit the waypoint using the options you set in Favorite Settings.

Mark a Waypoint at the Cursor Position

Touch Screen

1. Press and hold a position on the Chart View.
2. Select Waypoint.
3. The Favorites menu will be displayed so you can edit the waypoint using the options you set in Favorite Settings.

Keypad

1. Use the Joystick to move the cursor to a position on the chart.
2. Press the MARK key twice.
3. The Favorites menu will be displayed so you can edit the waypoint using the options you set in Favorite Settings.

Marking a Waypoint at the Cursor Position

The Mark menu opens when you press the MARK key or select Mark from the Navigation X-Press Menu.



Press and Hold

OR

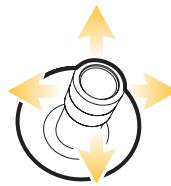

Move the Joystick
to Activate the Cursor



Press the
MARK key Twice

Quick Mark Waypoints (on the go)

If you set the Mark Mode to Quick Mark, the waypoint name and icon is automatically assigned based on the Quick Mark Settings. The waypoint can be edited at a later time. See **Manage your Navigation Data** for more information.

1. Press the HOME key.
2. Select the Nav Data tool.
3. Under Options, select Waypoints.
4. Select Mark Mode > Quick Mark.
5. Close the Nav Data tool and display a Chart View on-screen.

When you mark a waypoint, the waypoint name and icon will be automatically assigned.

Mark + Edit Waypoints (on the go)

If you set the Mark Mode to Mark + Edit, you can edit a waypoint immediately when you mark it in the Chart View. See **Manage your Navigation Data** for more information.

1. Press the HOME key.
2. Select the Nav Data tool.
3. Under Options, select Waypoints.
4. Select Mark Mode > Mark + Edit.
5. Close the Nav Data tool and display a Chart View on-screen.

When you mark a waypoint, the Waypoint Info menu will be displayed so you can edit the waypoint.

Move a Waypoint in the Chart View

1. Use the Joystick to move the cursor to a waypoint on the chart.
2. Press the ENTER key.
3. Select Move.
4. The menu will close. Use the Joystick to move the waypoint to a new position.
5. Press the ENTER key to confirm the new position.

Edit a Waypoint in the Chart View

1. Tap the waypoint icon to select it. Tap the Waypoint Name.

OR

Use the Joystick to move the cursor to a waypoint icon. Press the ENTER key.

2. Use the Waypoint Info menu to edit the waypoint name, icon, color, and more (see *Manage your Navigation Data* for more information).

3. **Close:** Press the EXIT key.

Editing a Waypoint on the Chart View



Create a Depth Marker

To save depth information with a waypoint, mark the waypoint at the vessel position. If the waypoint is marked at the cursor position, the depth information will not be available, but you can enter a depth manually. When Depth Marker is turned on, the Depth Marker icon is displayed on the Chart View.

1. Tap Chart in the status bar. Select Mark > Waypoint.

OR

Press the MARK key twice.

2. Select the Waypoint icon on the Chart View.

3. Press the ENTER key.

4. Select Depth Marker. Tap the on/off button, or press the ENTER key, to turn it on.

To change a depth marker back to a waypoint icon, turn off Depth Marker.



NOTE: If the waypoint was marked at the cursor position, select Full Info > Edit Depth. Use the on-screen keyboard to enter a depth. If you turn on Depth Marker, the depth you enter will be displayed.

Set the Waypoint Radius and Avoidance

A radius can be set around a selected waypoint. If you select Avoidance, the radius will be highlighted around the waypoint. To receive an alarm when the waypoint avoidance radius has been crossed, turn on the Waypoint Avoidance Alarm [see [Navigation Alarms Overview](#)].

1. Tap the waypoint icon to select it. Tap the Waypoint Name.

OR

Use the Joystick to move the cursor to a waypoint icon. Press the ENTER key.

2. Select Full Info.
3. Select Radius, and turn it on.
Press and hold the slider, or press and hold the ENTER key, to adjust the radius setting.
4. To set the waypoint to avoidance, select Avoidance. Tap the check box, or press the ENTER key, to add a check mark to it.
5. **Optional:** To receive an alarm when the radius has been crossed, turn on Waypoint Avoidance in the Navigation Alarms menu [Home > Alarms > Navigation > Waypoint Avoidance > On]

Display/Hide a Trolling Grid

The Trolling Grid applies a grid to the Chart View that can be used as a guide when trolling around a specific position. The trolling grid can be applied to any position on the chart.

1. Tap a position on the Chart View.

OR

Use the Joystick to move the cursor to a position on the Chart View.

2. Tap Chart in the status bar, or press the ENTER key.
3. Select Trolling Grid.
4. Use the menu options to set the grid size and rotation.

Display the Grid: Select Set Grid.

Remove the Grid: Select Remove Grid.

Delete a Waypoint in the Chart View

1. Tap the waypoint icon to select it. Tap the Waypoint Name.
2. **OR**
Use the Joystick to move the cursor to a waypoint icon. Press the ENTER key.
3. Select Delete.

ROUTES

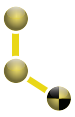

Routes link two or more points together to create a path for navigation. A route represents your intended navigation and shows the shortest path from each data point to the next. The distance between each route point is a **route leg**. You can save 50 routes to the control head.



Route Points are stored latitude/longitude positions that connect to form route navigation.



Route Start Point



Route End Point



WARNING! You should always be aware of your surroundings and watch for any potential obstacles.

Quick Route Navigation

A Quick Route allows you to connect route points and waypoints and start navigation immediately. A Quick Route can be started with the GO TO key or with the touch screen. Quick Routes can be saved or discarded. To create a saved route, see **Create a Saved Route** or **Manage your Navigation Data**.

Start Quick Route Navigation

Touch Screen

1. Tap Chart in the status bar.
2. Select Go To.
3. Select Quick Route.
4. Tap the chart in the positions where you want to mark a route point.
Undo Last Route Point: Tap the Back icon.
Cancel Route Creation: Tap the X icon.
5. To start navigation, tap the check icon in the status bar.

Keypad

1. Press the GO TO key.
2. Select Quick Route.
3. Use the Joystick to move the cursor to a position or waypoint. Press the Joystick to mark the first route point.
4. Repeat Step 3 to connect more than one route point.
Undo Last Route Point: Press the EXIT key once.
Cancel Route Creation: Press and hold the EXIT key.
5. To start navigation, press the ENTER key.

Marking Route Points with the Touch Screen

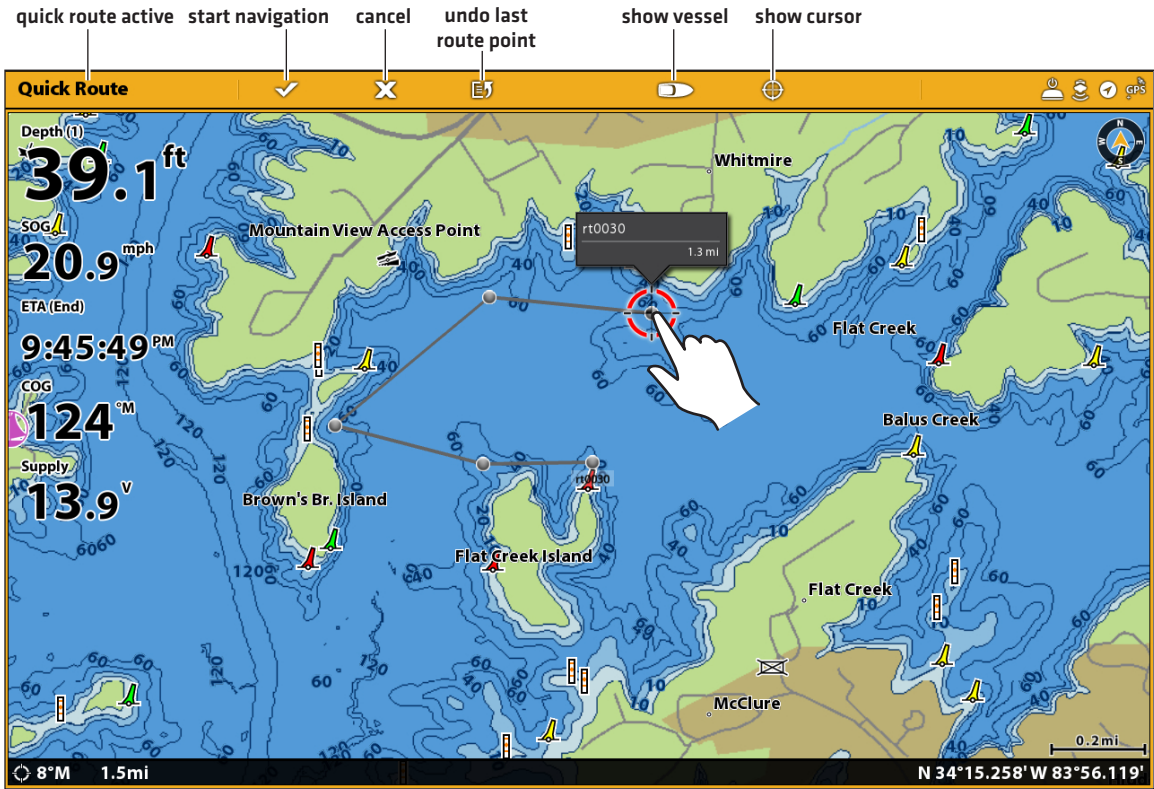

Tap to Mark
Route Points

Starting Quick Route Navigation with the Keypad

The screenshot shows a navigation interface with a top control bar and a main map area. The control bar includes buttons for 'quick route active', 'start navigation', 'cancel', 'undo last route point', 'show vessel', and 'show cursor'. The map area displays a route with several points and legs. Labels on the left side of the map include 'Depth (1) 39.1 ft', 'SOG 20.9 mph', 'ETA (End) 9:45:49 PM', 'COG 124°M', and 'Supply 13.9 V'. A red circle on the map is labeled 'cursor marking a route point'. Other map labels include 'Whitmire', 'Mountain View Access Point', 'Flat Creek', 'Balus Creek', 'Brown's Br. Island', 'Flat Creek Island', and 'McClure'. A scale bar at the bottom right indicates 0.2 mi. The bottom status bar shows '8°M 1.5mi' and coordinates 'N 34°15.258' W 83°56.119'.



Open Go To Menu

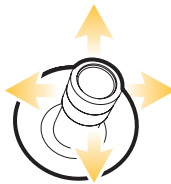

Move Cursor Position

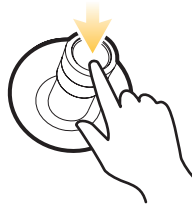

Mark Route Points



Start Navigation

Change Route Order During Navigation

1. During navigation, tap Chart in the status bar. Select Go To.

OR

Press the GO TO key.

2. Select one of the following menu options:

Restart Course: Resets navigation to start from the current vessel position to the next point in the route.

Next Point: Skips to the next point in the route.

Reverse Route: Reverses the currently navigated route. Navigation will start from the vessel position and continue in the opposite order.

Cancel Quick Route Navigation

1. During navigation, tap Chart in the status bar. Select Go To.

OR

Press the GO TO key.

2. Select Cancel Navigation.
3. Select Save Route or Discard Route.

Start Navigation to a Saved Waypoint or Route

Use the cursor to select a saved waypoint or route point on the Chart View, and you can start navigation to it. If you select a route point, you can also choose a navigation order for the selected route.

Start Navigation

Touch Screen

1. Tap a waypoint icon or route point.
2. Tap Chart in the status bar.
3. Select Go To.
4. Select Go To: Route or Go To: Point.

Cancel Navigation: Tap Chart in the status bar. Select Go To > Cancel Navigation.

Keypad

1. Use the Joystick to move the cursor to a waypoint or route point.
2. Press the GO TO key.
3. Select Go To: Route or Go To: Point.

Cancel Navigation: Press the GO TO key. Select Cancel Navigation.

Program a Position and Start Navigation

Use the instructions in this section to enter a latitude/longitude position and start navigation to it.

Start Navigation to a Latitude/Longitude Position

1. Tap Chart in the status bar. Select Go To.

OR

Press the GO TO key.

2. Select Lat/Long.
3. Use the on-screen keyboard to enter a position.
4. Select Go To.

Cancel Navigation: Press the GO TO key. Select Cancel Navigation.

Create a Saved Route

The instructions in this section allow you to create a route in the Chart View and save it for navigation later. The steps are similar to creating a Quick Route, but you will use the Mark menu to start.

Save Location: The route is saved to the Nav Data tool.

Navigation: To start navigation on the route, see *Start Navigation to a Saved Waypoint or Route*.

Overlay: To display saved routes on the Chart View, press the MENU key once.
Select Chart Options > Overlays > Nav Data > Routes [Saved].

Create a Saved Route

Touch Screen

1. Tap Chart in the status bar.
2. Select Mark.
3. Select Route.
4. Tap the screen in the positions where you want to mark a route point.

Undo Last Route Point: Tap the Back icon.

Cancel Route Creation: Tap the X icon.

5. To save the route, tap the check icon in the status bar.

Keypad

1. Press the MARK key.
2. Select Route.
3. Use the Joystick to move the cursor to a position or waypoint. Press the Joystick to mark the first route point.
4. Repeat Step 3 to connect more than one route point.

Undo Last Route Point: Press the EXIT key once.

Cancel Route Creation: Press and hold the EXIT key.

5. To save the route, press the ENTER key.

Creating a Saved Route with the Keypad

creating a saved route save route cancel undo last route point show vessel show cursor

Depth (1)
38.9 ft

Time
10:40 AM

SOG
3.8 mph

COG
110 °M

Supply
13.2 V

rt0024 3672.7 ft

Current Track

Big Creek

Gainey Ferry Islands

0.2 mi Swi

60°M 4855.6ft N 34°12.088' W 83°59.135'

cursor marking a route point

waypoint



Open Mark Menu

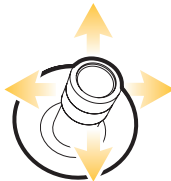

Move Cursor Position

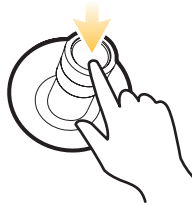

Mark Route Point



Save

Edit a Route in the Chart View

1. Tap the route to select it. Tap the Route Name.

OR

Use the Joystick to move the cursor to a route on the chart. Press the ENTER key.

2. Use the Route Info menu to edit the route name, color, and more [see *Manage your Navigation Data* for more information].

3. **Close:** Press the EXIT key.

Add or Delete Points in a Route

1. Tap the route to select it. Tap the Route Name.

OR

Use the Joystick to move the cursor to a route on the chart. Press the ENTER key.

2. Select Add Point, Extend Route, or Delete Point.

Delete a Route in the Chart View

1. Tap the route to select it. Tap the Route Name.

OR

Use the Joystick to move the cursor to a route on the chart. Press the ENTER key.

2. Select Delete Route.

Editing a Route on the Chart View

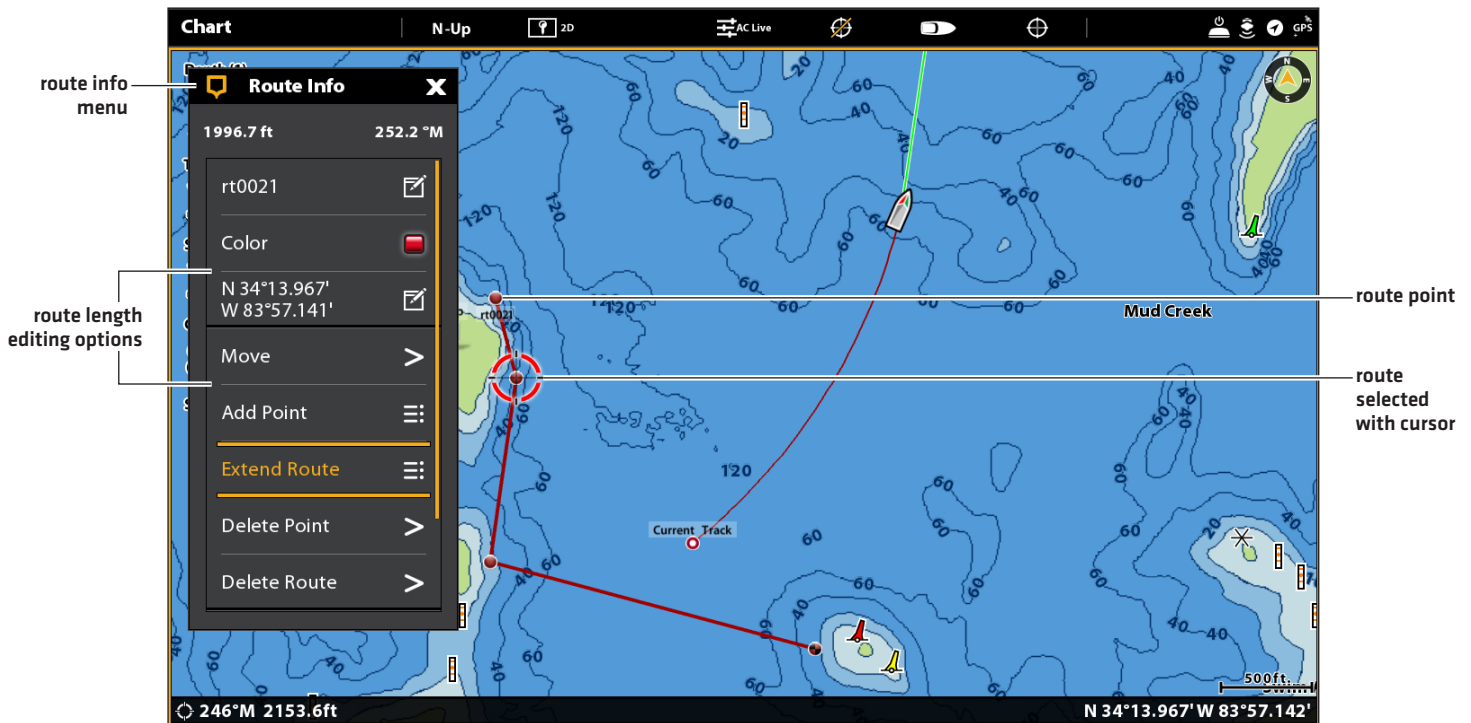

SEARCH

There are many ways to search the area for ports, services, tide stations, current stations, and other points of interest. You can also search the nearest waypoints, routes, and tracks. In many cases, you can also use the Go To menu to start navigation to your selection. The search options and the search area distance are determined by the selected map source.



NOTE: For more information about the ENTER key and the Info menu, see **Navigation Menu Overview**.

Search by Vessel Position

If Navionics is selected as the map source, you can run a search based on the vessel position.

1. Tap Chart in the status bar. Select Info.

OR

Press the ENTER key.

2. Select an item from the displayed list. Tap the item, or press the ENTER key, to see more information if it is available.
3. To start navigation to your selection, press the GO TO key.

Search by Cursor Position

If Navionics is selected as the map source, you can run a search based on the cursor position.

1. Press and hold a position on the Chart View.

OR

Use the Joystick to move the cursor to a position on the Chart View. Press the ENTER key.

2. Select Info.
3. Select an item from the displayed list. Tap the item, or press the ENTER key, to see more information if it is available.
4. To start navigation to your selection, press the GO TO key.

Search for a Lake

If Humminbird is selected as the map source, you can search for lakes in the area.

1. Tap Chart in the status bar. Select Info.

OR

Press the ENTER key.

2. **To search by area**, select Lake List.

To search by name, select Lake Name. Use the on-screen keyboard to enter a name.

3. Select an item from the displayed list. Tap the item, or press the ENTER key, to see more information if it is available.

Find the Nearest Navigation Data

Use the Find Nearest menu to search for the closest waypoints, routes, and tracks.

1. Tap Chart in the status bar. Select Info.

OR

Press the ENTER key.

2. Select Find Nearest.
3. Select Waypoints, Routes, or Tracks.
4. Select an item from the displayed list. Tap the item, or press the ENTER key, to see more information if it is available.
5. To start navigation to your selection, press the GO TO key.

TRACKS



A track is a collection of track points that contains the vessel's detailed position history at set intervals. The Current Track shows the position history since the control head was powered on. Record Track must be turned on to enable this feature [see **Record a Track**]. You can clear the Current Track or save it at any time. To change the track point interval, edit saved tracks, and create track settings, see **Manage your Navigation Data**. You can save 50 tracks (each with 20,000 track points) to the control head.



Start Point



End Point

Set up Tracks

Your control head is set to record tracks and display them on the view. Use the instructions in this section if you've changed the control head default settings.

Record a Track

When Record Track is turned on, the control head will save the current track. If Record Track is turned off, the track will not be recorded or saved.

1. Press the HOME key.
2. Select Nav Data tool.
3. Under Options, select Tracks.
4. Select Record Track. Tap the on/off button, or press the ENTER key, to turn it on.

Auto-Save

When Auto-Save is turned on, the control head will save the current track each time the control head is powered off, and a new track will be started when the control head is powered on again.

When Auto-Save is turned off, the current track will continue until you save it. See **Tracks: Save the Current Track**.

1. Press the HOME key.
2. Select Nav Data tool.
3. Under Options, select Tracks.
4. Select Auto Save. Tap the on/off button, or press the ENTER key, to turn it on.

Display Tracks on the Chart View

You can display saved tracks or active tracks on the Chart View.

1. With a Chart View displayed on-screen, tap Chart in the status bar.

OR

Press the MENU key once.

2. Select Chart Options.
3. Select Overlays > Nav Data.
4. Add a check mark to Tracks [Active] or Tracks [Saved] to make them visible on the Chart View.



NOTE: To set an individual track to visible or hidden, see **Manage your Navigation Data: Edit a Saved Track**.

Save the Current Track

Use the following instructions to save the current track and start a new track.

1. Tap a track start point or end point. Tap the Track Name.

OR

Use the Joystick to move the cursor to a track start point or end point. Press the ENTER key.

2. Select Save Track.



NOTE: You can also start a new track from the Nav Data tool. See **Manage your Navigation Data: Manage Tracks**.

Clear the Current Track

Use the following instructions to clear the current track and start a new track at the current vessel position.

1. Tap a track start point or end point. Tap the Track Name.

OR

Use the Joystick to move the cursor to a track start point or end point. Press the ENTER key.

2. Select Clear Track.

Chart View with a Track Displayed



Edit a Track in the Chart View

1. Tap a track start point or end point. Tap the Track Name.

OR

Use the Joystick to move the cursor to a track start point or end point. Press the ENTER key.

2. Edit the track name, style, color, and more from the Track Info menu.

3. **Close:** Press the EXIT key.



NOTE: To change the default appearance for new tracks, or to change the Track Point Interval, see **Manage your Navigation Data: Manage Tracks**.

Delete a Saved Track

When you delete a saved track, it is permanently deleted from the control head.

1. Tap a track start point or end point. Tap the Track Name.

OR

Use the Joystick to move the cursor to a track start point or end point. Press the ENTER key.

2. Select Delete Track.

MANAGE YOUR NAVIGATION DATA

Use the Nav Data tool to manage your saved waypoints, routes, tracks, and groups. You can edit your saved navigation data and start navigation from this tool.

Open the Nav Data Tool

1. Press the HOME key.
2. Select the Nav Data tool.

Sort Lists

1. Select a saved waypoint, route, or track.
2. Press the EXIT key to select the sort bar. Tap a column name, or move the Joystick and press it on a column name. The first tap/Joystick press will sort the column low to high or A to Z. The second tap/Joystick press will sort it high to low or Z to A.

Nav Data Tool

The screenshot displays the Nav Data Tool interface. On the left, a sidebar menu lists navigation data types: Lists, Waypoints (4), Routes (2), and Tracks (1). Below this is an 'Options' section for new navigation data, including Waypoints, Routes, Tracks, Groups, and a 'Delete All' button. The main area shows a table of waypoints with columns for Name, Group, Distance, and Date. The selected waypoint, wpt0004, is highlighted. Below the table, a detailed view of the selected waypoint is shown, including its position (N 34°11.783', W 84°3.580'), bearing (277.9 °M), depth (0.0 ft), cursor depth (0.0 ft), radius, temperature, altitude, and a map view. A 'Notes' field is also present.

| Name | Group | Distance | Date |
|---------|---------|----------|-----------------------|
| wpt0001 | My Data | 4582 ft | 10/30/2015 7:24:24 PM |
| wpt0002 | My Data | 4835 ft | 10/30/2015 7:26:02 PM |
| wpt0003 | My Data | 1.1 mi | 10/30/2015 7:26:48 PM |
| wpt0004 | My Data | 1.4 mi | 10/30/2015 7:27:00 PM |

Position: N 34°11.783' W 84°3.580'
Bearing: 277.9 °M
Depth: 0.0 ft
Cursor Depth: 0.0 ft
Radius: -
Temperature: -
Altitude: -
Notes:

Manage Waypoints

Edit a Waypoint

1. Under Lists, select Waypoints.
2. Press and hold a waypoint. Select Info.

OR

Use the Joystick to select a waypoint. Press the ENTER key.

3. Edit the waypoint using the options in the Waypoint Info menu. To see the complete list of options to edit the waypoint, select Full Info.

| Editing Options for Saved Waypoints or Default Settings | |
|---|--|
| Waypoint Name | Select the waypoint name and use the on-screen keyboard to change it. |
| Icon | Select an icon category [water, fishing, navigation, POI [point of interest], etc.] and select an icon to represent the selected waypoint on the Chart Views. |
| Color | Select a color to represent the waypoint on the Chart Views. |
| Depth Marker | If Depth Marker is turned on, the waypoint will be displayed as a depth marker on the Chart View. The depth is based on the depth at the vessel position. See Waypoints: Create a Depth Marker . If the waypoint was marked at the cursor position, the depth will not be saved. Select Edit Depth to enter a depth manually. |
| Position | Use the on-screen keyboard to edit the latitude/longitude position of the waypoint. |
| Radius | Turn on Radius and set the radius around the waypoint. The Radius is used for Waypoint Avoidance [see Navigation Alarms Overview]. |
| Avoidance | Add a check mark to the Avoidance box to display the Waypoint Avoidance Radius. |
| Visibility | To display the waypoint on the view, select On. To hide the waypoint on the view, select Off. You can also choose to display the icon or the icon and the waypoint name. |
| My Data [Group Name] | The menu name will vary with the default group name. Select the group name to change where the selected waypoint is saved. See Groups for more information. |
| Edit Depth | Use the on-screen keyboard to enter a depth for the waypoint if it was not marked at the vessel position. See Depth Marker for more information. |
| Edit Notes [select Full Info] | Use the on-screen keyboard to add notes about the waypoint. |

Change the Mark Mode for New Waypoints

When you mark a waypoint, the control head assigns an alphanumeric name that can be edited from the Nav Data tool. Use these instructions to change how the control head marks a waypoint, allowing you to mark and edit waypoints as you go, or mark waypoints and edit them with your favorite settings.

1. Under Options, select Waypoints.
2. Select Mark Mode.

| Mark Mode Options | |
|-----------------------------|---|
| Quick Mark | When you mark a waypoint, the waypoint name is alphanumeric and starts with wpt. The waypoint can be edited at a later time. You can also change the Quick Mark settings (icon, color, etc.) for new waypoints. See <i>Change Default Settings for New Waypoints</i> . |
| Mark + Edit | When you mark a waypoint, the Waypoint Info menu opens so you can edit the waypoint when you mark it. |
| Mark Favorites (Default) | When you mark a waypoint, the Favorites menu opens so you can assign a favorite icon and color to the waypoint on the go. To create favorite settings, see <i>Create Favorite Settings</i> . |

Change Quick Mark Settings for New Waypoints

If you've selected Quick Mark as the Mark Mode for waypoints, each time you mark a new waypoint, the control head will use the Quick Mark settings to save the waypoint. Also, see ***Waypoints: Quick Mark Waypoints (on the go)*** for more information.

1. Under Options, select Waypoints.
2. Select Quick Mark Settings. You can change the default settings for the icon, color, and more. See the table ***Editing Options for Favorite Waypoint Settings*** in this section for details.

Create Favorite Settings

If you've selected Mark Favorites as the Mark Mode for waypoints, use the instructions in this section to preset your favorite icon, color, depth marker, default group, and whether the waypoint is visible or hidden. When you mark a waypoint, you will be given the menu options from your favorite settings to edit the waypoint.

1. Under Options, select Waypoints.
2. Select Favorite Settings. Tap the item or use the Joystick to make your selections.

Selecting 5 Favorite Colors



| Editing Options for Favorite Waypoint Settings | |
|--|--|
| Icon | Select 5 icons to be your favorite icons. |
| Color | Select 5 colors to be your favorite colors. |
| Depth Marker | If Depth Marker is turned on, the waypoint will be displayed as a depth marker on the Chart View. The depth is based on the depth at the vessel position. See Waypoints: Create a Depth Marker . If the waypoint was marked at the cursor position, the depth will not be saved. Select Edit Depth to enter a depth manually. |
| Group | The menu name will vary with the default group name. Select the group name to change where the selected waypoint is saved. See Groups for more information. |
| Visibility | To display the waypoint on the Chart Views, select On. To hide the waypoint on the Chart Views, select Off. |

Delete a Waypoint

1. Under Lists, select Waypoints.
2. Tap a waypoint or use the Joystick to select it.
3. Press the ENTER key.
4. Select Full Info.
5. Select Delete.

Navigate to a Selected Waypoint

1. Under Lists, select Waypoints.
2. Tap a waypoint or use the Joystick to select it.
3. Press the GO TO key.
4. Press the ENTER key, or tap Go To on-screen.

Manage Routes

Edit a Route

1. Under Lists, select Routes.
2. Press and hold a route. Select Info.

OR

Use the Joystick to select a route. Press the ENTER key.

3. Edit the route using the options in the Route Info menu.

To see the complete list of options to edit the route, select Full Info.

| Editing Options for New Routes or a Saved Route | |
|---|--|
| Route Name | Select the route name and use the on-screen keyboard to change it. |
| Color | Select a color to represent the route on the Chart Views. |
| Visibility | To display the route on the view, select On. To hide the route on the view, select Off. |
| My Data [Group Name] | The menu name will vary with the default group name. Select the group name to change where the route is saved. See Groups for more information. |
| Edit Notes [select Full Info] | Use the on-screen keyboard to add notes about the route. |

Change Default Settings for New Routes

1. Under Options, select Routes.
2. Select Default Settings.

Selected Route with Route Points

The screenshot displays a navigation application interface. On the left is a 'Nav Data' sidebar with a 'Lists' section containing 'Waypoints 4', 'Routes 2', and 'Tracks 1'. The 'Routes' item is highlighted, with a label 'routes selected' pointing to it. The main 'Routes' panel shows a table with columns for Name, Group, Distance, and Date. Two routes are listed: 'rt0002' (1.9 mi, 10/30/2015 7:24:41 PM) and 'rt0001' (2.0 mi, 10/30/2015 7:11:28 PM). The 'rt0002' row is highlighted with a yellow bar, and a label 'selected route' points to it. Below the table, a detailed view for the selected route is shown, including position (N 34°11.673', W 84°3.389'), bearing (291.9 °M), route distance (3124 ft), and route points (5). A map shows the route points as red circles connected by a red line. A label 'selected route and preview window summary' points to this detailed view. A 'Notes' field is also present.

| Name | Group | Distance | Date |
|--------|---------|----------|-----------------------|
| rt0002 | My Data | 1.9 mi | 10/30/2015 7:24:41 PM |
| rt0001 | My Data | 2.0 mi | 10/30/2015 7:11:28 PM |

Position: N 34°11.673'
W 84°3.389'

Bearing: 291.9 °M

Route Distance: 3124 ft
Route Points: 5

Notes:

Delete a Route Point

Touch Screen

1. Under Lists, select Routes.
2. Tap a route to open it and display its route points.
3. Press and hold a route point.
4. Select Info.
5. Select Full Info.
6. Select Delete Point.

Keypad

1. Under Lists, select Routes.
2. Use the Joystick to select a route. Press the Joystick to open the route and display its route points.
3. Select a route point.
4. Press the ENTER key.
5. Select Full Info.
6. Select Delete Point.

Delete a Route

This menu option is not available while the selected route is being navigated.

1. Under Lists, select Routes.
2. Press and hold a route. Select Delete.

OR

Use the Joystick to select a route. Press the ENTER key.

3. Select Full Info.
4. Select Delete Route.

Navigate a Selected Route

1. Under Lists, select Routes.
2. Tap a route or use the Joystick to select it.
3. Press the GO TO key.
4. Press the ENTER key, or tap Go To on-screen.

Manage Tracks

Track Options for the Current Track

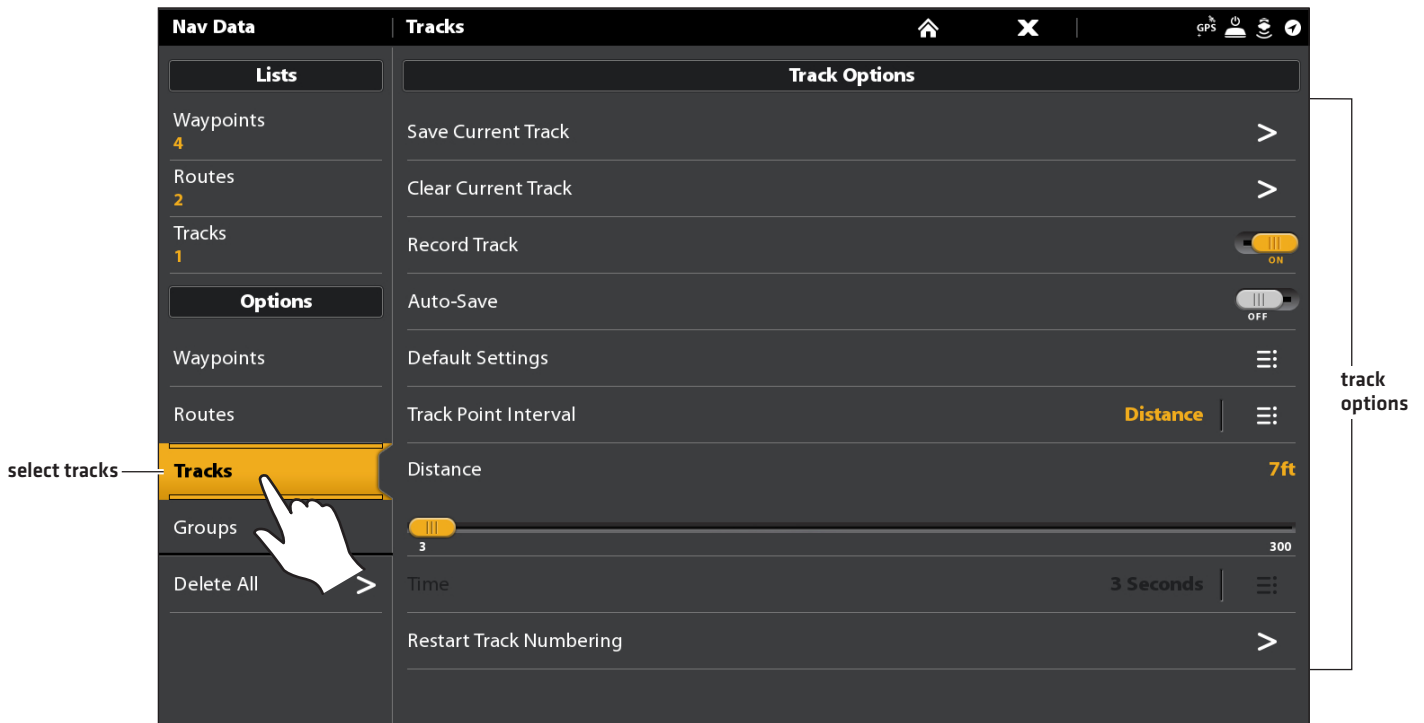

Start a New Track

The Record Track menu must be turned on to enable this feature.

1. Under Options, select Tracks.
2. Select New Track.

Record a Track

When Record Track is turned on, the control head will save the current track. If you power off the control head and then power on the control head at a different position, there might be gaps in the track.

If Record Track is turned off, the track will not be displayed on the Chart View, and the track will not be recorded or saved.

1. Under Options, select Tracks.
2. Select Record Track. Tap the on/off button, or press the ENTER key, to turn it on.

Auto-Save

When Auto-Save is turned on, the control head will save the current track each time the control head is powered off, and a new track will be started when the control head is powered on again.

When Auto-Save is turned off, the current track will continue until you save it [see **Tracks: Save the Current Track**].

1. Under Options, select Tracks.
2. Select Record Track. Tap the on/off button, or press the ENTER key, to turn it on. The control head will start recording the current track at the moment the menu is turned on.

Change Default Settings for New Tracks

1. Under Options, select Tracks.
2. Select Default Settings.

| Changing the Default Settings for New Tracks | |
|--|---|
| Style | Select a line style. |
| Color | Select a color. |
| Group | Select the group name to change where tracks will be saved. You can also open a new group from this menu. See Groups for more information. |

Change the Track Point Interval

1. Under Options, select Tracks.
2. Select Track Point Interval.
3. Select Distance or Time.
4. Select the Back icon on the status bar, or select the Tracks tab under Options to return to the Track Options menu.
5. If you selected Distance in step 3, adjust the Distance slider to adjust the distance between track points.

If you selected Time in step 3, select Time and open the menu. Select the amount of time between track points.

Edit a Saved Track

1. Under Lists, select Tracks.
2. Press and hold a track. Select Info.

OR

Use the Joystick to select a track. Press the ENTER key.

3. Edit the saved track using the options in the Track Info menu.
To see the complete list of options to edit the track, select Full Info.

| Editing Options for a Saved Track | |
|-----------------------------------|---|
| Track Name | Select the track name and use the on-screen keyboard to change it. |
| Style | Select a line style. |
| Color | Select a color. |
| Visibility | To display the track on the Chart Views, select On. To hide the track on the Chart Views, select Off. |
| My Data [Group Name] | The menu name will vary with the default group name. Select the group name to change where the selected track is saved. See Groups for more information. |
| Edit Notes [select Full Info] | Use the on-screen keyboard to add notes about the selected track. |

Delete a Track

1. Under Lists, select Tracks.
2. Press and hold a track. Select Delete.

OR

1. Use the Joystick to select a track. Press the ENTER key.
2. Select Full Info.
3. Select Delete Track.

Manage Groups

Use Groups to organize your navigation data (waypoints, routes, and tracks) in one set. Some anglers prefer to group their navigation data by trip, fish-type, body of water, or time of day. APEX/SOLIX can hold up to 50 groups.

Default Group: Your navigation data is saved to My Data, the default group for your control head. You can create new groups and save new navigation data to them. You can also move saved navigation data to a different group.

Create a New Group

1. Under Options, select Groups.
2. Select New Group.
3. Use the on-screen keyboard to name the new group.
4. Select Save.

Set the Default Group

Your navigation data is saved to My Data as the default group. The instructions in this section allow you to save your new navigation data to a different group, so as a waypoint, route, or track is saved, it will be saved to the group you've set up. You can assign waypoints, routes, and tracks to different groups, or you can assign them to the same group.

1. Under Options, select Waypoints, Routes, or Tracks.
2. Select Default Settings.
3. Select Group.
4. Select a group from the list.
To create a new group, Select New Group.
5. Repeat these instructions for each type of navigation data.

Move Navigation Data to a Group

1. Under Lists, select Waypoints, Routes, or Tracks.
2. Tap a saved item or use the Joystick to select it.
3. Press the ENTER key.
4. Select My Data [or the current group name].
5. Select a group from the list.
To create a new group, select New Group.

Delete All Navigation Data

The Delete All menu allows you to select a navigation data category and delete all items in that category. For example, if you select Delete All > Waypoints, all saved waypoints will be deleted.

To delete individual waypoints, or other individual navigation items, see the previous sections of *Manage your Navigation Data*.



WARNING! Use this menu with caution!

1. Under Options, select Delete All.
2. Select a category. **Follow the on-screen prompts to confirm the deletion.**

Import/Export Navigation Data

APEX and SOLIX allow you to export your waypoints, routes, and tracks, so you can view the data on your personal computer. You can also import your navigation data.



WARNING! Humminbird is not responsible for the loss of data files (waypoints, routes, tracks, groups, snapshots, recordings, etc.) that may occur due to direct or indirect damage to the unit's hardware or software. It is important to back up your control head's data files periodically. See our Web site at humminbird.com for details.

Import Navigation Data

Requirements: Humminbird navigation data saved as a GPX file.

1. Install the SD card (with navigation data) into the front control head port.
2. Press the HOME key.
3. Select the Files tool.
4. Under Import, select Nav Data.
5. Select a .GPX file. The navigation data will be imported to the control head.

Export Navigation Data

1. Install a formatted SD card into the front control head port.
2. Press the HOME key.
3. Select the Files tool.
4. Under Export, select Nav Data.
5. **Select a Save Location:** Select the port where the SD card is installed.

All saved navigation data will be exported to the selected location.

AUTOCHART LIVE OVERVIEW

AutoChart Live uses data from an installed GPS receiver and 2D transducer (down beam, digital CHIRP or single-frequency DualBeam PLUS or DualSpectrum) to create detailed depth maps of your favorite waters.

Map Source: Humminbird CoastMaster, Humminbird LakeMaster or Navionics

Storage: AutoChart Live **saves** 8 hours of mapping data on your control head. After 8 hours of data has been collected, you can erase the data and continue mapping, or you can purchase a ZeroLine Map Card for unlimited mapping.

ZeroLine Map Card: To purchase a ZeroLine Map Card and download the accessory guide, visit our Web site at humminbird.com.

More Information: Visit our Web site for informational videos.

PLAN YOUR MAP

Before getting started, consider the areas where you want to create a map. Review the following tips to help you plan your map:

General Tips

- Start with your favorite fishing hot spots. It is not recommended to record survey data of an entire lake, as it will require a lot of time to map and might include areas you don't want.
- Take a different route to and from each fishing spot every trip. You may discover new and interesting areas to map.
- Start a new track or recording when you start for the day. Record new data every trip to create new maps or improve existing maps.
- Navigate the boat at a consistent speed when recording data.
- See the illustration below for instruction on how to navigate your boat while recording survey data.

Mapping a Specific Area or Object in Detail

- Navigate the boat across the area rather than alongside.
- Turn the boat where the area and/or object is out of range of the transducer beam[s].
- Try to reduce the measurement time, so as to reduce the error due to possible GPS variations.

Mapping an Entire Lake

- Follow a plan.
- Follow the maximum gradient of the sea floor (up or down).
- Keep a steady speed. Trolling speeds to low speeds are recommended.
- Turn the boat where the bottom is flat if possible.

Navigating the Boat to Record Survey Data

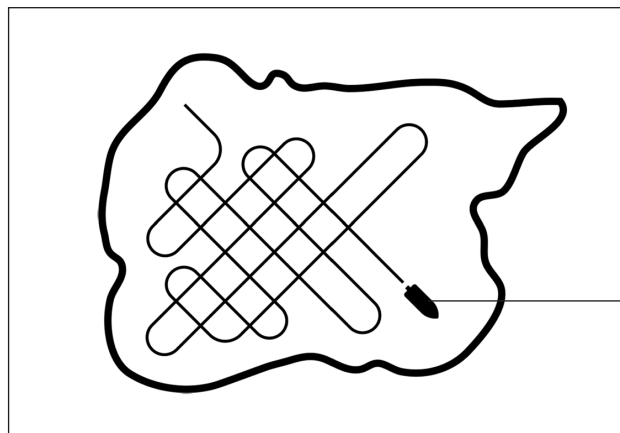

Navigate your boat in a zig-zag pattern, first in one direction and then in the other.

1. PREPARE THE CONTROL HEAD FOR MAPPING

When you start your mapping for the day, it is important to note if the water level is higher or lower than usual. It is also important to use your 2D transducer beams exclusively.

1 | Set the Map Source

AutoChart LIVE can be used when Humminbird CoastMaster, Humminbird LakeMaster or Navionics is set as the map source. When you install a map card, the map source is changed automatically to match the SD card map source. If your control head has two cards installed, you can choose which map source you want to use. You can also change the map source using the Settings tool.

1. Press the HOME key.
2. Select Settings.
3. Select Chart.
4. Select Humminbird or Navionics.

2 | Confirm the 2D Transducer and Turn off Additional Transducers

To record your custom map, you must have a reliable and accurate digital depth from a pinging 2D transducer. You can use your Humminbird CHIRP transducer with 2D (down beam) capabilities, DualBeam PLUS transducer (83/200 kHz or 50/200 kHz), or the Side Imaging transducer with 2D (down beam) capabilities.

When you are recording your map, you should have only one 2D transducer pinging on your boat. If you have other 2D transducers pinging on remote control heads, you should turn them off. Down Imaging and Side Imaging beams can operate at the same time. You do not need to turn them off.

1. Press the HOME key.
2. Select Settings.
3. Select CHIRP Sonar.
4. Select Sonar Source.
5. Select the 2D Sonar tab.
6. Confirm that 2D Pinging is turned on. Tap the **2D Pinging** on/off button, or press the ENTER key, to turn it **on**.

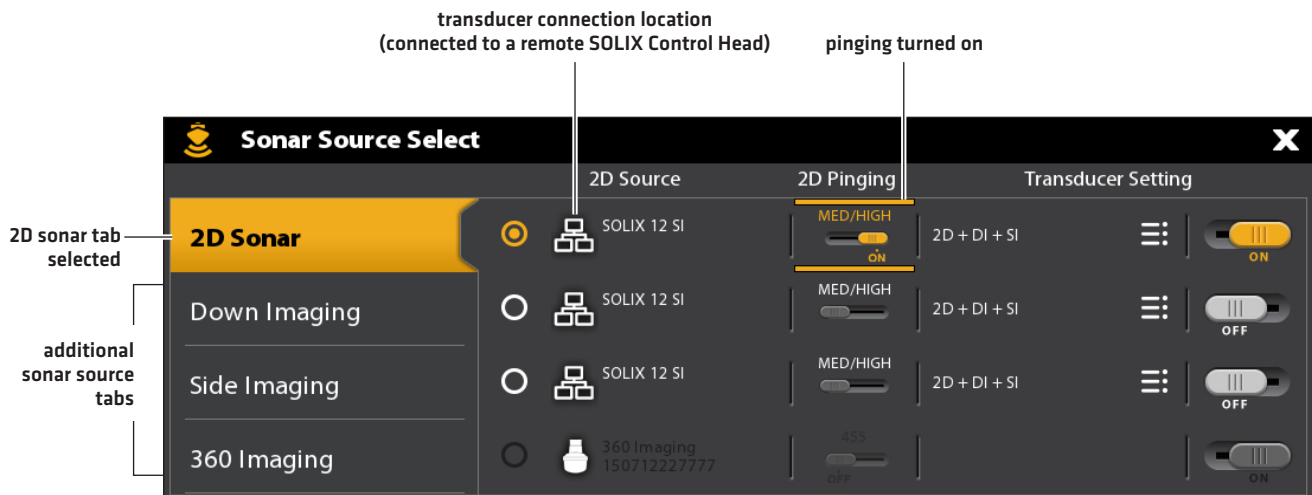

NOTE: For more information about the Sonar Source Select dialog box, see **Set up your Humminbird Network: Select Sonar Sources**.

7. Press and hold the EXIT key to close the menu system.

- If there are additional control heads on your boat with a 2D transducer, confirm that they are not pinging while you are mapping. There should be only one 2D transducer pinging on your boat during the recording process.

3 | Confirm Digital Depth and GPS Fix

- Press the HOME key.
- Select a Chart View from the Views tool or the Favorites bar.
- Confirm Digital Depth:** Confirm the depth digital readout is displayed.
It may take a moment for depth to be displayed.
- Confirm GPS Fix:** Review the status bar and confirm the GPS icon is white. Confirm the speed digital readout is displayed. See *Getting Started: Check Sensor Reception and Connections* for more information.

digital depth missing

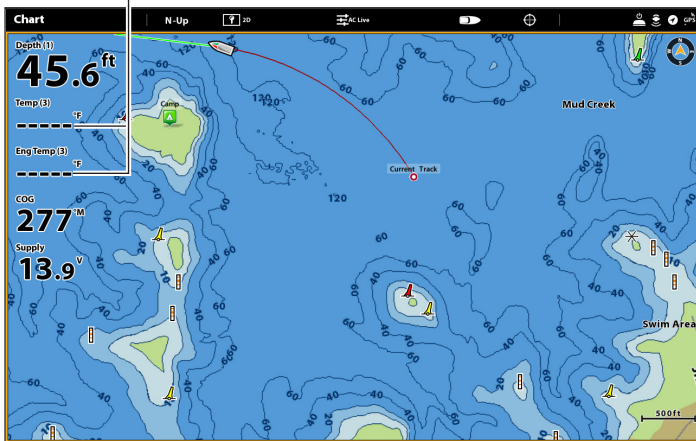

digital depth detected speed

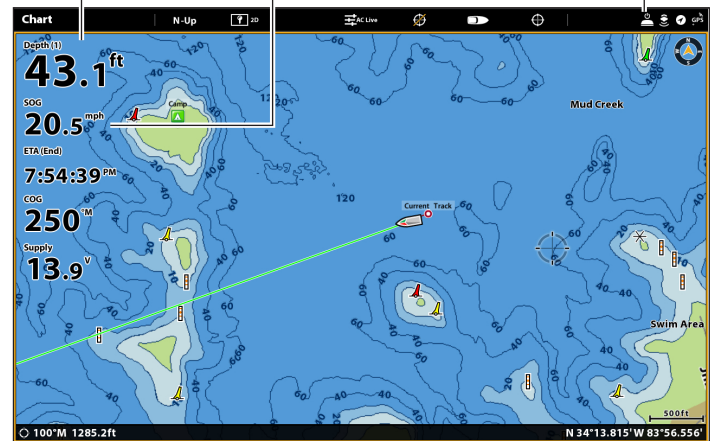

4 | Adjust the Water Level Offset

When you start your mapping for the day, it is important to note if the water level is higher or lower than usual. For example, if you know the lake is down 3 feet, set the Water Level Offset to -3.

- With a Chart View displayed on-screen, tap Chart in the status bar, or press the MENU key once.
- Select Water Level Offset.
Tap the on/off button, or press the ENTER key, to turn it on.
- Press and hold the slider, or press and hold the ENTER key, to adjust the setting.

If the water level is higher than normal, set a positive amount.

If the water level is lower than normal, set a negative amount.

If the water level has not changed [normal], turn off Water Level Offset.

5 | Display the Current Track (optional)

It is helpful to display the current track so you can see where the boat has already traveled while you're recording the map.

1. With a Chart View displayed on-screen, tap Chart in the status bar, or press the MENU key once.
2. Select Chart Options.
3. Select Overlays > Nav Data.
4. Tap the Nav Data on/off button, or press the ENTER key, to turn it on.
5. Add a check mark to Tracks [Active].
6. Press and hold the EXIT key until the menu system is closed.

To change the track color, see **Manage your Navigation Data: Manage Tracks**.

6 | Start a Sonar Recording for AutoChart PC (optional)

If you are planning to use AutoChart PC, start a sonar recording before you start recording your custom map. Sonar Recording can be started from the Recordings tool or from the X-Press Menu in a Sonar View. The instructions for the Recordings tool are shown here.

1. Press the HOME key.
2. Select the Recordings tool.
3. Select Record Sonar.
4. Select Recording Sources. Tap 2D Sonar, or press the ENTER key, to add a check mark to the box.
5. Press the EXIT key.
6. Select Start Recording.



NOTE: For more information, see **Sonar Recording**. Also, visit our Web site at **humminbird.com** to purchase AutoChart PC and download the manual.

2. RECORD YOUR CUSTOM MAP

While recording your custom map, Chart View will display the depth contour data in real time. Bottom hardness and vegetation will be recording at the same time, however, the data is not displayed in real time on the Chart View.

1. **Preparation:** Before you start mapping for the day, confirm that the control head is set up as shown in the section *Prepare the Control Head for Mapping*.
2. With a Chart View displayed on-screen, tap Chart in the status bar, or press the MENU key once.
3. Select AutoChart LIVE.
4. Select Record.
5. Tap the on/off button, or press the ENTER key, to turn it on.

Display: Select AutoChart LIVE. Tap the check box, or press the ENTER key, to add a check mark to it.

Zoom In: Press the + ZOOM key to see the depth data on the Chart View.

Navigate your boat in a zig-zag pattern, first in one direction and then in the other. Maintain a consistent low speed to trolling speed while you map. See *Plan your Map* for details.

Starting an AutoChart LIVE Recording

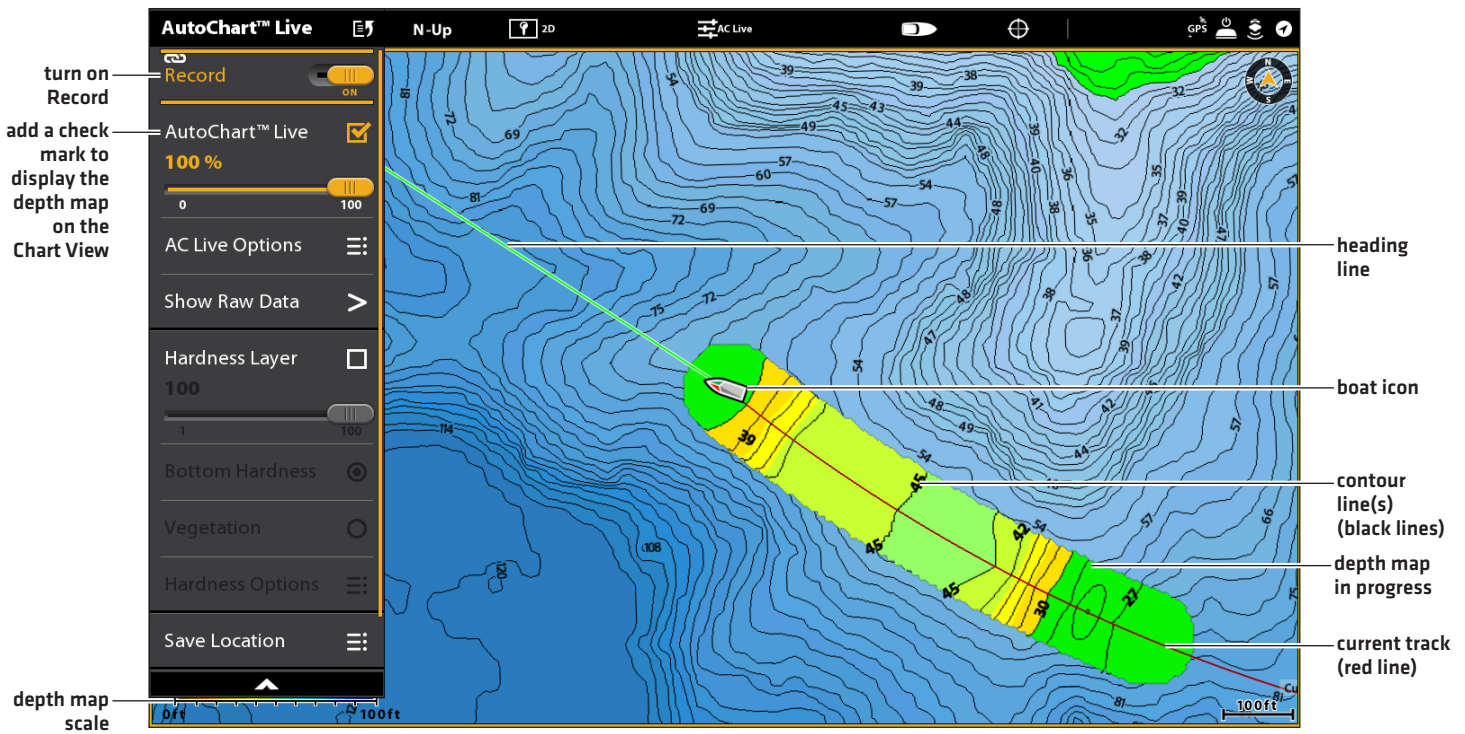

Collecting Data for your AutoChart LIVE Map

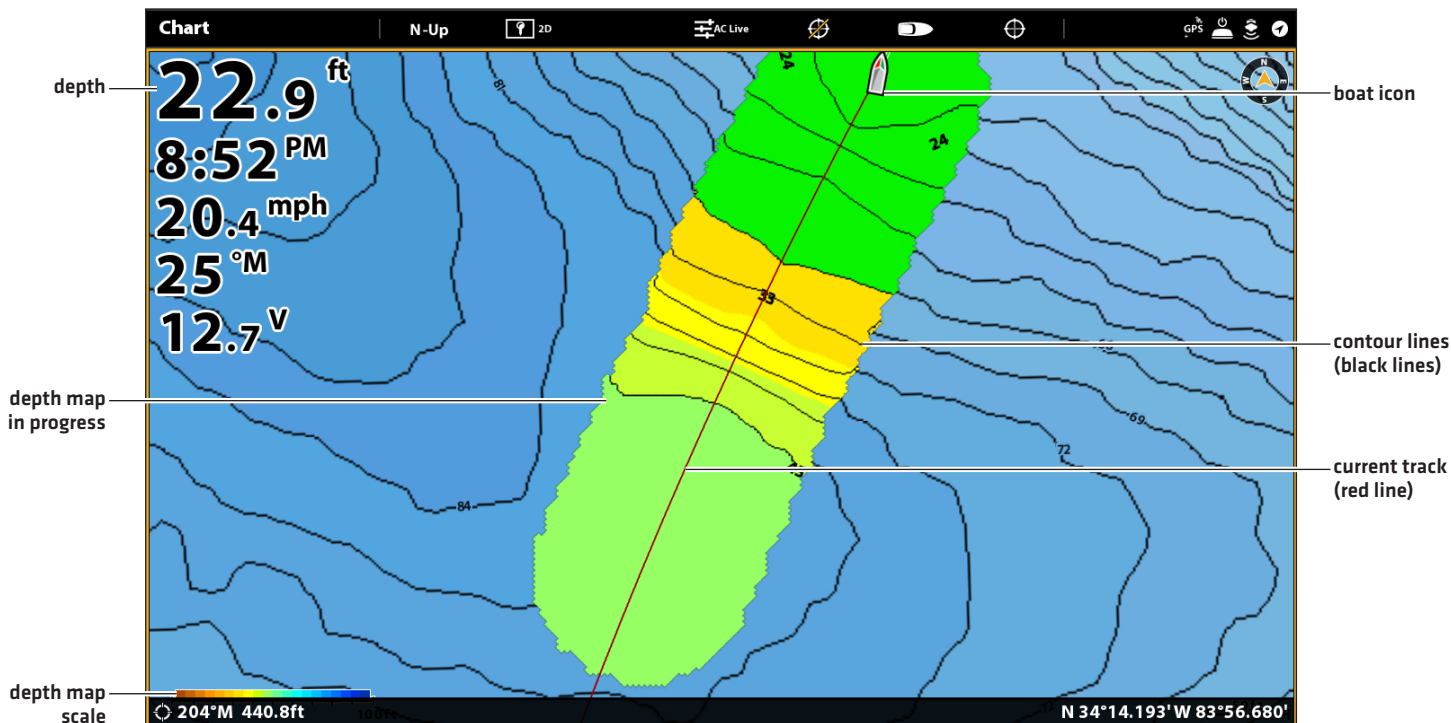

3. STOP RECORDING

Use the instructions in this section to stop recording. Your map is automatically saved to the control head [internal] or to the ZeroLine Map Card if it is installed.

1. With a Chart View displayed on-screen, tap Chart in the status bar, or press the MENU key once.
2. Select AutoChart LIVE.
3. Select Record. Tap the on/off button, or press the ENTER key, to turn it off.

If you do not have a Zero Line Map Card installed, and the control head storage [8 hours] is reached, the control head will provide a dialog box to Confirm or Clear Data. To save your map and turn off recording, select Confirm. To erase your map and start over, select Clear Data.

CORRECT DATA

If you see an irregularity in the data [such as lost depth], it can be corrected. Recording must be turned off while you correct the data.

1. With a Chart View displayed on-screen, tap Chart in the status bar, or press the MENU key once.
2. Select AutoChart LIVE.
3. **Turn Off Recording:** Select Record. Tap the on/off button, or press the ENTER key, to turn it off.
4. Select Show Raw Data.
5. Press the +ZOOM key to see individual data points.
6. Tap the data point, or use the Joystick to select the data point.
7. From the AutoChart LIVE menu, select Delete Data.

Optional: Record the area again. See *Record your Custom Map*.

Selecting a Data Point

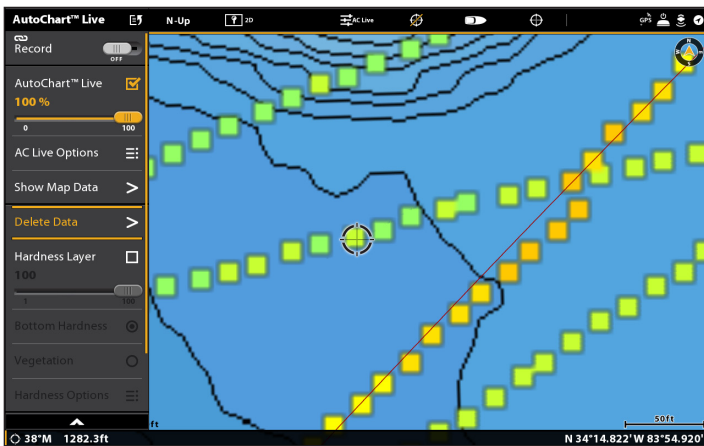

The Data Point is Removed

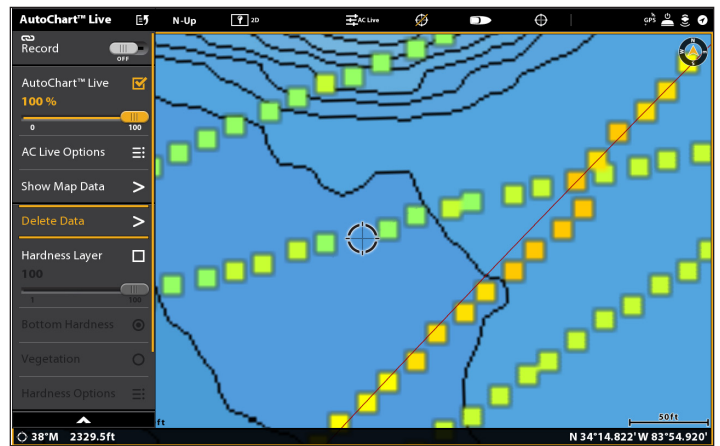

DISPLAY THE AUTOCHART LIVE MAP

You can make changes to the AutoChart Live map during recording or after you've saved your map. You can also view bottom hardness or vegetation data, and you can customize how the data is displayed.

Display/Hide your Custom Map

The custom map can be displayed or hidden while you are recording or after the map is saved. You can also adjust the transparency.

Display the Map

1. With a Chart View displayed on-screen, tap Chart in the status bar, or press the MENU key once.
2. Select AutoChart LIVE.
3. Select AutoChart LIVE. Tap the check box, or press the ENTER key, to add a check mark to it.

Adjust the Transparency

1. Press and hold the AutoChart LIVE slider, or turn the Rotary dial, to adjust the transparency.

Adjusting the Overlay Transparency

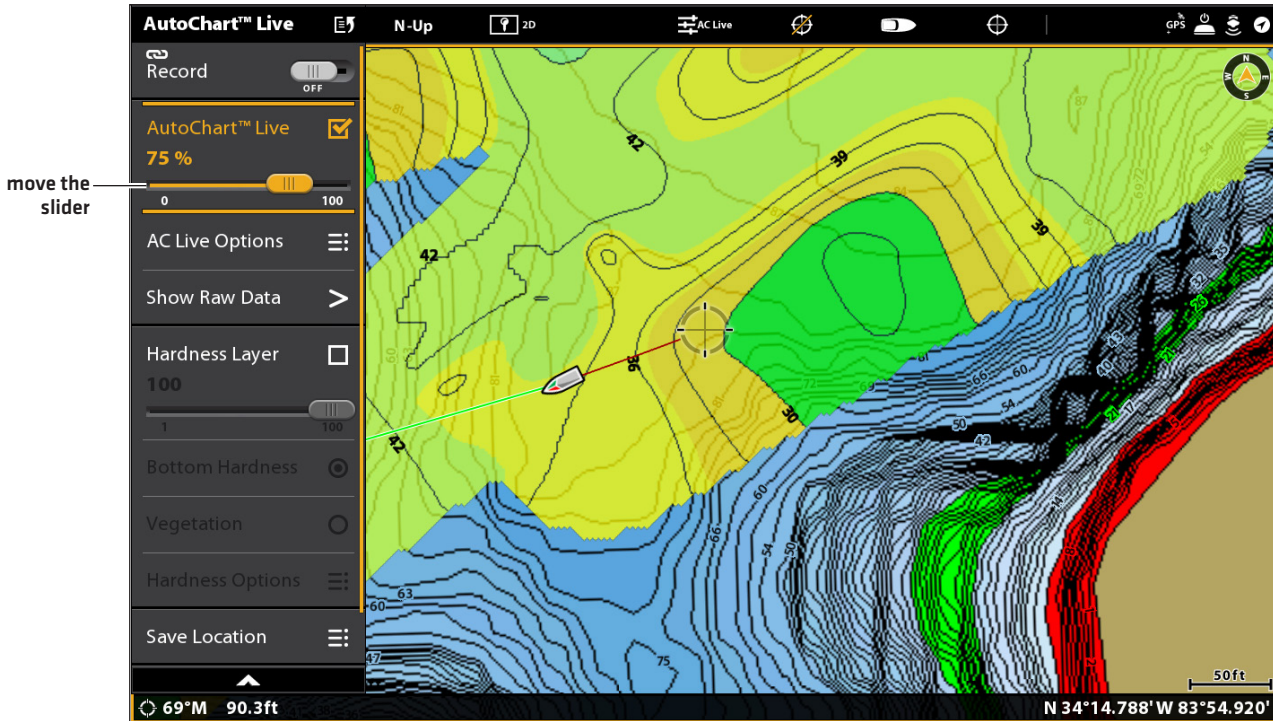

Hide the Map

1. With a Chart View displayed on-screen, tap Chart in the status bar, or press the MENU key once.
2. Select AutoChart LIVE.
3. Select AutoChart LIVE. Tap the check box, or press the ENTER key, to remove the check mark.

Display the AC Live Color Bar

The AC Live Color bar allows you to display the palette icon for AutoChart Live or Bottom Type. You can use this icon to see the selected palette and, from left to right, the AutoChart Live depth range [low to high], Bottom Hardness range [soft to hard], or Vegetation range [soft to hard].

Show/Hide the AC Live Color Bar

1. With a Chart View displayed on-screen, tap Chart in the status bar, or press the MENU key once.
2. Select Chart Options.
3. Select Overlays > AC Live Color Bar.
4. Select Color Bar. Tap, or press the ENTER key, to turn it on.
5. Select a display bar.

Display AutoChart Live and Bottom Layer in Chart/Chart Combo View

You can also use the Chart/Chart Combo View to display AutoChart Live and Bottom Layer data at the same time. Use the X-Press Menu to make adjustments to each pane.

Display AutoChart Live and Bottom Layer Data in the Chart/Chart Combo View

1. Press the HOME key.
2. Open the Views tool.
3. Select a Chart/Chart Combo View.
4. With the Chart/Chart Combo View displayed on-screen, select a pane.
5. Tap Chart in the status bar, or press the MENU key once.
6. Select AutoChart Live.
7. Select Vegetation Layer or Hardness Layer. Tap the check box, or press the ENTER key, to add a check mark to it.
8. **Adjust the Transparency:** Press and hold the slider, or turn the Rotary dial, to adjust the transparency.
9. **Close:** Press the EXIT key until the menu is closed.
10. **Repeat:** Repeat steps 4 through 6.
11. Select AutoChart Live. Tap the check box, or press the ENTER key, to add a check mark to it.
12. **Adjust the Transparency:** Press and hold the slider, or turn the Rotary dial, to adjust the transparency.

Displaying AutoChart Live and Bottom Layer in Chart/Chart Combo View

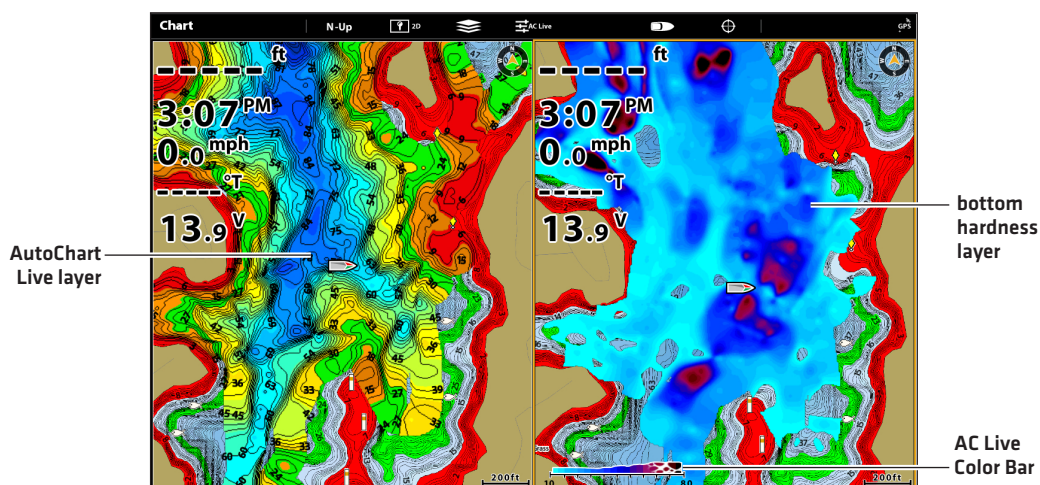

ADJUST THE MAP DISPLAY SETTINGS

Use the AutoChart Live Options menu to adjust the depth range, contour interval, and map position. You can also change the color palette and shading.

Some of the menu options in this section may be displayed in other parts of the menu system so that you can access them quickly. No matter where you make the change, the control head will update the setting across the system.

Open the AutoChart Live Options Menu

You will use the AutoChart Live Options menu for all display settings.

1. With a Chart View displayed on-screen, tap Chart in the status bar, or press the MENU key once.
2. Select AutoChart LIVE.
3. Select AC Live Options.

Adjust the Depth Range

You can adjust the range of data shown on the chart by changing the minimum range and maximum range on the display. The range you select affects how the depth colors are displayed. For best results, set a narrow depth range threshold. For example, set the Min Range to 10 and the Max Range to 30. For related color or shading options, see *Add Settings with Chart Options*.

1. From the AC Live Options menu, select Min Range.
2. Press and hold the slider, or press and hold the ENTER key, to adjust the setting.
3. Select Max Range.
4. Press and hold the slider, or press and hold the ENTER key, to adjust the setting.

Adjusting the Display Depth Range

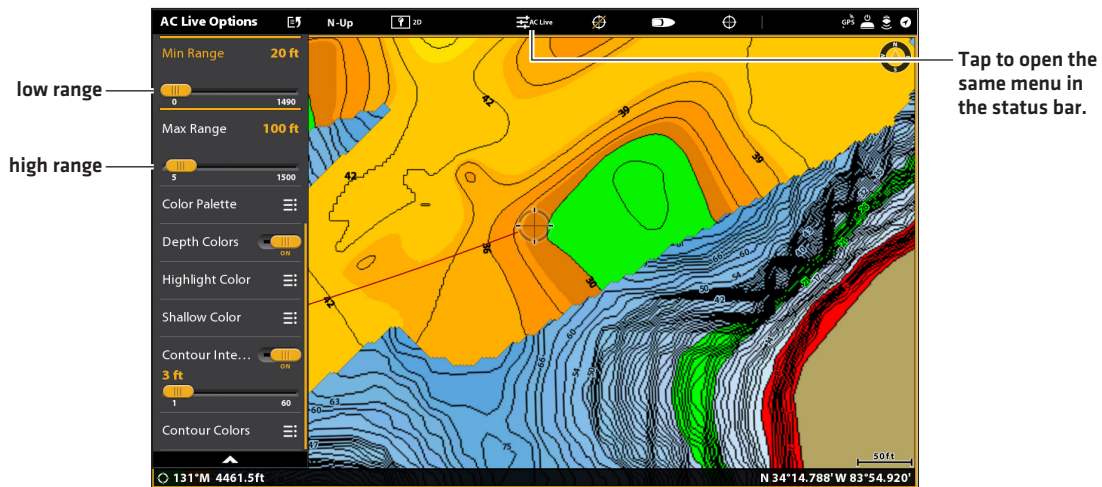

QUICK TIP! You can also select this menu on the status bar. See the illustration above.

Change the Display Colors

Use the following instructions to change the color palette used to display the AutoChart Live map.

Changing the AutoChart Live Color Palette

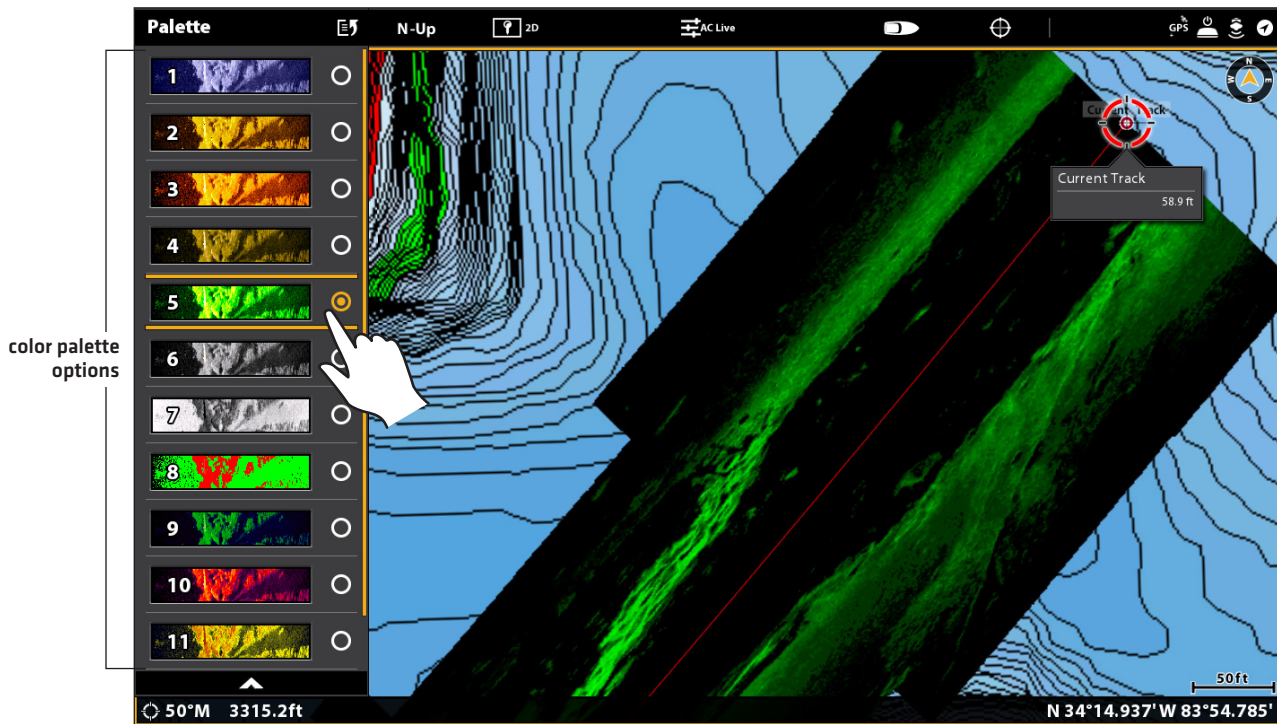

Change the Color Palette

The Color Palette menu changes the colors used to display the AutoChart Live map. The color range is shown in the AC Live Color bar and is affected by the Min Range and Max Range settings. See [Adjust the Depth Range](#) for more information.

1. From the AutoChart Live Options menu, select Color Palette.
2. Select a palette.

Show/Hide Depth Colors

Use the following instructions to show or hide the depth colors. If you hide the depth colors, the contours will be shown on the display.

1. From the AutoChart Live Options menu, select Depth Colors.
2. Tap the on/off button, or press the ENTER key, to turn it On [visible] or Off [hidden].

Change the Highlight Color

If you've set the Depth Highlight and Depth Highlight Range in the Humminbird Settings menu [Chart X-Press Menu > Humminbird Settings], and it is not easy to see with the AutoChart Live color palette you've selected, you can change the Highlight Color. See [Customize the Chart View](#) for more information.

1. From the AutoChart Live Options menu, select Highlight Color.
2. Select a color.

Change the Shallow Color

If you've set the Shallow Water Highlight in the Humminbird Settings menu [Chart X-Press Menu > Humminbird Settings], and it is not easy to see with the AutoChart Live color palette you've selected, you can change the Shallow Color. See **Customize the Chart View** for more information.

1. From the AutoChart Live Options menu, select Shallow Color.
2. Select a color.

Display or Adjust the Contour Interval

You can display or hide the contour lines on the map, and you can adjust the slider to set the distance between each contour line. Contour Interval is also affected by the Water Level Offset setting.

Display the Contour Lines and Adjust the Contour Interval

1. From the AutoChart Live Options menu, select Contour Interval.
2. Tap the on/off button, or press the ENTER key, to turn it on.
3. Press and hold the slider, or press and hold the ENTER key, to adjust the setting.

Change the Contour Lines Color

1. From the AutoChart Live Options menu, select Contour Colors.
2. Select a color.

Adjusting the Contour Interval

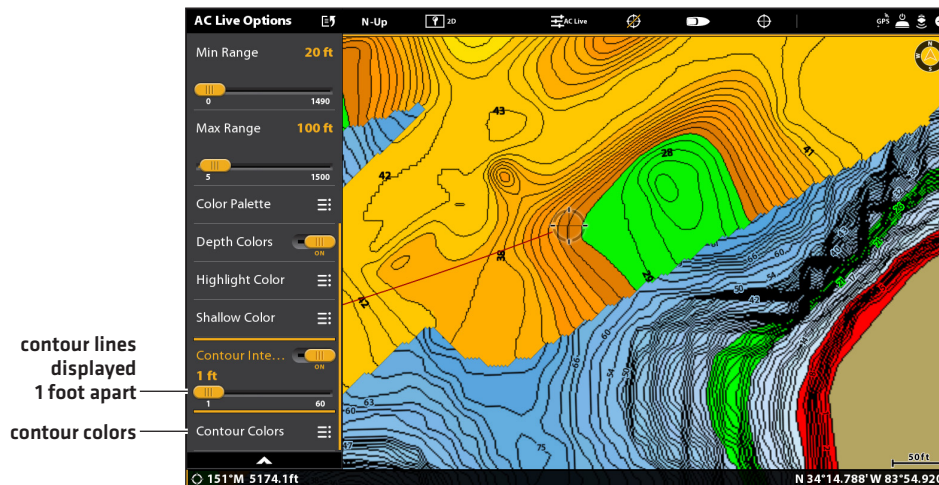

Display Raw or Map Data

Select Show Map Data to display contour lines and depth data. Select Show Raw Data to display individual data points.

1. From the AutoChart Live menu, select Show Raw Data or Show Map Data.
2. Press the ENTER key.

Change the Water Level Offset

When you start your mapping for the day, it is important to note if the water level is higher or lower than usual. See *Prepare the Control Head for Mapping* for more information.

1. From the AutoChart Live Options menu, select Water Level Offset.
2. Tap the on/off button, or press the ENTER key, to turn it on.
3. Press and hold the slider, or press and hold the ENTER key, to adjust the setting.

If the water level is higher than normal, set a positive amount.

If the water level is lower than normal, set a negative amount.

If the water level has not changed [normal], turn off Water Level Offset.

Add Humminbird Chart Settings

If Humminbird is set as the map source, you can add Depth Colors, Shallow Water, etc. to your AutoChart LIVE map. See *Customize the Chart View: Adjust the Depth Range and Colors* for more information.

Adding Shallow Water Settings to the Map (Map Source: Humminbird)

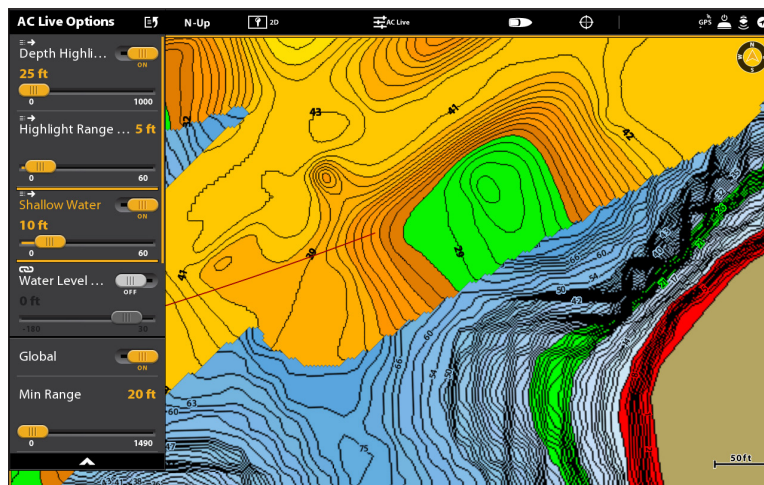

Add Navionics Settings with Chart Options

If Navionics is set as the map source, you can display Contours and Shading on your AutoChart LIVE map. See *Customize the Chart View: Select Map Data* for more information.

CUSTOMIZE THE BOTTOM HARDNESS DISPLAY SETTINGS

The bottom layer is displayed on top of the AutoChart Live map and can be displayed as bottom hardness or vegetation. Bottom Hardness shows strong sonar returns resulting from compacted sediment, rocks, fallen trees, etc.

Show/Hide Bottom Hardness

The bottom layer is displayed on top of the AutoChart Live map, and you can adjust the transparency to see different layers on the view. Both bottom hardness and bottom vegetation cannot be displayed at the same time in Chart View.

Show Bottom Hardness

1. From the AutoChart Live menu, select Hardness Layer or Vegetation Layer. Tap, or press the ENTER key, to add a check mark to the box.
2. Select Bottom Hardness.
3. **Adjust the Transparency:** Press and hold the slider, or press and hold the ENTER key, to adjust the setting.

Displaying the Bottom Hardness Layer (Map Source: Humminbird)

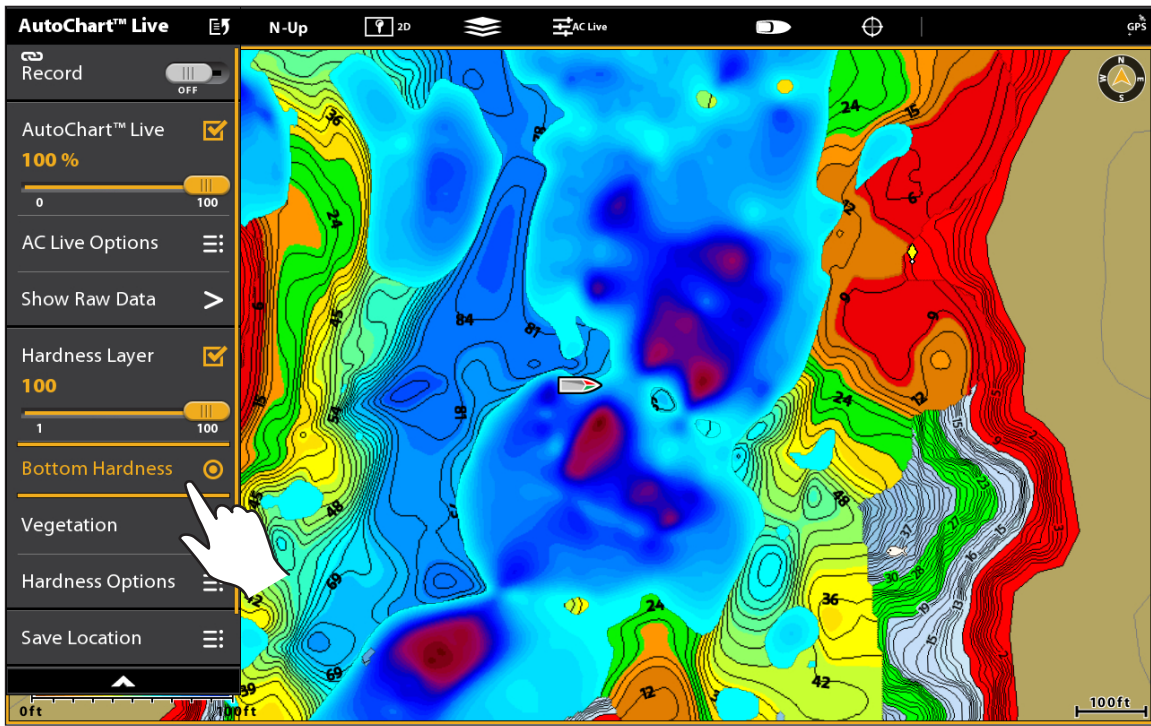

Hide Bottom Hardness

1. From the AutoChart Live menu, select Hardness Layer. Tap, or press the ENTER key, to remove the check mark from the box.

Adjust the Gain Offset

Use Gain Offset to tune the bottom hardness display. For example, if you're fishing a lake where most of the lake has a hard bottom, reduce the gain so only the hardest bottom is displayed.

1. From the AutoChart Live menu, select Hardness Options.
2. Select Gain Offset.
3. Press and hold the slider, or press and hold the ENTER key, to adjust the setting.

Adjust the Hardness Range

You can adjust the range of bottom hardness shown on the chart by changing the minimum range and maximum range on the display. The range you select affects how the bottom hardness colors are displayed. The range is displayed in the AC Live Color Bar with Bottom Hardness selected.

1. From the AutoChart Live menu, select Hardness Options.
2. Select Min Hardness. Press and hold the slider, or press and hold the ENTER key, to adjust the setting.
3. Select Max Hardness. Press and hold the slider, or press and hold the ENTER key, to adjust the setting.

Adjusting the Bottom Hardness Range (Map Source: Humminbird)

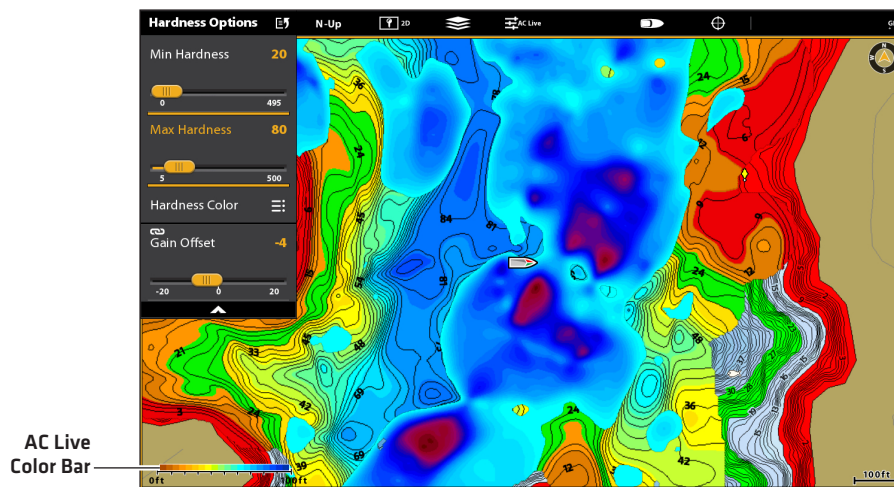

NOTE: Use the AC Live Color Bar icon see the selected palette and, from left to right, the AutoChart Live depth range [low to high], Bottom Hardness range [soft to hard], or Vegetation range [soft to hard].

Change the Bottom Hardness Colors

Use the following instructions to change the color palette used to display Bottom Hardness.

Change the Hardness Colors

The Hardness Color menu changes the colors used to display bottom hardness on the view. The color range is shown in the AC Live Color bar and is affected by the Min Hardness and Max Hardness settings. See **Adjust the Hardness Range** for more information.

1. From the AutoChart Live menu, select Hardness Options.
2. Select Hardness Color.
3. Select a palette.

**Changing the Bottom Hardness Colors
(Map Source: Humminbird)**

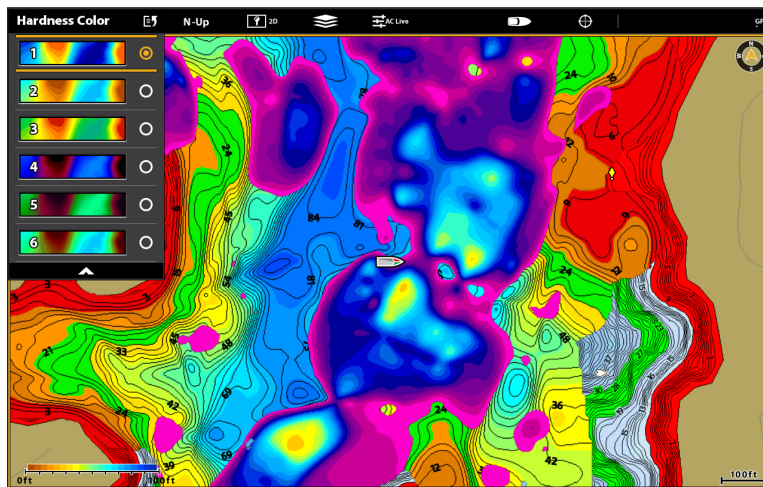

CUSTOMIZE THE VEGETATION DISPLAY SETTINGS

The Bottom Layer is displayed on top of the AutoChart Live map and can be displayed as bottom hardness or vegetation. Vegetation shows the sonar returns interpreted as vegetation on the Chart View. Both bottom hardness and bottom vegetation cannot be displayed at the same time in Chart View.

Show/Hide Vegetation

Show Vegetation

1. From the AutoChart Live menu, select Hardness Layer or Vegetation Layer. Tap, or press the ENTER key, to add a check mark to the box.
2. Select Vegetation.
3. **Adjust the Transparency:** Press and hold the slider, or press and hold the ENTER key, to adjust the setting.

Displaying the Vegetation Layer (Map Source: Humminbird)

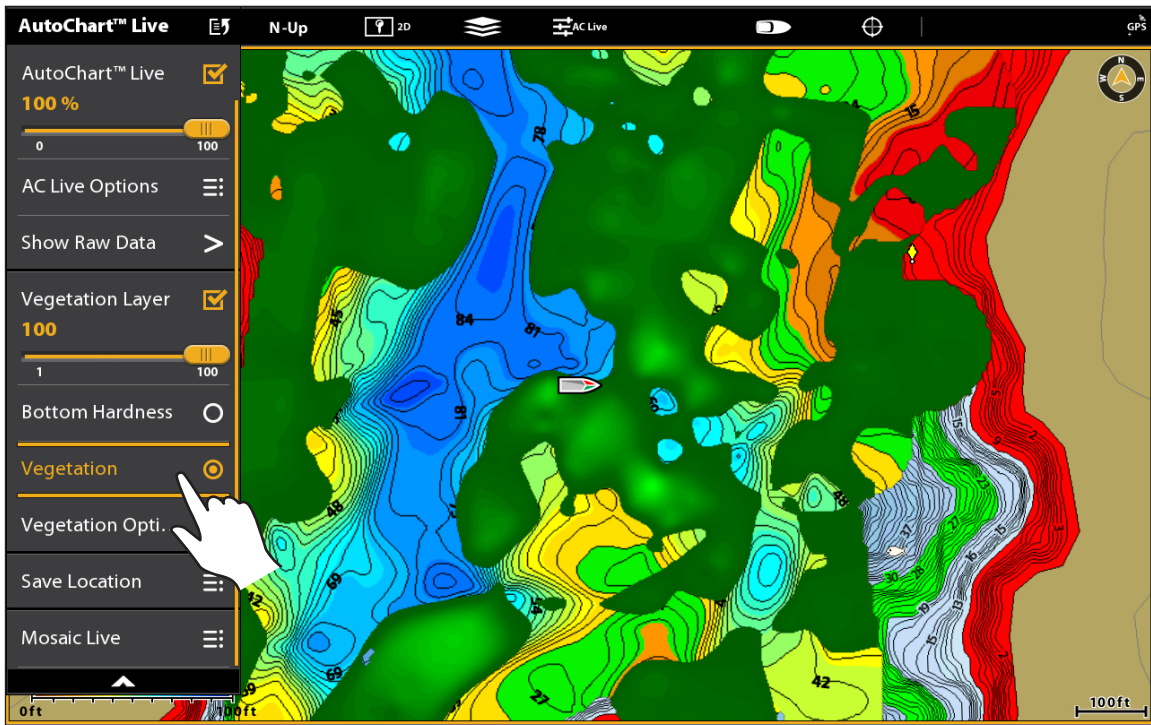

Hide Vegetation

1. From the AutoChart Live menu, select Vegetation Layer. Tap, or press the ENTER key, to remove the check mark from the box.

Adjust the Gain Offset

Use Gain Offset to tune the vegetation display. Vegetation will vary with the lake, season, or environment you are fishing, and you should adjust the Gain Offset as needed.

1. From the AutoChart Live menu, select Vegetation Options.
2. Select Gain Offset.
3. Press and hold the slider, or press and hold the ENTER key, to adjust the setting.

Adjust the Vegetation Range

You can adjust the range of vegetation shown on the chart by changing the minimum range and maximum range on the display. The range you select affects how the vegetation colors are displayed.

1. From the AutoChart Live menu, select Vegetation Options.
2. Select Min Vegetation. Press and hold the slider, or press and hold the ENTER key, to adjust the setting.
3. Select Max Vegetation. Press and hold the slider, or press and hold the ENTER key, to adjust the setting.

Adjusting the Vegetation Hardness Range (Map Source: Humminbird)

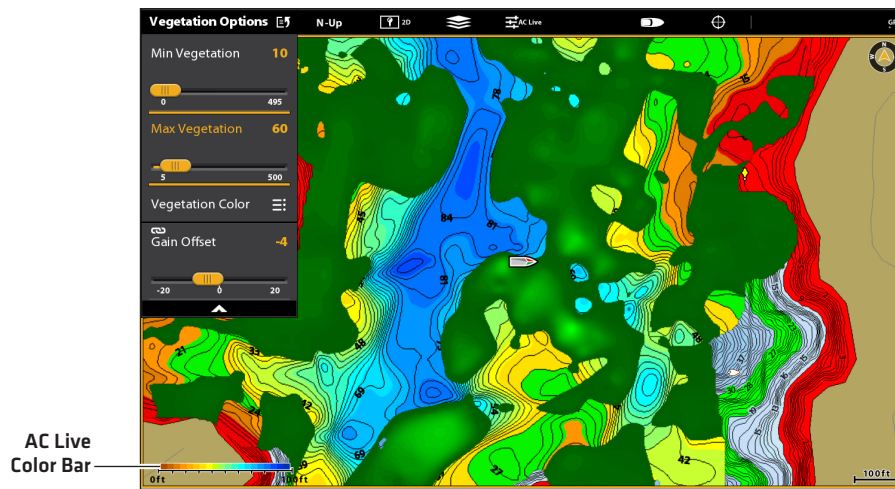



 **NOTE:** Use the AC Live Color Bar icon see the selected palette and, from left to right, the AutoChart Live depth range [low to high], Bottom Hardness range [soft to hard], or Vegetation range [soft to hard].

Change the Vegetation Colors

The Vegetation Color menu changes the colors used to display vegetation on the view. The color range is shown in the AC Live Color bar and is affected by the Min Vegetation and Max Vegetation settings. See *Adjust the Vegetation Range* for more information.

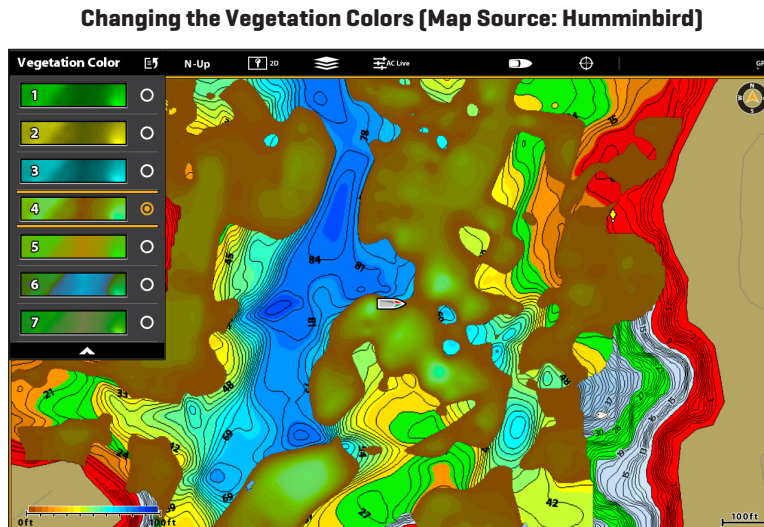
1. From the AutoChart Live menu, select Vegetation Options.
2. Select Vegetation Color.
3. Select a palette.



 **NOTE:** Use the AC Live Color Bar icon see the selected palette and, from left to right, the AutoChart Live depth range [low to high], Bottom Hardness range [soft to hard], or Vegetation range [soft to hard].

MOSAIC LIVE OVERVIEW

The Mosaic Live feature allows you to display Side Imaging data on the Chart View. A Mosaic can be displayed as an overlay while it is being recorded, and you can display saved Mosaics on the Chart View. Mosaic can also be used with a 360 Imaging transducer [separate purchase required].

Required Equipment: A Side Imaging transducer or a 360 Imaging transducer, and an SD Card to save recordings.

Map Source: Humminbird CoastMaster, Humminbird LakeMaster or Navionics

AutoChart PC: To display Mosaic Live data in AutoChart PC, use Sonar Recording. See the **Sonar Recording** section of this manual and the AutoChart PC Installation and Operations Guide for details [separate purchase required].

Accessories: To purchase a 360 Imaging transducer, AutoChart PC, or other related equipment, visit our Web site at humminbird.com.

FOR BEST PERFORMANCE

Many of the features that are available on the Side Imaging View or 360 Imaging View are available when a Mosaic is displayed on the Chart View.

If you are using a Side Imaging transducer or 360 Imaging transducer to display Mosaic Live data, it is important to consider the following tips for best performance:

Side Imaging Transducer

- **Vessel Speed:** 2 to 6 mph
- Straight line navigation
- Minimum turning time and wave turbulence
- To understand how Side Imaging works, review the **Side Imaging Overview** section of this manual.

360 Imaging Transducer

- **Vessel Speed:** 0 to 7 mph. The transducer pod should NOT be in the water during high speed travel.
- Straight line navigation
- Minimum turning time and wave turbulence
- To understand how 360 Imaging works, review the manual that is included with the transducer.

When recording the Mosaic, you should have only one Side Imaging sonar source pinging on your boat. To select a Side Imaging sonar source or confirm pinging, see **Set up your Humminbird Network: Select Sonar Sources**.

OPEN THE MOSAIC LIVE MENU

1. Press the HOME key.
2. Select a Chart View.
3. Tap Chart in the status bar, or press the MENU key once.
4. Select AutoChart Live.
5. Select Mosaic Live.

Record and Save a Mosaic

When you record a Mosaic, the control head displays the data as an overlay on the Chart View. If you are planning to use AutoChart PC, start a sonar recording before you start recording your Mosaic [see **Sonar Recording**].

The Mosaic must be saved when you are finished recording or before you power off the control head, or the data will be lost. See the instructions below.

1. Open the Mosaic Live Menu.
2. Select Record. Tap the on/off button, or press the ENTER key, to turn it on.

Speed: See **For Best Performance** in this section.

Display the Mosaic: Select Mosaic. Tap the check box, or press the ENTER key, to add a check mark to it.

3. **Save:** Open the Mosaic Live Menu. Select Save Mosaic.
4. **Select the Save Location:** Select Save Location. Select the location where an unlocked SD card is installed [SD Card 1 or SD Card 2].
5. Press the EXIT key.
6. Select Save.



WARNING! A Mosaic must be saved when you are finished recording or before you power off the control head, or the data will be lost. Save the recording before you turn off the Record menu.

7. **Stop Recording:** Select Record. Tap the on/off button, or press the ENTER key, to turn it off.

Recording a Mosaic in the Chart View

The screenshot displays the Mosaic Live software interface. On the left, a control panel includes a 'Record' toggle (ON), a 'Mosaic' checkmark, a '100%' progress indicator, 'Mosaic Live List', 'Save Mosaic', 'Sensitivity' (10), 'Contrast' (10), 'Contour Mode' (OFF), and 'Mosaic Options'. The main chart area shows a bathymetric map with a red 'Current Track' line, a 'bottom return' line, and a 'water column' area. A 'Current Track' popup shows '58.9 ft'. A scale bar indicates '50ft'. Coordinates at the bottom are '39°M 392.9ft' and 'N 34°14.937' W 83°54.785'.

Annotations on the left side of the image:

- turn on Record
- add a check mark to display the Mosaic on the Chart View

Annotations on the right side of the image:

- bottom return
- current track (red line)
- water column

CUSTOMIZE THE MOSAIC LIVE DISPLAY

You can display or hide a Mosaic, and you can adjust the Mosaic Live display settings while it is being recorded or when it is loaded on the Chart View.

Display/Hide the Mosaic Live Overlay

Use the instructions in this section to display or hide the Mosaic overlay. You can also adjust the transparency.

1. From the Mosaic Live menu, select Mosaic.
2. **Display:** Tap the check box, or press the ENTER key, to add a check mark to it.
Hide: Tap the check box, or press the ENTER key, to remove the check mark.
3. **Adjust the Overlay Transparency:** Press and hold the slider, or press and hold the ENTER key.

Adjusting the Mosaic Overlay Transparency

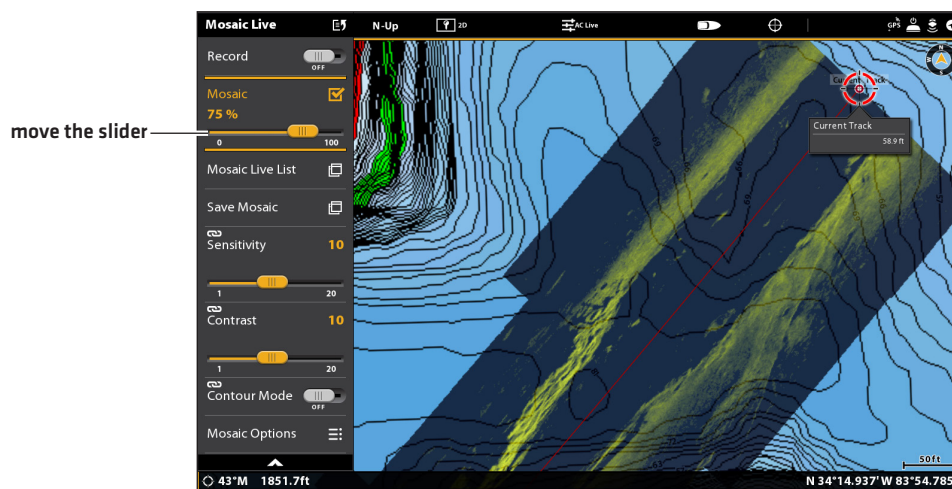

Load a Saved Mosaic

Use the instructions in this section to display a saved Mosaic. Mosaics can be displayed from a SD Card.

1. From the Mosaic Live menu, select Mosaic Live List.
2. Select the location where the SD card is installed [SD Card 1 or SD Card 2].
3. Select the Mosaic file.

Change the Palette

The Palette menu changes the colors used to display the Mosaic. The palette can be changed while a Mosaic is being recorded, or it can be applied to a saved Mosaic on the Chart View.

1. From the Mosaic Live menu, select Mosaic Options.
2. Select Palette.
3. Select a color palette.

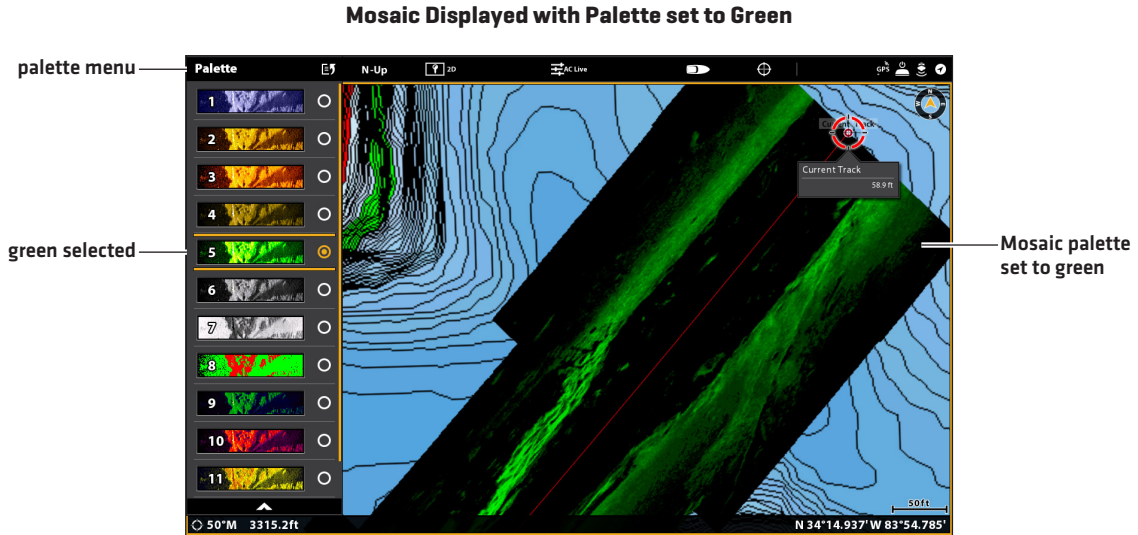

Change the Drawing Mode

You can also change how the Mosaic is drawn on the Chart View while it is being recorded.

1. From the Mosaic Live menu, select Mosaic Options.
2. Select Drawing Mode.
3. Select one of the following options:

| | |
|---------------------|---|
| Overwrite | If the boat travels over the same area, the old data will be deleted, and the most recent data will be displayed. |
| Blend | If the boat travels over the same area, AutoChart LIVE will mix the old data and new data on the display. |
| Keep Maximum | If the boat travels over the same area, AutoChart LIVE will prioritize the strong returns over the weak returns on the display. |
| Keep Nearest | If the boat travels over the same area, AutoChart LIVE will display the data closest to the boat. |

Turn on/off Gain Correct

Turn on Gain Correct to automatically tune the transducer signal and filter any clutter that may show up in the Mosaic Live data.

1. From the Mosaic Live Menu, select Mosaic Options.
2. Select Gain Correct.
3. Tap the on/off button, or press the ENTER key, to turn it on or off.

Adjust the Sensitivity and Contrast

The sensitivity and contrast can be adjusted while the Mosaic is being recorded or it can be adjusted when a saved Mosaic is loaded onto the Chart View.

Adjusting the Sensitivity and Contrast

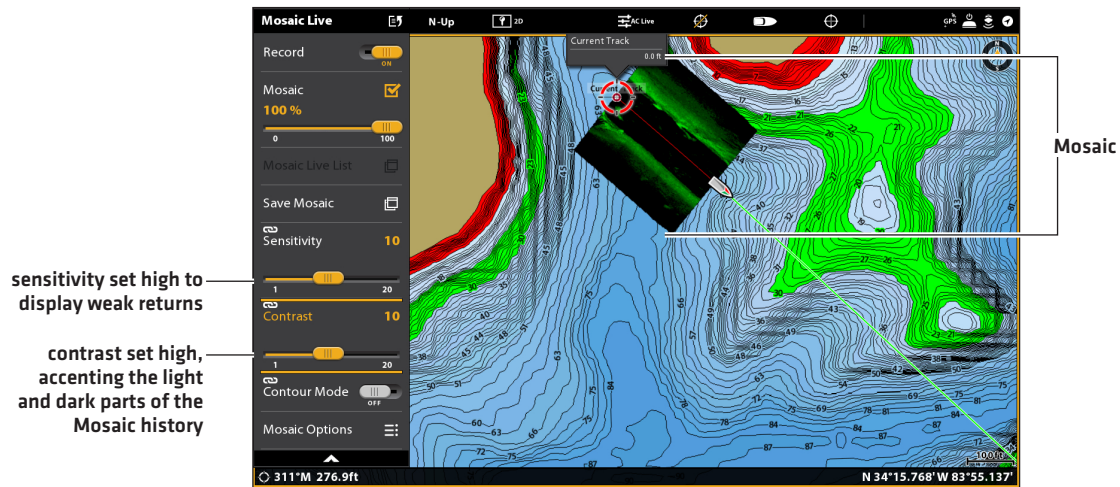

Adjust the Sensitivity and Contrast

1. From the Mosaic Live Menu, select Sensitivity or Contrast.
2. Press and hold the slider, or turn the Rotary dial, to adjust the setting.

| | |
|-------------|--|
| Sensitivity | Sensitivity controls how much detail is shown on the display and will adjust the sensitivity of all sonar frequencies. Decrease the sensitivity to eliminate the clutter from the display that is sometimes present in murky or muddy water. When operating in very clear water or greater depths, increase the sensitivity to see weaker returns that may be of interest. |
| Contrast | Adjust the Contrast setting to accent the light and dark parts of the Mosaic data to provide greater definition. |

Turn on/off Contour Mode

Contour Mode controls how the water column is displayed in the Mosaic. The location of a target in the Mosaic is influenced by the Contour Mode setting. For more information, see *Customize the Side Imaging View: Turn on/off Contour Mode*.

When Contour Mode turned off, the water column is displayed on the view. The location of a target on the display is based on the slant range to the target.

When Contour Mode is turned on, the bottom is graphed at a constant point on the display, regardless of changes in depth. The Side Imaging beams are divided by a vertical line. The water column is removed from the view, which allows the display to show targets at their linear horizontal distance. The location of a target may be easier to interpret when the water column is removed.

Turn on/off Contour Mode

1. From the Mosaic Live menu, select Contour Mode.
2. Tap the on/off button, or press the ENTER key, to turn it on/off.

Off: The water column is displayed.

On: The water column is hidden.

AUTOPILOT OVERVIEW

The Humminbird autopilot [SC 110] connects to the control head network. The Humminbird autopilot system requires a separate purchase. For additional autopilot products and equipment, visit our Web site at humminbird.com.

SC 110 Humminbird Autopilot Nav Mode with Chartplotter Input

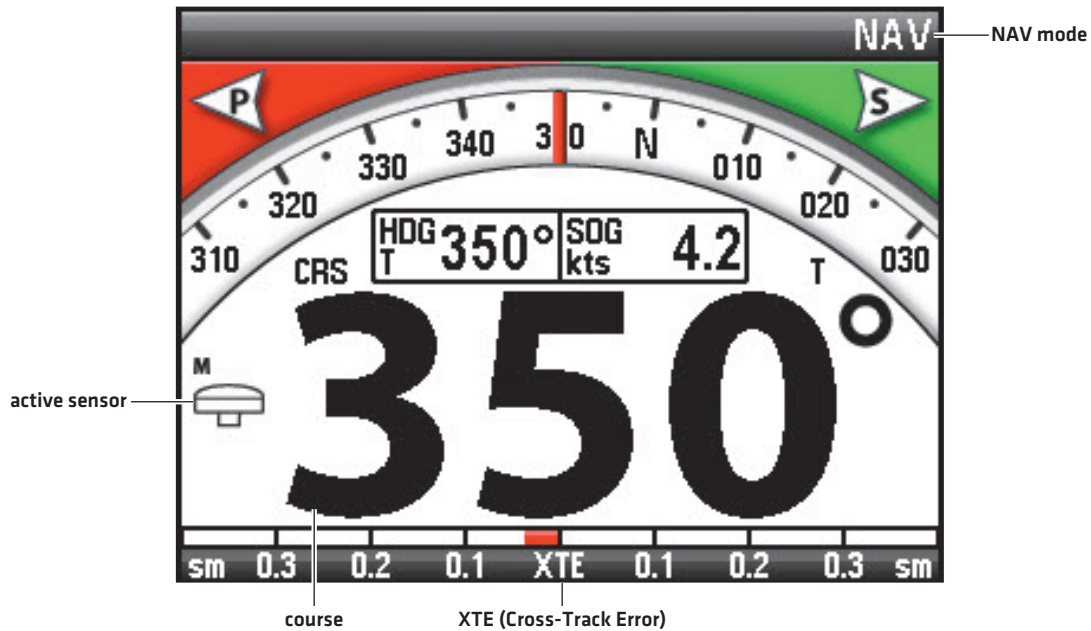

⚠ WARNING! It is the operator's responsibility to make prudent decisions regarding personal safety and the operation of the vessel. Do NOT leave the autopilot unattended while it is steering the vessel. Watch for obstacles and potential hazards at all times. Be prepared to respond to changing conditions and take manual control of the vessel as required.

⚠ WARNING! Do NOT use the autopilot where there may be shallow water, obstacles, or when manual navigation is required, especially in the following situations:

- while navigating or maneuvering in shallow waters or dangerous seabeds,
- while entering or exiting harbor, mooring, or setting sail,
- while traveling at high speed,
- in heavy traffic areas, near breakwaters, canals,
- or while encountering any potential obstacles.

Send Navigation Data to the Autopilot

When a route is started from the control head, it will communicate with the autopilot to tell it which way to turn to get on course. The Autopilot Navigation menu must be turned on to enable this feature on the control head.

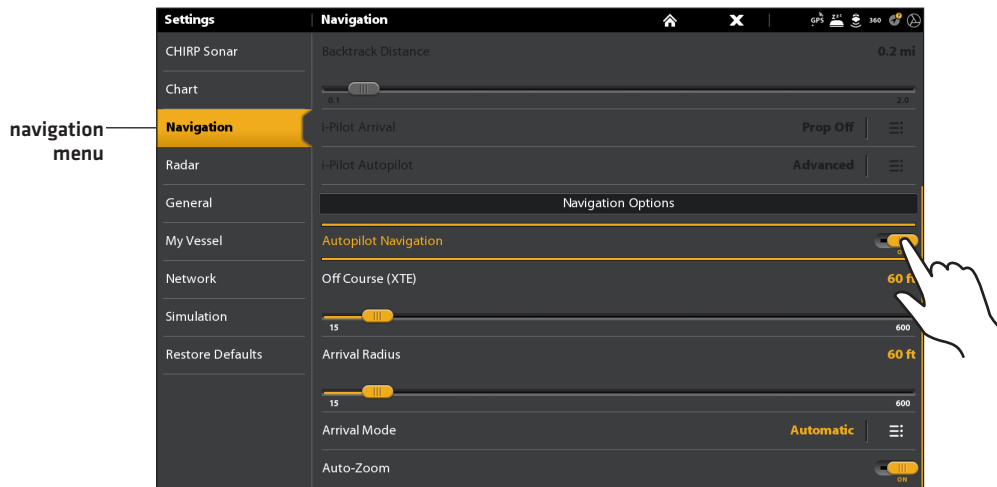

Enable Autopilot Navigation

Use the following instructions to enable Autopilot on the control head.

1. See *Installation Information: Configure the Control Head, Set up Autopilot*. The Autopilot must be set up correctly with the control head when it is first installed.
2. Press the HOME key.
3. Select Settings > Navigation.
4. Select Autopilot Navigation.
5. Tap the on/off button, or press the ENTER key, to turn it on.

Disable Autopilot Navigation

Use the following instructions to disable autopilot navigation. When Autopilot is disabled, the control head will not send data to the autopilot.

1. Press the HOME key.
2. Select Settings > Navigation.
3. Select Autopilot Navigation.
4. Tap the on/off button, or press the ENTER key, to turn it off.

RADAR OVERVIEW

The radar scanner must be connected to the control head to enable radar features. Some of the features also require a compass/heading sensor.

Some of the instructions in the following sections vary depending on the connected radar model. Refer to the instructions for your radar model as follows:

- Humminbird CHIRP Radar
- Humminbird Radar: RH 44, RH 45, AS 12RD2KW, and AS 21RD4KW

 **NOTE:** To configure the Humminbird radar after installation or equipment repair, see **Installation Information: Configure Humminbird Radar**. Humminbird CHIRP radar does not require configuration.

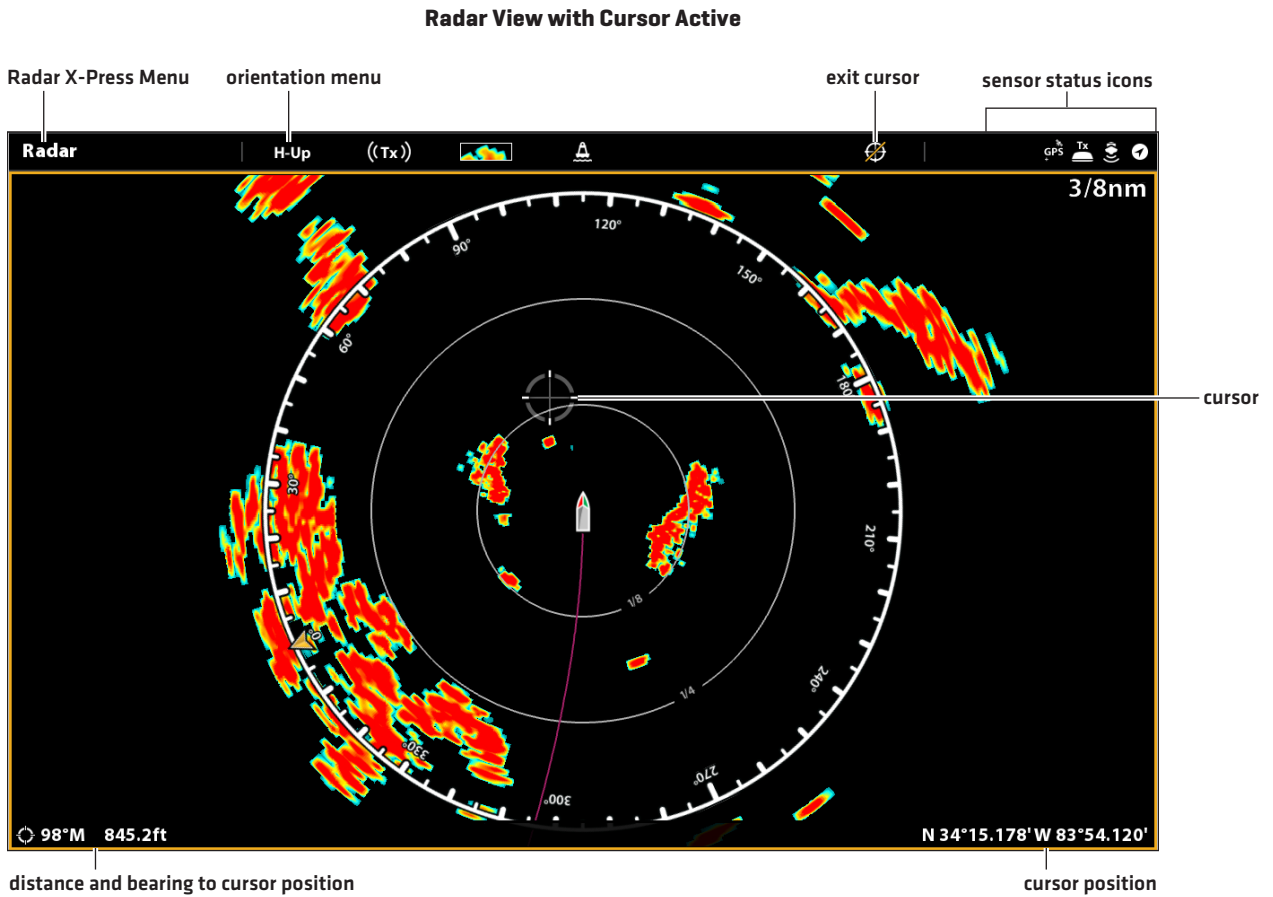

Tap to Activate the Cursor

OR

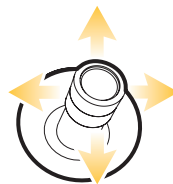

Move the Joystick to Activate the Cursor



Open the Cursor Menu

RADAR TRANSMISSION SETTINGS

The Radar Transmit menu can be accessed from the Power X-Press Menu, the Radar X-Press Menu, and the Radar tab in Settings.

Start/Stop Radar Transmission

Start Transmission: Humminbird CHIRP Radar

1. **Power On:** Turn on the radar power source [breaker or switch].
2. **Open the Power X-Press Menu:** Tap the top, right corner of the status bar.

OR

Press the POWER key.

3. Under Radar, select Standby.
4. **Start Transmission:** Repeat step 2. Under Radar, select Transmit.

Start Transmission: Humminbird Radar

1. **Power On:** Turn on the radar power source [breaker or switch].
2. Tap the top, right corner of the status bar.

OR

Press the POWER key.

3. Select Radar Transmit > On.

Stop Transmission

1. Tap the top, right corner of the status bar.

OR

Press the POWER key.

2. **Humminbird CHIRP Radar:** Under Radar, select Off.
Humminbird Radar: Select Radar Transmit > Off.
3. **Power Off:** Turn off the power source from the breaker or switch.

Starting Humminbird CHIRP Radar Transmission

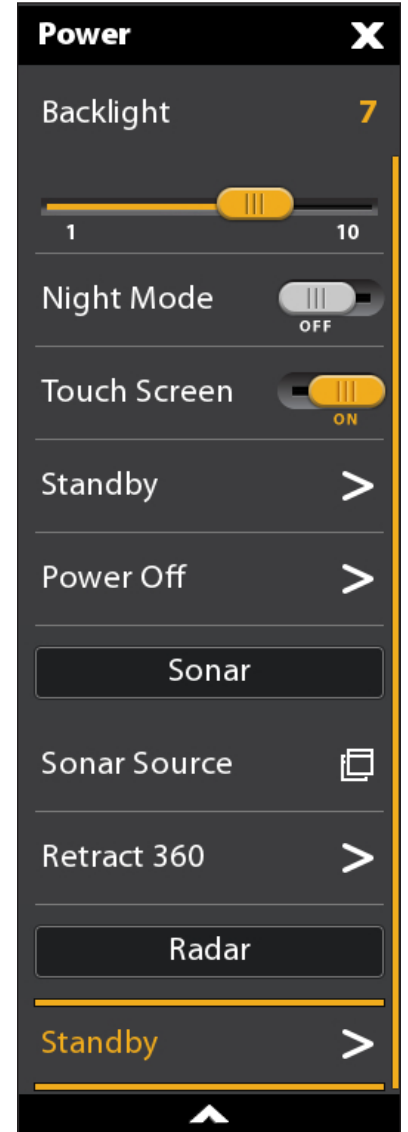

Select the Radar Mode (Humminbird CHIRP Radar only)

For optimum radar operation, select the radar mode for your current environment and weather. See the instructions below.

1. With a Radar View displayed on the screen, tap Radar in the status bar, or press the MENU key.
2. Select Mode.
3. Select from the menus shown below.

| | |
|-----------------|--|
| Harbor | Use in harbors and most inland areas. |
| Coastal | Use near the shoreline. |
| Offshore | Use when navigating several miles away from the shoreline. |
| Weather | Use when tracking rain and/or cloud cover. |



QUICK TIP! You can also select this menu on the status bar.

Set up Timed Transmission Settings

Set up Timed Transmission Settings: Humminbird CHIRP Radar

1. Press the HOME key.
2. Select Settings.
3. Select Radar.
4. Select Timed Transmit, and turn it on.
5. Select Transmit Cycles. Select the number of cycles that the radar will transmit during Timed Transmission mode.
6. Select the Back icon to return to the previous menu, or press the EXIT key.
7. Select Standby Time. Set the amount of time that the radar will pause between transmissions in Timed Transmission mode.

Set up Timed Transmission Settings: Humminbird Radar

1. Press the HOME key.
2. Select Settings.
3. Select Radar.
4. Select Timed Transmit, and turn it on.
5. Select Transmit Time. Set the the amount of time that the radar will transmit during Timed Transmission mode.
6. Select the Back icon to return to the previous menu, or press the EXIT key.
7. Select Standby Time. Set the amount of time that the radar will pause between transmissions in Timed Transmission mode.

ADJUST THE TRANSMISSION RANGE

The scanner transmission range can be adjusted from the X-Press Menu or by pressing the +/- ZOOM keys. The range setting affects all the Radar Views in the control head. The control head will default to the largest chosen area from all of the Radar Views.

Adjust the Range with the Keypad

1. **Keypad:** Press the [+] key or [-] key to increase or decrease the transmission range.

Adjust the Range with the Menu System

This menu is available in Custom Mode [see *The Menu System: Change the User Mode*].

1. With the Radar View displayed on-screen, tap Radar in the status bar, or press the MENU key once.
2. Select Transmit Range.
3. Select a range from the menu.

RADAR ALARMS

When an alarm is turned on, it will use the control head's default setting to provide an alert, and you can also adjust the settings used to trigger an alarm. If you will be tracking targets with MARPA or AIS, see **AIS and MARPA**.

Turn on Radar Alarms

1. Press the HOME key.
2. Select Alarms.
3. Select Alarms > Targets.
4. Under Radar, select an alarm. Tap the on/off button, or press the ENTER key, to turn it on.

| | |
|----------------------------|--|
| Dangerous Target | Turn on Dangerous Target to receive an alert if a MARPA target tracked as dangerous is detected in the radar transmission range. See AIS and MARPA for more information. |
| Lost Target | Turn on Lost Target to receive an alert if a tracked MARPA target has changed to lost in the radar transmission range. A target may be lost if its signal has not been received in the last 30 seconds. See AIS and MARPA for more information. |
| Guard Zone [Sector] | Turn on Guard Zone [Sector] to receive an alert when a radar return or MARPA target enters the guard zone sector. See Set the Guard Zone for details. |
| Guard Zone [Circle] | Turn on Guard Zone [Circle] to receive an alert when a radar return or MARPA target enters the guard zone circle. See Set the Guard Zone for details. |

To adjust the Transmission range, see **Adjust the Transmission Range**.

To set the Guard Zone, see **Set the Guard Zone**.



NOTE: You can also turn on AIS alarms from this menu. See **AIS and MARPA** for more information.

Set the Guard Zone

If you turned on the Guard Zone alarms in the Alarms tool, use this section to display the Guard Zone and adjust the settings that will trigger the alarm. The settings in this section are optional. You can turn on the Guard Zone alarms and receive alerts using the control head default settings. **This menu is available in Custom Mode** [see *The Menu System: Change the User Mode*].

1. Press the HOME key.
2. Open a Radar View.
3. Start Radar Transmission.
4. Tap Radar in the status bar, or press the MENU key once.
5. Select Guard Zone.
6. Turn on Circle or Sector. [Tap the on/off button, or press the ENTER key, to turn it on.]
7. Select Adjust Circle or Adjust Sector.

Circle [radius]: Use the Joystick to adjust the radius. Press the ENTER key to set the guard zone. A preview of the guard zone will be highlighted between the dotted lines.

Sector [angular]: Use the Joystick to move the cursor to a position on the Radar View. Press the ENTER key to select the first corner of the guard zone. Repeat to select the second corner of the guard zone. A preview of the guard zone will be highlighted between the dotted lines.

8. Select Alarm Sensitivity to adjust the sensitivity to targets in the guard zone. Press and hold the slider, or turn the Rotary dial, to adjust the range, where 1 = low sensitivity and 100 = high sensitivity.

Turn off the Guard Zone

1. Press the HOME key.
2. Open a Radar View.
3. Tap Radar in the status bar, or press the MENU key once.
4. Select Guard Zone.
5. Select Circle, and turn it off.

Select Sector, and turn it off.

Setting the Guard Zone Sector (Keypad)

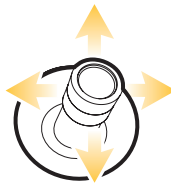
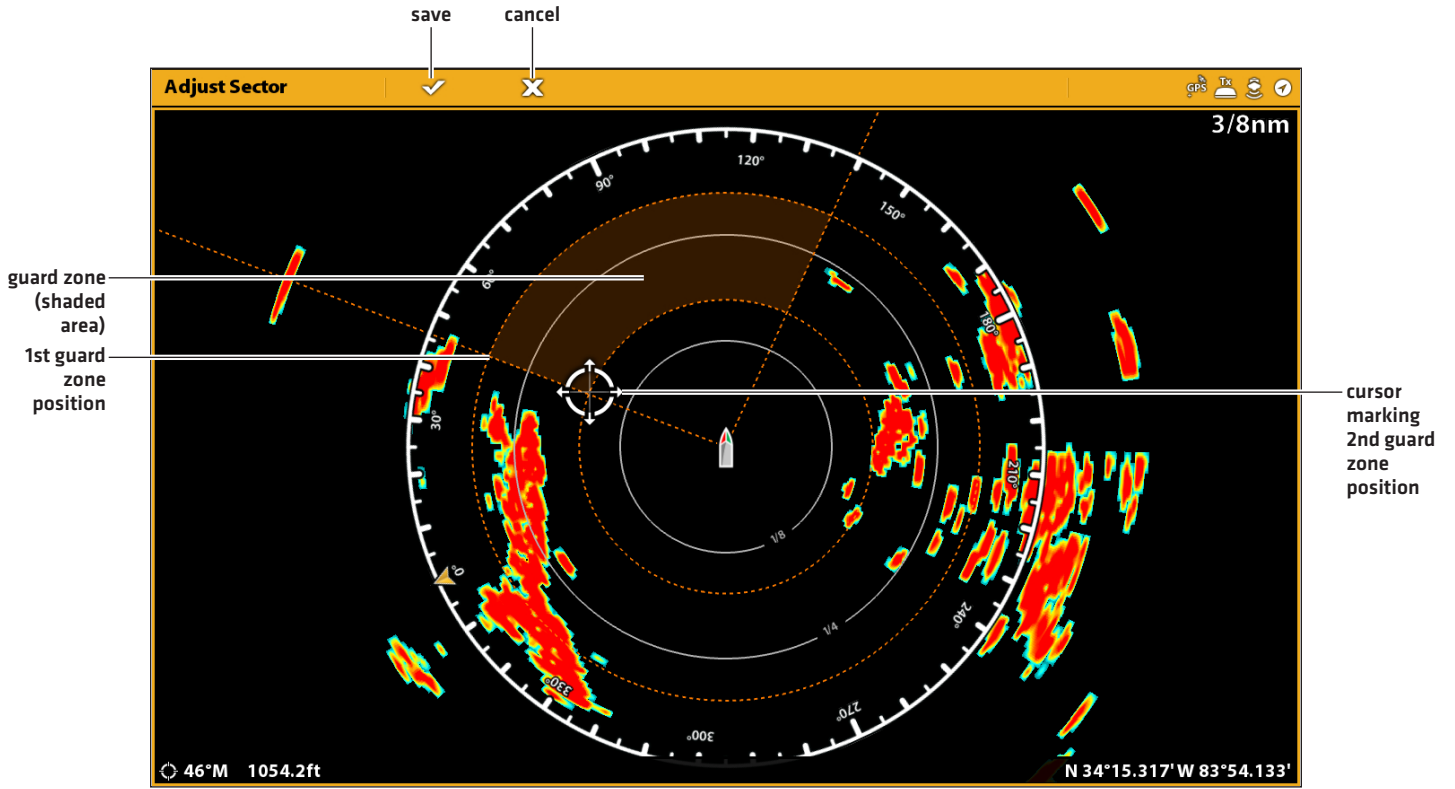

Select a Position



Confirm

CUSTOMIZE THE RADAR VIEW

The settings in this section are optional. You can use the default settings for the Radar View, or you can customize it with your preferences. See **Views** for more information.

OPEN THE RADAR PREFERENCES MENU

The Preferences menu allows you to set the Radar View orientation, vessel offset, and display colors. For more information about view preferences, see **Views**.

1. With a Radar View displayed on-screen, tap Radar in the status bar, or press the MENU key once.
2. Select Radar Options.
3. Select Preferences.

Set the Chart Orientation

Use the Preferences menu to change the chart orientation. You can also select the orientation menu on the status bar.

1. From the Preferences menu, select Orientation.
2. Select an orientation to apply to the chart.

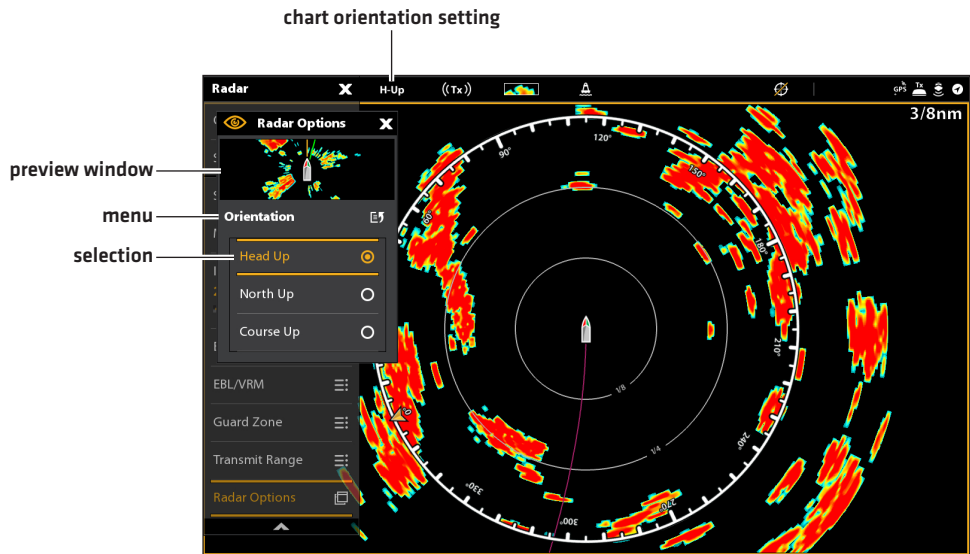

| | |
|--------------------------------|---|
| Head Up | The vessel's current heading points up, and the chart rotates around the vessel icon so that it always points up on the view. The heading is provided by the connected compass/heading sensor. If a compass is not connected, the heading will be calculated using the GPS receiver's COG [Course Over Ground]. |
| North Up [compass required] | True north is shown at the top of the display and the vessel rotates on the screen to point towards the current heading. |
| Course Up | During navigation, the projected course is shown at the top of the view. Objects ahead of the vessel are drawn above the vessel. When the vessel is not navigating, the course-up reference is provided by a one-time COG [Course Over Ground] calculation. |

Change Radar Display Colors

The Radar Colors menu changes the palette used to display radar returns. The Background Colors menu changes the color of the background on Radar Views.

1. From the Preferences menu, select Radar Colors or Background Colors.
2. Select a color palette or background color.

 **NOTE:** The available options may vary depending on your radar model.

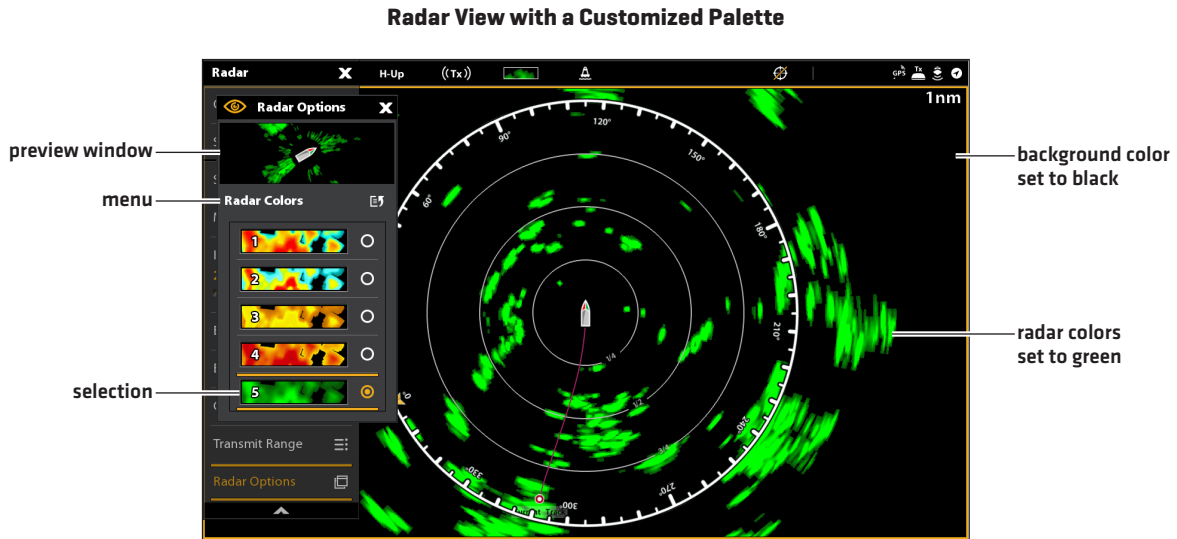

Radar Colors: The palettes in this menu are listed weakest return to strongest return, as follows:

| | |
|---------|---|
| Red | dark green [weak], light green [medium], orange [strong], red [strongest] |
| Yellow | dark green[weak], green [medium], yellow [strong] |
| Green | dark green [weak], green [medium], light green [strong] |
| Magenta | red [weak], crimson [medium], magenta [strong], pink [strongest] |

CHANGE THE RADAR VIEW DATA OVERLAYS

Use the Overlays menu to display or hide information on the view. In a Radar View, you can display or hide range rings, range symbols, the compass ring, north indicator, and EBL/VRM readout box. You can also display or hide vessel data, AIS and MARPA targets, navigation data, and the data overlay. The available menu options are determined by the equipment connected to the control head network. Also, see **Views** for more information about Overlays.

1. With a Radar View displayed on-screen, tap Radar in the status bar, or press the MENU key once.
2. Select Radar Options.
3. Select Overlays.
4. Tap the menu or use the Joystick to select an item and add a check mark. [check mark = visible, blank = hidden].

Display Range Rings

1. From the Overlays menu, select Range Rings.
2. Tap the menu, or press the ENTER key, to add a check mark to the box.

Display Vessel Icons

The Vessel Overlay allows you to display the vessel icon with other visual information such as the heading line, COG [Course over Ground], Rate of Turn, and Drift Limit.

1. From the Overlays menu, select Vessel.
2. Select Show. Tap the on/off button, or press the ENTER key, to turn it on.
3. Tap the menu name, or press the ENTER key, to add a check mark to the box.

Display AIS and MARPA Targets

The Targets Overlay displays or hides AIS targets, MARPA targets, and the Safe Zone. An AIS must be connected to enable AIS targets on the view. See **AIS and MARPA** for more information.

1. From the Overlays menu, select Targets.
2. Select Show. Tap the on/off button, or press the ENTER key, to turn it on.
3. Select MARPA and/or AIS, and add a check mark to each box.
4. To display the Safe Ring, tap the menu name, or press the ENTER key, to add a check mark to the box.

Display Navigation Data

Use the Nav Data Overlay to display waypoints, routes, and tracks on the Radar View. See **Introduction to Navigation** for more information.

1. From the Overlays menu, select Nav Data.
2. Select Show. Tap the on/off button, or press the ENTER key, to turn it on.
3. Tap the navigation data types, or press the ENTER key, to add a check mark to the box.

Display Digital Readouts as an Overlay

Digital readout data can be displayed as an overlay, and it can be displayed in the data bar. For more information about data overlays, see [Views](#).

1. From the View Options menu, select Data Overlays.
2. Tap the on/off button, or press the ENTER key, to turn it on.
3. Tap the menu name, or use the Joystick, to select an item.

Radar View with Overlays Displayed

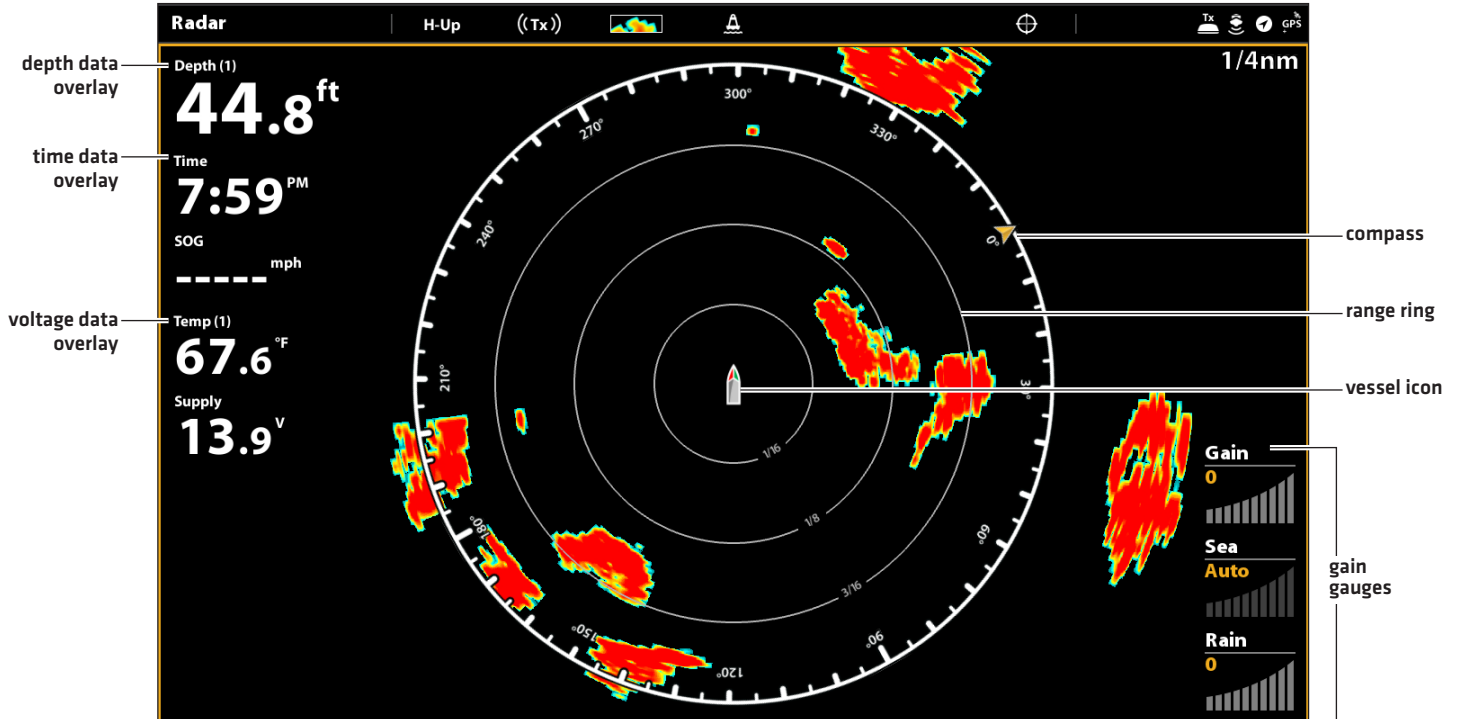

ADJUST RADAR SIGNAL SETTINGS

Use the settings in this section to filter the returns on the display or increase the amount of returns on the display.

Adjust the Gain Setting

Use the Gain setting to adjust the sensitivity of the radar. Increase the gain to see more targets on the view, and decrease the gain to reduce the clutter caused by rain or snow.

1. With a Radar View displayed on-screen, tap Radar in the status bar.

OR

Press the MENU key.

2. Select Settings.
3. Select Gain.
4. Tap the Auto/M button to select Auto or Manual, or press the ENTER key.

Manual: If you select Manual, press and hold the slider, or press and hold the ENTER key, to adjust the setting.



QUICK TIP! You can also change this setting by turning the Rotary dial. See the illustration below.

Changing the Gain Setting Using the Rotary Dial

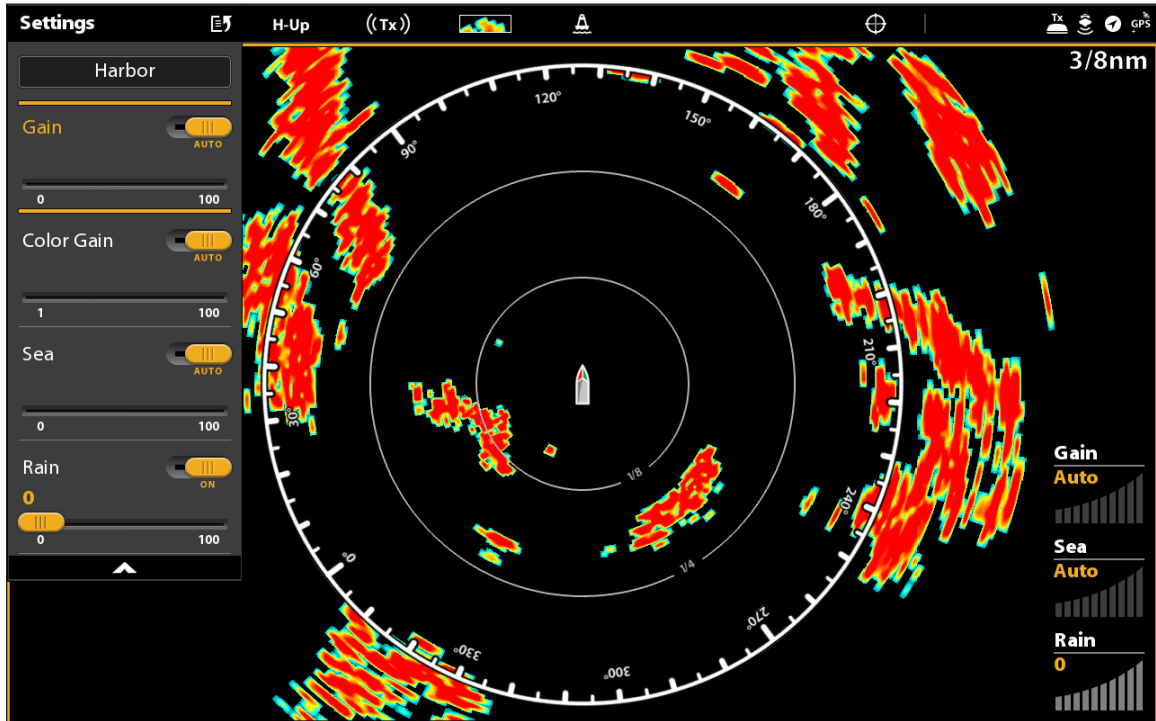

Select a Setting

Adjust the Color Gain Setting (Humminbird CHIRP Radar only)

Use Color Gain to adjust the contrast of the radar returns on the display.

1. With a Radar View displayed on-screen, tap Radar in the status bar.

OR

Press the MENU key.

2. Select Settings.
3. Select Color Gain.
4. Tap the Auto/M button to select Auto or Manual, or press the ENTER key.

Manual: If you select Manual, press and hold the slider, or press and hold the ENTER key, to adjust the setting.

Adjust the Sea Clutter Setting

Use the Sea Clutter setting to reduce the clutter that may appear on the view during rough sea conditions.

1. With a Radar View displayed on-screen, tap Radar in the status bar.

OR

Press the MENU key.

2. Select Settings.
3. Select Sea.
4. Tap the Auto/M button to select Auto or Manual, or press the ENTER key.

Manual: If you select Manual, press and hold the slider, or press and hold the ENTER key, to adjust the setting.

Adjust Rain Clutter Settings

Use the Rain Clutter setting to reduce the clutter on the view caused by rain or snow.

1. With a Radar View displayed on-screen, tap Radar in the status bar.

OR

Press the MENU key.

2. Select Settings.
3. Select Rain.
4. Tap the on/off button to select On, or press the ENTER key. Press and hold the slider, or press and hold the ENTER key, to adjust the setting.

Adjust Interference Rejection

Use the Interference Rejection setting to reduce the noise or interference from other transmitting radars in the area.

1. With a Radar View displayed on-screen, tap Radar in the status bar.

OR

Press the MENU key.

2. Select Interference Rejection.
3. Press and hold the slider, or press and hold the ENTER key, to adjust the setting.

EBL/VRM

Use EBL [Electronic Bearing Range] and VRM [Variable Range Ring] to measure the distance and bearing between any two targets on the Radar View.

The EBL and VRM can be set as a pair, and you can set two pairs. The marker is tied to the center of the vessel. As the vessel's position and heading move, the EBL/VRM also moves.

This menu is available in Custom Mode [see *The Menu System: Change the User Mode*].

Create an EBL/VRM

1. With a Radar View displayed on-screen, tap Radar in the status bar.

OR

Press the MENU key.

2. Select EBL/VRM.
3. Select EBL/VRM, and turn it on.
4. Select Adjust.
5. Use the Joystick to move the cursor until it is positioned over the chosen EBL/VRM intersection.
6. Press the ENTER key.

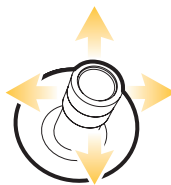
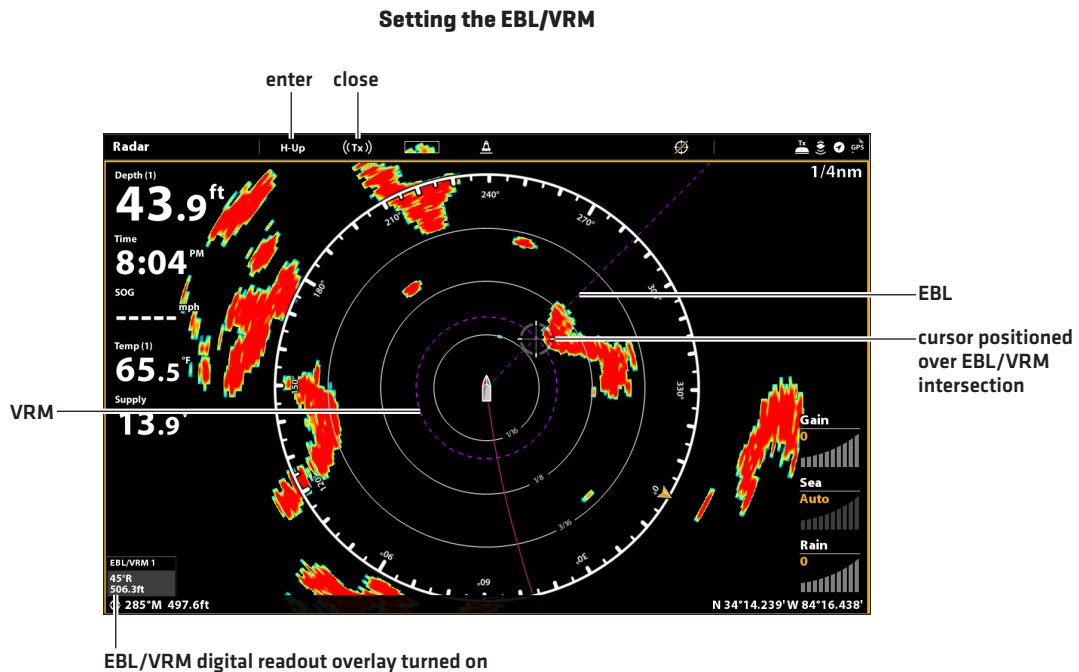

Select a Position



Enter

Edit an EBL/VRM

1. With a Radar View displayed on-screen, tap Radar in the status bar.

OR

Press the MENU key.

2. Select EBL/VRM.
3. Under EBL/VRM, select Adjust.
4. Use the Joystick to move the cursor until it is positioned over the chosen EBL/VRM intersection.
5. Press the ENTER key.

Turn off an EBL/VRM

1. With a Radar View displayed on-screen, tap Radar in the status bar.

OR

Press the MENU key.

2. Select EBL/VRM.
3. Select EBL/VRM, and turn it off.

NAVIGATION IN RADAR VIEW

You can mark waypoints and start navigation from the Radar View. See *Introduction to Navigation* for more features and information.



NOTE: To display navigation data on the Radar View, see *Change the Radar View Data Overlays: Display Navigation Data*.

Mark a Waypoint

There are a variety of ways to mark a waypoint in the Radar View. The basic instructions are shown here. See *Introduction to Navigation* for more features and information.

Mark a Waypoint at the Vessel Position

Touch Screen

1. Tap Radar in the status bar.
2. Select Mark.
3. Select Waypoint.

Keypad

1. Press the MARK key twice.

Mark a Waypoint at the Cursor Position

Touch Screen

1. Press and hold a position on the Radar View.
2. Select Waypoint.

Keypad

1. Use the Joystick to move the cursor to a position on the chart.
2. Press the MARK key twice.

Start Navigation

There are a variety of ways to start navigation in the Radar View. The basic instructions are shown here. See *Introduction to Navigation* for more features and information.

Start Quick Route Navigation

Touch Screen

1. Tap Radar in the status bar.
2. Select Go To.
3. Select Quick Route.
4. Tap the chart in the positions where you want to mark a route point.

Undo Last Route Point: Tap the Back icon.

Cancel Route Creation: Tap the X icon.

5. To start navigation, tap the check icon in the status bar.

Keypad

1. Press the GO TO key.
2. Select Quick Route.
3. Use the Joystick to move the cursor to a position or waypoint. Press the Joystick to mark the first route point.
4. Repeat Step 3 to connect more than one route point.

Undo Last Route Point: Press the EXIT key once.

Cancel Route Creation: Press and hold the EXIT key.

5. To start navigation, press the ENTER key.

AIS AND MARPA

AIS and MARPA allow the control head to display targets on the Chart and Radar Views. While AIS and MARPA share many of the same menus and functions, some of the requirements and operations are different for each feature.

AIS: Targets within the AIS VHF transmission range are displayed on Chart and Radar Views. An AIS and a compass/heading sensor must be connected to the control head to enable this feature. The control head can track up to 100 targets at the same time. If more than 100 targets are reported by the AIS equipment, the first 100 targets closest to your vessel will be shown. See **AIS Overview** for more information.

MARPA: Targets are displayed and tracked on the Radar View. A Radar scanner and compass/heading sensor must be attached to the control head to enable MARPA, and the control head can track up to 20 targets at the same time. See **MARPA Targets** for more information.

AIS AND MARPA ALARMS

When an alarm is turned on, an alert will sound or display on the control head to indicate the threshold has been exceeded. The alarm will use the control head's default setting to provide the alert, and you can also adjust the alarm settings used to trigger an alarm. The alarms for AIS and MARPA are also affected by the Guard Zone. To set the Guard Zone, see **Radar Alarms**.

Turn on AIS Alarms

1. Press the HOME key.
2. Select Alarms.
3. Select Alarms > Targets.
4. Under AIS, select an alarm and turn it on. [Tap the on/off button, or press the ENTER key, to turn it on.]

| | |
|----------------------------|--|
| Dangerous Target | Turn on Dangerous Target to receive an alert if a dangerous target is detected within the AIS transmission range. |
| Lost Target | Turn on Lost Target to receive an alert if a target has changed to lost within the AIS transmission range. A target may be lost if its signal has not been received in the last 8 minutes. |
| Guard Zone [Sector] | Turn on Guard Zone [Sector] to receive an alert when a target enters the guard zone sector. See Radar Alarms to set the Guard Zone. |
| Guard Zone [Circle] | Turn on Guard Zone [Circle] to receive an alert when a target enters the guard zone circle. See Radar Alarms to set the Guard Zone. |

Turn on MARPA Alarms

For a MARPA target to be detected, the radar must be transmitting and a return must be identified as a target. The settings in this section are shared with Radar.

1. Press the HOME key.
2. Select Alarms.
3. Select Alarms > Targets.
4. Under Radar, select an alarm and turn it on. [Tap the on/off button, or press the ENTER key, to turn it on.]

| | |
|----------------------------|---|
| Dangerous Target | Turn on Dangerous Target to receive an alert if a MARPA target tracked as dangerous is detected in the radar transmission range. |
| Lost Target | Turn on Lost Target to receive an alert if a tracked MARPA target has changed to lost in the radar transmission range. A target may be lost if its signal has not been received in the last 30 seconds. |
| Guard Zone [Sector] | Turn on Guard Zone [Sector] to receive an alert when a radar return or MARPA target enters the guard zone sector. See Radar Alarms to set the Guard Zone. |
| Guard Zone [Circle] | Turn on Guard Zone [Circle] to receive an alert when a radar return or MARPA target enters the guard zone circle. See Radar Alarms to set the Guard Zone. |

Set the Safe Zone

Use the Safe Zone to set how close targets may approach your vessel. If a target crosses into the Safe Zone, its status will change to Dangerous. You can set the size of the safe zone around the vessel in nautical miles or time. To display the Safe Zone on the Radar View or Chart View, see **Display the Safe Zone**.

1. Press the HOME key.
2. Select the Targets tool.
3. Select Settings > Safe Zone [Range] or Safe Zone [Time].

Safe Zone [Range]: Select the closest point of approach by another vessel [based on CPA [Closest Point of Approach] and TCPA [Time to Closest Point of Approach]]. The amount is estimated in nautical miles, and the value determines the safe zone radius.

Safe Zone [Time]: Select the closest point of approach, measured in time.

AIS AND MARPA DISPLAY SETTINGS

Display AIS and MARPA Targets

Use the following instructions to display AIS or MARPA Targets on the Chart View or Radar View.



NOTE: If Automatic AIS Tracking is turned on, but you do not see AIS targets on the chart and Radar Views, use these instructions to make sure targets are set to display in the Overlays menu.

1. With a Radar View or Chart View displayed on-screen, tap Radar or Chart in the status bar.

OR

Press the MENU key once.

2. Select Radar Options or Chart Options.
3. Select Overlays.
4. Select Targets.
5. Select Show, and turn it on.
6. Select MARPA and/or AIS, and add a check mark to each box.

Display the Safe Ring

The Safe Ring is displayed on the Radar View or Chart View to indicate the safe zone range. The range is highlighted in red. To change the range of the safe zone, see *AIS and MARPA Alarms: Set the Safe Zone*.

1. With a Radar View or Chart View displayed on-screen, tap Radar or Chart in the status bar.

OR

Press the MENU key once.

2. Select Radar Options or Chart Options.
3. Select Overlays.
4. Select Targets.
5. Select Show, and turn it on.
6. Select Safe Ring and tap it, or press the ENTER key, to add a check mark to the box.

Chart View with the Safe Ring Displayed

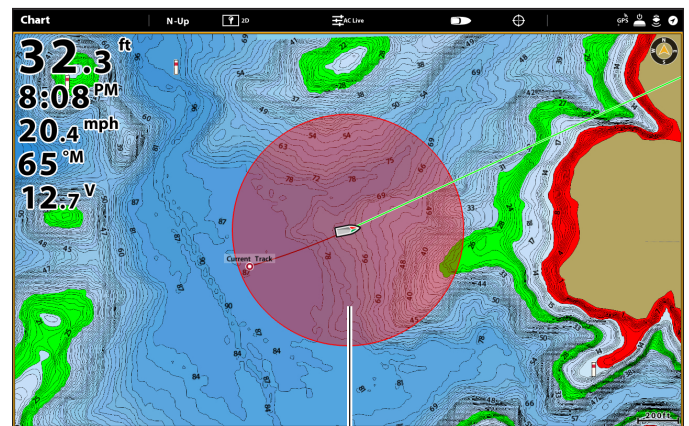

safe zone

Set Target Display Settings

In both AIS and MARPA, when a target is identified, it is displayed on the screen with an icon that indicates the target's safety status. You can set defaults for how the targets will display on the screen.

1. Press the HOME key.
2. Select the Targets tool.
3. Select Settings > Target Settings.

| | |
|---------------------------------|--|
| COG Vector | The COG Vector displays a line extending from the target that indicates the last known ship speed. If you turn on Auto Show, the line is displayed when you select the target with the cursor [see Track AIS Targets]. |
| Sleeping Target [Speed] | Use this menu to set the speed a target must reach for it to be identified as a sleeping target. |
| Rate of Turn | Use this menu to set the turning threshold for the rate of turn icon to be displayed. If the threshold is met, the target's turn icon (port or starboard) will be displayed. |
| Clear Lost Target [Time] | Use this menu to set the amount of time a target will remain on the view after it is identified as a lost target. |

AIS OVERVIEW

When an AIS is connected to the control head network, targets within the AIS VHF transmission range are displayed on the Chart and Radar Views. An AIS and compass/heading sensor are required to enable this feature.

The AIS tracks up to 100 targets at once. The AIS also exchanges information with the targets, including vessel identification, position, course, and speed. When a target exits the AIS transmission range, the information will be cleared automatically.

 **NOTE:** In some cases, vessel data may not be available. The information received from other vessels is determined by the vessel class [Class A = required, Class B = optional], their AIS equipment, and the information the captains choose to transmit.

AIS Broadcast Settings

Your AIS also broadcasts data to vessels within the transmission range. To view your call sign, class, type, position, heading, MMSI [Maritime Mobile Service Identity], and more, open the My AIS Info dialog box.

Open the My AIS Info Dialog Box

1. Press the HOME key.
2. Select Settings.
3. Select My Vessel.
4. Select My AIS Info.

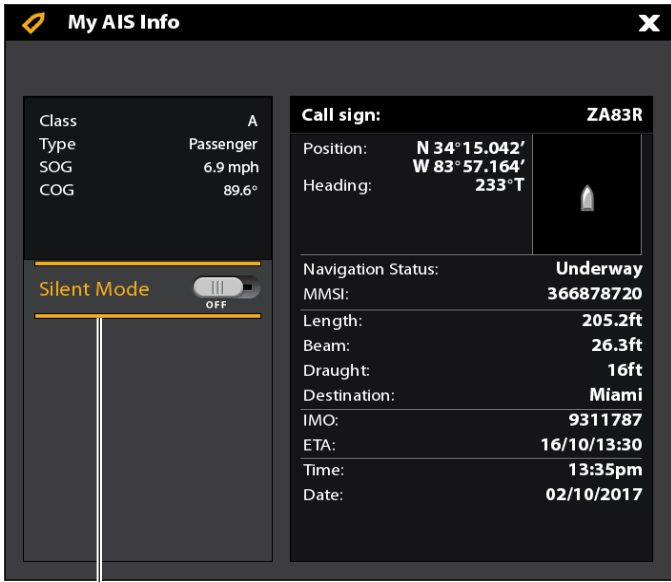

silent mode can be turned on from this dialog box

Turn on/off Silent Mode

If Silent Mode is turned on, your vessel's AIS information will not be broadcast to other vessels. In this case, your AIS is only receiving data from other vessels in the area.

If Silent Mode is turned off, your vessel's AIS information is broadcasted to other vessels, so the AIS is receiving and transmitting.

Silent mode can be turned on or off from the My AIS Info dialog box, or you can use the following instructions.

1. Press the HOME key.
2. Select the Targets tool.
3. Select Settings > Silent Mode. [Default = Off]

 **NOTE:** Silent Mode might not be supported by your AIS equipment. See your AIS installation manual for more information.

AIS Filter Settings

You can also control how many AIS targets are shown on the view by adjusting the filter settings.

Turn on/off Range Filter

If Range Filter is turned on, targets are displayed from your vessel to the distance you set. Targets outside of the range will not be displayed.

If Range Filter is turned off, targets will be displayed within the full range of the AIS equipment's transmission capabilities.

1. Press the HOME key.
2. Select the Targets tool.
3. Select Settings > Range Filter. Tap the on/off button, or press the ENTER key, to turn it on/off.
4. Press and hold the slider, or press and hold the ENTER key, to adjust the setting.

Turn on/off Class B Filter

If Class B Filter is turned on, Class B targets will not be shown. If Class B filter is turned off, all available AIS targets will be shown.

1. Press the HOME key.
2. Select the Targets tool.
3. Select Settings > Class B Filter. Tap the on/off button, or press the ENTER key, to turn it on/off.

AIS Targets

Each target is represented by an icon that indicates the vessel type. The color of the target icon is determined by the AIS Target Type shown on the AIS List. The target type shows its status with the following shapes and additional color details.



For example, the **Cargo Target** appearance will change depending on its status, and whether it is moving or anchored, as shown in the following table:

| Underway Icon | Anchor Icon | Status | Description |
|---------------|-------------|-----------|---|
| | | Dangerous | The target is active and detected as dangerous based on the CPA [Closest Point of Approach] and TCPA [Time to Closest Point of Approach]. The target is outlined in red. |
| | | Uncertain | The target is active, but the calculated CPA [Closest Point of Approach] and TCPA [Time to Closest Point of Approach] have not been received in the last 4 minutes. The target is outlined in white. |
| | | Sleeping | The target is active or inactive, and it is moving slower than the sleeping target threshold. To set the threshold see <i>AIS and MARPA: Set Target Display Settings</i> . |
| | | Inactive | The target is identified and moving, but it is not being tracked by the AIS. |
| | | Active | The target is identified, tracked, moving, and sending data to the AIS. |
| | | Lost | The target is not available for tracking. A target may be lost if its signal has not been received in the last 8 minutes. The target will be grayed out and displayed with its last available position on the view. To adjust the lost threshold, see <i>AIS and MARPA: Set Target Display Settings</i> . |



NOTE: See *Open the AIS Target List* for more information about the AIS List and the AIS Target Key.

Track AIS Targets

You can turn on tracking for all targets. You can also select individual targets and turn tracking on or off.

Turn on/off Automatic AIS Tracking

When Automatic AIS Tracking is turned on, all AIS targets are tracked within the equipment's capabilities.

When Automatic AIS tracking is turned off, all AIS targets are not tracked, but you can still track targets individually [see **Track a Selected Target**].

1. From the Home screen, select the Targets tool.
2. Select Settings > Automatic AIS Tracking. Tap the on/off button, or press the ENTER key.



NOTE: If Automatic AIS Tracking is turned on, but you do not see AIS targets on the Chart and Radar Views, make sure targets are set to display in the Overlays menu. See **Display AIS and MARPA Targets**.

Track a Selected Target

If Automatic AIS Tracking is turned off, you can select a target and track it individually. If Automatic AIS Tracking is turned on, Track Target [for individual target tracking] is not available in the menu system. See **Turn on/off Automatic AIS Tracking** for more information.

1. From the Home screen, select the Targets tool.
2. Under Lists, select AIS.
3. Press and hold a target, or use the Joystick to select it.
4. Select Track Target. Tap the on/off button, or press the ENTER key, to turn it on.

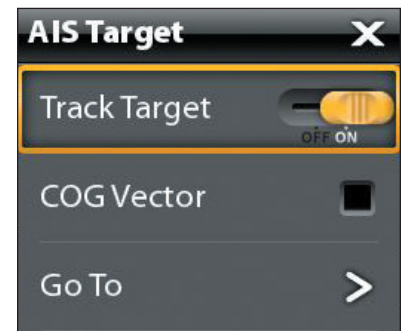

Cancel Tracking for a Selected Target

1. From the Home screen, select the Targets tool.
2. Under Lists, select AIS.
3. Press and hold a target, or use the Joystick to select it.
4. Select Track Target, and turn it off.

Change all Targets to Inactive (X-Press Menu)

Use the instructions in this section to cancel tracking from the X-Press Menu. This menu is available if Automatic AIS Tracking is turned off but individual targets are being tracked [see **Track a Selected Target**].

1. With a Chart View or Radar View displayed on-screen, tap Chart or Radar in the status bar. Select Info.

OR

Press the ENTER key.

2. Select AIS: All Inactive.

Change all Targets to Inactive (Targets Tool)

Use the instructions in this section to cancel tracking from the Targets tool. This menu is available if Automatic AIS Tracking is turned off but individual targets are being tracked [see **Track a Selected Target**].

1. Press the HOME key.
2. Select the Targets tool.
3. Select Cancel All AIS Targets.

Start Navigation to a Selected Target

Start navigation to a selected target using the following instructions. See *Introduction to Navigation* for more features and information.

Start Navigation to a Selected Target

Touch Screen

1. With a Chart View or Radar View displayed on-screen, tap a target to select it.
2. Tap Radar or Chart in the status bar, and select Go To.
3. Select Go To Cursor.

Keypad

1. With a Chart View or Radar View displayed on-screen, use the Joystick to move the cursor to a target.
2. Press the GO TO key.
3. Select Go To Cursor.



NOTE: You can also start navigation from the AIS List in the Targets tool. Select a target and press the MENU key, or press and hold the target name. Select Go To.

Open the AIS Target List

The AIS List is based on the last available transmission calculation and includes the targets' name, MMSI (Maritime Mobile Service Identity, Distance, Bearing, SOG, and Class. The AIS List can be opened in the Targets tool, or it can be opened in the Chart and Radar Views.

Open the AIS List from the Targets Tool

1. Press the HOME key.
2. Select the Targets tool.
3. Under Lists, select AIS.

Open the AIS List from a View

1. With a Chart View or Radar View displayed on-screen, tap Chart or Radar in the status bar. Select Info.

OR

Press the ENTER key.

2. Select AIS List.

AIS Target Data Received

The screenshot displays the AIS List interface. At the top, a title bar reads "AIS Target Data Received". Below it, a table lists several targets. The first target is highlighted, and its details are shown in a summary panel below the table. The summary panel includes fields for Vessel, Position, Heading, Destination, Call sign, Length, ETA, IMO, CPA, Beam, Time, COG, T CPA, Draught, and Date. Below the summary panel is an AIS Target Key with icons for various vessel types and status indicators.

| Name | MMSI | Distance | Brg | SOG | Status | Class |
|-----------------|-----------|----------|-----|-----------|--------|-------|
| MAKING MEMORIES | 265547250 | 0.0 ft | 0°M | 83.1 mph | Lost | A |
| ARCO AVON | 664444000 | 0.0 ft | 0°M | 41.9 mph | Lost | A |
| M/Y "VAMOOSE" | 603916439 | 0.0 ft | 0°M | 90.7 mph | Lost | A |
| MAKING MEMORIES | 538070490 | 0.0 ft | 0°M | 0.0 mph | Lost | A |
| REEF CHIEF | 367116160 | 0.0 ft | 0°M | 19.2 mph | Lost | B |
| STEPHEN DANN | 310525000 | 0.0 ft | 0°M | 117.7 mph | Lost | A |
| TUCHKOV BRIDGE | 369560000 | 0.0 ft | 0°M | 102.7 mph | Lost | A |
| TUCHKOV BRIDGE | 636011644 | 0.0 ft | 0°M | 49.2 mph | Lost | A |

selected target summary

| | | | | | | | |
|------------|-------------------|-----------|--------------|----------|--------|--------------|------------|
| Vessel: | Search and rescue | Position: | N 25°35.833' | Heading: | 41° | Destination: | MIAMI |
| Call sign: | | | W 80°15.500' | Length: | 0.0 ft | ETA: | |
| IMO: | N/A | CPA: | 0.0 ft | Beam: | 0.0 ft | Time: | 2:50:02 PM |
| COG: | 0° | TCPA: | --- | Draught: | 0.0 ft | Date: | 12/19/2012 |

AIS Target Key

| Type | Status |
|------------|-----------|
| Unknown | Dangerous |
| Tug/Pilot | Uncertain |
| Yachts | Sleeping |
| Tankers | Inactive |
| Passenger | Active |
| Fishing | Lost |
| Cargo | Anchor |
| High-Speed | |

Sort the AIS List

1. Press the EXIT key to select the sort bar. Tap a column name, or move the Joystick and press it on a column name. The first tap/Joystick press will sort the column low to high or A to Z. The second tap/Joystick press will sort it high to low or Z to A.

Display the AIS Data for a Selected Target (Targets Tool)

1. From the Home screen, select the Targets tool.
2. Under Lists, select AIS.
3. Tap a target or use the Joystick to select it. Review the summary information in the dialog box [see the illustration *AIS Target Data Received*].

Display the AIS Data for a Selected Target (Chart View or Radar View)

1. With a Chart View or Radar View displayed on-screen, tap a target to select it. Tap the target name.

OR

Use the Joystick to move the cursor to a target. Press the ENTER key.

2. The dialog box will display the target class, type, SOG [Speed over Ground], COG [Course over Ground], CPA [Closest Point of Approach], and TCPA [Time to Closest Point of Approach].

To see all information for the selected target, select Full Info.

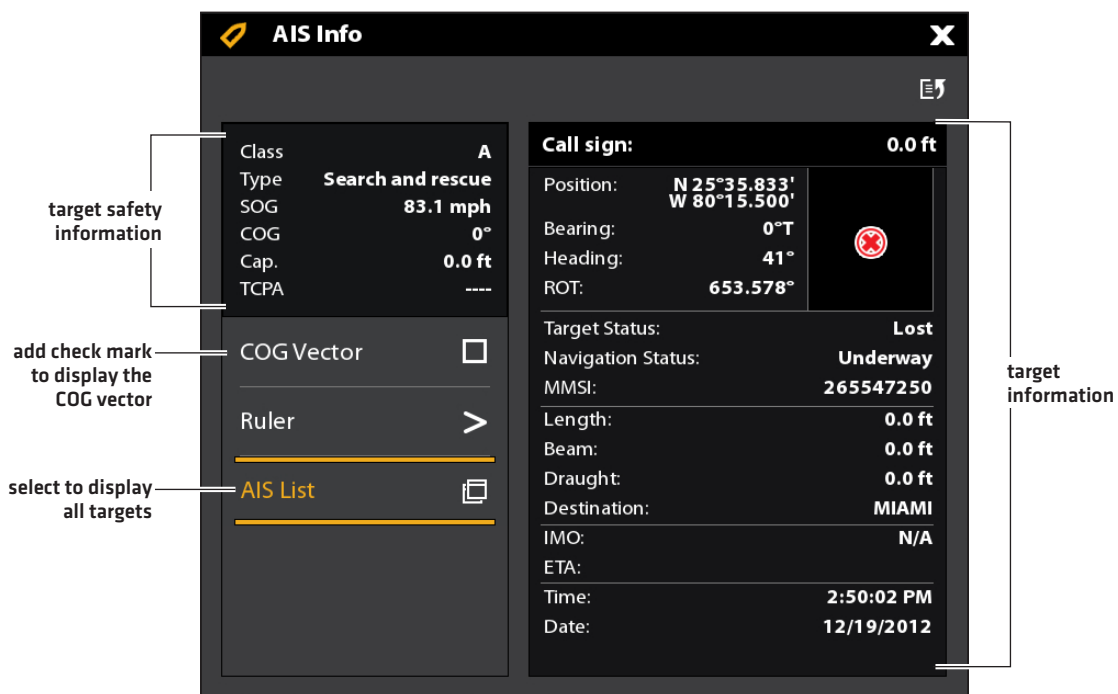

Display the COG Vector for a Selected Target





The COG Vector displays a line extending from the target that indicates the last known ship speed. COG indicates Course over Ground.

1. Select a target from the Targets tool, Radar View, or Chart View.
2. Tap the target name, or press the ENTER key.
3. Select COG Vector.
4. Tap the check box, or press the Joystick, to add a check mark to COG Vector.

MARPA TARGETS

Use MARPA to track targets on the Radar View. A compass/heading sensor must be attached to the control head network to enable MARPA, and the radar must be transmitting [see **Radar Overview**]. If an AIS is connected, then AIS targets will also be displayed on the Radar View. See **AIS and MARPA** for more information.

The control head tracks up to 20 targets at one time. Each target is assigned a number [1 to 20] and an icon to represent its safety status. The possible target status is as follows:

| Icon | Status | Description |
|---|-----------|--|
|  | Acquiring | The control head is processing the target data. The target has been identified but not yet tracked. |
|  | Dangerous | The target is being tracked and has entered the Safe Zone or the Guard Zone. |
|  | Lost | The target is not available for tracking. A target may be lost if it has not been scanned in the last 30 seconds. The target will be displayed with its last available position on the view. |
|  | Safe | The target is being tracked and has not crossed the Safe Zone or Guard Zone. |

Turn on MARPA Tracking

The radar must be transmitting so you can track targets. MARPA targets can be tracked in the Radar View or Chart View.



NOTE: The Radar Transmission Range also influences the number of acquired targets. If the Transmission Range is set too low, you may lose some target information. See **Radar Overview** for more information.

Track a Target

1. Press and hold a radar return. Select Track MARPA to acquire the target.

OR

Use the Joystick to move the cursor to a radar return. Press the Joystick to acquire the target.

Radar View with MARPA Targets Displayed

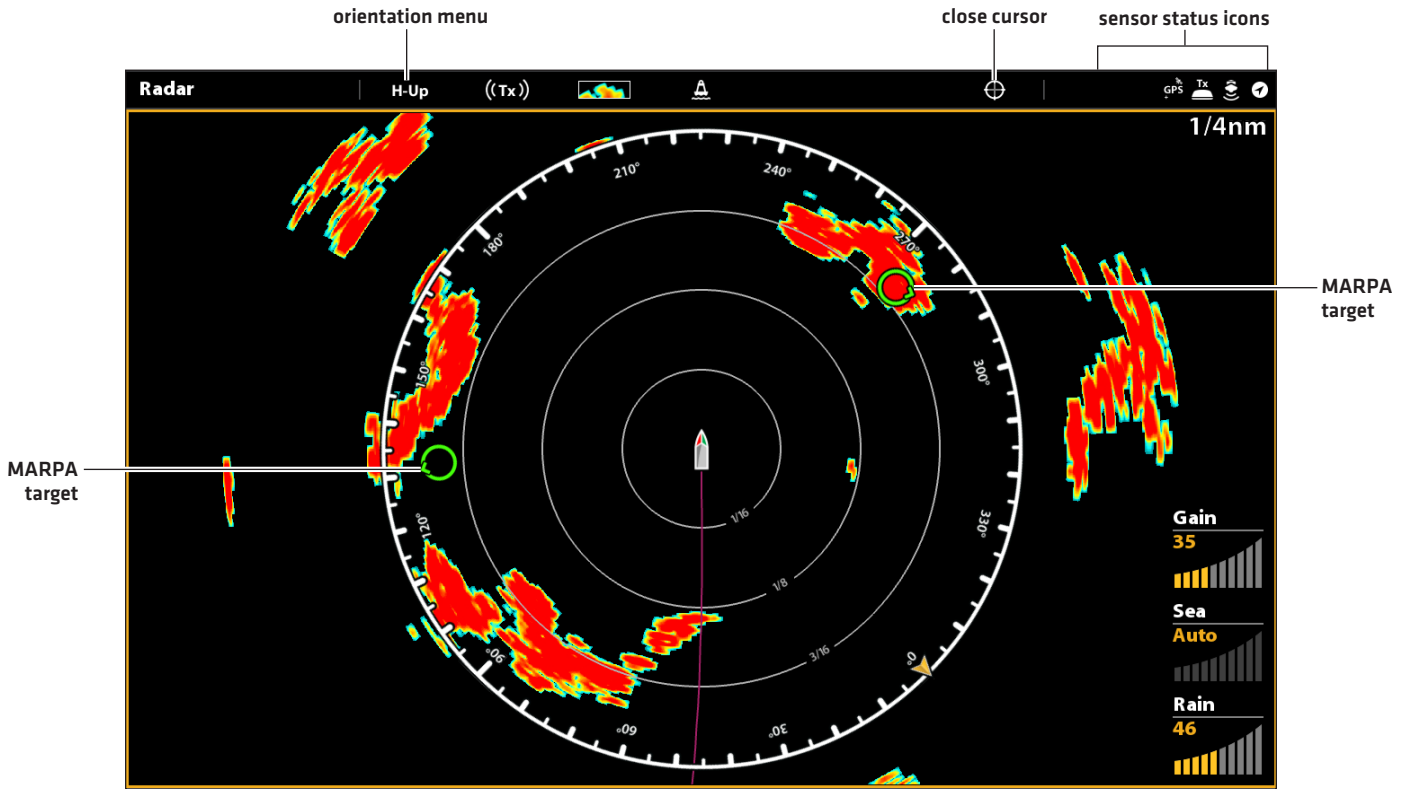

Press and Hold
a Radar Return

OR

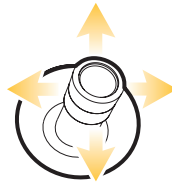

Move the Cursor to
a Radar Return

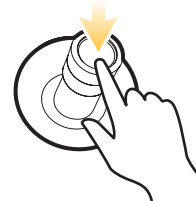

Press the Joystick
to Acquire Target

Cancel Tracking for a Selected Target

1. Select a target from the Radar View, Chart View, or Targets tool.
2. Tap the target name, or press the ENTER key.
3. Select Cancel Target.

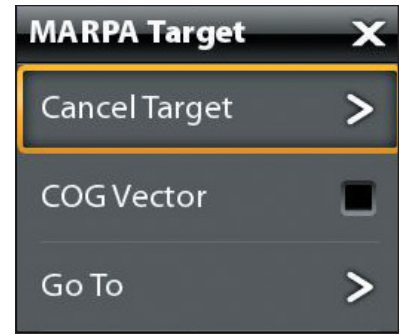

Cancel Tracking for all Targets (X-Press Menu)

Use the instructions in this section to cancel tracking from the X-Press Menu.

1. With a Chart View or Radar View displayed on-screen, tap Chart or Radar in the status bar. Select Info.

OR

Press the ENTER key.

2. Select MARPA: All Inactive.

Cancel Tracking for all Targets (Targets Tool)

Use the instructions in this section to cancel tracking from the Targets tool.

1. Press the HOME key.
2. Select the Targets tool.
3. Select Cancel All MARPA Targets.

Start Navigation to a Selected Target

Start navigation to a selected target using the following instructions. See *Introduction to Navigation* for more features and information.

Start Navigation to a Selected Target

Touch Screen

1. With a Chart View or Radar View displayed on-screen, tap a target to select it.
2. Tap Radar or Chart in the status bar, and select Go To.
3. Select Go To Cursor.

Keypad

1. With a Chart View or Radar View displayed on-screen, use the Joystick to move the cursor to a target.
2. Press the GO TO key.
3. Select Go To Cursor.



NOTE: You can also start navigation from the MARPA List in the Targets tool. Select a target and press the MENU key, or press and hold the target name. Select Go To.

Open the MARPA Target List

Open the MARPA List from the Targets Tool

1. Press the HOME key.
2. Select the Targets tool.
3. Under Lists, select MARPA.

Open the MARPA List from a View

1. With a Chart View or Radar View displayed on-screen, tap Chart or Radar in the status bar. Select Info.
OR
Press the ENTER key.
2. Select MARPA List.

MARPA Targets Data Received

The screenshot shows the MARPA List interface. At the top, it says "MARPA List" and "Total Tracked 2". Below this is a table with the following columns: ID, Distance, CPA, TCPA, Brg, COG, SOG, and Status. The first target (ID 1) is highlighted with a red circle and labeled "selected target". The second target (ID 2) is labeled "target list". To the right of the table, there is a "sort list by columns" label. Below the table is a "MARPA Target Key" section with four icons: Acquiring (yellow), Dangerous (red), Lost (grey), and Safe (green). On the right side of the screen, there are radar settings: Gain 35, Sea Auto, and Rain 46. The background shows a radar display with a scale of 1/4nm.

| ID | Distance | CPA | TCPA | Brg | COG | SOG | Status |
|----|----------|----------|-------|-------|--------|---------|-----------|
| 1 | 412.6 ft | 145.9 ft | 5 min | 51°T | 314.9° | 0.4 mph | Dangerous |
| 2 | 441.8 ft | 441.8 ft | --- | 257°T | 180° | 0.0 mph | Lost |

MARPA Target Key

Acquiring Dangerous Lost Safe

Sort the MARPA List

1. Press the EXIT key to select the sort bar. Tap a column name, or move the Joystick and press it on a column name. The first tap/Joystick press will sort the column low to high or A to Z. The second tap/Joystick press will sort it high to low or Z to A.

Display the MARPA Data for a Selected Target

1. With a Chart View or Radar View displayed on-screen, tap the target. Tap the target name.

OR

Use the Joystick to select a target. Press the ENTER key.

2. The dialog box will display the ID, SOG [Speed over Ground], COG [Course over Ground], CPA [Closest Point of Approach], and TCPA [Time to Closest Point of Approach].

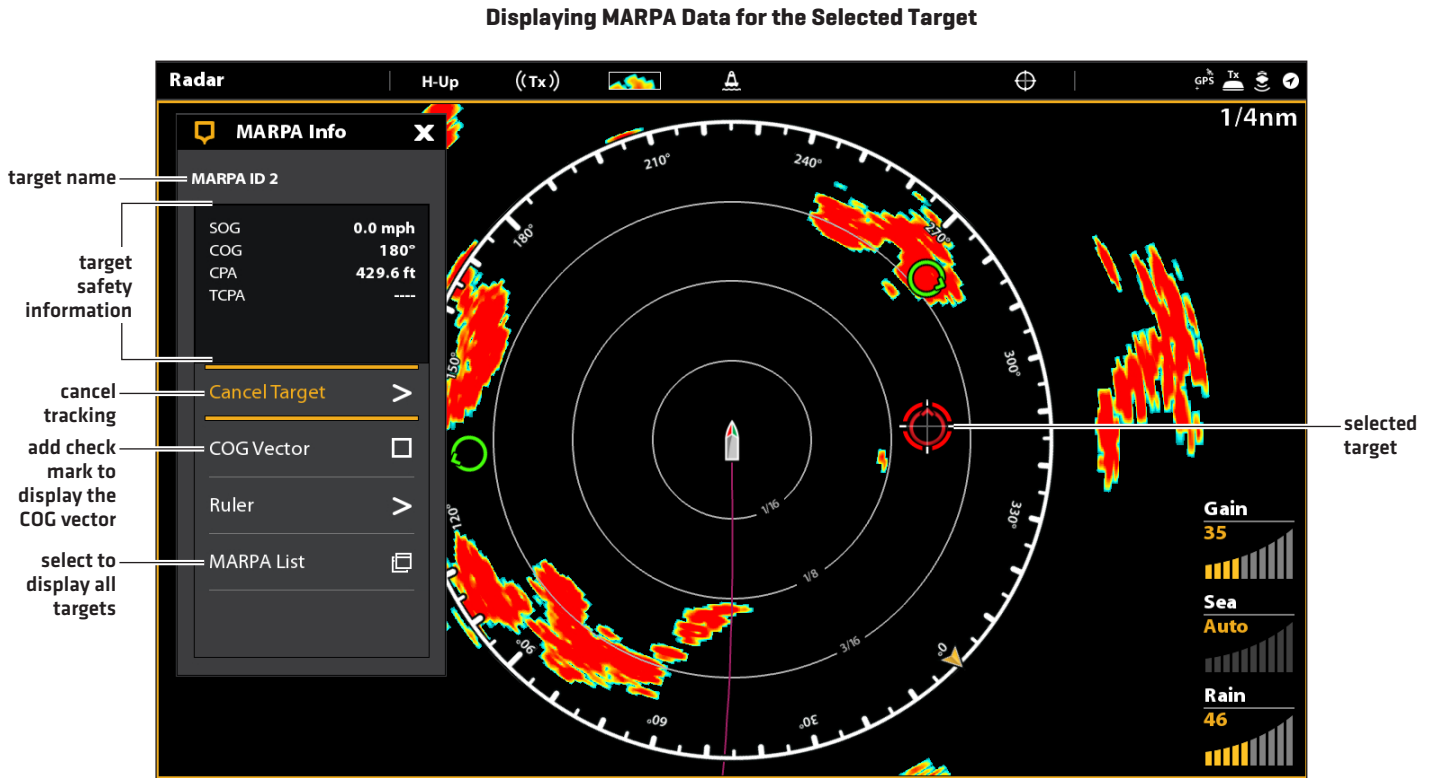

Display the COG Vector for a Selected Target

The COG Vector displays a line extending from the target that indicates the Course over Ground.

1. Select a target from the Radar View, Chart View, or Targets tool.
2. Tap the target name, or press the ENTER key.
3. Select COG Vector.
4. Tap the check box, or use the Joystick, to add a check mark to COG Vector.

SONAR OVERVIEW

A functioning transducer must be attached to the control head or selected as the transducer source on the Ethernet network to enable sonar functions. To purchase transducers and black box sonar equipment, visit our Web site at humminbird.com.

The APEX and SOLIX control heads support the following sonar:

- **MEGA Imaging+ with Dual Spectrum CHIRP Sonar**
- **MEGA Imaging with Dual Spectrum CHIRP Sonar**
- **Dual Spectrum CHIRP Sonar (2D)**
- **Digital CHIRP Sonar:** Side Imaging CHIRP and Down Imaging CHIRP allow you to use multiple frequency ranges, either individually or blended together.
- **Analog Sonar:** Traditional 2D, DualBeam PLUS, Side Imaging, and Down Imaging use single frequency ranges. To use single frequency sonar, turn CHIRP off. See *Installation Information: Set up or Change Transducer Settings*.



NOTE: Depth capability is affected by such factors as boat speed, wave action, bottom hardness, water conditions, and transducer installation. See the *Specifications* section for details.

MEGA Imaging+

MEGA Side Imaging+ and MEGA Down Imaging+ sonar provides three high frequency options, and includes [2D] Dual Spectrum CHIRP sonar.

MEGA Imaging+ transducers

MEGA SI+

XM 14 HW MSI T
 XTM 14 HW MSI T
 XPTH 14 HW MSI T
 M 14 HW MDI T
 XTM 14 HW MDI T
 SSTH 14 HW MSI T

MEGA DI+

XM 14 HW MDI T
 XTM 14 HW MDI T

MEGA SI+

MSI+ sonar uses two very precise sonar beams that are aimed at right angles to the path of the boat. The side beam coverage is very thin from front to back, yet very wide from top to bottom. The beams provide thin slices of the bottom for high resolution imaging. The beams can be operated at one of three display frequencies: MEGA+, 800 kHz, or 455 kHz.

MSI+ sonar also provides MEGA Down Imaging+ and [2D] Dual Spectrum CHIRP sonar.

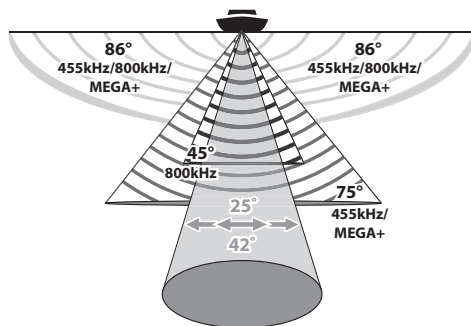

MEGA+

Select MEGA for the highest resolution, sharpness, and range (up to 500 ft side to side).

800 kHz

Select 800 kHz as an alternative frequency with sharp returns (up to 250 ft side to side).

455 kHz

Select 455 kHz for deep water and overall coverage (up to 800 ft side to side).

MEGA DI+

MDI+ sonar beams point down and scan the water with razor-thin, high definition beams that are wide side to side, but very thin from front to back. The beams can be operated at one of three display frequencies: MEGA+, 800 kHz, or 455 kHz.

MDI+ also includes [2D] Dual Spectrum CHIRP sonar.

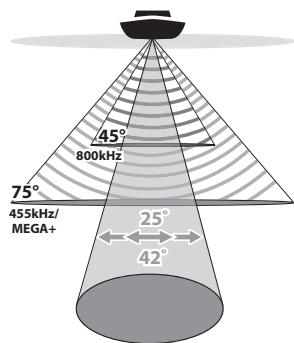

MEGA DI+ Cone Angles

MEGA+

Select MEGA for the highest resolution, sharpness, and depth (up to 250 ft).

800 kHz

Select 800 kHz as an alternative frequency with sharp returns (up to 125 ft).

455 kHz

Select 455 kHz for deep water and overall coverage (up to 400 ft).

(2D) Dual Spectrum CHIRP

Dual Spectrum CHIRP sonar provides conical coverage directly below the boat. The beam can be adjusted to show the full, narrow, or wide frequency range. The sonar returns are displayed on the Sonar [2D] Views.

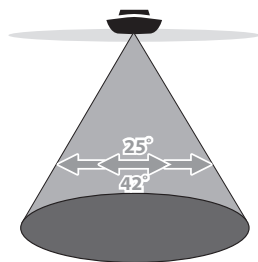

Dual Spectrum Cone Angles

Full

Select Full Beam (default) to use the complete frequency range.

Narrow

Select Narrow Beam for increased bottom detail and better target separation.

Wide

Select Wide Beam to maximize coverage and show big, clearly defined fish arches.

MEGA Imaging

MEGA Side Imaging and MEGA Down Imaging transducers provide high frequency options, and includes either [2D] Dual Spectrum CHIRP sonar or [2D] DualBeam PLUS sonar [see each table below for respective transducer models].

MEGA Down Imaging Transducers with (2D) Dual Spectrum CHIRP

XM 14 20 MDI T
XTM 14 20 MDI T

MEGA Imaging Transducers with (2D) DualBeam PLUS

MEGA SI

XM 14 20 MSI T
XPTH 14 74 MSI T
XTM 14 20 MSI T

MEGA DI

XM 14 MDI T
XTM 14 20 MDI T

MEGA SI

MSI sonar uses two very precise sonar beams that are aimed at right angles to the path of the boat. The side beam coverage is very thin from front to back, yet very wide from top to bottom. The beams provide thin slices of the bottom for high resolution imaging. The beams can be operated at one of three display frequencies: MEGA, 800 kHz, or 455 kHz.

MSI sonar also provides MEGA Down Imaging and (2D) DualBeam PLUS sonar.

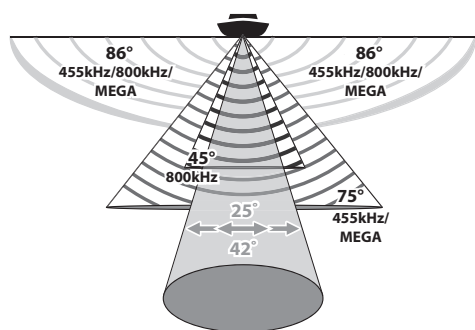

MEGA SI Cone Angles

MEGA

Select MEGA for the highest resolution, sharpness, and range (up to 250 ft side to side).

800 kHz

Select 800 kHz as an alternative frequency with sharp returns (up to 250 ft side to side).

455 kHz

Select 455 kHz for deep water and overall coverage (up to 800 ft side to side).

MEGA DI

MDI sonar beams point down and scan the water with razor-thin, high definition beams that are wide side to side, but very thin from front to back. The beams can be operated at MEGA, 800 kHz, or 455 kHz.

MDI sonar also provides (2D) Dual Spectrum CHIRP sonar.

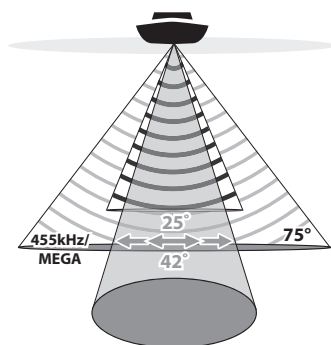

MEGA DI Cone Angles

MEGA

Select MEGA for the highest resolution, sharpness, and depth (up to 125 ft).

*For MEGA SI models, the depth is up to 75 ft.

800 kHz

Select 800 kHz as an alternative frequency with sharp returns (up to 125 ft).

455 kHz

Select 455 kHz for deep water and overall coverage (up to 350 ft).

(2D) Dual Spectrum CHIRP

Dual Spectrum CHIRP sonar provides conical coverage directly below the boat. The beam can be adjusted to show the full, narrow, or wide frequency range. The sonar returns are displayed on the Sonar [2D] Views.

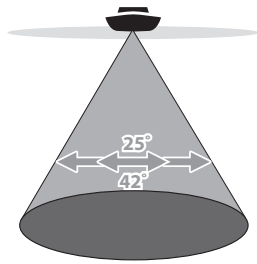

Dual Spectrum Cone Angles

| | |
|---------------|--|
| Full | Select Full Beam [default] to use the complete frequency range. |
| Narrow | Select Narrow Beam for increased bottom detail and better target separation. |
| Wide | Select Wide Beam to maximize coverage and show big, clearly defined fish arches. |

Dual Spectrum CHIRP

Transducers with HW Dual Spectrum CHIRP

| Transducers with HW Dual Spectrum CHIRP | | | |
|---|---|--|--|
| MEGA SI+ XM 14 HW MSI T XTM 14 HW MSI T XPTH 14 HW MSI T XPTH 14 HW T XP 14 HW XP 14 HW T XTM 14 HW T | MEGA DI XM 14 20 MDI T XTM 14 20 MDI T | MEGA SI+ XM 14 HW MSI T XTM 14 HW MSI T XPTH 14 HW MSI T | (2D) Dual Spectrum CHIRP XNT 14 HW T |

Traditional (2D) 83/200 kHz Sonar

DualBeam PLUS sonar provides conical coverage directly below the boat. DualBeam PLUS sonar returns are displayed in Sonar [2D] Views. The beams can be blended together, viewed separately, or compared side-to-side.

83/200 kHz Transducers

| 83/200 kHz Transducers | |
|---|--|
| 2D Sonar XNT 14 20 T XP 14 20 T XP 14 20 XTM 14 20 T XPTH 14 20 T | DI and SI XM 14 20 HDSI T XTM 14 20 HDSI T XPTH 14 20 HDSI T |

DualBeam PLUS Sonar

DualBeam PLUS sonar provides conical coverage directly below the boat. The beam can be adjusted to show the medium, high, or medium-high frequency range. DualBeam PLUS sonar returns are displayed on the Sonar [2D] Views.

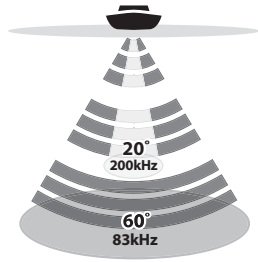

DualBeam Cone Angles

**Medium
[83 kHz]
Frequency**

Select Medium Frequency for deep water (more than 800 feet). Medium Frequency can be used for deep returns at high speed. If Medium Frequency is selected, the high frequency beam pings in the background but is not displayed.

**High
[200 kHz]
Frequency**

Select High Frequency for more detail at shallower depths (less than 800 feet). If High Frequency is selected, the medium frequency beam is not available.

**Medium/
High
[83/200 kHz]
Frequency**

Select Medium/High Frequency to ensure both beams ping continuously, so the sonar history is not interrupted if the Sonar View is closed.

The returns from both beams are blended by starting with the wide beam return, dimming it, and then overlaying it with the narrow beam return. The narrow beam sonar returns will stand out from the wide beam sonar returns.

Digital 50/200 kHz CHIRP Sonar

50/200 kHz Transducers

2D Models

XNT 14 74 T
74 HDSI T
XPTH 14 74 HDSI T

DI and SI Models

XM 14 74 MSI T
XPTH 14 74 MSI T
XT 14

2D Display

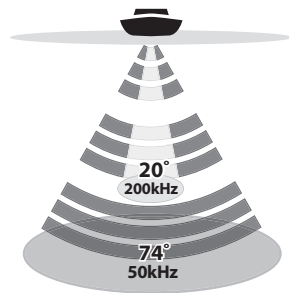

50/200 kHz Cone Angle

**50 kHz
[Low]**

Select 50 kHz for deep water (more than 1500 feet). 50 kHz can be used for deep returns at high speed. If 50 kHz is selected, the 200 kHz beam pings in the background but is not displayed.

**200 kHz
[High]**

Select 200 kHz for faster pinging and shallower water (less than 800 feet).

SONAR SETUP

The available sonar views and menus on the control head are determined by the connected transducer and the selected transducer source. The selected transducer must be pinging to enable the views.

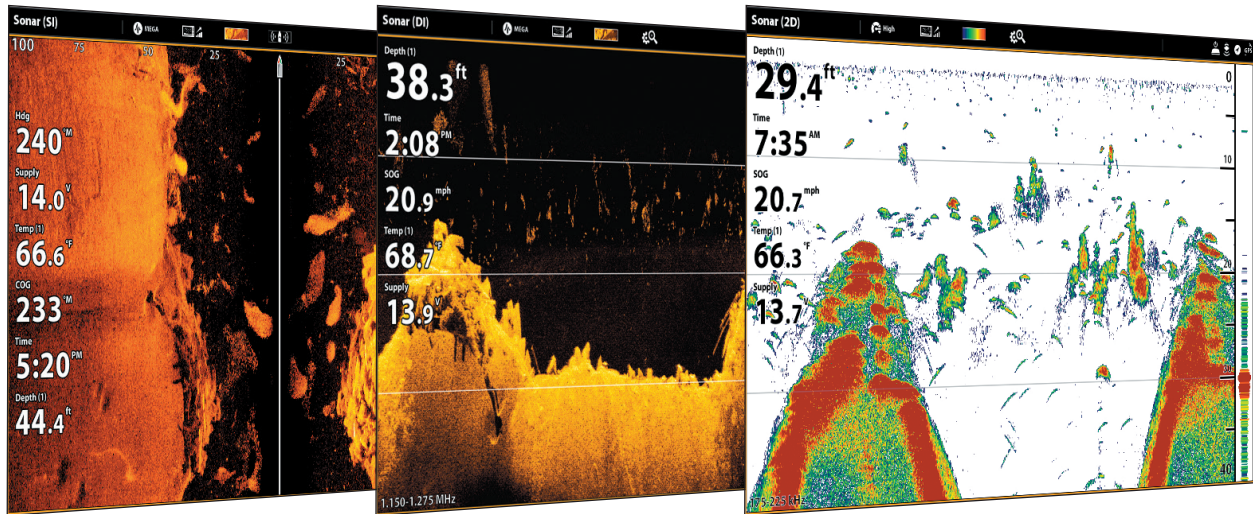

When you connect a transducer to a black box sonar or to the APEX or SOLIX control head, the transducer will be detected in the network automatically. The best sonar source will be chosen and start pinging automatically.

To manually select a sonar source, see *Installation Information: Set up your Humminbird Network*.

Transducer Settings: To review transducer settings, including sonar frequencies, depth offset, and maximum depth, see *Installation Information: Set up or Change Transducer Settings*. Also, visit our Web site at humminbird.com to download the Transducer Setup Guide and review troubleshooting options.

Sonar Settings: You can also change the water type, adjust the noise filter, and select transducer beams. The main sonar settings are displayed in the Sonar tab in the Settings tool [Home > Settings > Sonar]. If an accessory transducer is added to the configuration [such as a 360 Imaging transducer or an Airmar CHIRP transducer], the related menu options will be added to the menu system. See *Installation Information: Set up or Change Transducer Settings*.



NOTE: Visit our Web site at humminbird.com for the latest compatible transducers and accessories for your control head.

SONAR ALARMS

Before you start navigating and fishing with your control head, set up sonar alarms. A functioning transducer must be attached to the control head or selected as the transducer source on the network to enable all sonar functions.

Turn on Sonar Alarms

1. Press the HOME key.
2. Select Alarms.
3. Select Alarms > Sonar.
4. Select an alarm and turn it on. Tap the on/off button, or press the ENTER key, to turn it on.
5. Press and hold the slider, or press and hold the ENTER key, to adjust the range setting.

| | |
|-----------------------|--|
| Fish [Shallow] | Turn on Fish [Shallow] to receive an alarm if fish are detected in shallow water. You can also adjust the shallow water range with the slider. |
| Fish [Deep] | Turn on Fish [Deep] to receive an alarm if fish are detected in deep water. You can also adjust the deep water range with the slider. |
| Shallow Water | If the bottom depth is less than the amount you set, the control head will provide an alarm. |
| Deep Water | If the bottom depth is more than the amount you set, the control head will provide an alarm. |

2D SONAR OVERVIEW

As the boat moves, the unit charts the changes in depth on the display to create a profile of the bottom contour. The 2D Sonar View displays the sonar return intensity with different colors.

Strong returns often result from rocky or hard bottoms [compacted sediment, rocks, fallen trees], while weaker returns often result from soft bottoms [sand, mud], vegetation, and small fish.

The colors used to represent high, medium, to low intensity returns are determined by the palette you choose in the Preferences menu [see *Open the 2D Sonar Preferences Menu: Change the Palette and Background*].

The control head displays the return intensity based on the Palette and Bottom View menu settings. You can display the RTS Window [Real Time Sonar], turn on/off fish symbols [Fish ID+], change the SwitchFire mode, adjust sensitivity, and more.

2D Sonar View: Original Palette

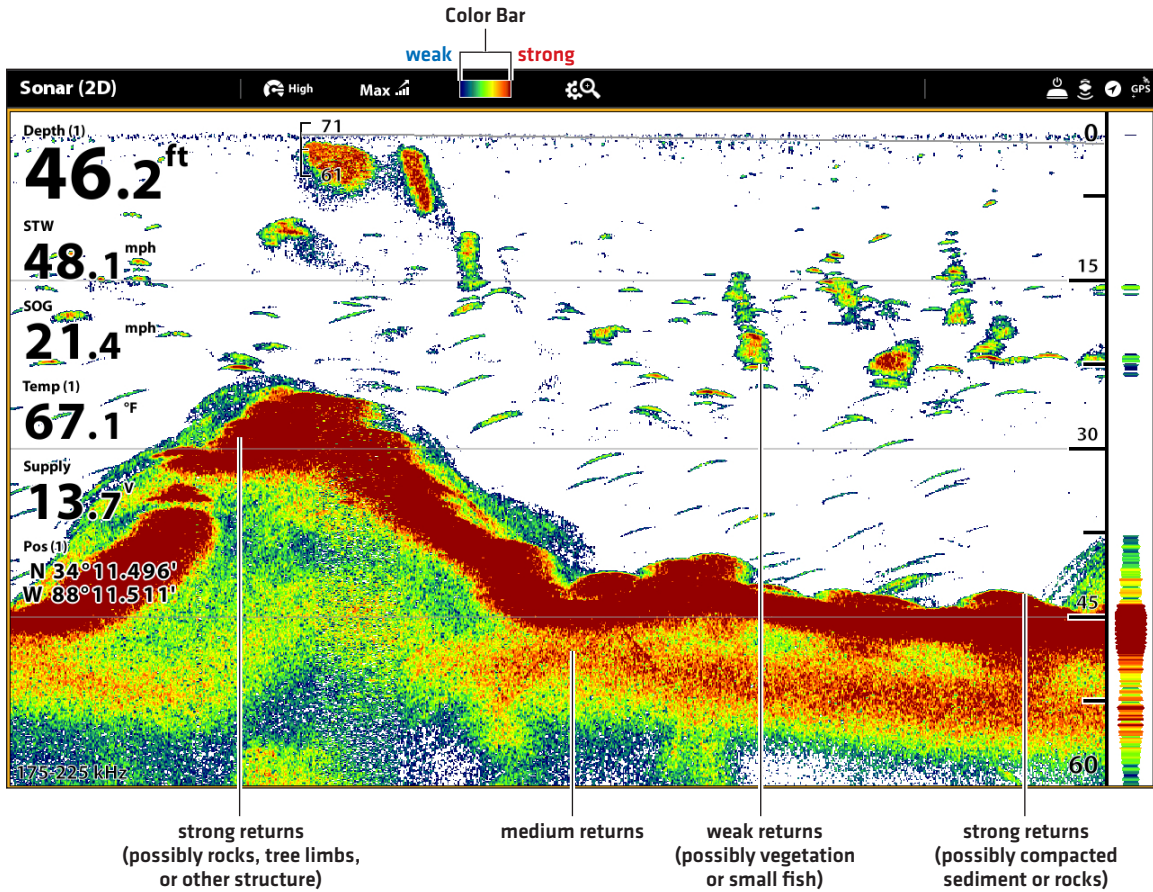

strong returns
(possibly rocks, tree limbs,
or other structure)

medium returns

weak returns
(possibly vegetation
or small fish)

strong returns
(possibly compacted
sediment or rocks)

Sonar History – Historical returns scroll left across the view.



Drag to see History

OR

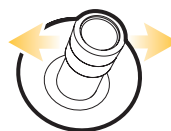

Move to see History

CUSTOMIZE THE 2D SONAR VIEW

The settings in this section are optional. You can use the default settings for the 2D Sonar View, or you can customize it with your preferences. See **Views** for more information.

OPEN THE 2D SONAR PREFERENCES MENU

The Preferences menu allows you to set the sonar mode, zoom mode, return palette, background color, bottom view, and RTS Window. For more information about view preferences, see **Views**.

1. With a 2D Sonar View displayed on-screen, tap Sonar [2D] in the status bar, or press the MENU key once.
2. Select Sonar Options.
3. Select Preferences.

Change the Sonar Mode

The 2D Sonar data can be displayed on the full screen. You can also choose a split screen to display the beams separately, or you can display a split zoom view.

1. From the Preferences menu, select Sonar Mode.
2. Select a mode to apply to the view.

Split (Dual) Sonar Mode

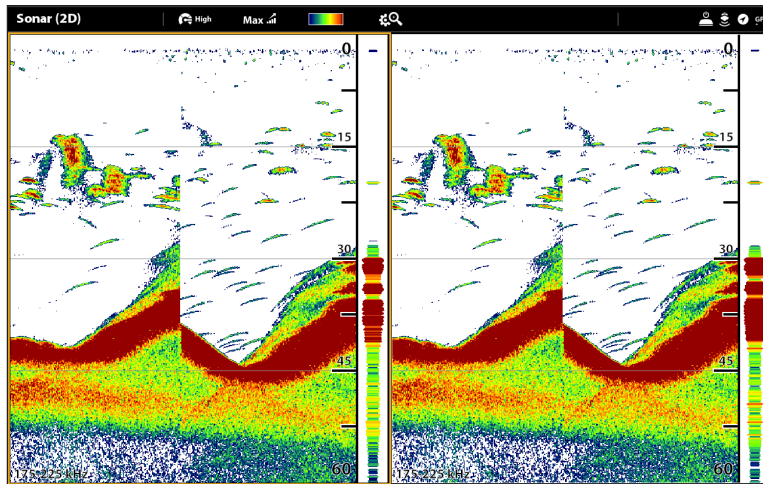

| | |
|---------------------|--|
| Normal | The 2D Sonar is displayed on the full screen. |
| Split [Zoom] | The view is split into two sides. 2D Sonar View is displayed on the right side with a zoom preview box. The zoomed view is shown on the left side. Select Split [Zoom] from the Preferences menu, and you can turn on Flat Bottom and change the Zoom Window size. |
| Split [Dual] | The view displays sonar returns from each down beam frequency on separate sides of the screen. You can use the split mode to make side by side comparisons between the sonar returns from both beams. |

Set the Zoom Mode

The Zoom Mode sets the zoom commands to magnify the full pane or the cursor selection. See *Use Cursor and Zoom in Sonar Views* to apply the zoom features.

1. From the Preferences menu, select Zoom Mode.
2. Select Pane Zoom or Cursor Zoom.

| | |
|-------------|---|
| Pane Zoom | When you use pinch out/in [touch screen] to zoom, or press the +/- ZOOM keys, the view will be magnified. |
| Cursor Zoom | When you use pinch out/in [touch screen] to zoom, or press the +/- ZOOM keys, the cursor selection will be magnified. |

Change the Color Palette

The Sonar Colors menu changes the colors used to display sonar returns on the view.

1. From the Preferences menu, select Sonar Colors.
2. Select a color palette.



QUICK TIP! This setting can also be changed in the status bar menu

Sonar View with a Customized Palette and Background

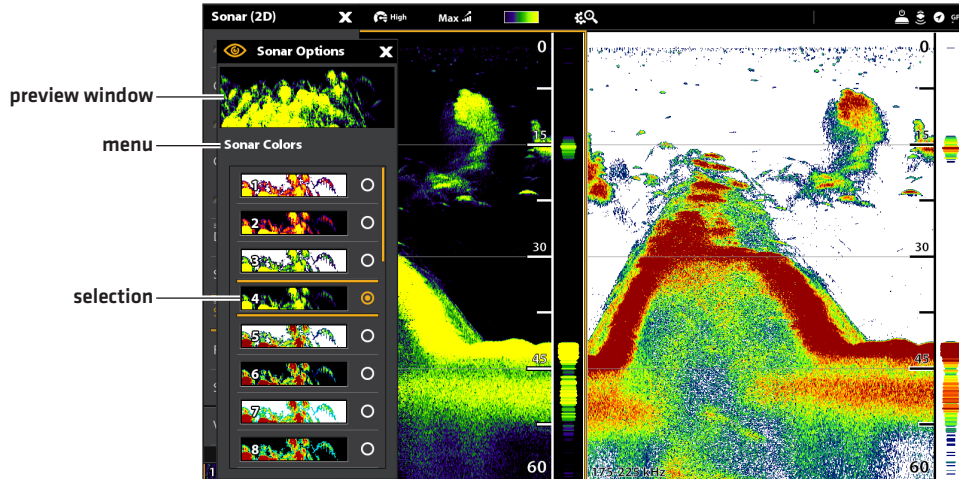

Palette Options

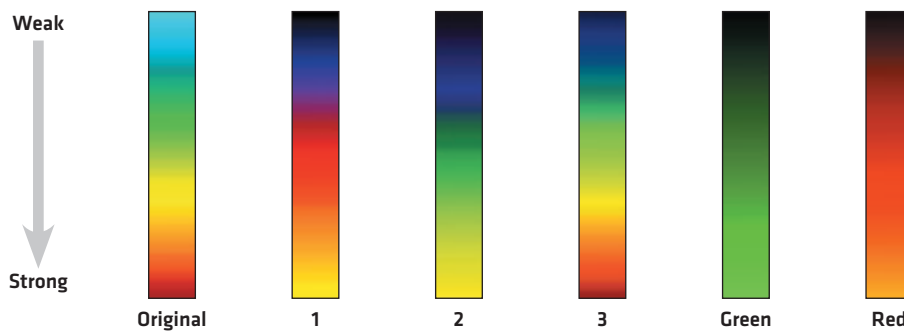

Set the Bottom View Preferences

Bottom View selects the method used to represent bottom and structure on the display. There are many ways to display the bottom on the display.

1. From the Preferences menu, select Bottom View.
2. Select Structure ID or White Line. Then, select Bottom Fill and/or Bottom Line to add them to the view.

2D View with Bottom View Options Displayed

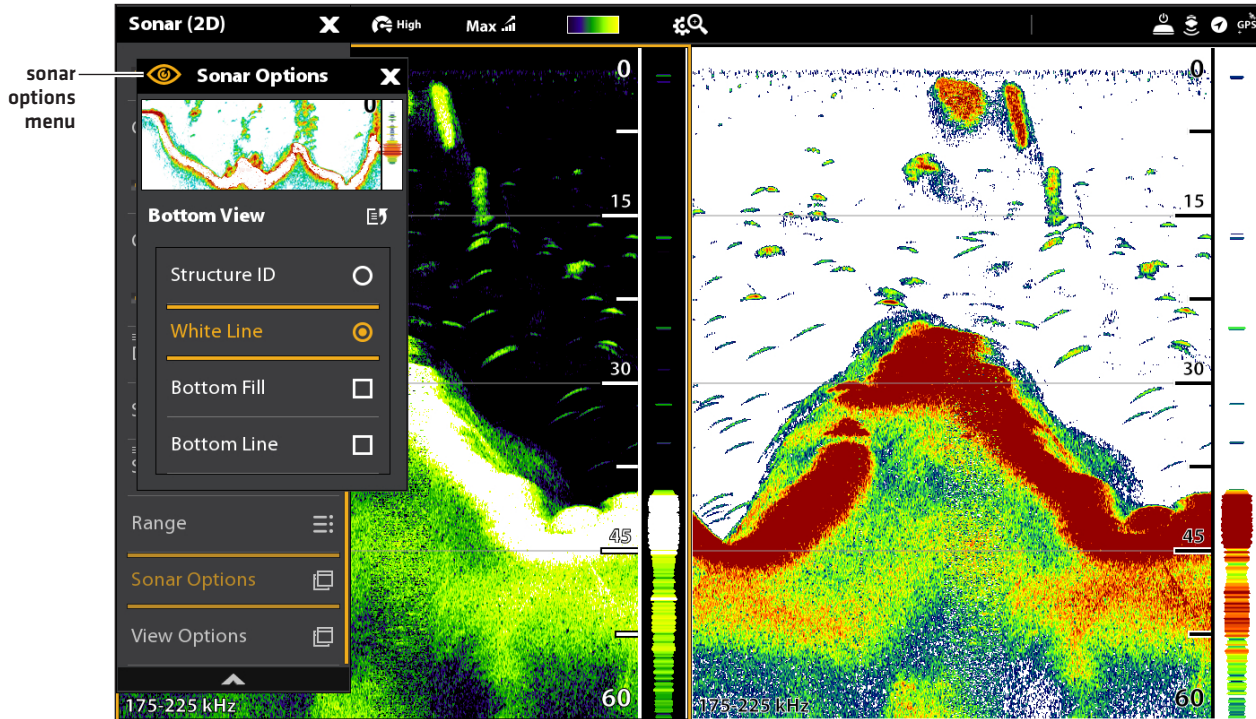

| | |
|--------------|--|
| Structure ID | Structure ID represents weak returns in blue and strong returns in red [original palette]. If the Palette is changed, the Structure ID will display the strongest return as specified by the palette. |
| White Line | White Line highlights the strongest sonar returns in white. This has the benefit of clearly defining the bottom on the display. |
| Bottom Fill | Select Bottom Fill to see the shaded bottom filled in with a solid color on the view. This has the benefit of clearly defining the bottom location on the display. |
| Bottom Line | Select Bottom Line to display the depth reading from the Depth Source as a line, either from the selected transducer or another digital depth source. See Set up your Humminbird Network for details about selecting sources. |

Display the RTS Window

The RTS Window plots the depth and intensity of a sonar return. It updates at the fastest rate possible for depth conditions and shows only the returns from the bottom, structure, and fish that are within the transducer beam. When you use the cursor to review sonar history, the sonar history will pause, but the RTS Window will continue to display sonar returns in real time.

1. From the Preferences menu, select RTS Window.
2. Tap the on/off button, or press the ENTER key, to turn it on. Then, choose the type of RTS Window to display.

| | |
|------------------------|---|
| Color [A-Scope] | Sonar returns are displayed in color. The size of the displayed lines correspond with the intensity of the sonar returns from the transducer beam[s]. |
| Color [Full] | Sonar returns are displayed in color, and they fill the width of the RTS Window. |
| Mono | Sonar returns are displayed in black. |

Turn on/off Fish ID+

Fish ID+ uses advanced signal processing to interpret sonar returns. When Fish ID+ is selected, fish symbols will be displayed on the Sonar View when very selective requirements are met.

When Fish ID+ is not selected, the control head shows only the raw sonar returns on the display. The returns appear as arches on the display to indicate potential targets.

1. From the Preferences menu, select Fish ID+.
2. Use the following menu options to display fish icons, adjust the sensitivity, and more.

| | |
|-----------------------|--|
| Fish Icons | Select Fish Icons to display fish symbols on the 2D Sonar View when a fish is detected. Blue Fish Icons = targets detected in the 200 kHz narrow beam. Orange Fish Icons = targets detected in the 83 kHz or 50 kHz wide beam. |
| Fish Depth | The depth of the fish is displayed above the fish icon. |
| ID Sensitivity | Use ID Sensitivity to adjust the threshold used for detecting a fish with Fish ID+. (1 = low sensitivity, where only a large fish will be displayed, and 10 = high sensitivity, where small fish up to large fish will be displayed) |
| Fish Alerts | To receive an on-screen alert when a fish is detected, turn on this menu option. |

2D Sonar View (Split Dual Mode) with RTS Window and Fish ID+ Turned On

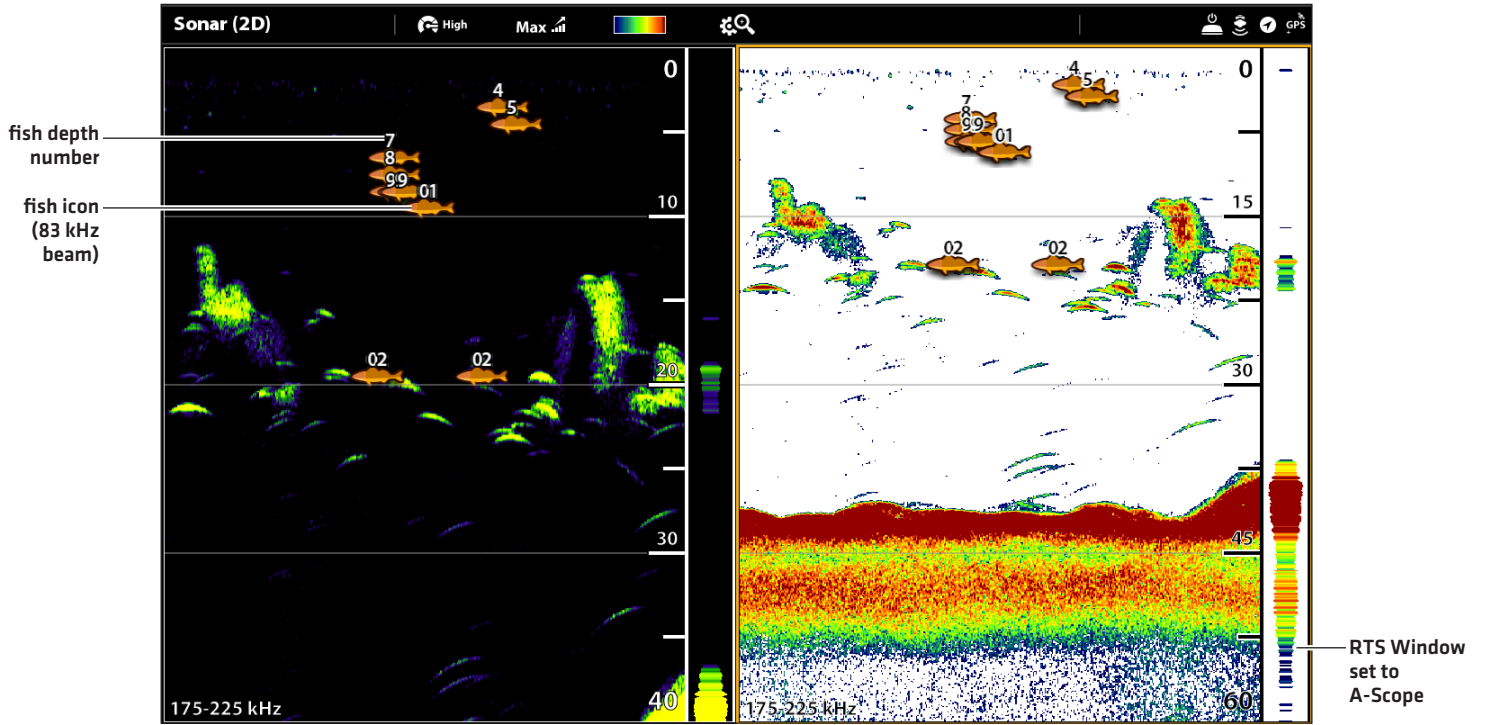

CHANGE THE 2D SONAR VIEW OVERLAYS

Use the Overlays menu to display or hide information on the view. In the 2D Sonar View, you can display the following: depth lines, depth range, a color bar for the selected palette, temperature graph, beam frequency label, and data overlays.

Digital readout data can be displayed as an overlay, and it can be displayed in the data bar. To turn on the data overlay or data bar, see **Views: Edit the On-Screen View**. For more information about data overlays, see **Views**.

1. With a 2D Sonar View displayed on-screen, tap Sonar [2D] in the status bar, or press the MENU key once.
2. Select Sonar Options.
3. Select Overlays.
4. Tap the menu, or use the Joystick to select an item, and add a check mark. [check mark = visible, blank = hidden].

Selecting Overlays for the 2D Sonar View

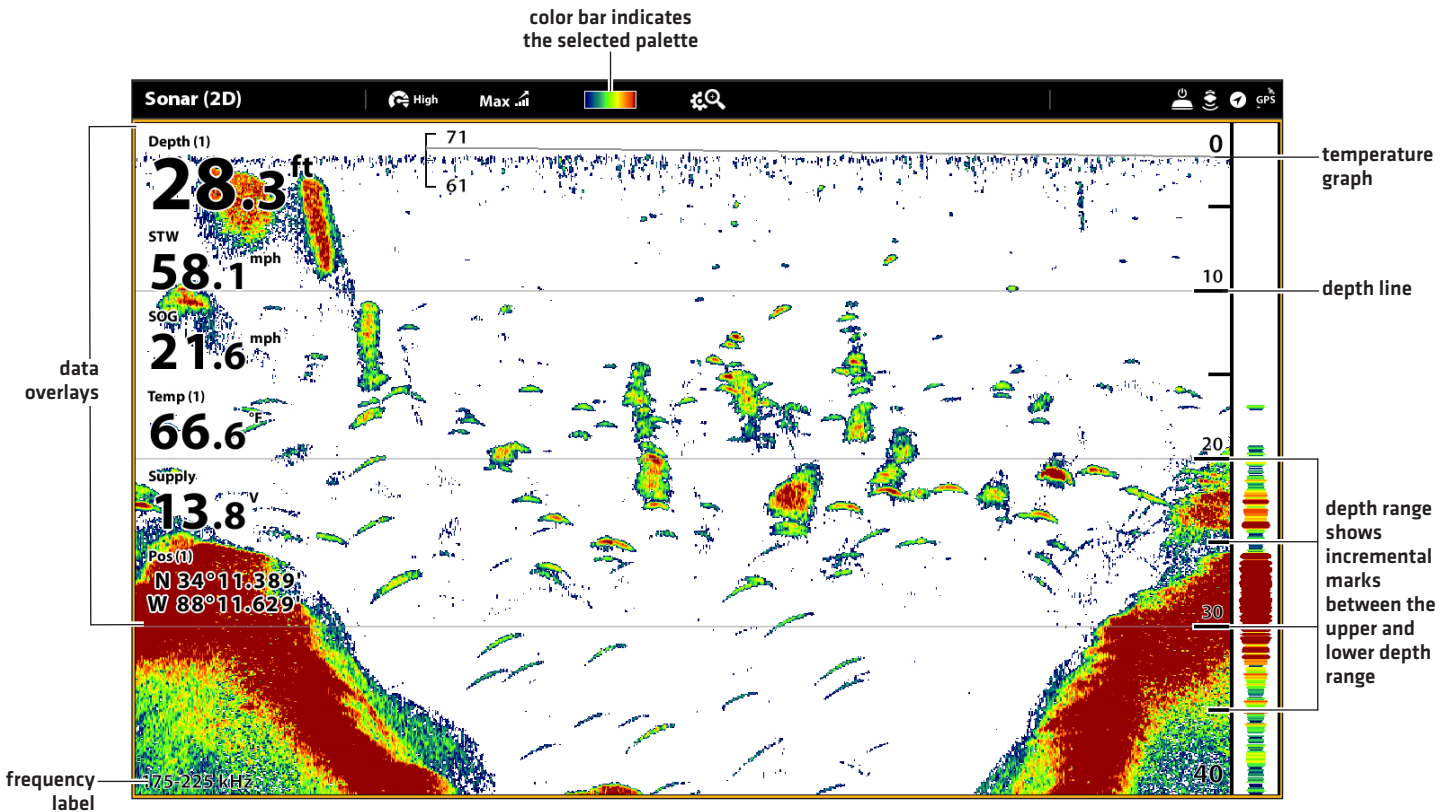

ADJUST 2D SONAR DISPLAY SETTINGS

The X-Press Menu provides menu options to adjust the sensitivity and range as you fish. You can also mark a particular depth and control how fast the sonar history scrolls across the screen. The menu options allow you to see more or less of the sonar returns from the transducer beams as you adjust each setting.

Adjusting Sonar Display Settings

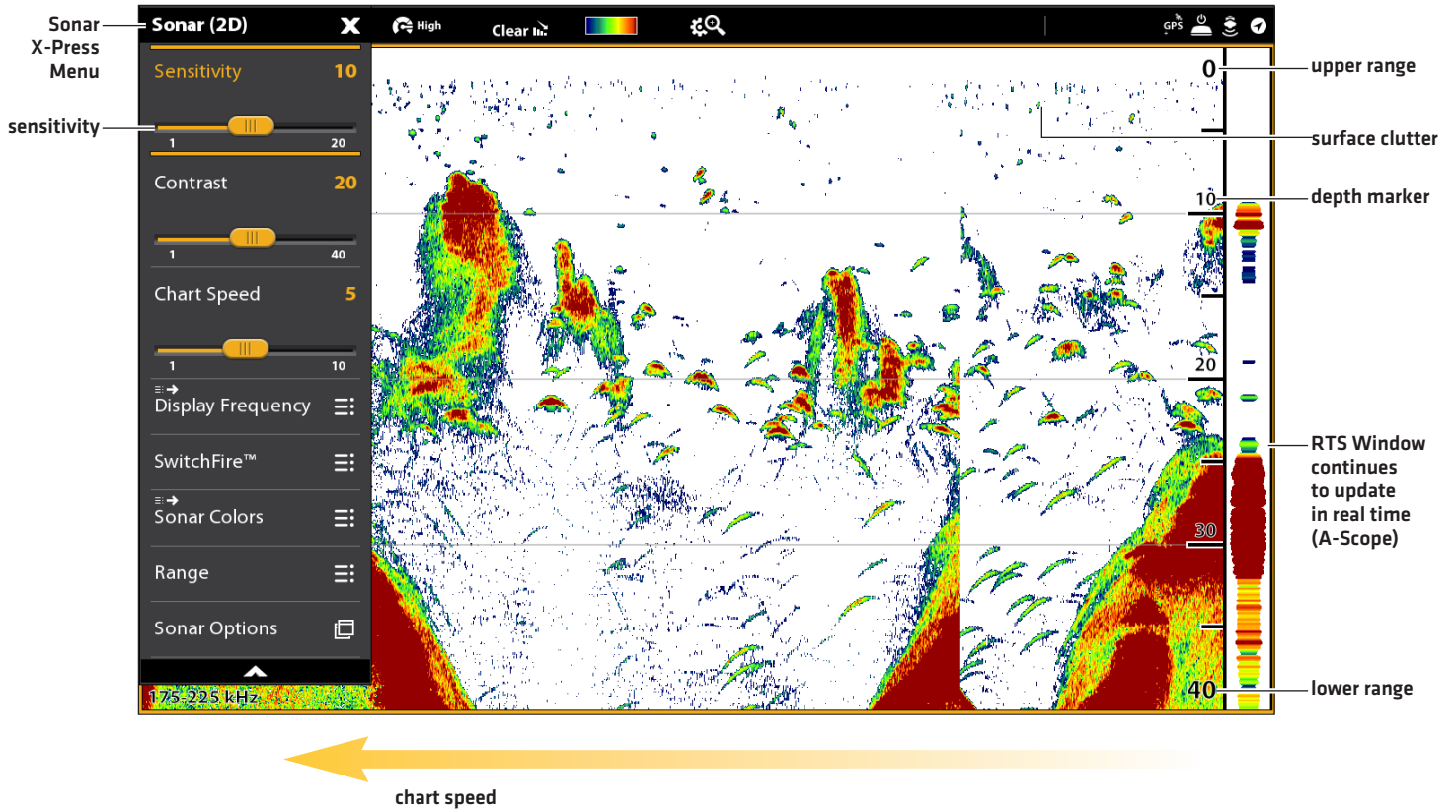

Adjust Display Settings

1. With a 2D Sonar View displayed on-screen, tap Sonar [2D] in the status bar, or press the MENU key once.
2. Select Sensitivity, Contrast, or Chart Speed.
3. Press and hold the slider, or turn the Rotary dial, to adjust the setting.

| | |
|--------------------|--|
| Sensitivity | Sensitivity controls how much detail is shown on the display and will adjust the sensitivity of all sonar frequencies. Decrease the sensitivity to eliminate the clutter from the display that is sometimes present in murky or muddy water. When operating in very clear water or greater depths, increase the sensitivity to see weaker returns that may be of interest.  QUICK TIP! This setting can also be changed by turning the Rotary dial. |
| Contrast | Contrast allows you to choose a range of the Sonar Colors palette to display sonar returns. When Contrast is set to 20 (default), the entire Sonar Colors palette (represented by the Color Bar) is used to display weak and strong sonar returns. As you increase the Contrast, the top range of the Color Bar is used to display all sonar returns (whether weak or strong). As you decrease the Contrast, the bottom range of the Color Bar is used to display all sonar returns (whether weak or strong). |
| Chart Speed | Chart Speed determines how fast the sonar history moves across the display and how much detail is shown. Select a faster speed to see more detail. Select a slower speed to keep the sonar history on the display longer. |

Filter Surface Clutter

Use Surface Clutter to reduce the noise that may appear at the top of the view caused by algae and aeration. The lower the setting, the less surface clutter will be displayed. A higher setting allows more surface clutter to be displayed.

1. With a 2D Sonar View displayed on-screen, tap Sonar [2D] in the status bar, or press the MENU key once.
2. Select Sonar Options > Surface Clutter.
3. Press and hold the slider, or turn the Rotary dial, to adjust the setting.

Change the SwitchFire Mode

SwitchFire controls how the sonar returns are displayed in the view.

1. With a 2D Sonar View displayed on-screen, tap Sonar [2D] in the status bar, or press the MENU key once.
2. Select SwitchFire.
3. Select Clear Mode or Max Mode.

SwitchFire: Clear Mode

Tap to open the SwitchFire menu in the status bar.

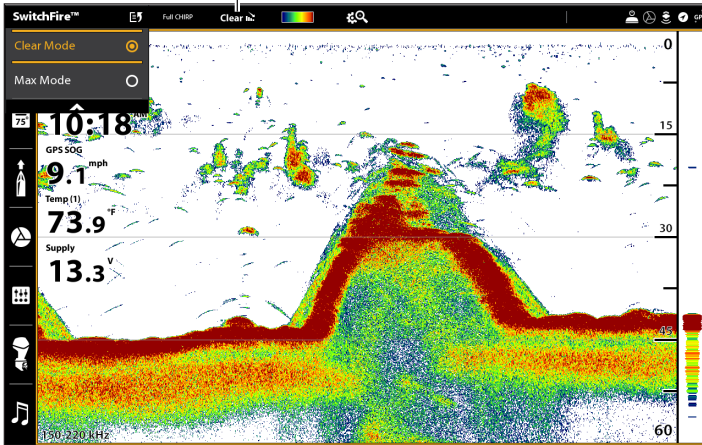

Choose Clear Mode to see less clutter and more fish size accuracy on the display. When Clear Mode is selected, the clutter is filtered, and sonar returns are interpreted to provide more details about the objects within the transducer beam, regardless of their location. In other words, a large arch on the display means a large fish has been detected.

SwitchFire: Max Mode

Tap to open the SwitchFire menu in the status bar.

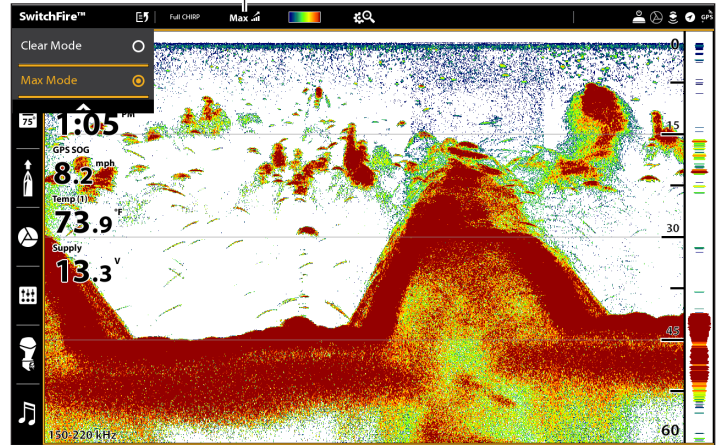

Choose Max Mode to see only raw sonar returns on the display. When Max Mode is selected, you will see the maximum sonar information available within the transducer beam, so more fish arches and better jig tracking are shown.



QUICK TIP! This setting can also be changed in the status bar menu. See the illustrations above.

Set the Range

Range controls how much of the water column is displayed on the view. For example, if you are only interested in the area between 20 and 50 feet deep, set the Upper Range to 20 and the Lower Range to 50. The view will not display sonar returns outside of the set ranges, and greater detail for the selected range will be displayed.

1. With a 2D Sonar View displayed on-screen, tap Sonar [2D] in the status bar, or press the MENU key once.
2. Select Range.
3. Select Upper Range. Press and hold the slider, or press and hold the ENTER key, to adjust the setting.
4. Select Lower Range.

Auto: Move the slider to Auto. The Lower Range will be adjusted by the control head to follow the bottom automatically.

Man [Manual]: Move the slider to Manual and adjust the setting.

Display the Depth Marker

To mark a specific depth on the view, turn on Depth Marker. This menu is available in Custom Mode [see *The Menu System: Change the User Mode*].

1. With a 2D Sonar View displayed on-screen, tap Sonar [2D] in the status bar, or press the MENU key once.
2. Select Sonar Options.
3. Select Depth Marker.
4. Tap the on/off button, or press the ENTER key, to turn it on.
5. Press and hold the slider, or press and hold the ENTER key, to adjust the setting.

Select Frequencies

If there are multiple beams available in a transducer, you can display individual frequencies on the 2D Sonar View. The menu options are determined by the installed transducer and control head model. See **Installation Information: Set up your Humminbird Network, Select Sonar Sources** and **Set up or Change Transducer Settings** for details.

Dual Beam CHIRP Models

1. With a 2D Sonar View displayed on-screen, tap the frequency menu in the status bar.

OR

Press the MENU key. Select Sonar Options > Preferences > Display Frequency.

2. Select a frequency from the list.



NOTE: If the control head is using a sonar source with only one beam frequency, the frequency list will not offer additional options.



QUICK TIP! This setting can also be changed by pressing and holding the ENTER key.

Dual Spectrum High Wide Models

1. With a 2D Sonar View displayed on-screen, tap the display spectrum menu in the status bar.

OR

Press the MENU key. Select Display Spectrum.

2. Select a spectrum from the list.

| | |
|---------------|--|
| Full | Select Full Beam [default] to use the complete frequency range. |
| Narrow | Select Narrow Beam for increased bottom detail and better target separation. |
| Wide | Select Wide Beam to maximize coverage and show big, clearly defined fish arches. |

2D Sonar View

Tap to open the Display Spectrum menu in the status bar.

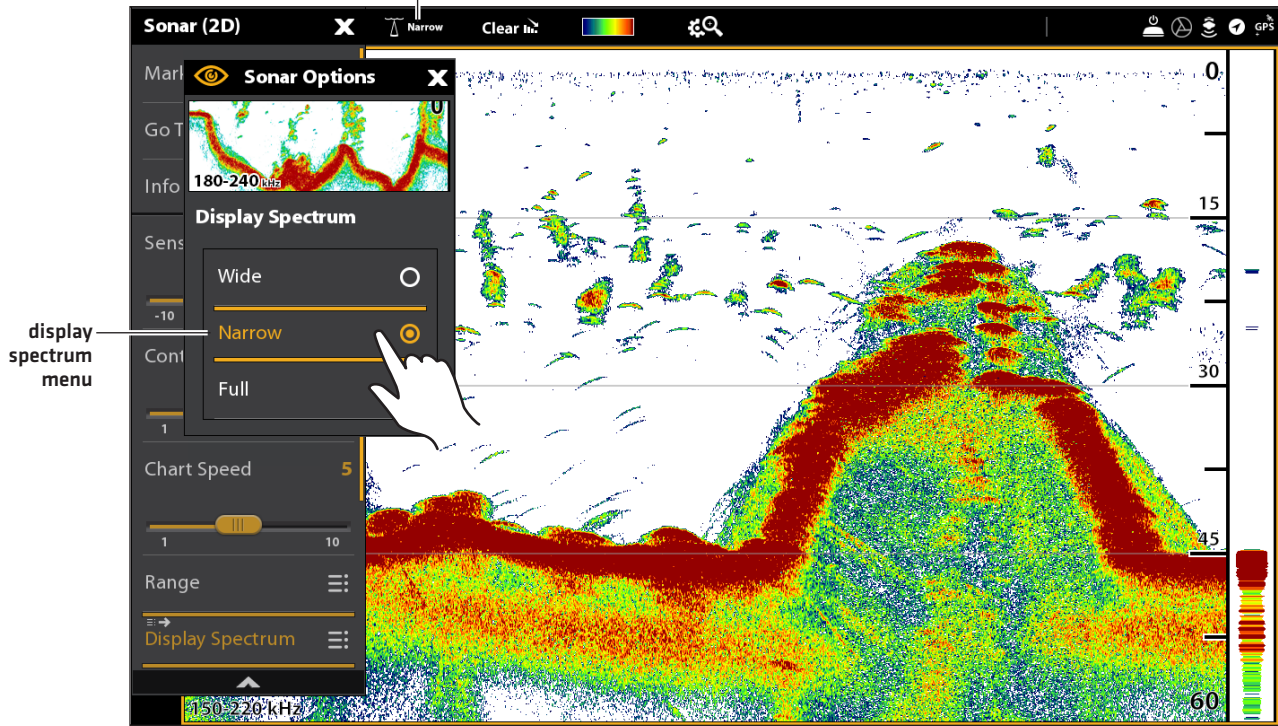

Tap to Select

OR



Press and Hold
to Change the Setting

Adjust Beam Sensitivity

Your control head model may allow you to adjust the sensitivity of individual frequencies. The available frequencies are determined by your control head model and the installed transducer. Use the following instructions to adjust a single beam.

1. With a 2D Sonar View displayed on-screen, tap Sonar [2D] in the status bar, or press the MENU key once.
2. Select Sonar Options.
3. Select Medium or High Sensitivity Offset.
4. Press and hold the slider, or turn the Rotary dial, to adjust the setting.

SIDE IMAGING OVERVIEW

(SIDE IMAGING TRANSDUCER REQUIRED)

Side Imaging beams “illuminate” the bottom contour, structure, and fish. The side beam coverage is very thin from front to back, yet very wide from top to bottom. The bottom composition determines the intensity of the sonar return, and upward slopes that face the transducer reflect sonar better than downward slopes that face away from the transducer.

Side Imaging View

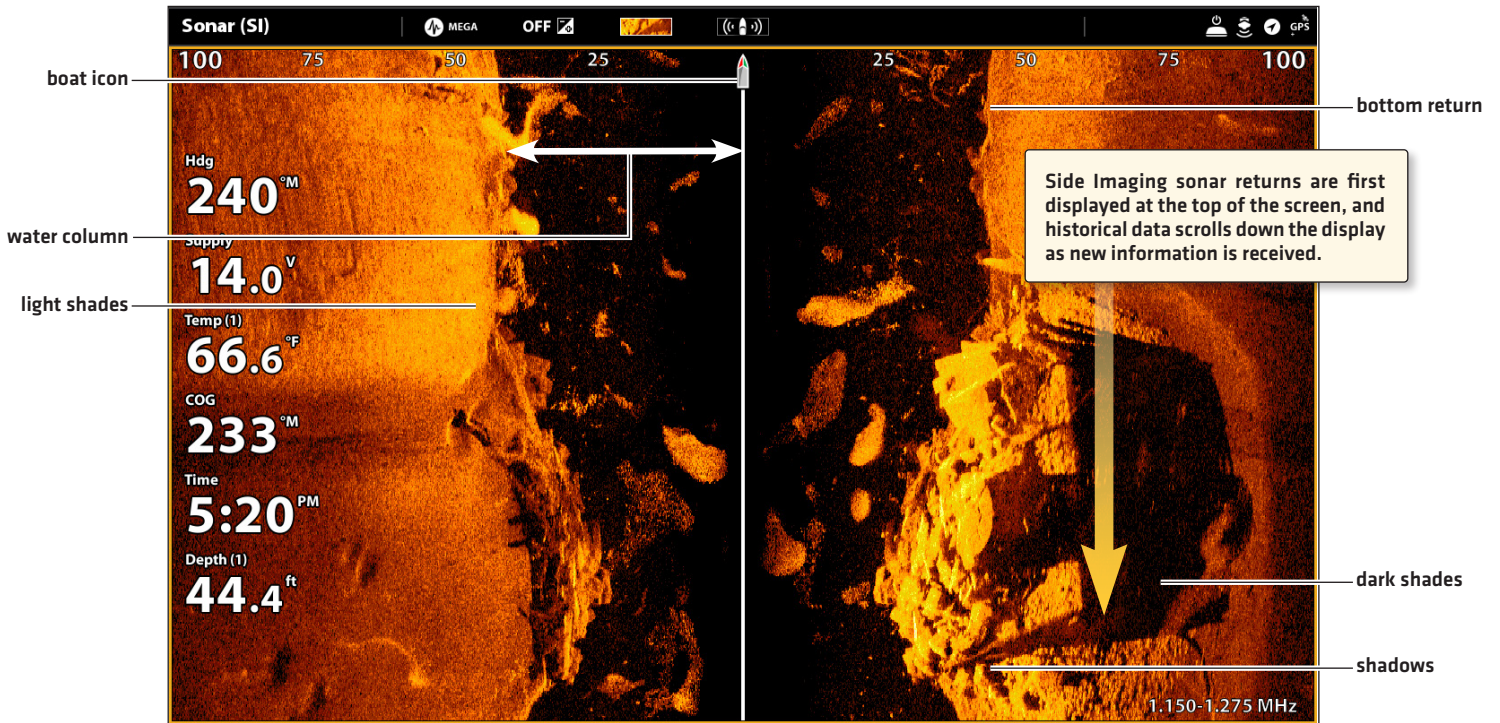

Use the light and dark parts of the display to interpret the objects on the view as follows:

Shadows: The longer the shadow, the taller the object. Fish also cast shadows, and their distance from the bottom can be interpreted by their shadow.

Light Shades represent denser terrain [possibly compacted sediment, timber, rocks] or rising terrain.

Water Column: shows the relative depth of the water under the vessel at any given time. Variations in the width of the water column show variations in the distance to the bottom as the vessel passes over. See the illustration *Interpreting the Side Imaging View*.

White Streaks or **Clouds** may represent fish on the display.

Dark Shades represent soft returns [possibly sand or mud] or descending terrain.

Interpreting the Side Imaging View

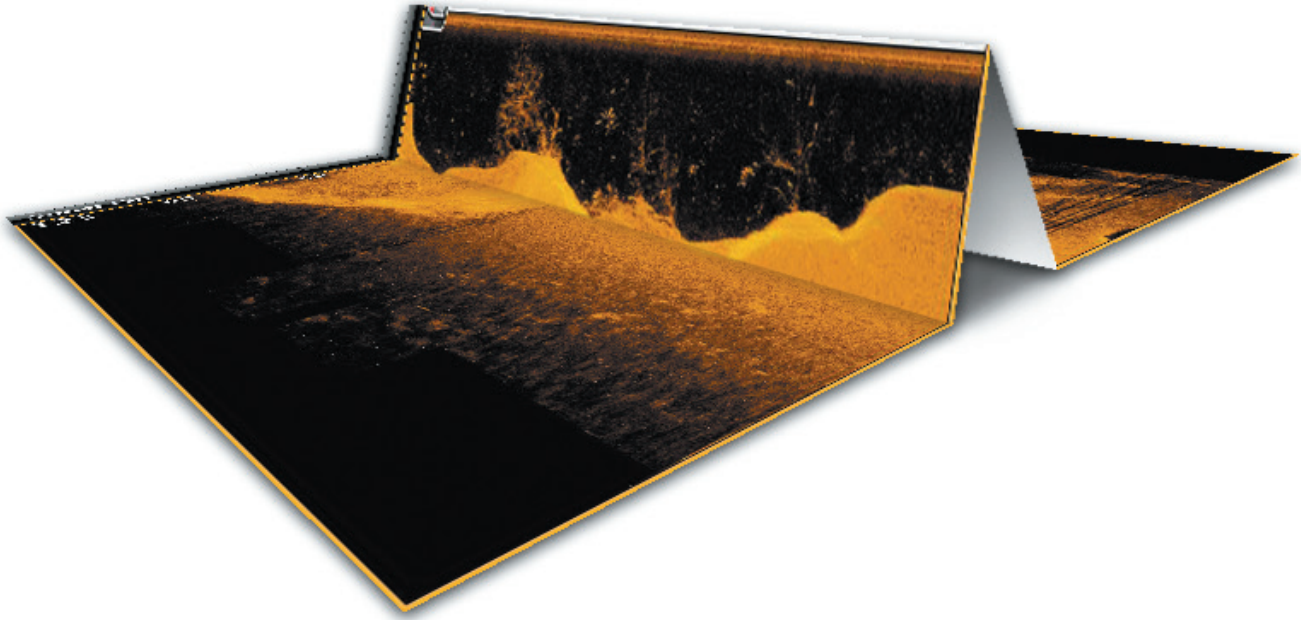

To visualize how Side Imaging works, the Side Imaging View illustration can be folded down the middle and then folded again at the lowest point of the water column. The raised area reveals the water column with its relative depth of the water under the vessel. In the Side Imaging View, variations in the width of the water column show variations in the distance to the bottom as the vessel passes over.

For Best Side Imaging Performance

- Vessel Speed: 2 to 6 mph
- Straight line navigation
- Minimum turning time and wave turbulence

Also, see humminbird.com for tutorials and Side Imaging videos.

CUSTOMIZE THE SIDE IMAGING VIEW

The settings in this section are optional. You can use the default settings for the view, or you can customize it with your preferences. See **Views** for more information.

OPEN THE SIDE IMAGING PREFERENCES MENU

The Preferences menu allows you to select a beam to display, set the zoom mode, return palette, and turn on Contour Mode and SI Navigation. For more information about view preferences, see **Views**.

1. With a Side Imaging View displayed on-screen, tap Sonar [SI] in the status bar, or press the MENU key once.
2. Select Sonar Options.
3. Select Preferences.

Select Beams to Display

The Side Imaging View displays both beams on the view. You can also choose to display the left side or the right side of the Side Imaging transducer beams.

1. From the Preferences menu, select SI Side.
2. Select a side to display.

Change the Color Palette

The Sonar Colors menu changes the colors used to display sonar returns on the view.

1. From the Preferences menu, select Sonar Colors.
2. Select a color palette.

Side Imaging View with a Customized Palette

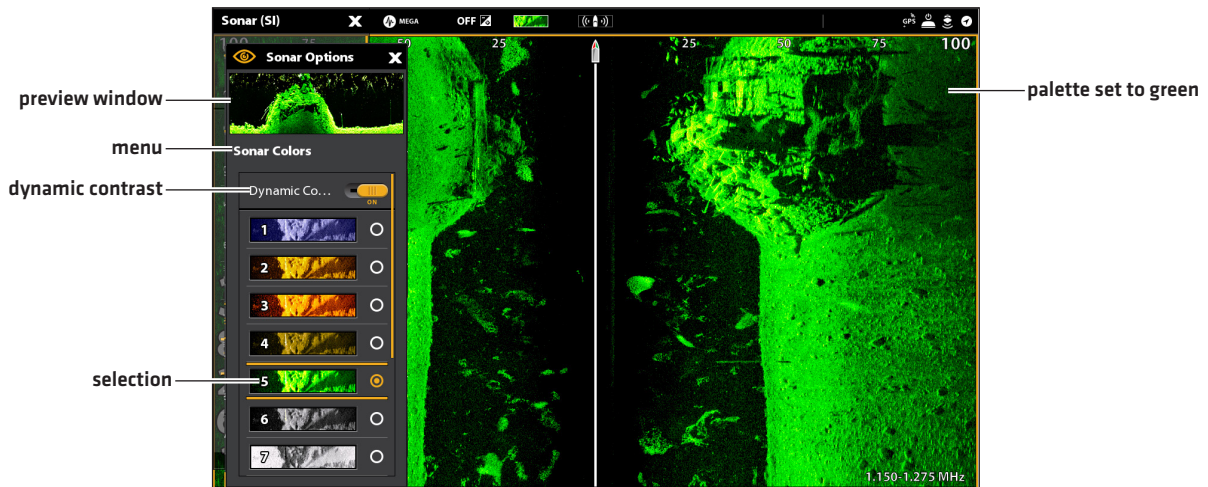

QUICK TIP! This setting can also be changed in the status bar menu.

Turn on/off Dynamic Contrast

Dynamic Contrast automatically enhances the contrast of the selected color palette.

1. From the Preferences menu, select Sonar Colors.
2. Under Dynamic Contrast, tap the on/off button, or press the ENTER key, to turn it on/off.

Turn on/off Contour Mode

Contour Mode controls how the water column is displayed in the Side Imaging Views. When Contour Mode turned off, the water column is displayed on the view. The location of a target on the display is based on the slant range to the target.

When Contour Mode is turned on, the bottom is graphed at a constant point on the display, regardless of changes in depth. The Side Imaging beams are divided by a vertical line. The water column is removed from the view, which allows the display to show targets at their linear horizontal distance. The location of a target may be easier to interpret when the water column is removed.

1. From the Preferences menu, select Contour Mode.
2. Tap the on/off button, or press the ENTER key, to turn it on/off.

Contour Mode Off

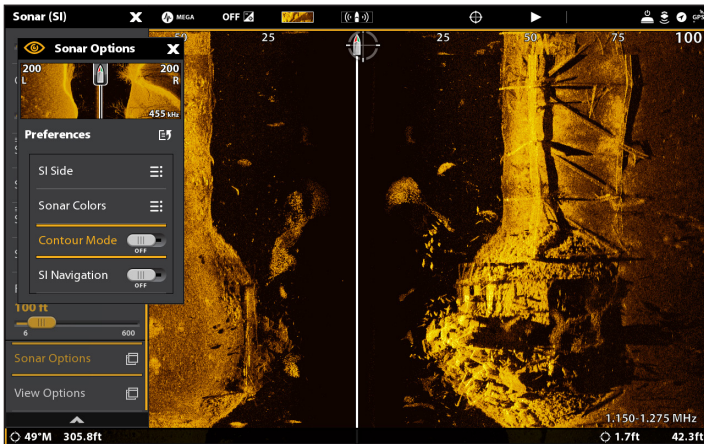

The water column is displayed on the Side Imaging View.

Contour Mode On

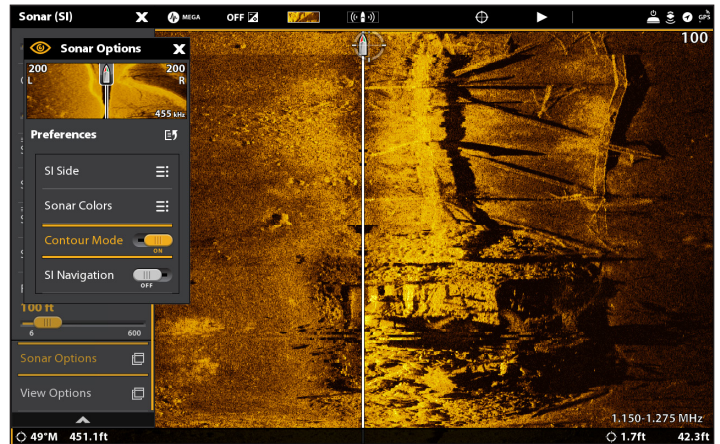

The water column is removed from the Side Imaging View.

Turn on/off SI Navigation

SI Navigation controls how the boat icon is displayed in Side Imaging Views. See *Navigation in Sonar Views* for more information. If SI Navigation is turned on, the boat icon indicates the direction the boat needs to turn to reach the next waypoint during navigation.

If SI Navigation is turned Off, the boat icon will not change during navigation although you can still mark waypoints and start navigation from a Side Imaging View.

1. From the Preferences menu, select SI Navigation.
2. Tap the on/off button, or press the ENTER key, to turn it on/off.

CHANGE THE SIDE IMAGING VIEW OVERLAYS

Use the Overlays menu to display or hide information on the view. In the Side Imaging View, you can display the following: boat icon, range lines, range intervals, side label, frequency label, and data overlays. To turn on the data overlay or data bar, see **Views: Edit the On-Screen View**. For more information about data overlays, see **Views**.

1. With a Side Imaging View displayed on-screen, tap Sonar [SI] in the status bar, or press the MENU key once.
2. Select Sonar Options.
3. Select Overlays.
4. Tap the menu, or use the Joystick to select an item, and add a check mark. [check mark = visible, blank = hidden].

Selecting Overlays for the Side Imaging View

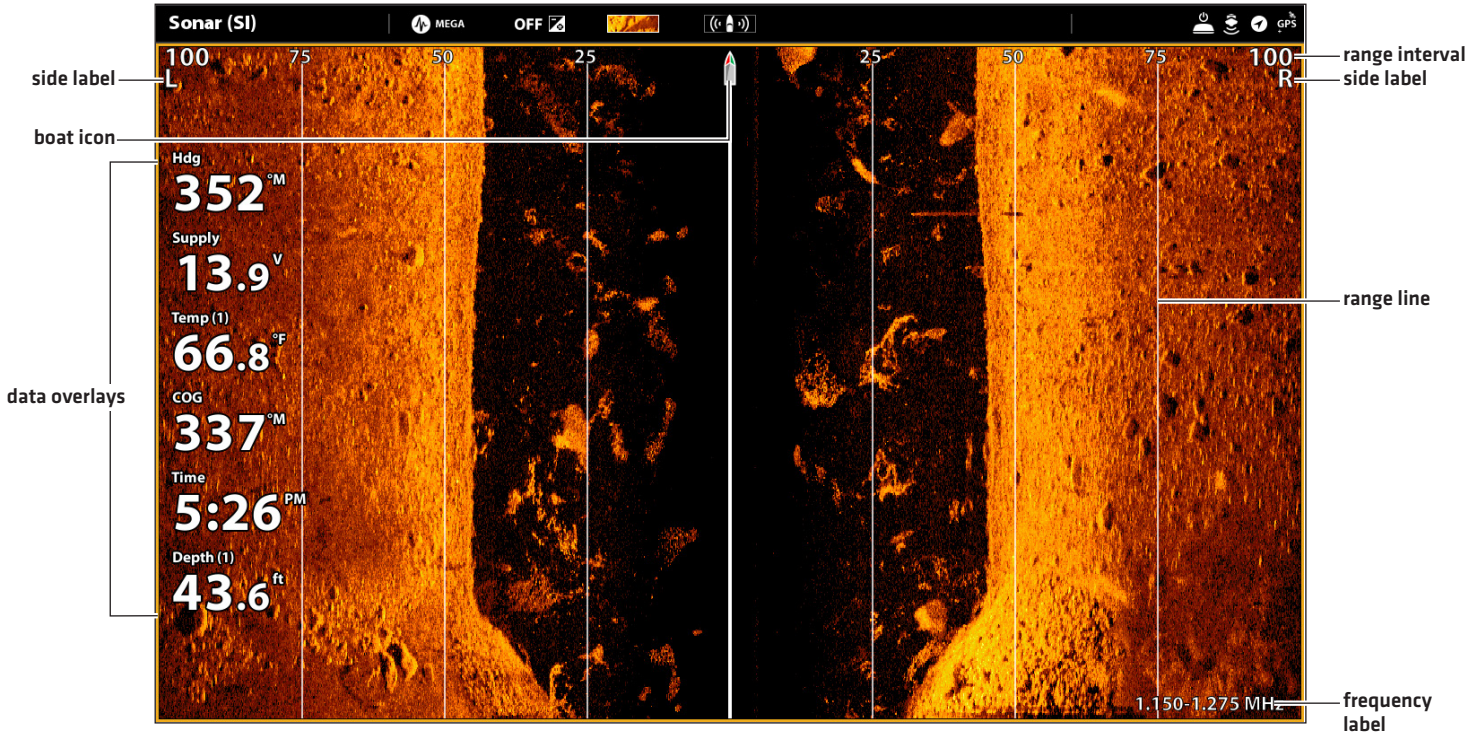

ADJUST SIDE IMAGING DISPLAY SETTINGS



The X-Press Menu provides menu options to adjust the sensitivity, contrast, sharpness, water column sensitivity, and range as you fish. You can also mark a particular range, and you can control how fast the sonar history scrolls across the screen. The menu options allow you to see more or less of the sonar returns from the transducer beams as you adjust each setting.

Adjust Display Settings

1. With a Side Imaging View displayed on-screen, tap Sonar [SI] in the status bar, or press the MENU key once.
2. Select Sensitivity, Contrast, Chart Speed, Water Column Sensitivity, or Sharpness.
3. Press and hold the slider, or turn the Rotary dial, to adjust the setting.

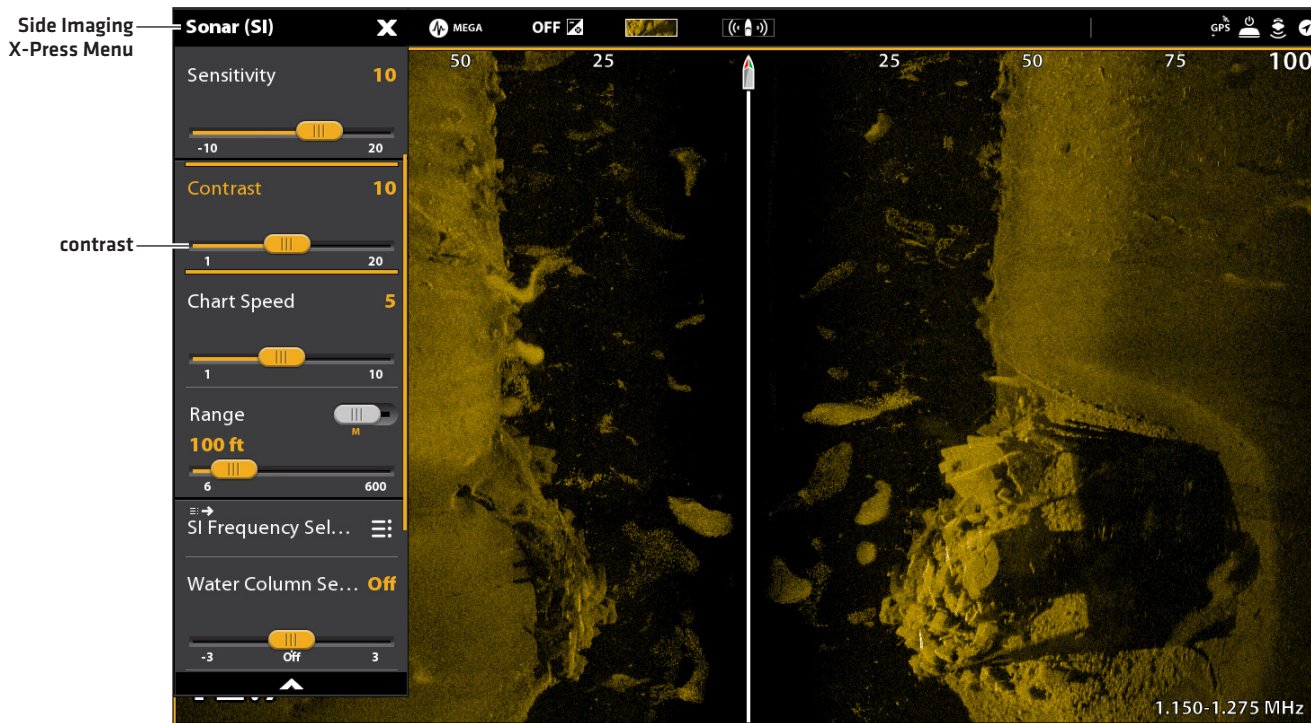
Adjusting Side Imaging Display Settings



| | |
|--------------------------|---|
| Sensitivity | <p>Sensitivity controls how much detail is shown on the display and will adjust the sensitivity of all sonar frequencies. Decrease the sensitivity to eliminate the clutter from the display that is sometimes present in murky or muddy water. When operating in very clear water or greater depths, increase the sensitivity to see weaker returns that may be of interest.</p> <p> QUICK TIP! This setting can also be changed by turning the Rotary dial.</p> |
| Contrast | <p>Adjust the Contrast setting to accent the light and dark parts of the Side Imaging data to provide greater definition.</p> |
| Chart Speed | <p>Chart Speed determines how fast the sonar history moves down the display and how much detail is shown. Select a faster speed to see more detail. Select a slower speed to keep the sonar history on the display longer.</p> |
| Water Column Sensitivity | <p>Adjust the setting to increase or decrease the sensitivity of the sonar return that is in the water column.</p> <p> QUICK TIP! This setting can also be changed in the status bar.</p> |
| Sharpness | <p>Turn on Sharpness and select a filter level to sharpen the edges of the Side Imaging data.</p> |

Set the Range

Range controls how much of the water column is displayed on the view.

1. With a Side Imaging View displayed on-screen, tap Sonar [SI] in the status bar, or press the MENU key once.
2. Select Range.
3. Tap the slider to select Auto or Man [Manual], or press the ENTER key.

| | |
|--------------|--|
| Auto | <p>The Range will be adjusted by the control head to follow the bottom automatically.</p> |
| Man [Manual] | <p>To adjust the display range, press and hold the slider, or press and hold the ENTER key. Select a low range number to focus on a shorter distance of the water column and see greater detail on the screen. Select a higher range number to view farther into the water and see an overview of details on the screen.</p> |

Display Range Markers

To mark a specific range on the view, turn on Range Marker. This menu is available in Custom Mode [see [The Menu System: Change the User Mode](#)].

1. With a Side Imaging View displayed on-screen, tap Sonar [SI] in the status bar, or press the MENU key once.
2. Select Sonar Options > Range Marker.
3. Select Left Marker or Right Marker.
4. Tap the on/off button, or press the ENTER key, to turn it on.
5. Press and hold the slider, or press and hold the ENTER key, to adjust the setting.

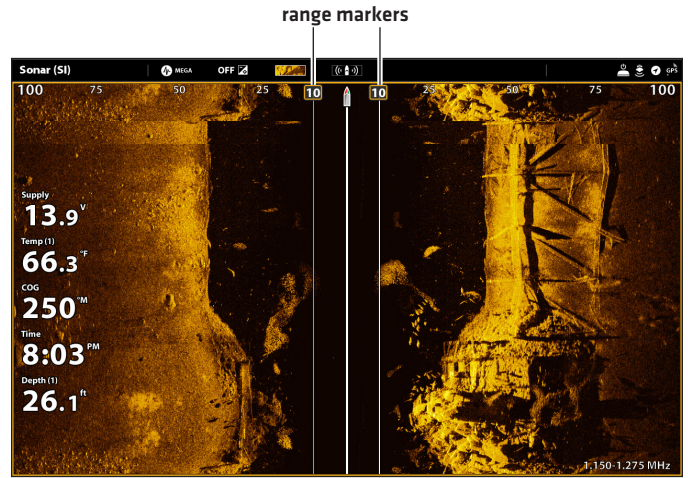

Select Frequencies

If there are multiple beams available in a transducer, you can display individual frequencies on the view. See [Installation Information: Set up your Humminbird Network](#), [Select Sonar Sources](#) and [Set up or Change Transducer Settings](#) for details.

1. With a Side Imaging View displayed on-screen, tap the frequency menu in the status bar.

OR

Press the MENU key. Select SI Frequency Select.

2. Select a frequency from the list.



NOTE: If the control head is using a sonar source with only one beam frequency, the frequency list will not offer additional options.



QUICK TIP! This setting can also be changed by pressing and holding the ENTER key.

Adjust the SI Sensitivity Offset

In the unlikely event that your Side Imaging transducers are not tuned to the same level, you can offset the left Side Imaging beam from the right Side Imaging beam.

1. With a Side Imaging View displayed on-screen, tap Sonar [SI] in the status bar, or press the MENU key once.
2. Select Sonar Options.
3. Select SI Sensitivity Offset.
4. Press and hold the slider, or turn the Rotary dial, to adjust the setting.

Adjusting the SI Sensitivity Offset

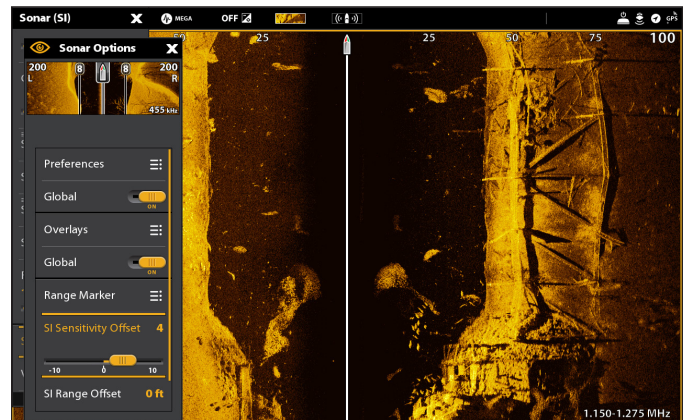

DOWN IMAGING OVERVIEW

(DOWN IMAGING TRANSDUCER OR SIDE IMAGING TRANSDUCER REQUIRED)

The images you see on the Down Imaging display are produced using sonar technology. Each time the unit pings, a strip of data representing all the echoes received by the transducer are put together on the display to form the image that you see. Like traditional 2D Sonar, the sonar history scrolls left across the screen.

Down Imaging beams “illuminate” the bottom contour, structure, and fish. The beams are wide [side to side] but very thin from front to back.

Down Imaging View: Original Palette

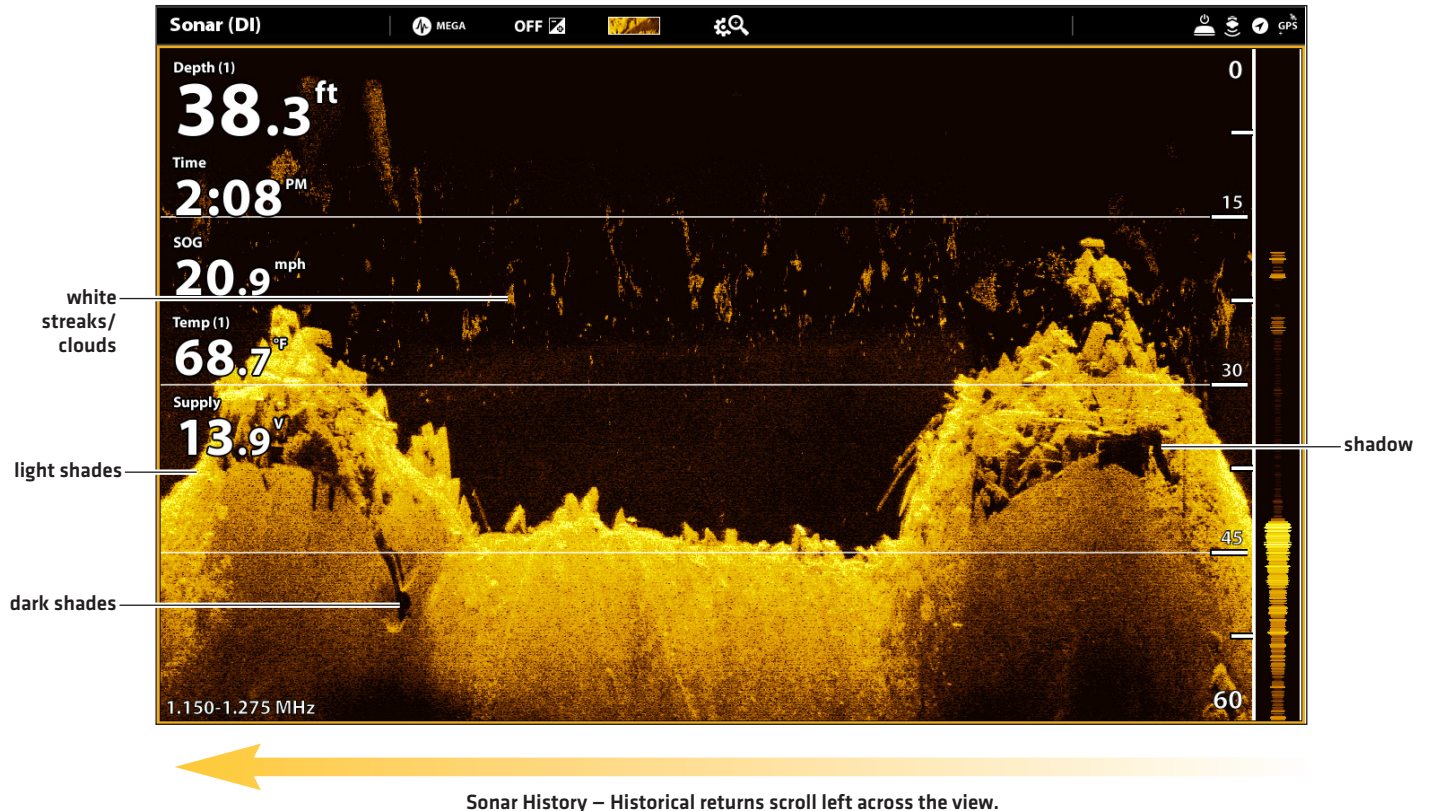

Use the light and dark parts of the display to interpret the objects under your boat as follows:

Dark shades represent soft returns [mud, sand] or descending terrain.

Light shades represent denser terrain [timber, rocks] or rising terrain. A very hard bottom may appear as white on the display.

White Streaks or **Clouds** may represent fish on the display.

Shadows are not caused by light but by the lack of a sonar return. Objects standing on the bottom cause a sonar shadow to appear on the display. The longer the shadow, the taller the object. Fish may also cast shadows. You can use the shadow to interpret where the fish or object is located in relation to the bottom.

CUSTOMIZE THE DOWN IMAGING VIEW

The settings in this section are optional. You can use the default settings for the view, or you can customize it with your preferences. See **Views** for more information.

OPEN THE DOWN IMAGING PREFERENCES MENU

The Preferences menu allows you to set the palette, zoom mode, and bottom line. For more information about view preferences, see **Views**.

1. With a Down Imaging View displayed on-screen, tap Sonar [DI] in the status bar, or press the MENU key once.
2. Select Sonar Options.
3. Select Preferences.

Change the Color Palette

The Sonar Colors menu changes the colors used to display sonar returns on the view.

1. From the Preferences menu, select Palette.
2. Select a color palette.

Down Imaging View with a Customized Palette

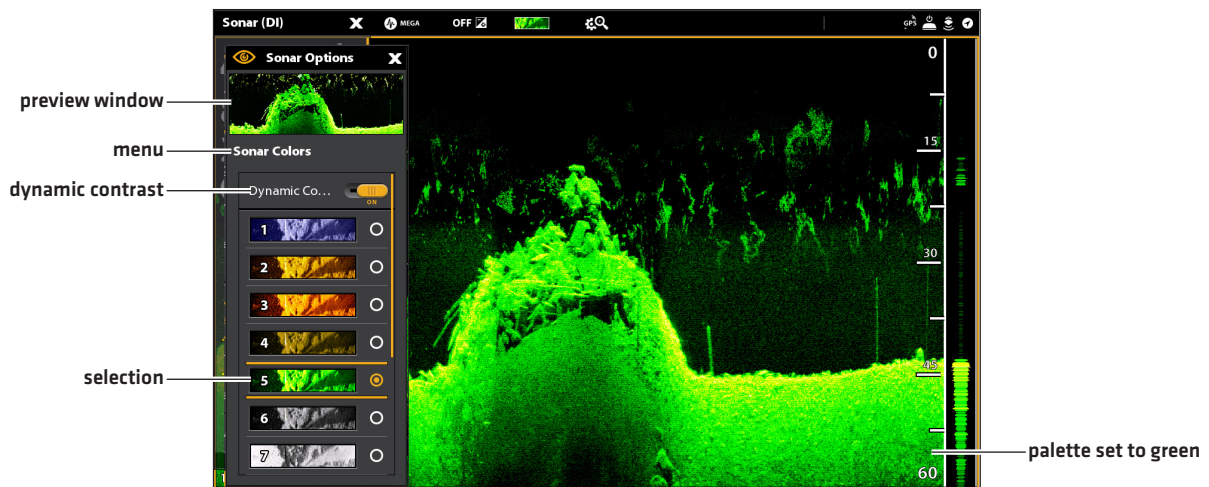

Turn on/off Dynamic Contrast

Dynamic Contrast automatically enhances the contrast of the selected color palette.

1. From the Preferences menu, select Sonar Colors.
2. Under Dynamic Contrast, tap the on/off button, or press the ENTER key, to turn it on/off.

Set the Zoom Mode

The Zoom Mode sets the zoom commands to magnify the full pane or the cursor selection. See *Use Cursor and Zoom in Sonar Views* to apply the zoom features.

1. From the Preferences menu, select Zoom Mode.
2. Select Pane Zoom or Cursor Zoom.

| | |
|-------------|---|
| Pane Zoom | When you use pinch out/in (touch screen) to zoom, or press the +/- ZOOM keys, the view will be magnified. |
| Cursor Zoom | When you use pinch out/in (touch screen) to zoom, or press the +/- ZOOM keys, the cursor selection will be magnified. |

Display the Bottom Line

Add a check mark to Bottom Line to display the depth reading from the Depth Source as a line, either from the selected transducer or another digital depth source. See *Set up your Humminbird Network* for details about selecting sources.

1. From the Preferences menu, tap Bottom Line or press the ENTER key.

Down Imaging View with Bottom Line Displayed

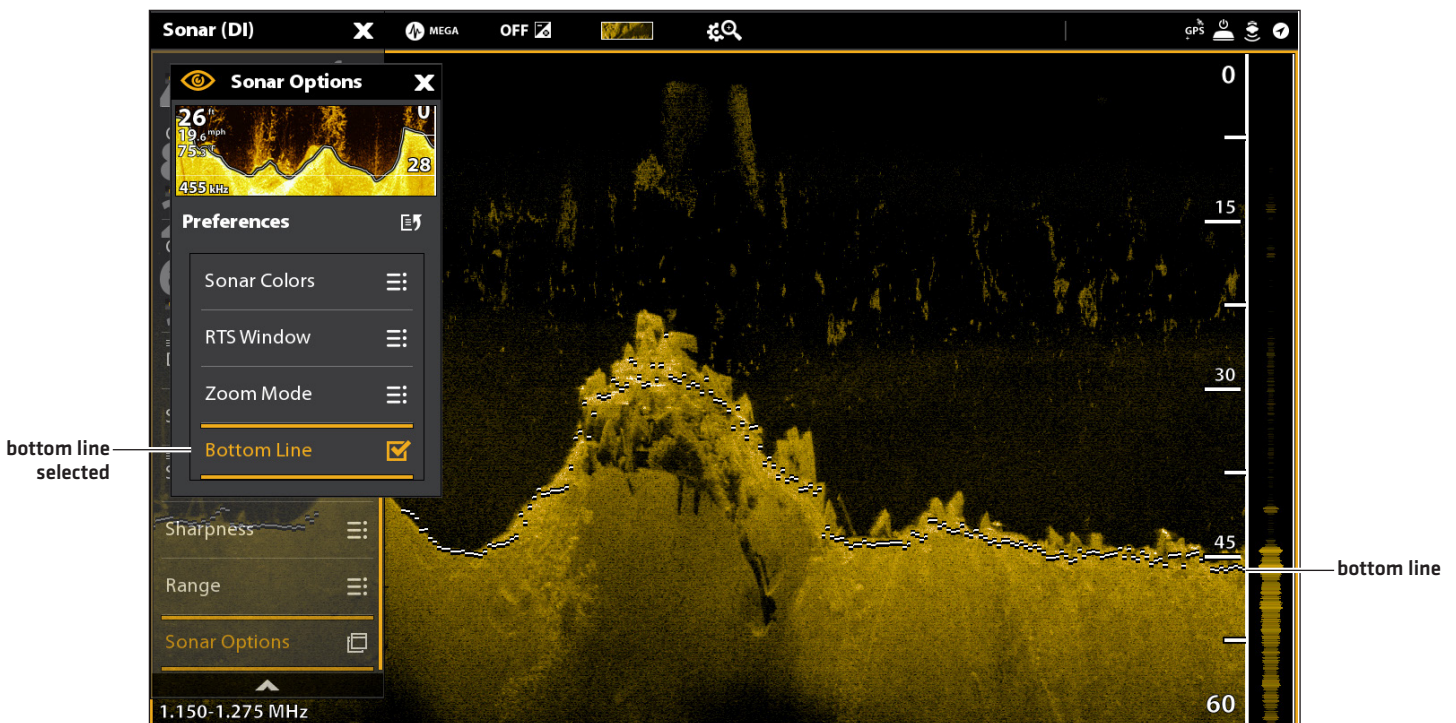

CHANGE THE DOWN IMAGING VIEW OVERLAYS

Use the Overlays menu to display or hide information on the view. In the Down Imaging View, you can display the following: depth range, beam frequency label, and data overlays. Digital readout data can be displayed as an overlay, and it can be displayed in the data bar. To turn on the data bar, see **Views: Display a Data Bar**. For more information about data overlays, see **Views**.

1. With a Down Imaging View displayed on-screen, tap Sonar [DI] in the status bar, or press the MENU key once.
2. Select Sonar Options.
3. Select Overlays.
4. Tap the menu, or use the Joystick to select an item, and add a check mark. [check mark = visible, blank = hidden].

Selecting Overlays for the Down Imaging View

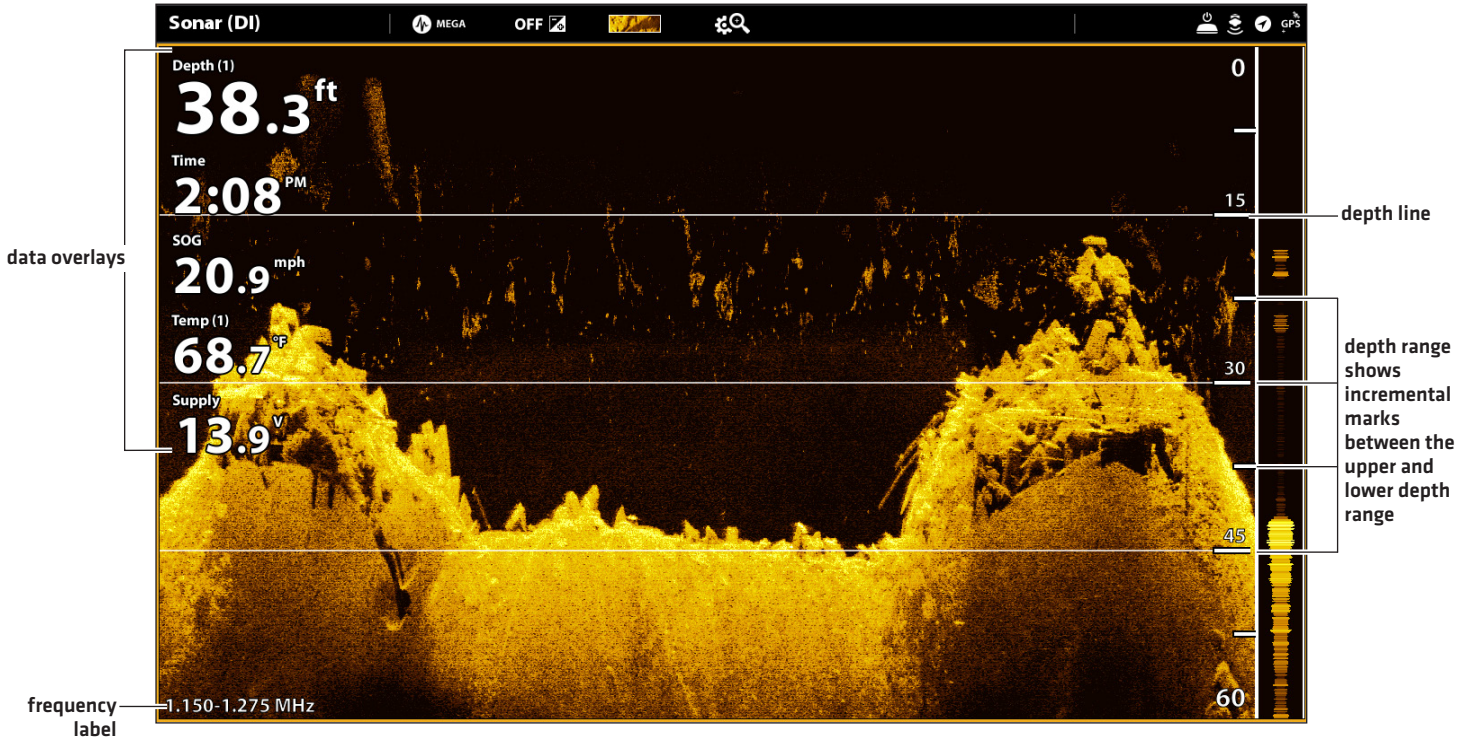

ADJUST DOWN IMAGING DISPLAY SETTINGS

The X-Press Menu provides menu options to adjust the sensitivity and range as you fish. You can also mark a particular depth, and you can control how fast the sonar history scrolls across the screen. The menu options allow you to see more or less of the sonar returns from the transducer beams as you adjust each setting.

Adjusting Down Imaging Display Settings

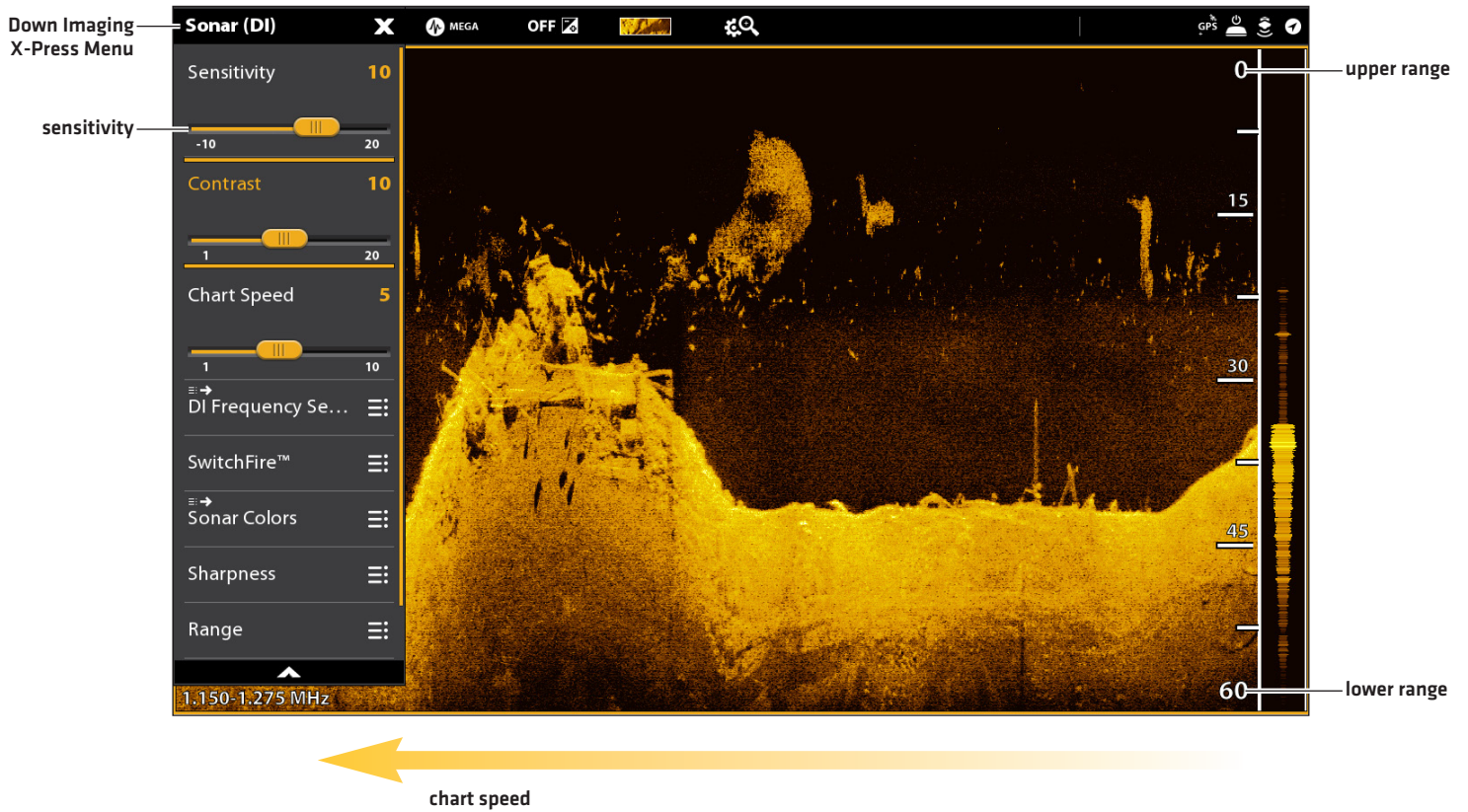

Adjust Display Settings

1. With a Down Imaging View displayed on-screen, tap Sonar (DI) in the status bar, or press the MENU key once.
2. Select Sensitivity, Contrast, Chart Speed, Water Column Sensitivity, or Sharpness.
3. Press and hold the slider, or turn the Rotary dial, to adjust the setting.

| | |
|---------------------------------|--|
| Sensitivity | Sensitivity controls how much detail is shown on the display and will adjust the sensitivity of all sonar frequencies. Decrease the sensitivity to eliminate the clutter from the display that is sometimes present in murky or muddy water. When operating in very clear water or greater depths, increase the sensitivity to see weaker returns that may be of interest. |
| Contrast | Adjust the Contrast setting to accent the light and dark parts of the Down Imaging data to provide greater definition. |
| Chart Speed | Chart Speed determines how fast the sonar history moves across the display and how much detail is shown. Select a faster speed to see more detail. Select a slower speed to keep the sonar history on the display longer. |
| Water Column Sensitivity | Adjust the setting to increase or decrease the sensitivity of the sonar return that is in the water column.  QUICK TIP! This setting can also be changed in the status bar. |
| Sharpness | Turn on sharpness and select a filter level to sharpen the edges of the Down Imaging data. |

Set the Range

Range controls how much of the water column is displayed on the view. For example, if you are only interested in the area between 20 and 50 feet deep, set the Upper Range to 20 and the Lower Range to 50. The view will not display sonar returns outside of the set ranges, and greater detail for the selected range will be displayed.

1. With a Down Imaging View displayed on-screen, tap Sonar [DI] in the status bar, or press the MENU key once.
2. Select Range.
3. Select Upper Range. Press and hold the slider, or press and hold the ENTER key, to adjust the setting.
4. Select Lower Range.

Auto: Move the slider to Auto. The Lower Range will be adjusted by the control head to follow the bottom automatically.

Man [Manual]: Move the slider to Manual and adjust the setting.

Display the Depth Marker

To mark a specific depth on the view, turn on Depth Marker. This menu is available in Custom Mode (see **The Menu System: Change the User Mode**).

1. With a Down Imaging View displayed on-screen, tap Sonar [DI] in the status bar, or press the MENU key once.
2. Select Sonar Options > Depth Marker.
3. Tap the on/off button, or press the ENTER key, to turn it on.
4. Press and hold the slider, or press and hold the ENTER key, to adjust the setting.

Select Frequencies

If there are multiple beams available in a transducer, you can display individual frequencies on the view. See **Installation Information: Set up your Humminbird Network, Select Sonar Sources** and **Set up or Change Transducer Settings** for details.

1. With a Down Imaging View displayed on-screen, tap the frequency menu in the status bar.

OR

Press the MENU key. Select DI Frequency Select.

2. Select a frequency from the list.



NOTE: If the control head is using a sonar source with only one beam frequency, the frequency list will not offer additional options.



QUICK TIP! This setting can also be changed by pressing and holding the ENTER key.

USE CURSOR AND ZOOM IN SONAR VIEWS

(2D, SI, DI)

You can use the cursor in the 2D Sonar, Side Imaging, and Down Imaging Views. With the cursor activated, you can magnify sonar returns on the view to get a closer look.

 **NOTE:** To display the 2D Sonar View in Split Zoom mode, see **Customize the 2D Sonar View: Change the Sonar Mode**.

Change the Zoom Mode

In 2D Sonar View and Down Imaging View, the sonar returns will be magnified based on the Zoom Mode setting. You can magnify the full view [Pane Zoom] or a selected area of the view [Cursor Zoom]. See **Customize the 2D Sonar View** or **Customize the Down Imaging View** for more information.

 **QUICK TIP!** You can also select this menu on the status bar.

Touch Screen

1. With a 2D Sonar View or Down Imaging View displayed on-screen, tap Sonar in the status bar.
2. Select Sonar Options.
3. Select Preferences.
4. Select Zoom Mode.
5. Select Pane Zoom or Cursor Zoom.

Keypad

1. With a 2D Sonar View or Down Imaging View displayed on-screen, press the MENU key once.
2. Select Sonar Options.
3. Select Preferences.
4. Select Zoom Mode.
5. Select Pane Zoom or Cursor Zoom.

Activate the Cursor

Touch Screen

1. Tap a position on the 2D Sonar, Down Imaging, or Side Imaging View.

Keypad

1. Move the Joystick.

Zoom In/Out

Touch Screen

1. **Zoom In:** Tap the position twice [double tap].
2. **Zoom Out:** Tap the screen with two fingers once [single tap].

OR

1. **Zoom In:** Touch the screen with two fingers and move them apart [pinch out].
2. **Zoom Out:** Touch the screen with two fingers and move them together [pinch in].

Keypad

1. **Zoom In:** Press the +ZOOM key.
2. **Zoom Out:** Press the - ZOOM key.

Using Cursor Zoom Mode [2D Sonar View]

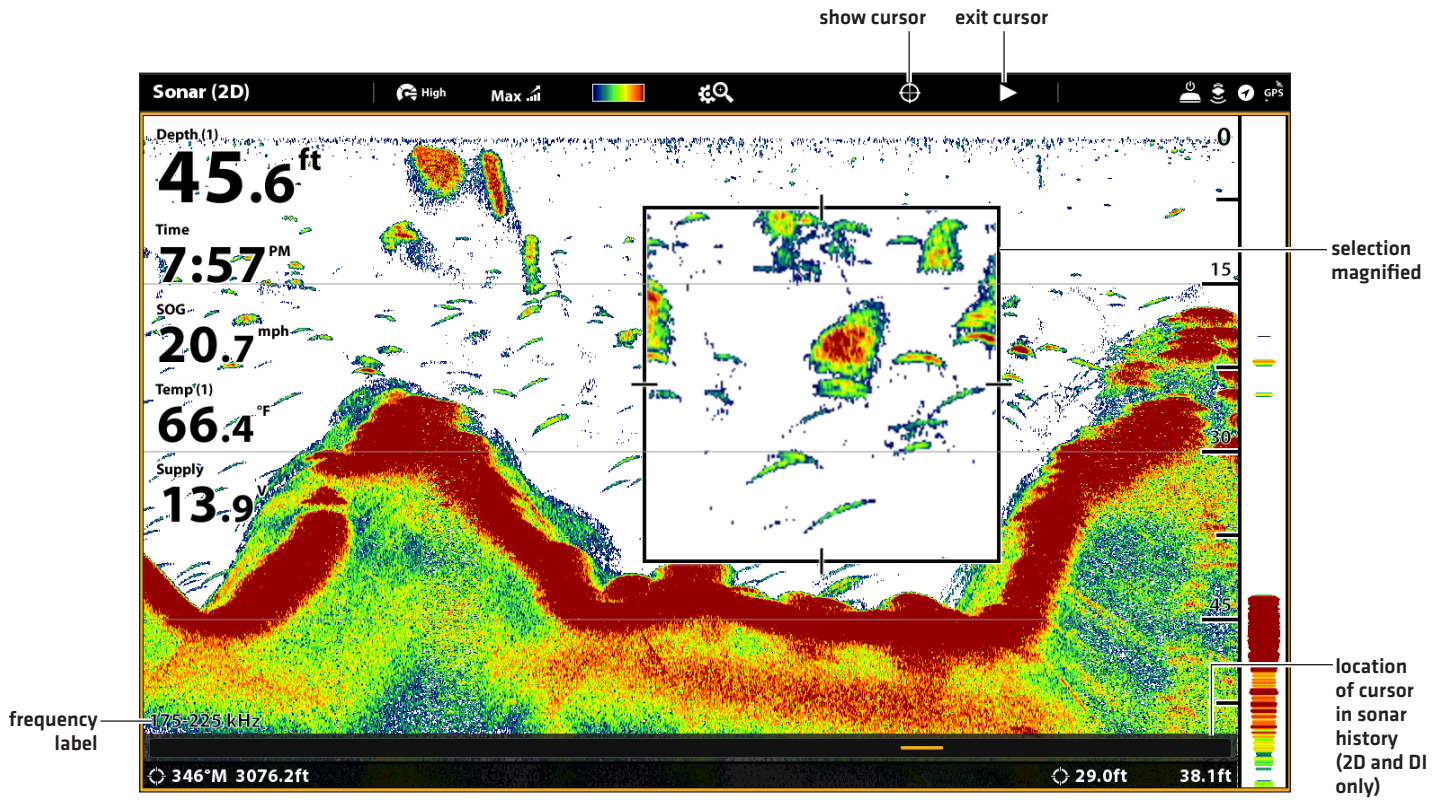

Tap to Activate the Cursor



Pinch out to Magnify the Selection

OR

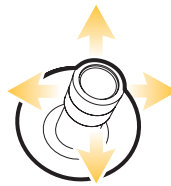

Move the Joystick to Activate the Cursor



Press the + ZOOM key to Magnify the Selection

To mark waypoints and start navigation, the control head must have a GPS fix from a connected or internal GPS receiver. The navigation menus can be accessed from the X-Press Menu, touch screen, and the keypad.

Mark a Waypoint

You can mark a waypoint on the Sonar Views using the keypad or touch screen. You can also mark a waypoint at the vessel position or the cursor position.

Mark a Waypoint at the Vessel Position

Touch Screen

1. Tap Sonar in the status bar.
2. Select Mark.
3. Select Waypoint.
4. Select a Waypoint icon from the Favorites menu.

Keypad

1. Press the MARK key twice.
2. Select a Waypoint icon from the Favorites menu.

Mark a Waypoint at the Cursor Position

Touch Screen

1. Press and hold a position on the Sonar View.
2. Select Waypoint.
3. Select a Waypoint icon from the Favorites menu.

Keypad

1. Use the Joystick to move the cursor to a position on the Sonar View.
2. Press the MARK key twice.
3. Select a Waypoint icon from the Favorites menu.

Marking a Waypoint (2D Sonar View)

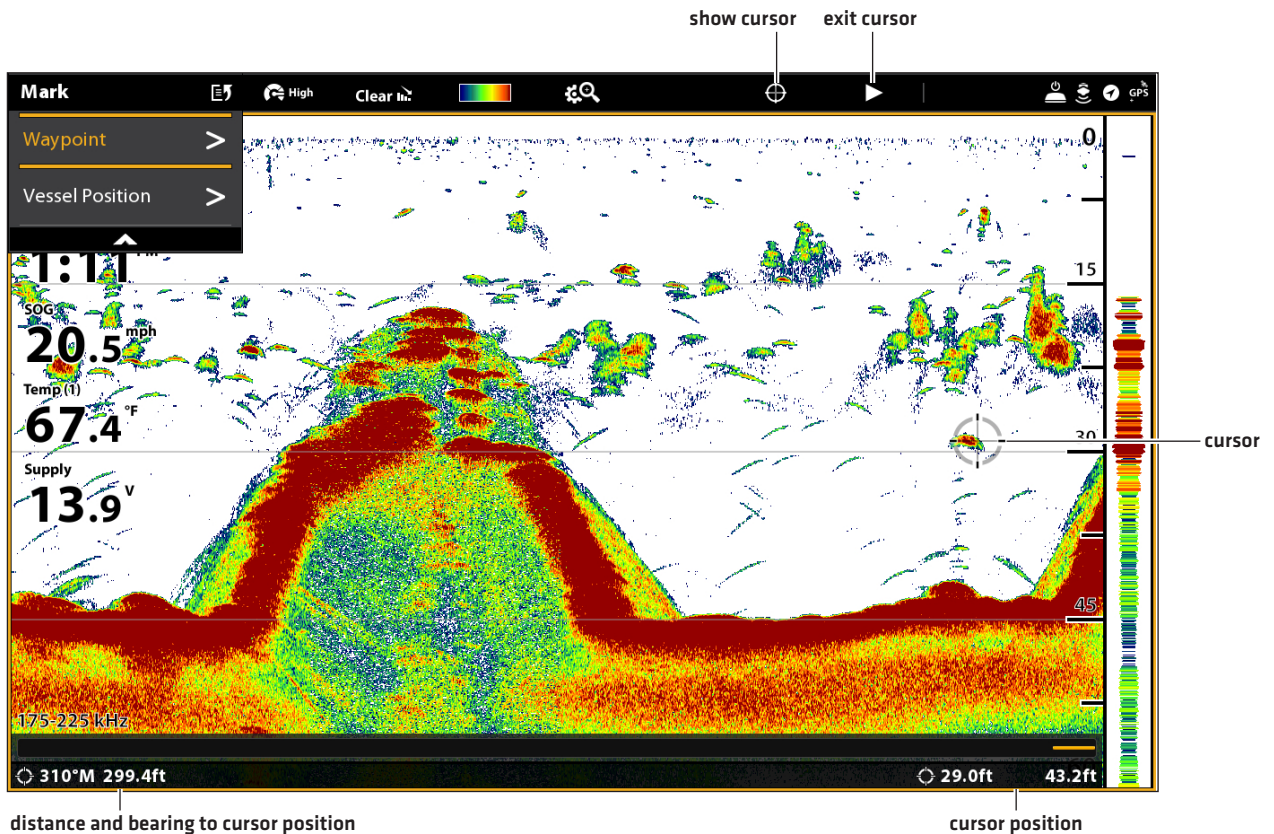

Navigate to a Position

Use the instructions in this section to start navigation to a position in the Sonar Views. See *Introduction to Navigation* for more information about these features.

Start Navigation

Touch Screen

1. Press and hold a position on the Sonar View.
2. Select Go To Cursor.

Keypad

1. Press the GO TO key.
2. **To start navigation to a saved position**, select Nav Data. Select a saved position, and press the GO TO key.
To enter a latitude/longitude position, select Lat/Long.
3. Continue to follow the on-screen prompts to start navigation.



NOTE: In Side Imaging Views, if SI Navigation is turned on, the boat icon will turn to indicate the direction the boat needs to turn to reach the next waypoint during navigation (see *Customize the Side Imaging View: Turn on/off SI Navigation*).

Cancel Navigation

1. During navigation, tap Sonar in the status bar. Select Go To.

OR

Press the GO TO key.

2. Select Cancel Navigation.

SONAR RECORDING

Use the Sonar Recording menu to record active sonar information. Sonar recordings are saved to an installed SD card, and you can play your saved sonar recordings from the Recordings tool. When the recording is played back, the views that were active during the recording are available. You can also adjust the view settings and mark waypoints during playback.

Start Recording

When you start a sonar recording, you can select which beams will be recorded and where the sonar recording will be saved.

1. Press the HOME key.
2. Select the Record tool.
3. Under Record Sonar, set up the sonar recording:
 - Select Recording Sources, and select the beams to be recorded.
 - Select Save Location, and select an installed SD card.
4. Select Start Recording.

Stop Recording

1. Press the HOME key.
2. Select the Record tool.
3. Under Record Sonar, select Stop Recording.

Play a Sonar Recording

1. Press the HOME key.
2. Select the Record tool.
3. Tap the recording name, or use the Joystick to select it.
4. Select Start.

Open the Playback Control Menu

The Playback Control menu includes stop, pause, forward or reverse for the recording played on the screen.

1. Play a sonar recording.
2. With a Sonar View [2D, SI, DI] displayed on-screen, tap Sonar in the status bar.

OR

- Press the MENU key once.
3. Select Sonar Playback.

IMAGES TOOL

The Images tool displays the screen snapshots saved to the control head or to the installed SD cards. You can edit, rename, copy, and delete a screen snapshot. You can also view your saved screen snapshots (JPG files) as a slide show, and you can change the Home screen background image.

Take a Screen Snapshot

Use the screen snapshot feature to take a picture of the on-screen view. The screen snapshot includes the warnings, menus, and messages that were active when the screen snapshot was taken. If Create Waypoint is turned on, a waypoint will be marked when you take the screen snapshot. See **Screen Snapshot Settings** for details.



1. Press and hold the GO TO/Screen Snapshot key.

Open the Images Tool

Open the Images tool to see all the screen snapshots saved to the control head, installed SD cards. You can also view each save location individually, and the images can be sorted by name, date, or file type.

Open the Images Tool

1. Press the HOME key.
2. Select the Images tool.

Browsing Screen Snapshots in the Images Tool

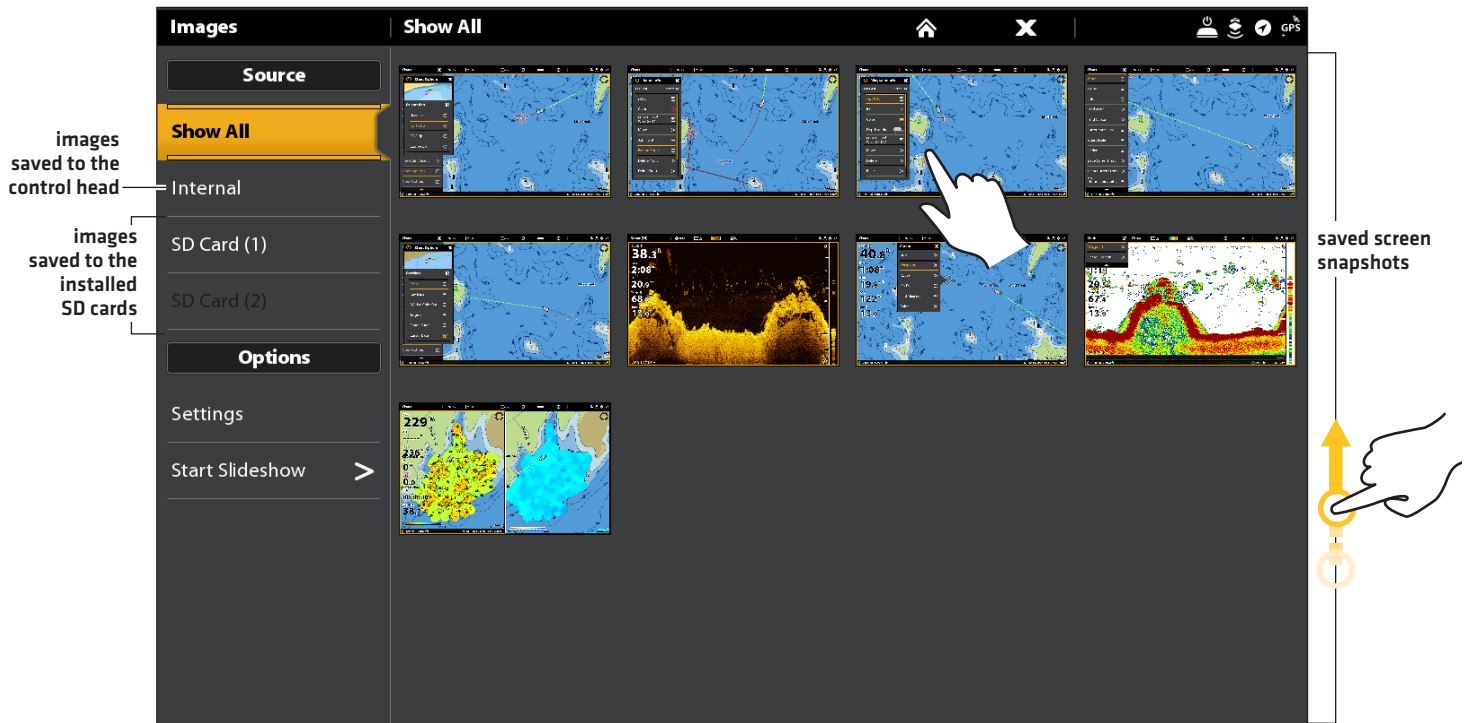

Sort Screen Snapshots

1. From the Images tool, select Settings.
2. Select Sort Options.
3. Select a sort option to sort by Name, Date, or File Type.

To view the images from newest to oldest, select Reverse Order. Tap the on/off button, or press the ENTER key, to turn it on.

Screen Snapshot Settings

Screen snapshots are automatically saved to the control head as JPG files. To save screen snapshots to an SD card, set up the save location in advance. If you turn on Create Waypoint, each time a screen snapshot is taken, the waypoint position will be saved.

Save Screen Snapshots to an SD Card

1. Install an SD card into a control head port.
2. Press the HOME key.
3. Select the Images tool.
4. Select Settings.
5. Under Screen Capture Save Location, select an installed source:

Control Heads with Vertical SD Card Slots: left port = SD Card 1 or right port = SD Card 2; default = Internal

Control Heads with Horizontal SD Card Slots: top port = SD Card 1 or bottom port = SD Card 2; default = Internal

Selecting a Save Location

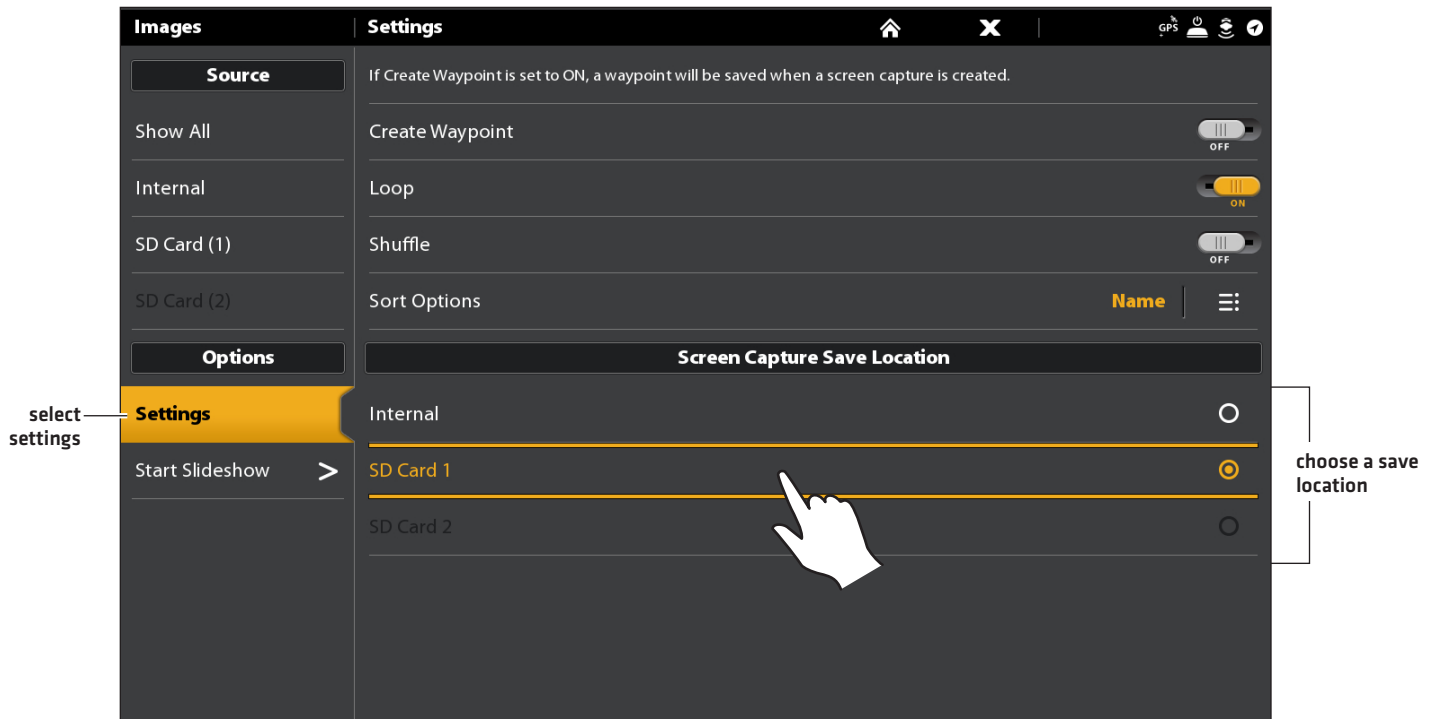

Create a Waypoint with Screen Snapshot

If you turn on Create Waypoint in the Images tool, each time a screen snapshot is taken, the waypoint position will be saved.

1. Press the HOME key.
2. Select the Images tool.
3. Select Settings.
4. Select Create Waypoint. Tap the on/off button, or press the ENTER key, to turn it on.

When a screen snapshot is taken with Create Waypoint turned on, the screen snapshot will display a waypoint icon in the Images tool preview.



screen snapshot saved with
Create Waypoint turned on

Display Screen Snapshots and Slideshow

When you select a saved screen snapshot (JPG file) from the Images tool, you can display it in full-screen using the touch screen or keypad.

Using the Touch Screen with a Saved Screen Snapshot

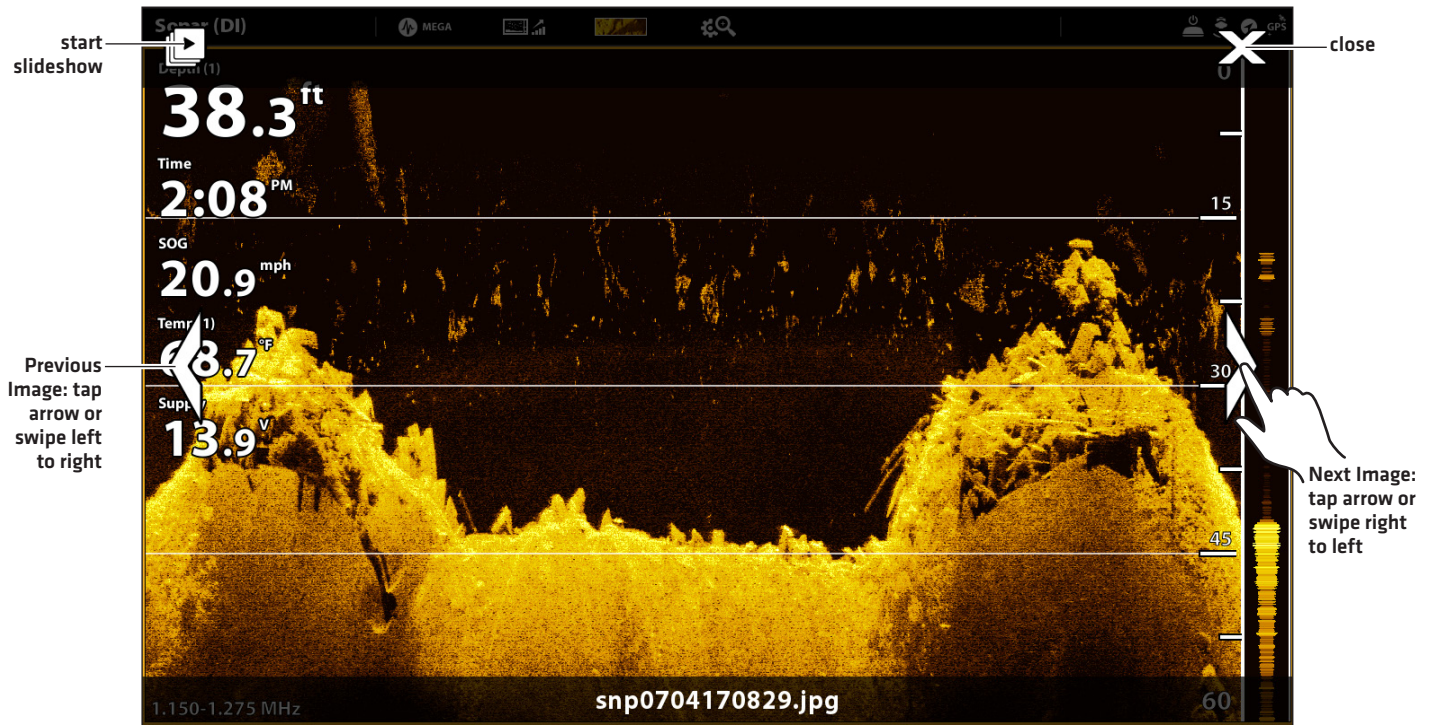

Display a Screen Snapshot

Touch Screen

1. From the Images tool, tap a screen snapshot.

Scroll to the Next Image/Previous Image:

Tap the on-screen arrows.

Return to the Images Tool:

Tap the on-screen X icon.

Keypad

1. Use the Joystick to select a screen snapshot.
2. Press the ENTER key.

Scroll to the Next Image/Previous Image:

Turn the Rotary dial.

Return to the Images Tool:

Press the EXIT key.

Set up the Slideshow

Screen snapshots and pictures from your camera's SD card can be displayed in a slideshow. You can use the control head default settings to play the slide show, or you can set the slideshow to loop or shuffle.

1. From the Images tool, select Settings.
2. To set up the slide show so it runs continuously, turn on Loop.
To set up the slide show so it displays screen snapshots randomly, turn on Shuffle.

Play the Slideshow

1. Under Options, select Start Slideshow.
2. **Stop:** Tap the screen, and press the X icon on the screen.

OR

Press the EXIT key.

Edit Screen Snapshots

The Images Options menu allows you to edit the name and review the file information for the selected screen snapshot. You can also copy screen snapshots to another save location or delete them.

Change a Screen Snapshot Name

1. From the Images tool, press and hold a screen snapshot.

OR

Use the Joystick to select a screen snapshot. Press the MENU key.

2. Select Name. Use the on-screen keyboard to enter a name.
3. Select Save.

Review Screen Snapshot Information

When you save a screen snapshot, the date and time the screen snapshot was taken is saved. If Create Waypoint is turned on, the position and waypoint name are also saved with the screen snapshot. Use these instructions to review the saved information.

1. From the Images tool, press and hold a screen snapshot.

OR

Use the Joystick to select a screen snapshot. Press the MENU key.

2. Select Info.

Copy a Screen Snapshot

1. From the Images tool, press and hold a screen snapshot.

OR

Use the Joystick to select a screen snapshot. Press the MENU key.

2. Select Copy.

To copy all screen snapshots, select Copy All.

3. Select a location to save the copy.

Delete a Screen Snapshot

1. From the Images tool, press and hold a screen snapshot.

OR

Use the Joystick to select a screen snapshot. Press the MENU key.

2. Select Delete.

To delete all screen snapshots, select Delete All.

INSTALLATION INFORMATION

This section includes information that may be required to connect new equipment or a new accessory to the control head. There are several configurations available for your APEX or SOLIX control head. You can network control heads, connect accessories to an Ethernet network, connect to a NMEA 2000 network, and add transducers to your system through black box sonar. For configuration options and the latest Humminbird accessories, visit our Web site at humminbird.com.

Installation guides are included with each hardware component to install equipment purchased separately (transducer, heading sensor, radar, AIS, autopilot, and accessories). See your installation guides for details.

Unused Ports: Any unused ports should be covered with the port covers to prevent potential damage to the control head.

Cables: We also recommend that you label the cables with waterproof tags for future reference.



WARNING! Before you connect cables to the control head, or disconnect cables, the control head power and equipment power sources must be turned off.



CAUTION! Before you update the control head software, synchronize units on the network, or restore system defaults, export your control head menu settings to an SD card. It is also recommended to export your navigation data to an SD card. See **Update Software** for details.



NOTE: If you have questions about the installation or troubleshooting, see your control head installation guide. Also, contact Humminbird Technical Support at humminbird.com.

SET UP OR CHANGE TRANSDUCER SETTINGS

(ADVANCED SETTINGS)

When you connect a transducer to a black box sonar or to the APEX/SOLIX control head, the transducer will be detected in the network automatically. The best transducer source will be chosen and start pinging automatically. If you connect an accessory transducer to the network, the unit will recognize the new transducer.

⚠ WARNING! The instructions in this section are advanced and not recommended for the typical user. Changing these settings incorrectly could damage the transducer.

📝 NOTE: For black box sonar and sonar networking information, see **Set up your Humminbird Network**. Also, to set up an Airmar transducer, or for troubleshooting information, download the Transducer Setup Guide from our Web site at humminbird.com.

📝 NOTE: Humminbird has provided the best settings for your unit. You can use the settings included with your control head, or you can adjust these advanced options.

Set up or Change Transducer Settings (not recommended)

Use the instructions in this section to enable a transducer with its complete functionality.

1. Press the HOME key.
2. Select Settings.
3. Select CHIRP Sonar.
4. Select Sonar Source.
5. Select Initial Setup.

If the transducer has been set up, but you want to change a transducer setup setting, select the  menu icon.

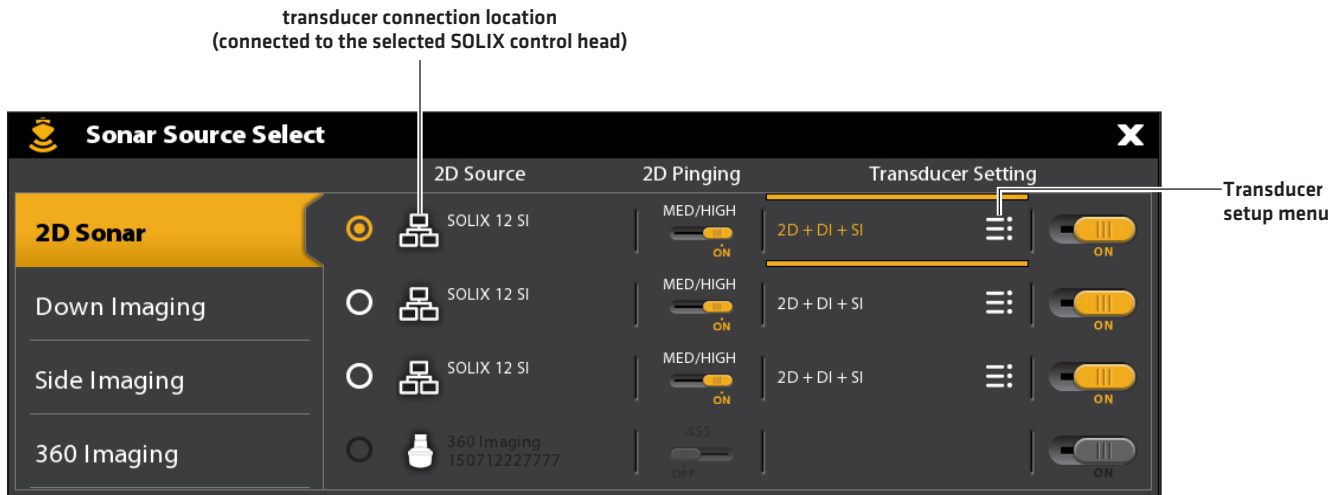

6. **Sonar Capabilities:** On the Transducer Setup menu, add a check mark next to each sonar capability for the selected transducer.

For example, for a 2D transducer, the 2D Sonar menu needs to be checked. For a Side Imaging transducer, 2D Sonar, SI Sonar, and DI Sonar need to be checked because the transducer includes all three capabilities. See the illustrations for examples.

 **NOTE:** The capabilities of your sonar model are shown on the packaging, or you can find your transducer on our Web site at humminbird.com.

7. **Frequencies:** Select the Frequency Capability Menu under each checked sonar capability. Confirm that all frequencies in the list are selected, so all frequencies are enabled. [You can select individual frequencies to view at a later time.]
 8. **Temp:** If the transducer includes a temperature probe, add a check mark to Temp.
 9. **Max Depth [optional]:** When Max Depth is set to Auto, the maximum depth is determined by the transducer frequency, and the control head will acquire bottom readings as needed [within the capacity of the unit]. Auto is the recommended setting for this menu.
- To manually set the Max Depth, select MAN [Manual], and adjust the slider to the maximum depth setting. The transducer will not attempt to acquire sonar data below that depth, so more detail will be shown on the sonar view.
10. **Depth Offset [optional]:** Depth Offset adjusts the digital depth readout to indicate the distance from the transducer to the waterline.
 11. Repeat the steps in this section for each transducer as needed.

 **NOTE:** Make sure all capabilities have a check mark so the full functionality of the transducer is enabled. To select sonar sources from the network, see **Set up your Humminbird Network**.

 **NOTE:** The menu options are determined by the connected transducer.

2D Transducer Setup (83/200 kHz or 50/200 kHz)

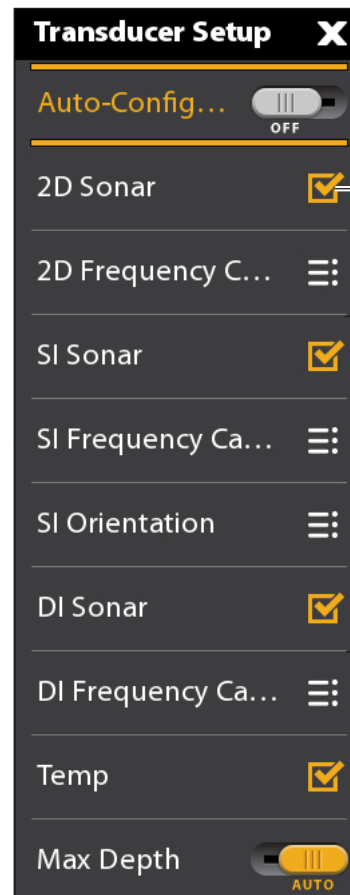

Add a check mark to 2D Sonar to enable 2D capabilities.

To enable the full functionality of the transducer, add a check mark to each category the transducer is capable of pinging.

Select Beams and Display Frequencies

If the selected transducer [sonar source] includes more than one beam, you can select which beam will be displayed in the sonar view. The beams selected in this menu affect all units that are sharing the sonar source. See **Set up your Humminbird Network: Select Sonar Sources** for details.

Select Frequencies for the 2D Sonar View (not recommended)

The frequencies selected in this menu affect all units that are sharing the sonar source. For example, if you select the blended Medium/High Frequency Select mode for one control head, and you select the single Medium Frequency Select mode on another control head, the control head with the single Medium Frequency selection will still be pinging the High Frequency in the background even though it is not displayed on the view.

 **NOTE:** Humminbird has provided the best settings for your unit. You can use the settings included with your control head, or you can adjust these advanced options.

 **QUICK TIP!** You can also select this menu on the status bar and in the X-Press Menu in 2D Sonar View.

1. Press the HOME key.
2. Select Settings.
3. Select CHIRP Sonar.
4. Under 2D CHIRP, select 2D CHIRP Frequency Select.
5. Select a frequency.

See the **Frequency Select Options** tables on the following pages. To access all beams in the 2D Sonar View, but view individual frequencies on different control heads, select Auto, Medium, or Medium/High Frequency.

Selecting 2D CHIRP Sonar Frequencies

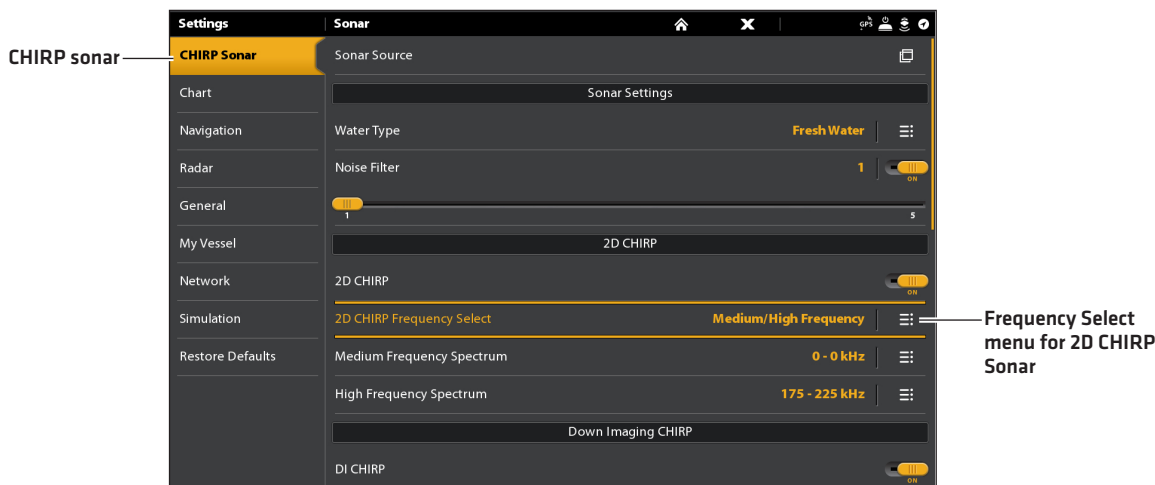

| 2D Frequency Select (CHIRP Off, On) | |
|-------------------------------------|--|
| Auto [recommended] | <p>Auto is the default selection. When Auto is selected, all sonar source beams are available for display in the 2D Sonar View.</p> <p>When Auto is selected, the transducer will only ping when the 2D Sonar View is being used, which may cause interruptions in the sonar history if the view is closed and then reopened. To display sonar history without interruption, select the blended Medium/High Frequency beams.</p> |
| Medium Frequency | <p>Select Medium Frequency for deep water [more than 800 feet]. Medium Frequency can be used for deep returns at high speed. If Medium Frequency is selected, the high frequency beam pings in the background but is not displayed.</p> |
| High Frequency | <p>Select High Frequency for more detail at shallower depths [less than 800 feet]. If High Frequency is selected, the medium frequency beam is not available.</p> |
| Medium/High Frequency | <p>Select Medium/High Frequency to ensure both beams ping continuously, so the sonar history is not interrupted if the Sonar View is closed.</p> <p>The returns from both beams are blended by starting with the wide beam return, dimming it, and then overlaying it with the narrow beam return. The narrow beam sonar returns will stand out from the wide beam sonar returns.</p> |

Select and Display Frequencies for the Side Imaging View (optional, CHIRP MEGA SI and CHIRP MEGA SI+ models only)

Use the instructions in this section to choose a frequency that will be used for the Side Imaging View.



QUICK TIP! You can also select this menu on the status bar and in the X-Press Menu in Side Imaging View.

1. Press the HOME key.
2. Select Settings.
3. Select CHIRP Sonar.
4. Under Side Imaging CHIRP, select SI Frequency Select and Display.
5. Select a frequency.

See the *SI Frequency Select and Display Options* table below.

| CHIRP MEGA SI Models SI Frequency Select and Display Options (CHIRP Off, On) | |
|---|--|
| MEGA+ | Select MEGA+ for the highest resolution, sharpness, and range [up to 500 ft side to side]. |
| MEGA | Select MEGA for the highest resolution, sharpness, and range [up to 250 ft side to side]. |
| 800 kHz | Select 800 kHz as an alternative frequency with sharp returns [up to 250 ft side to side]. |
| 455 kHz | Select 455 kHz for deep water and overall coverage [up to 800 ft side to side]. |

Select and Display Frequencies for the Down Imaging View (optional, CHIRP MEGA DI, MEGA DI+, MEGA SI, and MEGA SI+ models only)

Use the instructions in this section to choose a frequency that will be used for the Down Imaging View. The menu options are determined by the installed transducer and control head model.



QUICK TIP! You can also select this menu on the status bar and in the X-Press Menu in Down Imaging View.

1. Press the HOME key.
2. Select Settings.
3. Select CHIRP Sonar.
4. Under Down Imaging CHIRP, select DI Frequency Select and Display.
5. Select a frequency.

See the *DI Frequency Select and Display Options* table.

| CHIRP MEGA DI and MEGA SI Models DI Frequency Select and Display Options (CHIRP Off, On) | |
|---|---|
| MEGA+ | Select MEGA+ for the highest resolution, sharpness, and range (up to 250 ft). |
| MEGA | Select MEGA for the highest resolution, sharpness, and range (up to 125 ft). |
| 800 kHz | Select 800 kHz as an alternative frequency with sharp returns (up to 125 ft). |
| 455 kHz | Select 455 kHz for deep water and overall coverage (up to 400 ft). |

Adjust the CHIRP Frequency Spectrum (not recommended)

Your control head has been configured with the best settings for a wide range of fishing conditions, and we recommend using the default start and end CHIRP frequency spectrum included with your unit. However, you can adjust the CHIRP Frequency Spectrum to limit the interferences on the display or refine the settings to your preference. The menu options are determined by the installed transducer and control head model.

Requirements: CHIRP mode must be turned on. The menus are also determined by the display frequency you have selected for each view.



WARNING! If an accessory transducer is installed, confirm it is configured in the control head. See **Set up or Change Transducer Settings** for details. For information about accessory transducers, visit our Web site at humminbird.com.

Adjust the CHIRP Frequency Spectrum (2D CHIRP, SI CHIRP, DI CHIRP)(not recommended)

1. Press the HOME key.
2. Select Settings.
3. Select CHIRP Sonar.
4. Under 2D CHIRP, Down Imaging CHIRP, or Side Imaging CHIRP, select the Frequency Spectrum menu.
5. Select Start Frequency or End Frequency.
6. Press and hold the slider, or press and hold the ENTER key, to set the frequency.
7. **Repeat:** Repeat steps 5 and 6 to adjust both the Start Frequency and End Frequency.
8. **Close:** Press the EXIT key.
9. **Repeat:** Repeat steps 4 through 8 to set the Start Frequency and End Frequency for each sonar type and beam you are using.



NOTE: You can also adjust the single frequency range when CHIRP is off. See **Turn On/Off CHIRP Sonar**.

Setting the 2D CHIRP Frequency Spectrum

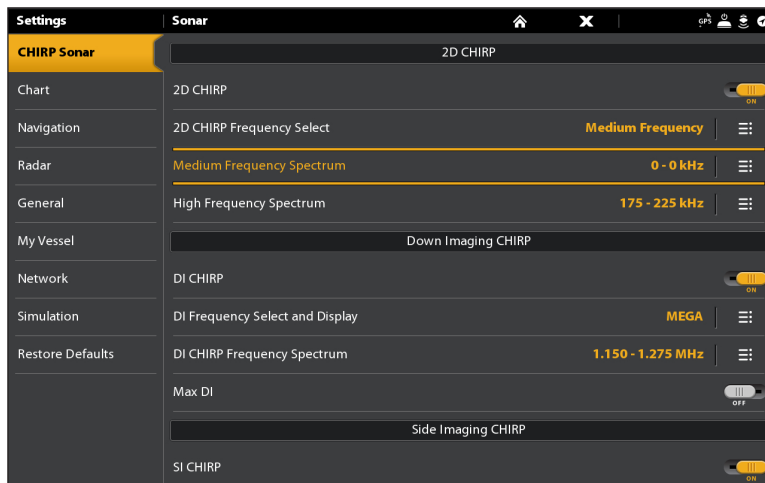

set the frequency spectrum for each beam

Turn On/Off CHIRP Sonar (not recommended)

To view digital CHIRP sonar, CHIRP must be turned on. To view single frequency sonar, turn CHIRP off. You can also adjust the single frequency range.

1. Press the HOME key.
2. Select Settings.
3. Select CHIRP Sonar.
4. Select 2D CHIRP, DI CHIRP, or SI CHIRP.
5. Tap the on/off button, or press the ENTER key, to turn it on or off.

Turning 2D CHIRP Sonar Off

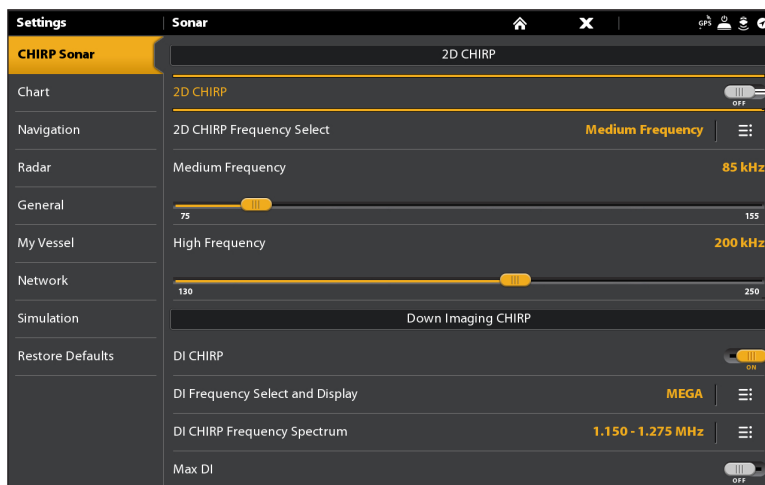

2D CHIRP set to off

set the single frequency range

Change the Water Type

Use the instructions in this section to change the Water Type setting.

1. Press the HOME key.
2. Select Settings
3. Select CHIRP Sonar.
4. Under Sonar Settings, select Water Type.
5. Select Fresh Water, Salt Water [200 ft [61 m] or deeper], or Salt Water Shallow [20 ft [6.1 m] or less]. Tap the item or use the Joystick to make your selection.

Adjust the Noise Filter (not recommended)

Use Noise Filter to limit the interference that may appear on the sonar views from sources such as your boat engine, turbulence, or other sonar devices.

1. Press the HOME key.
2. Select Settings
3. Select CHIRP Sonar.
4. Under 2D CHIRP, Down Imaging CHIRP, or Side Imaging CHIRP, select Noise Filter.
5. Tap the on/off button, or press the ENTER key, to turn it on.
6. Press and hold the slider, or turn the Rotary dial, to adjust the setting.

Change the Side Imaging Orientation (CHIRP MEGA SI models only)

Use SI Orientation to switch how the Side Imaging beams are displayed on the Side Imaging View. This menu option can be used if the port and starboard beams are reversed during installation, which might be the case if a transducer is installed incorrectly. For further assistance, contact Humminbird Technical Support.

1. Press the HOME key.
2. Select Settings
3. Select CHIRP Sonar.
4. Select Sonar Source.
5. Under Side Imaging, select the Side Imaging source.
6. Open the Transducer Setup menu. Select SI Orientation.
7. **To display the beams as the transducer[s] is installed**, select Normal.
To change how the beams are displayed so that port and starboard are switched, select Reverse.

Change Imaging+ Presets (MEGA SI+ and DI+ models only)

Use one of the Imaging+ Presets to change your frequency for maximum detail or maximum coverage.

1. Press the HOME key.
2. Select Settings.
3. Select CHIRP Sonar.
4. **DI+**: Under DI CHIRP Frequency Spectrum, select one of the presets: Increased Detail, Increased Depth.
SI+: Under SI CHIRP Frequency Spectrum, select one of the presets: Increased Detail, Increased Range.

The instructions in this section apply to the following Humminbird radar models only:

- RH 5
- RH 44
- AS 21RD4KW
- AS 12RD2KW



NOTE: The instructions in this section do not apply to the Humminbird CHIRP radar.

Radar Configuration

The radar should be configured by a qualified radar technician after installation or equipment repair. The settings in this section should only be needed periodically. We recommend that you contact Humminbird Technical Support at **1-800-633-1468** before using the menus in this section.



WARNING! The features in this section affect the performance of the radar and should only be adjusted by a qualified radar technician.



CAUTION! Before the radar settings are adjusted, or before the APEX/SOLIX software are updated or restored to system defaults, export the radar installation settings. See **Export Radar Installation Settings**.

Open the Radar Installation Menu

1. Press the HOME key.
2. Select Settings.
3. Select Radar > Installation.

Radar Installation Menu

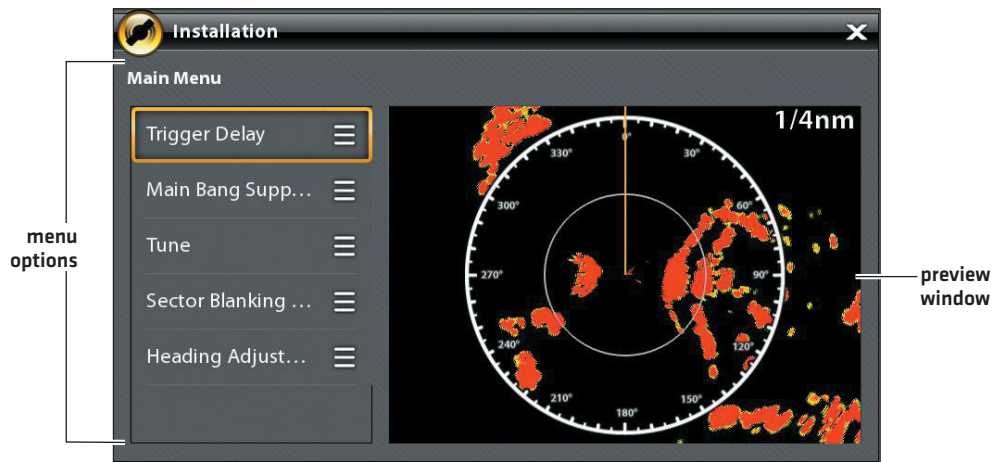

Trigger Delay

Trigger delay adjusts the signal timing so that long straight targets appear straight on the display. The Range and Rain Clutter (FTC) are temporarily adjusted to optimize the system settings. When the Trigger Delay installation setting is completed, the system will return to the previous user settings.

1. Select Trigger Delay from the Installation menu.
2. **Trigger Delay:** Press and hold the slider, or press and hold the ENTER key, to adjust the trigger delay. A high setting sets a longer delay, while a low setting sets the radar to a shorter delay.

3. **Gain:** Turn the Rotary dial to adjust the gain. The gain controls the amplification of the radar signal.
4. **Close:** Tap the Back icon, or press the EXIT key.

Main Bang Suppression

Set the Main Bang Suppression to create a range around the vessel, or the center of the radar pane, where the radar signal will be suppressed. The targets in this range will not be seen.

⚠ WARNING! Targets in the Main Bang Suppression Range are not displayed on the Radar View.

1. Select Main Bang Suppression from the Installation menu.
2. **Main Bang Suppression:** Press and hold the slider, or press and hold the ENTER key, to adjust the Main Bang Suppression range. A high setting sets a wider radius around the vessel and scanner, while a low setting limits the radius to a shorter range.
3. You can also adjust the following optional settings:
 - Gain** controls the amplification of the radar signal.
 - Sea Clutter** adjusts the filter that controls the amount of clutter on the view caused by rough sea conditions.
 - Rain Clutter** adjusts the filter that controls the amount of clutter on the view caused by rain or snow.
4. **Close:** Tap the Back icon, or press the EXIT key.

Tune the Radar

The technician can tune the radar automatically [Auto Tune] or enter specific settings manually [Manual Tune]. Tuning is used to optimize the radar system settings. For best results, run the tuning while there are targets within range, so it will be easier to review the data and make adjustments.

⚠ WARNING! The radar should only be tuned under very limited circumstances. Contact Humminbird Technical Support at **1-800-633-1468** before tuning the radar.

1. Select Tune from the Installation menu.
2. Select Auto Tune or Manual Tune.
 - Auto Tune:** When you select Auto Tune, the control head stops radar transmission and starts automatic radar tuning.
 - Manual Tune:** Select Coarse Adjustment or Fine Adjustment. Press and hold the slider, or press and hold the ENTER key, to adjust the settings.
3. **Close:** Tap the Back icon, or press the EXIT key.

Setting the Sector Blanking Range



Set the Sector Blanking Range

Sector Blanking sets an area where the radar will not scan. This setting is useful for preventing reflections or false echoes from displaying on the Radar View; however, any targets within this range are not displayed on the screen.



WARNING! Targets in the Sector Blanking Range are not displayed on the Radar View.

1. Select Sector Blanking from the Installation menu.
2. Select Sector Start. Press and hold the slider, or turn the Rotary dial, to set the start of the sector range.
3. Select Confirm. Tap the menu, or press the ENTER key.
4. Select Sector End. Press and hold the slider, or turn the Rotary dial, to set the end of the sector range.
5. Select Confirm. Tap the menu, or press the ENTER key.
6. Tap the Back icon, or press the EXIT key.

Adjust the Heading Line

Use the Heading Line setting to synchronize the on-screen heading with the actual vessel heading so that north is displayed correctly on the view.

1. Select Heading Adjustment from the Installation menu.
2. Press and hold the slider, or turn the Rotary dial, to adjust the heading line.
3. Tap the Back icon, or press the EXIT key.



WARNING! Humminbird is not responsible for the loss of data files (waypoints, routes, tracks, groups, snapshots, recordings, etc.) that may occur due to direct or indirect damage to the unit's hardware or software. It is important to back up your control head's data files periodically. Data files should also be saved to your PC before restoring the unit's defaults or updating the software. Visit our Web site at humminbird.com for details.

Export Radar Installation Settings

1. Install a formatted SD card into the SD card slot.
2. Press the HOME key.
3. Select the Files tool.
4. Under Export, select Radar Installation.
5. Select a save location.

Import Radar Installation Settings

1. Install a formatted SD card into the SD card slot.
2. Press the HOME key.
3. Select the Files tool.
4. Under Import, select Radar Installation.
5. Select the radar installation file.

CONFIGURE THE CONTROL HEAD

Use the instructions in this section to review control head and network connections, select baud rates and NMEA 0183 Output sentences, and name the control heads and networks.

When the APEX/SOLIX control head equipment and accessories are installed, the Setup Guide provides the prompts to guide you through configuring the unit. When you attach new hardware to the control head after it has been configured, the unit will detect the new hardware and provide additional prompts to add the equipment to the system.

System Info

Review System Connections

Use the System Info dialog box to review control head information such as the software version and serial number. You can also review connection information for the equipment connected to the control head ports, and you can change the control head name.

1. Press the HOME key.
2. Select Settings.
3. Select Network.
4. Select System Info.

System Info (APEX)

The screenshot shows the 'System Info' dialog box for an APEX control head. The dialog is titled 'System Info' and has a 'Total Time: 5 h' indicator with a close button (X). The main area lists various system parameters and their values. Annotations with arrows point to specific parts of the dialog:

- 'control head information' points to the Model, Unit Name, Serial Number, Software Version, IP Address, and MAC Address fields.
- 'network name' points to the Network Name field.
- 'control head ports and connection information' points to the Ethernet Port 1, Ethernet Port 2, Internal GPS, NMEA 0183 (1), NMEA 0183 (2), NMEA 2000, Transducer, MEGA 360 Imaging, Sonar Temp, Speed (Paddle Wheel), Aux Temp, HDMI IN, HDMI OUT, and Master Unit fields.
- 'rename the control head' points to the 'Rename Unit' checkbox.

| Parameter | Value |
|-----------------------|---------------------------|
| Model: | APEX 16 MSI+ CHARTPLOTTER |
| Unit Name: | 200715221822 |
| Serial Number: | 200715221822 |
| Software Version: | 3.897.(12/11/20 14:14) |
| IP Address: | 34:03:DE:FD:01:5C |
| MAC Address: | NET:200715221822 |
| Network Name: | NET:200715221822 |
| Ethernet Port 1: | Not Connected |
| Ethernet Port 2: | Not Connected |
| Internal GPS: | Not Connected |
| NMEA 0183 (1): | |
| NMEA 0183 (2): | |
| NMEA 2000: | Not Connected |
| Transducer: | Not Configured |
| MEGA 360 Imaging: | V0.000 S/N: 00000000-0000 |
| Sonar Temp: | Not Connected |
| Speed (Paddle Wheel): | Not Connected |
| Aux Temp: | Not Connected |
| HDMI IN: | Not Connected |
| HDMI OUT: | Not Connected |
| Master Unit: | --- |

Rename Unit

| Depth | Voltage | Position | Time/Date |
|---------|---------|----------------------------|-------------------------|
| 44.4 ft | 13.6 V | N 26.48386° W 82.05662° | 2:06:30 AM 3/15/2019 |

System Info (SOLIX)

System Info Total Time: 138 h X

| | | | |
|-----------------------|----------------------|----------------|-------------------|
| Model: | SOLIX 15 SI | Serial Number: | 161014220315 |
| Unit Name: | 161014220315 | IP Address: | 169.254.8.241 |
| Software Version: | 2.950(1/27/17 16:35) | MAC Address: | 74:DA:EA:08:B7:76 |
| Network Name: | NET:161014220315 | | |
| Internal GPS: | Not Connected | | |
| NMEA 0183 (1): | | | |
| NMEA 0183 (2): | | | |
| NMEA 2000: | Not Connected | | |
| Transducer: | Not Configured | | |
| Sonar Temp: | Not Connected | | |
| Speed (Paddle Wheel): | Not Connected | | |
| Aux Temp: | Not Connected | | |
| Master Unit: | Radar | | |

Rename Unit 

| Depth | Voltage | Position | Time/Date |
|---------|---------|------------------------------|------------------------|
| 45.6 ft | 13 V | N 34°12.954' W 83°57.678' | 1:40:04 PM 2/3/2017 |

Annotations:
control head information
network name
control head ports and connection information
rename the control head

Change the Control Head Name

When a control head is part of a network, you can change its name so it is easy to identify as a source on the network.

1. From the System Info dialog box [above], select Rename Unit. Use the on-screen keyboard to change the control head name.
2. Select Save.

Sensor Port Connections (GPS and NMEA 0183)

When equipment is connected to the control head, the equipment and its data will be detected automatically. You can also manually select data, set the data offset, baud rate, and NMEA output sentences from the Sensor Port submenus. The available menus are determined by the attached equipment.

1. Press the HOME key.
2. Select Settings.
3. Select Network.
4. Under Sensor Port, select a port menu.

GPS Port: If you've connected an external GPS or an external GPS/Heading Sensor to the control head, select the GPS Port. Use the GPS Port menu options to select the Sensor Type, Data Offset, and Pitch and Roll installation.

NMEA 0183 [1] and [2] allow you to change the data for Sensor Type, Data Offset, Baud Rate, and NMEA Output.

| | |
|--------------------|--|
| Sensor Type | <p>Auto-Select is turned on as the default setting, and the available data from the attached sensor will be auto-selected with a check mark.</p> <p>To change the selected data, turn off Auto-Select, and manually change the data by adding or removing a check mark. [check mark = selected]</p> |
| Data Offset | <p>To adjust the zero point of the attached sensor, select Data Offsets. Depending on the attached sensor, you can adjust the Depth Offset, Temperature Offset, Heading Adjustment, and STW [Speed Through Water] Calibration from this menu.</p> <p>For example, select Depth Offset to adjust the digital depth readout to indicate the depth from the waterline or the boat's keel for the selected sensor.</p> |
| Baud Rate | <p>Select a baud rate for the selected port. [Auto, 4800, 9600, 38400; Default = Auto]</p> |
| NMEA Output | <p>Select NMEA Output sentences for the selected port. See the NMEA 0183 table on the following pages.</p> |



NOTE: To set up a NMEA 2000 network, see **Set up a NMEA 2000 Network**.

NMEA 0183

| Message | Description | Input | Output |
|---------|---|-------|--------|
| AAM | Waypoint Arrival Alarm | | • |
| APB | Heading/Track Controller [Autopilot] Sentence "B" | | • |
| BOD | Bearing-Origin to Destination | | • |
| BWC | Bearing & Distance to Waypoint - Great Circle | | • |
| BWR | Bearing & Distance to Waypoint - Rhumb Line | | • |
| DBT | Depth Below Transducer | • | • |
| DPT | Depth | • | • |
| GGA | Global Positioning System Fix Data | • | • |
| GLL | Geographical Position - Latitude/Longitude | • | • |
| GNS | GNSS Fix Data | • | • |
| GSA | GNSS DOP and Active Satellites | • | • |
| GSV | GNSS Satellites In View | • | • |
| HDG | Heading, Deviation & Variation | • | • |
| HDM | Heading, Magnetic | • | • |
| HDT | Heading, True | • | |
| MTW | Water Temperature | • | • |
| MWD | Wind Direction & Speed | • | |
| MWV | Wind Speed & Angle | • | |
| RMB | Recommended Minimum Navigation Information | | • |
| RMC | Recommended Minimum Specification GNSS Data | • | • |
| ROT | Rate of Turn | • | • |
| VBW | Dual Ground/Water Speed | • | |
| VDM | AIS VHD Data Link [Other Vessels] | • | |
| VDO | AIS VHD Data Link [Own Vessel] | • | |
| VHW | Water Speed and Heading | • | • |
| VTG | Track Made Good & Ground Speed | | • |
| XDR | Transducer Measurements | • | |
| XTE | Cross-Track Error, Measured | | • |
| ZDA | Time & Date | • | • |

Configure the NMEA Talker ID

Use the following instructions to change the NMEA 0183 Talker ID to match the NMEA 0183 installed accessory.

1. Press the HOME key.
2. Select Settings > Network.
3. Under Sensor Port, select a NMEA port menu.
4. Select NMEA Output.
5. Under Configure NMEA Talker ID, select IN-Integrated Navigation [Default] or GP-Global Positioning System.

Set up Autopilot

If you are using a separate-purchase Humminbird autopilot [SC 110] with the APEX/SOLIX control head, it is important to review the following:

- Read the autopilot manual completely so you understand the installation and operation requirements before you use the equipment.
- There are many safety precautions that must be considered before you use the equipment. See the autopilot manual for more information.
- When you initiate navigation from the control head, there are certain controls that are NOT available on the autopilot. See the autopilot manual for more information.



WARNING! The autopilot system should be installed and configured by a Certified Marine Electronics Technician [CMET] or an authorized Marine Electronics Installer [MEI]. See NMEA.org for details. Incorrect installation may affect the system's performance, which affects the safety of the vessel and its passengers. Refer to the installation guide included with the autopilot. If you have questions about the installation, please contact Humminbird Technical Support.

Set up Autopilot

Use the following instructions to set up Autopilot on the APEX/SOLIX control head.

1. Select the control head that has the autopilot connected to it.
2. Press the HOME key.
3. Select Settings.
4. Select Network.
5. Under Sensor Port, select the port that is connected to the autopilot [NMEA 0183 [1], or NMEA 0183 [2]].
6. Select NMEA Output. Tap the on/off button, or press the ENTER key, to turn it on.
7. Under AutoPilot, select APB. Tap the check box, or press the ENTER key, to add a check mark to it.
8. To enable all modes of the SC 110 with the APEX/SOLIX control head, select the NMEA Output sentences as shown in the following table.

| | |
|-------------|---|
| Multisensor | RMC or VTG |
| Standby | n/a |
| Auto | n/a |
| Auto-Track | GGA or GLL or RMC |
| Nav | APA or APB or BOD + RMB or BOD + XTE or BOD + XTR |
| Wind | MWV or VWR |



NOTE: See the SC 110 manual and the SCP 110 manual for details. To download the manuals, visit our Web site at humminbird.com.

9. Press the EXIT key to return the previous menu.
10. Select Baud Rate. Select 4800.
11. Go to the Autopilot section of this manual to enable autopilot navigation with the control head.

SET UP A NMEA 2000 NETWORK

Use the instructions in this section if a NMEA 2000 network is connected to the control head.

When equipment is connected to the control head, the equipment and its data will be detected automatically. You can also manually select equipment and set the data offset. The available menus are determined by the attached equipment.



NOTE: Humminbird recommends that the NMEA 2000 network be installed by a certified NMEA 2000 technician. See NMEA.org for details.

Preparation

The NMEA 2000 network connects to the NMEA 2000 port on one control head. If you have a multi-control head network, select the control head that is connected to the NMEA 2000 network backbone to proceed with the following instructions.

Open the NMEA 2000 Sensor Port Menu

1. Press the HOME key.
2. Select Settings.
3. Select Network.
4. Under Sensor Port, select NMEA 2000.

Turn on the NMEA 2000 Network

1. From the NMEA 2000 Sensor port menu, select NMEA 2000 Network.
2. Tap the on/off button, or press the ENTER key, to turn it on.

Select NMEA 2000 Devices Manually (optional)

When equipment is connected to the control head, the equipment and its data will be detected automatically. Use the instructions in this section to manually select devices to use on the NMEA 2000 network. See the illustrations on the following pages.

1. From the NMEA 2000 Sensor port menu, select NMEA 2000 Devices.
2. Select Auto-Select. Tap the on/off button, or press the ENTER key, to turn it off.
3. Select devices to add to the NMEA 2000 network. [check mark = included, blank = not included]

NMEA 2000 Network Devices Selected Manually

The screenshot shows the 'NMEA 2000 Devices' settings screen. The 'Auto-Select' toggle is turned off. The 'This Unit' is identified as SOLIX 15 SI - 161014220315. The following table lists the detected devices and their selection status:

| Device | Selection Status |
|--------|--------------------------|
| GH2183 | Selected (checked) |
| WSO100 | Selected (checked) |
| DST100 | Not Selected (unchecked) |
| TLM100 | Not Selected (unchecked) |

Annotations on the right side of the screen:

- Turn off Auto-Select (pointing to the 'OFF' toggle)
- selected device (pointing to the checked checkbox for GH2183)
- devices detected but not selected (pointing to the unchecked checkboxes for DST100 and TLM100)

NMEA 2000 Network Devices Selected Automatically

The screenshot shows the 'NMEA 2000 Devices' settings screen. The 'Auto-Select' toggle is turned on. The 'This Unit' is identified as SOLIX 15 SI - 161014220315. The following table lists the detected devices and their selection status:

| Device | Selection Status |
|--------|--------------------|
| GH2183 | Selected (checked) |
| WSO100 | Selected (checked) |
| DST100 | Selected (checked) |
| TLM100 | Selected (checked) |

Annotations on the right side of the screen:

- Turn on Auto-Select (pointing to the 'ON' toggle)
- devices detected and selected on the NMEA 2000 network (pointing to the checked checkboxes for GH2183, WSO100, DST100, and TLM100)

Set NMEA 2000 Data Offsets

1. From the NMEA 2000 Sensor port menu, select Data Offsets.
2. Select a device.
3. Tap the on/off slider, or press the ENTER key, to turn it off.
4. Press and hold the slider, or press and hold the ENTER key, to set the offset amount.

NMEA 2000 Data Offset

The screenshot displays the 'NMEA 2000 Data Offset' settings interface. On the left, a sidebar menu includes 'Settings', 'CHIRP Sonar', 'Chart', 'Navigation', 'Radar', 'General', 'My Vessel', 'Network' (highlighted), 'Simulation', and 'Restore Defaults'. The main content area is titled 'Data Offsets' and contains the instruction 'Assign data offsets for the individual NMEA 2000 sensors'. It lists four sensors: GH2183, WSO100, DST100, and TLM100. For the GH2183 sensor, three calibration settings are shown: 'Fuel Flow Calibration' at 3.9% with an 'ON' toggle, 'STW Calibration' at 0.0% with an 'OFF' toggle, and 'Heading Adjustment' at 0.0° with an 'OFF' toggle. A callout box points to the 'Heading Adjustment' toggle with the text: 'Turn off the slider to manually adjust the data offset.' Each setting includes a horizontal slider for manual adjustment.

NMEA 2000 Messages (PGN)

The following NMEA 2000 input/output messages are available when NMEA 2000 is turned on and the related NMEA 2000 equipment is detected and selected as a source.

| Message (PGN) | Description | Input | Output |
|---------------|---|-------|--------|
| 059392 | ISO Acknowledgement | ▪ | ▪ |
| 059904 | ISO Request | ▪ | ▪ |
| 060928 | ISO Address Claim | ▪ | ▪ |
| 126208 | NMEA - Command/Request/Acknowledge Function | ▪ | ▪ |
| 126464 | Receive/Transmit PGN List Group Function | ▪ | ▪ |
| 126992 | System Time | ▪ | |
| 126996 | Product Information | ▪ | ▪ |
| 127245 | Rudder | ▪ | |
| 127250 | Vessel Heading | ▪ | |
| 127251 | Rate of Turn | ▪ | |
| 127488 | Engine Parameters, Rapid Update | ▪ | |
| 127489 | Engine Parameters - Dynamic | ▪ | |
| 127497 | Trip Parameters, Engine | ▪ | |
| 127505 | Fluid Level | ▪ | |
| 128267 | Water Depth | ▪ | |
| 129026 | COG & SOG, Rapid Update | ▪ | |
| 129029 | GNSS Position Data | ▪ | |
| 129033 | Time & Date | ▪ | |
| 129283 | Cross Track Error | ▪ | |
| 129284 | Navigation Data | ▪ | |
| 129285 | Navigation - Route/WP Information | ▪ | |
| 129539 | GNSS DOPs | ▪ | |
| 129540 | GNSS Sats in View | ▪ | |
| 130052 | Loran C TD Data | ▪ | |
| 130306 | Wind Data | ▪ | |
| 130310 | Environmental Parameters | ▪ | |
| 130311 | Environmental Parameters | ▪ | |
| 130312 | Temperature | ▪ | |
| 130313 | Humidity | ▪ | |
| 130314 | Actual Pressure | ▪ | |
| 130576 | Small Craft Status | ▪ | |

NMEA 2000 AIS Messages (PGN)

The following NMEA 2000 input/output messages are available when NMEA 2000 is turned on and an AIS is detected and selected as a source on the NMEA 2000 network.

| Message (PGN) | Description | Input | Output |
|---------------|---------------------------------|-------|--------|
| 129038 | Class A Position Report | ▪ | |
| 129039 | Class B Position Report | ▪ | |
| 129809 | AIS Class B Static Data, Part A | ▪ | |
| 129810 | AIS Class B Static Data, Part B | ▪ | |

Set up NMEA 2000 Engine Sources

When a NMEA 2000 Engine is connected to the NMEA 2000 network, it is detected by the control head. The control head will provide prompts to set up engines in the system. The control head assigns a number to each engine. The sources are numbered lowest to highest, where 0 [zero] is the lowest and first source identified. You can use the sources identified by the control head, or you can manually assign an engine to each source number.

For example, Engine 1 reports data from the engine identified as the number 0 Instance in installation [typically the engine located on the port side of the boat towards the bow], and Engine 2 is the engine identified as the number 1 instance in installation [typically the engine located on the starboard side of the boat towards the keel].



NOTE: See **Views: Set up an Instrument View** to set up the instrument views for your engine data.

Set up the Number of Engines

The number of engines and tanks are entered using the Setup Guide during initial installation. Use the instructions in this section to change the number of engines and tanks displayed on the control head.

1. Press the HOME key.
2. Select Settings.
3. Select My Vessel.
4. Select Engines/Tanks.
5. Select the total number of engines and fuel tanks on your boat.

Engine 1 Source Auto-Configured

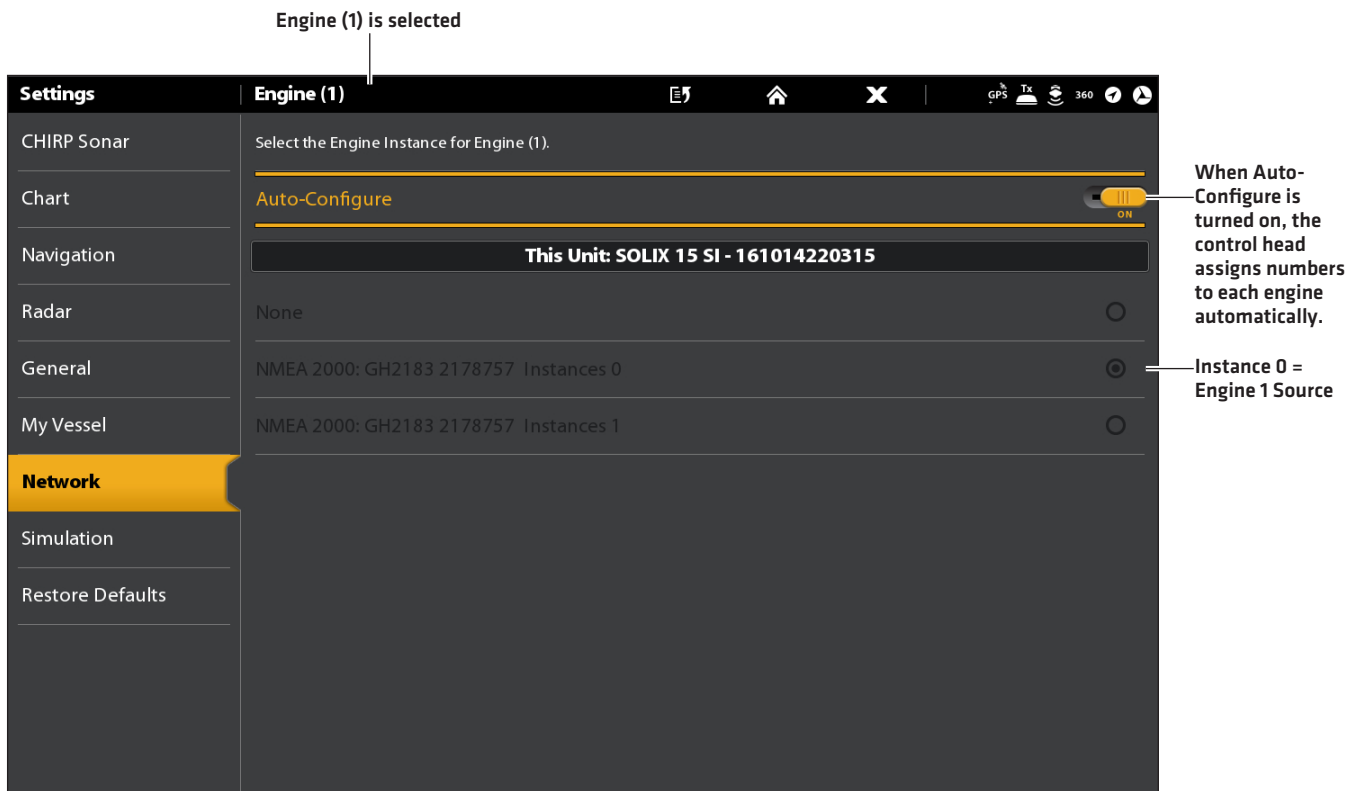

Change the Engine Source Assignments

The instructions in this section are optional and allow you to change which engine is assigned as the Engine 1, Engine 2, or Engine 3 source in the control head.

1. Press the HOME key.
2. Select Settings.
3. Select Network.
4. Select Data Sources.
5. Under Engine Data, select Engine 1, Engine 2, or Engine 3.
6. Turn off Auto-Configure.
7. Select an Engine from the list.

Set up Fuel Tanks

The Setup Guide provides prompts to set up the fuel tanks in the system, and it assigns a source number to each fuel tank. If a NMEA 2000 fuel tank sensor and a fuel flow rate sensor are installed, the control head can display fuel levels automatically. If only a fuel flow rate sensor is installed, you need to set up the fuel tanks manually to manage fuel levels.

Set up the Number of Tanks

The number of engines and tanks are entered using the Setup Guide during initial installation. Use the instructions in this section to change the number of engines and tanks displayed on the control head.

1. Press the HOME key.
2. Select Settings.
3. Select My Vessel.
4. Select Engines/Tanks.
5. Select the total number of engines and fuel tanks on your boat.

If you do not have a NMEA 2000 fuel tank sensor, proceed to **Set the Fuel Tank Capacity**.

Set the Fuel Tank Capacity

If there is a fuel flow rate sensor installed, but not a NMEA 2000 fuel tank sensor, use the instructions in this section to set up fuel tank data manually. You can also use these instructions to confirm Automatic Fuel Management Mode if you have a NMEA 2000 fuel tank sensor and a fuel flow rate sensor installed.

1. Set up the number of fuel tanks on the boat. See **Set up the Number of Tanks**.
2. Press the HOME key.
3. Select the Fuel tool.
4. Select Settings.
5. Select Manual.



NOTE: If NMEA 2000 fuel tank sensor and a fuel flow rate sensor are installed, select Auto to automatically detect the tank capacity.

6. Select Fuel Capacity.
7. Use the on-screen keyboard to enter the total fuel capacity of the tank.

If there is more than one tank on the boat, indicate the total amount of fuel from all tanks.

8. Select Save.

Setting up Fuel Tanks Manually

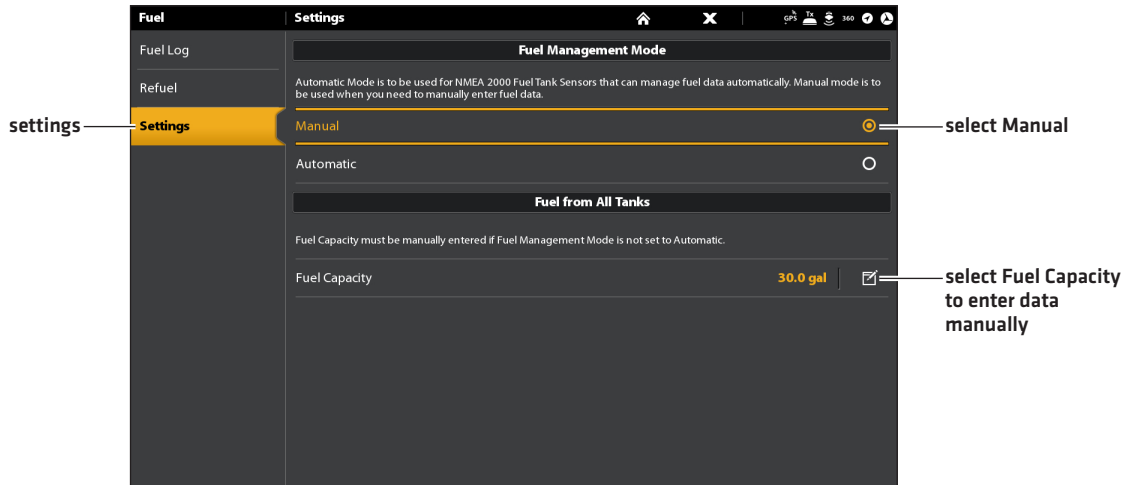

Displaying the Fuel Tool

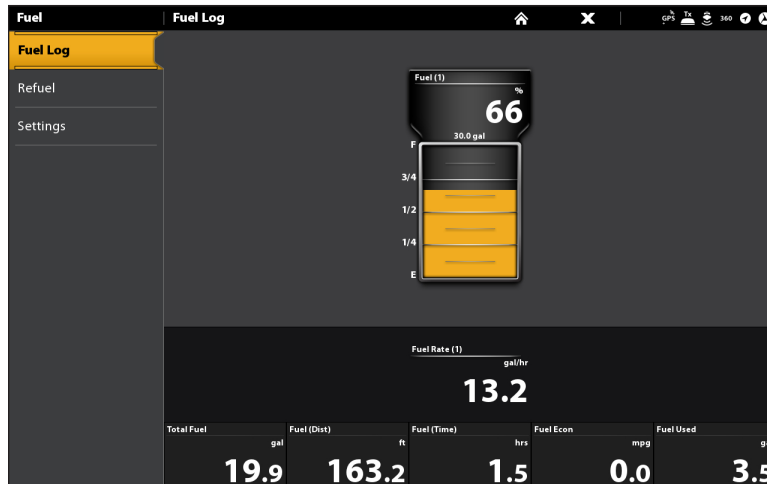

Open the Fuel Tool

1. Press the HOME key.
2. Select the Fuel tool.

Refill the Tank(s)

The menu options in this section are determined by the Fuel Management Mode [Manual or Automatic]. See *Set the Fuel Tank Capacity* for more information.

1. Open the Fuel tool, and select Refuel.
2. **To fill the tank to the top**, select Fill Up or Reset Fuel Used.

To add an amount to the tank, select Add Fuel. Use the on-screen keyboard to enter the amount and save it.

Change the Fuel Tank or Fuel Flow Source Assignments

The instructions in this section are optional and allow you to change which fuel tank is assigned as the Tank 1, Tank 2, or Tank 3 source in the control head. You can also use these instructions to change the fuel flow rate Sensors (Fuel Flow) assignments. The menu options are determined by the type of sensors installed.

1. Press the HOME key.
2. Select Settings.
3. Select Network.
4. Select Data Sources.
5. Under Fuel Data, select Tank 1, Tank 2, or Tank 3.
If fuel flow rate sensors are installed, select Fuel Flow - Engine 1, 2, or 3.
6. Turn off Auto-Configure.
7. Select a fuel tank from the list.

SET UP YOUR HUMMINBIRD NETWORK

When the Humminbird network is fully installed, configure the network so the control heads and equipment are synchronized across the network. Depending on your network configuration, your options may include sources from remote control head[s], NMEA 0183, Ethernet, and NMEA 2000.

Use the instructions in this section to complete the following network setup requirements:

1. Configure a new network.
2. Select transducers from the network.
3. Change GPS sources.
4. Select data sources.
5. Set vessel display settings.

Understand Global

When you configure a new network, the control heads are synchronized. Settings such as alarms, map sources, favorite views, preferences, overlays, sonar sources, and GPS sources are shared across control heads.

Many menu settings include the Global on/off button. **When Global is turned on**, the selected menu setting on the control head is shared with the other control heads in the network.

When Global is turned off, the selected menu setting is only available on the selected control head.

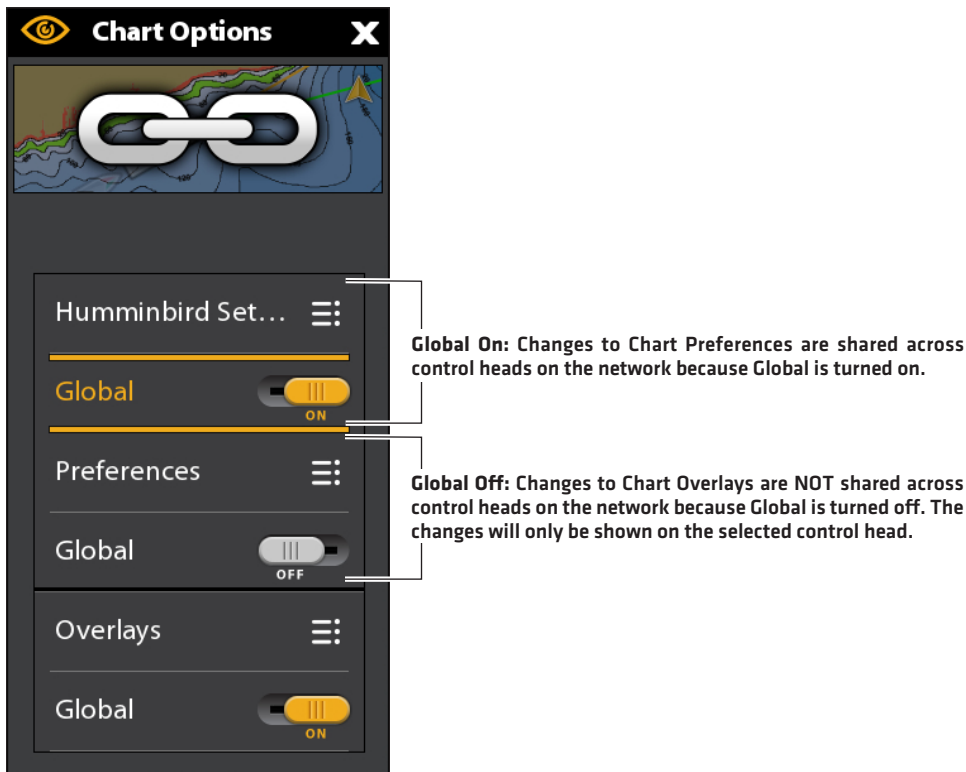

Understand Auto-Configure

When you configure the control head network, the control head automatically selects a source for each category. For example, if there are multiple heading sensors attached, the control head will choose one sensor to provide the heading. If you prefer a different sensor to provide the heading, you can manually select a different heading sensor.

The Auto-Configure on/off button is displayed in each source category. **When Auto-Configure is turned on**, the sources are selected automatically by the control head. **When Auto-Configure is turned off**, you can select sources based on your preferences.

1 | Configure a New Network

Use the instructions in this section if you have more than one Humminbird control head connected to the network. Configuring the network synchronizes the control head settings.

If there is only one control head on the network, skip this section. Proceed to section 2: *Select Sonar Sources*.

Preparation

1. Confirm all control heads and network equipment are powered on.
2. Designate one control head as the main control head. Ideally, you've used the main control head, and it has been set up with your favorite view settings, menu preferences, and more. The other control heads in the network will synchronize to the main control head.
If this is a first-time configuration for all control heads, no additional actions are required. Proceed to ***Configure the Network***.
3. **Global:** If there are any settings you'd like to keep on a control head, and not share globally, make sure the Global menu on that setting is turned off.
4. **Navigation data:** navigation data will be synchronized. To export navigation data from a control head and save it, export the data to an SD card. See ***Manage your Navigation Data***.
5. **Export Menu Settings:** When control heads are synchronized to a main unit, their menu settings are changed to match the main unit. To save menu settings from a selected remote control head, export the menu settings to an SD card [see ***Update Software***].

Configure the Network

1. On the main control head, press the HOME key.
2. Select Settings.
3. Select Network.
4. Select Configure New Network.
5. Select Sync Network.

2 | Select Sonar Sources

When a transducer is first connected to the control head or network (through black box sonar or additional Humminbird control heads), it will be detected by all control heads in the network. The APEX/SOLIX control head selects the transducer connected to it as the primary sonar source. The APEX/SOLIX control head is compatible with black box sonar to expand its sonar capabilities. See humminbird.com for transducer configuration options.



NOTE: Humminbird has provided the best setting for your unit. You can use the settings included with your control head, or you can adjust these advanced options.

Open the Sonar Source Menu

1. Press the HOME key.
2. Select Settings.
3. Select Sonar.
4. Select Sonar Source.

Sonar Source Overview

When the network is configured, you can select any transducer from the network to provide the sonar data on the control head. The sonar sources can be shared between control heads or you can use individual sonar sources on each control head.

The transducer you select on the 2D Sonar tab will provide the data for the 2D Sonar Views and related digital readouts.

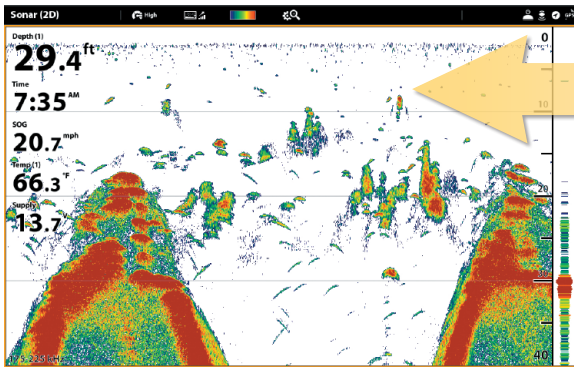

The Sonar Source Select menu is shown with '2D Sonar' selected. The menu includes options for 2D Sonar, Down Imaging, Side Imaging, and 360 Imaging. Each option has a radio button, a transducer icon, and associated settings for 2D Source, 2D Pinging, and Transducer Setting.

| Mode | 2D Source | 2D Pinging | Transducer Setting |
|--------------|--|-------------|--------------------|
| 2D Sonar | <input checked="" type="radio"/> SOLIX 12 SI | MED/HIGH ON | 2D + DI + SI ON |
| Down Imaging | <input type="radio"/> SOLIX 12 SI | MED/HIGH ON | 2D + DI + SI ON |
| Side Imaging | <input type="radio"/> SOLIX 12 SI | MED/HIGH ON | 2D + DI + SI ON |
| 360 Imaging | <input type="radio"/> 360 Imaging 150712227777 | 455/800 ON | ON |

The transducer you select on the Down Imaging tab will provide the data for the Down Imaging Views and related digital readouts.

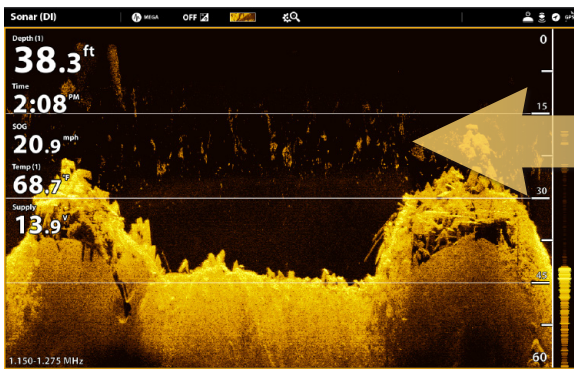

The Sonar Source Select menu is shown with 'Down Imaging' selected. The menu includes options for 2D Sonar, Down Imaging, Side Imaging, and 360 Imaging. Each option has a radio button, a transducer icon, and associated settings for DI Source, DI Pinging, and Transducer Setting.

| Mode | DI Source | DI Pinging | Transducer Setting |
|--------------|--|-----------------|--------------------|
| 2D Sonar | <input type="radio"/> SOLIX 12 SI | 455/800 ON | 2D + DI + SI ON |
| Down Imaging | <input checked="" type="radio"/> SOLIX 12 SI | 455/800/MEGA ON | 2D + DI + SI ON |
| Side Imaging | <input type="radio"/> SOLIX 12 SI | 455/800/MEGA ON | 2D + DI + SI ON |
| 360 Imaging | <input type="radio"/> 360 Imaging 150712227777 | 455/800 ON | ON |

The transducer you select on the Side Imaging tab will provide the data for the Side Imaging Views and related digital readouts.

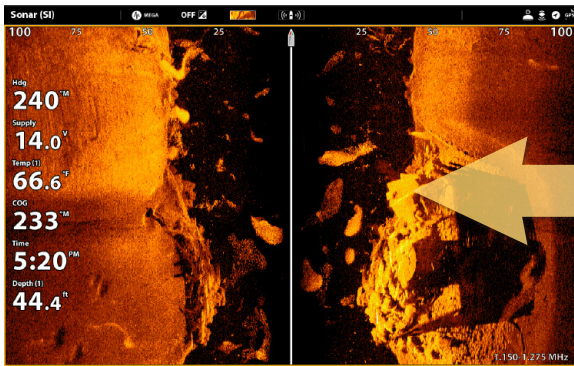

The Sonar Source Select menu is shown with 'Side Imaging' selected. The menu includes options for 2D Sonar, Down Imaging, Side Imaging, and 360 Imaging. Each option has a radio button, a transducer icon, and associated settings for SI Source, SI Pinging, and Transducer Setting.

| Mode | SI Source | SI Pinging | Transducer Setting |
|--------------|--|-----------------|--------------------|
| 2D Sonar | <input type="radio"/> SOLIX 12 SI | 455/800 ON | 2D + DI + SI ON |
| Down Imaging | <input type="radio"/> SOLIX 12 SI | 455/800 ON | 2D + DI + SI ON |
| Side Imaging | <input checked="" type="radio"/> SOLIX 12 SI | 455/800/MEGA ON | 2D + DI + SI ON |
| 360 Imaging | <input type="radio"/> 360 Imaging 150712227777 | 455/800 ON | ON |

Select Sonar Sources

Use the instructions in this section to assign sonar sources to each control head. The sonar sources can be shared between control heads or you can use different sonar sources on each control head.

1. From the Sonar Source Menu, select the first tab. In the following illustration, the first tab is 2D.

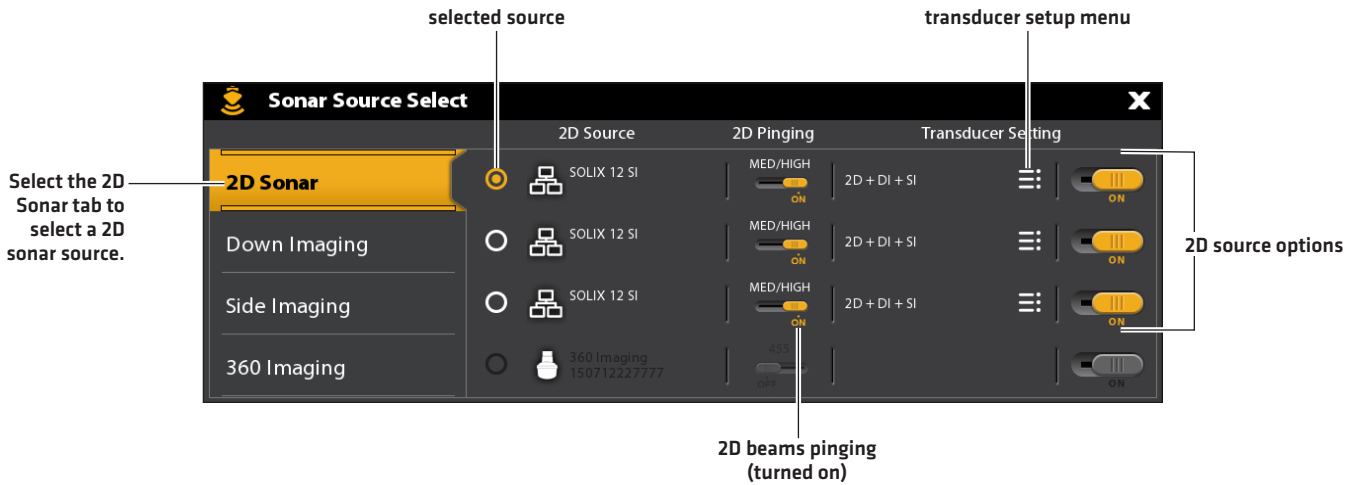

2. Select the transducer connection location. The connection locations are displayed as follows:



Selected Control Head [Local]: the control head you are actively using



Remote Control Head: additional control heads connected to the network



Black Box Sonar

3. Repeat steps 1 and 2 for each tab. You can select one sonar source on each tab.



NOTE: The list is determined by the connected equipment on the network and the transducer type. DualBeam PLUS sonar sources will only be displayed on the 2D tab, Down Imaging sources will only be displayed on the Down Imaging tab, etc.



NOTE: If you have installed an accessory transducer, and it is not displayed in the transducer list, see **Installation Information: Set up or Change Transducer Settings.**

When you turn on/off pinging or change the transducer settings, all control heads sharing the transducer are affected.

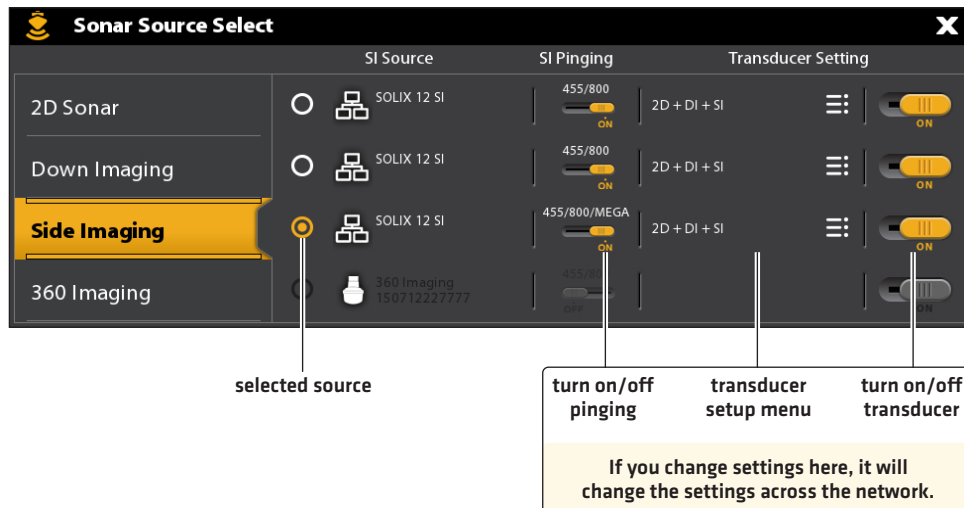

3 | Select GPS Sources [optional]

The APEX/SOLIX control head defaults to the internal GPS receiver as the primary source [GPS [1]]. If you connect an external GPS receiver to the control head, it will be assigned as the secondary source GPS [2].

If you connect an external GPS receiver to the control head, it will be assigned as the primary source GPS [1].

GPS [1] provides position data, Speed over Ground [SOG], Course over Ground [COG], waypoints, routes, tracks, and navigation calculations to the control head.

GPS [2] provides position data that is displayed in the GPS [2] data box.

You can also manually change which GPS receiver is the selected source for GPS [1] or GPS [2]. For example, if you've connected an external GPS receiver to the APEX/SOLIX control head, you can assign it to GPS [1], so the control head will use it as the primary source [instead of the internal GPS receiver]. If the control head is part of an Ethernet or NMEA 2000 network, you can also select the GPS receivers from the network.

Open the GPS Tool

1. Press the HOME key.
2. Select the GPS tool.

Select GPS Sources Automatically

1. Under GPS Source, select GPS [1] or GPS [2].
2. Select Auto-Configure. Tap the on/off button, or press the ENTER key, to turn it on.

Select GPS Sources Manually

Use the instructions in this section to manually select a GPS source.

1. Under GPS Source, select GPS [1] or GPS [2].
2. Select Auto-Configure. Tap the on/off button, or press the ENTER key, to turn it off.
3. Select a GPS receiver from the list.

Share GPS Sources with the Network

1. Under GPS Source, select Global Source.
2. Tap the on/off button, or press the ENTER key, to turn it on.



NOTE: See **Set up your Humminbird Network** for details about Global On/Off.

4 | Select Data Sources (optional)

When the network has been configured, you can choose sources from the entire network. Depending on your network configuration, your options may include sources from remote control head(s), NMEA 0183, Ethernet, and NMEA 2000. Sources are shared across the network. In some situations, sources can be individualized for each control head. For example, Control Head A can use one transducer and Control Head B can use a different transducer.

Auto-Configure: The Auto-Configure on/off button is displayed in each source category. When Auto-Configure is turned on, the sources are selected automatically by the control head. When Auto-Configure is turned off, you can select sources based on your preferences.

For example, if there are multiple heading sensors attached, the control head network will choose one sensor to provide the heading. If you prefer a different sensor to provide the heading, you can manually assign a different heading sensor as the selected source.

Select Sources Automatically (default)

Auto-Configure is turned on by default, so the instructions in this section are only necessary if you've manually changed the source selection and want to return to a source being chosen automatically.

1. Press the HOME key.
2. Select Settings.
3. Select Network.
4. Select Data Sources.
5. Select a Data Category, and select the data type under that category.
6. Select Auto-Configure. Tap the on/off button, or press the ENTER key, to turn it on.

Select Sources Manually (optional)

Use the instructions in this section to manually select a source.

1. Press the HOME key.
2. Select Settings.
3. Select Network.
4. Select Data Sources.
5. Select a Data Category, and select the data type under that category.
6. Select Auto-Configure. Tap the on/off button, or press the ENTER key, to turn it off.
7. Select a source from the list.

CHANGE THE NETWORK NAME

The Network Info menu allows you to name each network so it is easy to identify in the system. You can also review network information from the dialog box.

1. Press the HOME key.
2. Select Settings.
3. Select Network.
4. Select Network Info.
5. Select Rename Network. Use the on-screen keyboard to change the control head name.
6. Select Save.

Manually Selecting a Source for Temp [1]

Temp (1) is selected

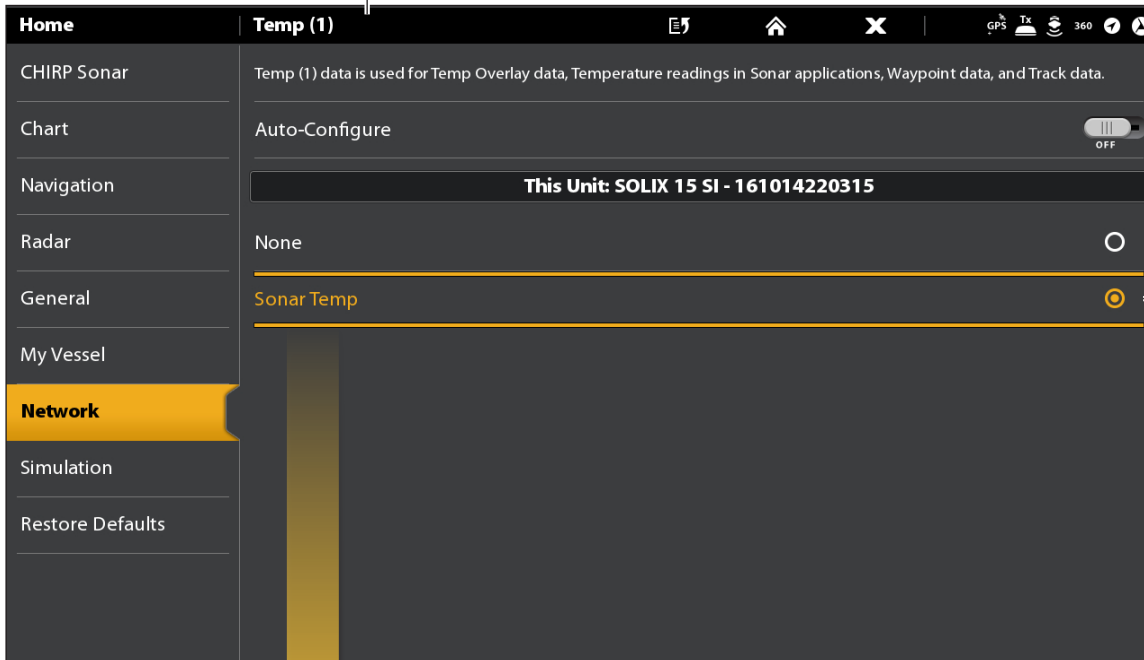

information about the selected source

When Auto-Configure is turned off, you can manually select a source.

selected source assigned to Temp (1)

The sources you select will provide the data for the related digital readouts and more, depending on your selection. In the illustration above, see *Information about the Selected Source*.

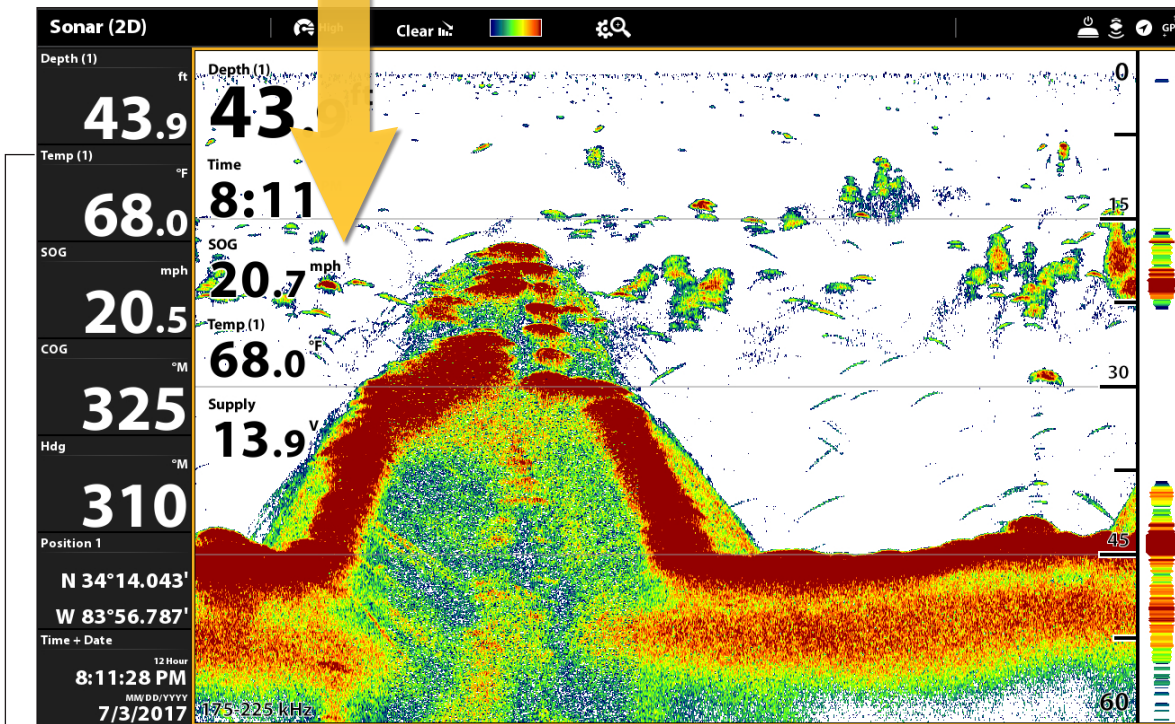

The Temp 1 digital readout data is provided by the Temp (1) source.

MANAGE YOUR CONTROL HEAD

Many of the control head settings can be accessed from the Settings tool [General Menu] or from the Power X-Press Menu in the status bar.

Open the Settings Tool

1. Press the HOME key.
2. Select Settings.
3. Select General.

Open the Power X-Press Menu

Many of the control head settings can be accessed quickly from the Power X-Press Menu. You can also turn off Radar transmission or change the transducer source from this menu.

1. Tap the top, right corner of the status bar.

OR

Press the POWER key.

Adjust Lighting

The lighting menus can be accessed from the Settings tool [General Menu] or the Power X-Press Menu. The following instructions use the Power X-Press Menu.

Adjust the Backlight

1. Open the Power X-Press Menu.
2. Select Backlight.
3. Press and hold the slider, or turn the Rotary dial, to adjust the setting.

Turn on/off Night Mode

1. Open the Power X-Press Menu.
2. Select Night Mode.
3. Tap the on/off button, or press the ENTER key.

Change Touch Screen and Key Sounds

Turn on/off Touch Screen

1. Press the POWER key twice.

OR

1. Open the Power X-Press Menu.
2. Select Touch Screen.
3. Tap the on/off button, or press the ENTER key.

Turn on/off Key Sounds

1. Press the HOME key.
2. Select Settings.
3. Select General.
4. Select Key Sounds.
5. Tap the on/off button, or press the ENTER key.

Import/Export Files

It is important to back up your data files periodically. Data files should also be saved to your PC before restoring the unit's defaults or updating software.



WARNING! Humminbird is not responsible for the loss of data files [waypoints, routes, tracks, groups, snapshots, recordings, etc.] that may occur due to direct or indirect damage to the unit's hardware or software. It is important to back up your control head's data files periodically. Data files should also be saved to your PC before restoring the unit's defaults or updating the software. Visit our Web site at humminbird.com for more information.

Use the following instructions to save your menu settings. To import or export navigation data, see *Manage your Navigation Data*. To export your Radar installation settings, see *Installation Information: Configure Humminbird Radar*.

Import Files

1. Install the SD card with the files into the control head port.
2. Press the HOME key.
3. Select the Files tool.
4. Under Import, select Menu Settings.
5. Follow the on-screen prompts to select a file and import it.

Export Files

1. Install the SD card with the files into the control head port.
2. Press the HOME key.
3. Select the Files tool.
4. Under Export, select Menu Settings.
5. Follow the on-screen prompts.
6. **Select a Save Location:** Select the port where the SD card is installed.

SPECIFICATIONS

The following sections contain the product specifications for the APEX and SOLIX control head and the [included] transducer. The sections are divided between APEX models and G1 [first generation], G2 [second generation] and G3 [third generation] SOLIX models.

For additional information about your product and/or transducers, visit our Web site at humminbird.com.

APEX MEGA SI+

Control Head

| | |
|---------------------------------|--|
| APEX 13 Display Size [diagonal] | 13.3 inches [337.82 mm] |
| APEX 16 Display Size [diagonal] | 15.6 inches [396.24 mm] |
| APEX 19 Display Size [diagonal] | 18.5 inches [469.9 mm] |
| Pixel Matrix | FHD 1920 x 1080 |
| Display Type | TFT Color |
| Backlight | LED |
| Communication | Bluetooth, NMEA 0183 Bus, NMEA 2000 Bus [LEN = 2], Dual Ethernet, WiFi |
| Power Requirement | 12 VDC |
| Current Draw | APEX 13: 3.3 Amps APEX 16: 4.4 Amps APEX 19: 4.5 Amps |
| Recommended Fuse | APEX 13: 5 Amps [slow blow or MDL equivalent] APEX 16: 7.5 Amps [slow blow or MDL equivalent] APEX 19: 7.5 Amps [slow blow or MDL equivalent] |
| IPX Rating | IPX7 Waterproof/Submersible @ 1 m for 30 minutes and dust tight |

Port 1: 2D, DI, SI, 360

CHIRP MEGA SI + Transducer [included]

XM 14 HW MSIT [includes built-in temperature probe]

| | |
|--------------------|--|
| Power Output [MAX] | 500 Watts [RMS], 4000 Watts [Peak to Peak] |
|--------------------|--|

MEGA Side Imaging+

| | |
|---------------------|---|
| Operating Frequency | 455 kHz, 800 kHz, MEGA Imaging+ |
| Range Capability | 455 kHz: 405 - 505 kHz, 800 ft [244 m] Side to Side 800 kHz: 780 - 840 kHz, 250 ft [76 m] Side to Side MEGA Imaging+: 1050 - 1175 kHz, 500 ft [152 m] Side to Side |
| Area of Coverage | 455 kHz: [2] 86° @ -10 dB [180° Total Coverage] 800 kHz: [2] 55° @ -10 dB [130° Total Coverage] MEGA Imaging+: [2] 86° @ -10 dB [180° Total Coverage] |

MEGA Down Imaging+

| | |
|---------------------------|---|
| Operating Frequency | 455 kHz, 800 kHz, MEGA Imaging+ |
| Depth Capability | 455 kHz: 435 - 535 kHz, 400 ft [122 m] 800 kHz: 800 - 860 kHz, 125 ft [38 m] MEGA Imaging+: 1100 - 1200 kHz, 250 ft [76 m] |
| Area of Coverage | 455 kHz: 75° @ -10 dB 800 kHz: 45° @ -10 dB MEGA Imaging+: 75° @ -10 dB |

2D CHIRP

| | |
|------------------------------------|--|
| Default Operating Frequency | Dual Spectrum CHIRP: 150 kHz - 220 kHz |
| Optional Operating Frequency | 200 kHz, 83 kHz, and 50 kHz High CHIRP, Medium CHIRP, Low CHIRP |
| Depth Capability | 1200 ft [365 m] |
| Area of Coverage | Full: 25° - 42°@-10 dB in 150 - 220 kHz Wide: 42°@-10 dB in 140 - 200 kHz Narrow: 25°@-10 dB in 180 - 240 kHz |
| Power Output [MAX] | 500 Watts [RMS], 4000 Watts [Peak to Peak] |

Port 2: 2kW 2D

2D CHIRP

| | |
|------------------------------------|--|
| Optional Operating Frequency | 200 kHz, 83 kHz, and 50 kHz High CHIRP, Medium CHIRP, Low CHIRP |
| Depth Capability | 1200 ft [365 m] / 5,000 ft [1,524 m]* |
| Power Output [MAX] | 2,000 Watts [RMS] |

*Optional Airmar CHIRP SM3000 required for extreme deep water use.



NOTE: Humminbird verifies maximum stated depth in saltwater conditions, but actual depth performance may vary due to transducer installation, water type, thermal layers, bottom composition, and slope.



NOTE: Product specifications and features are subject to change without notice.

APEX 13 Control Head Measurements

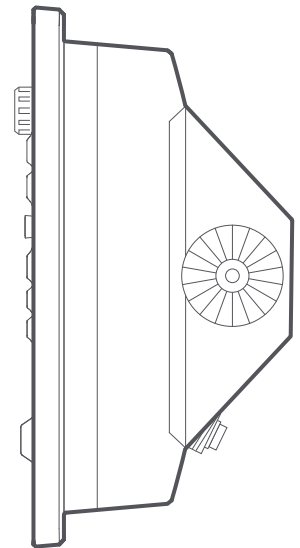
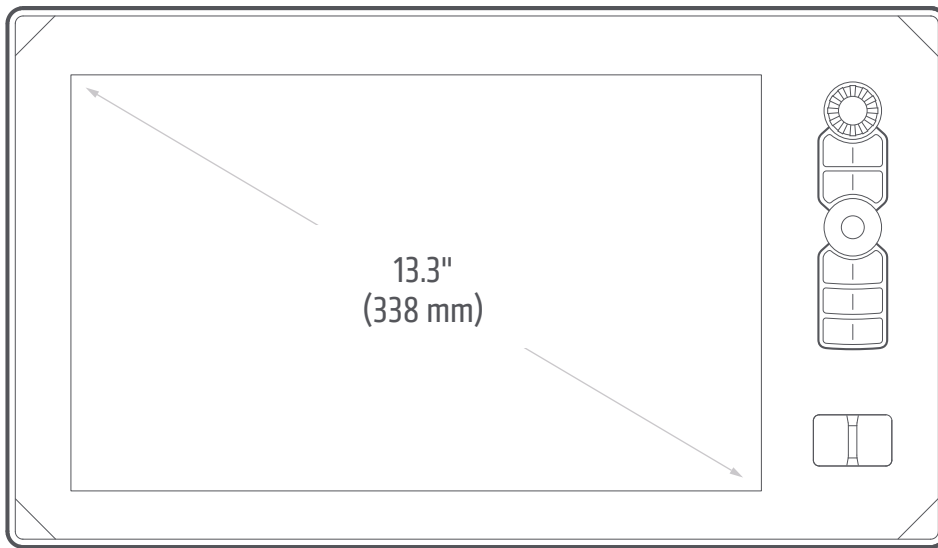

APEX 13 In-Dash Mount

| | |
|--------|----------------|
| Width | 15.6" [396 mm] |
| Height | 8.96" [227 mm] |
| Depth | 5.67" [144 mm] |

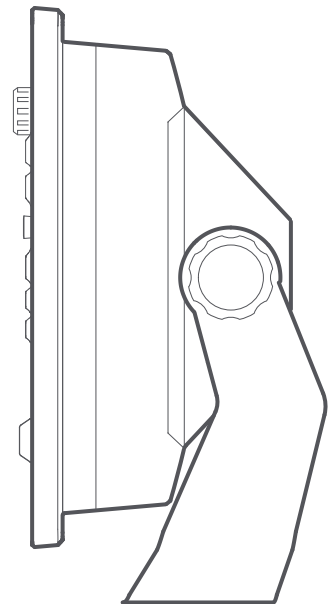
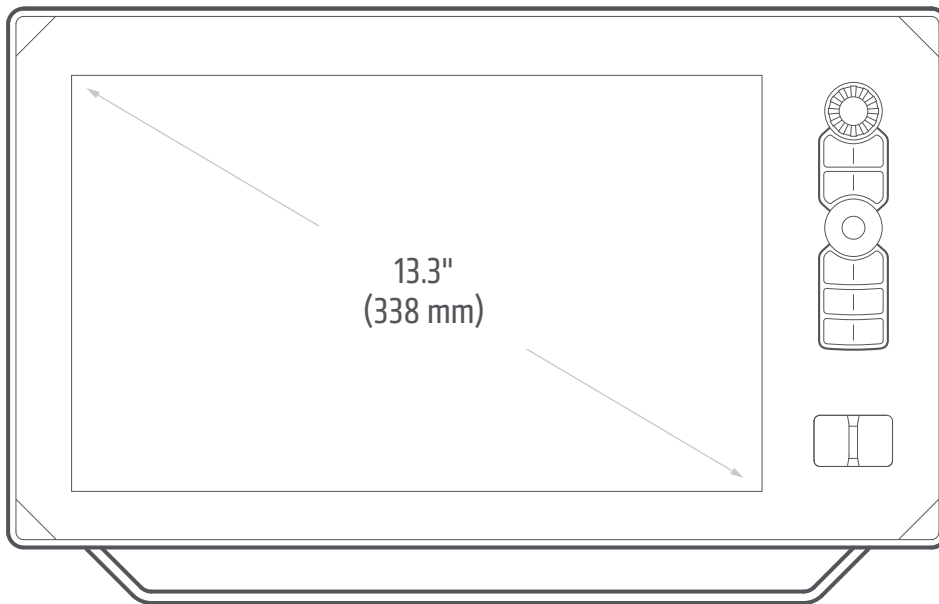

APEX 13 Gimbal Mount

| | |
|--------|----------------|
| Width | 15.6" [396 mm] |
| Height | 9.88" [251 mm] |
| Depth | 4.88" [124 mm] |

APEX 16 Control Head Measurements

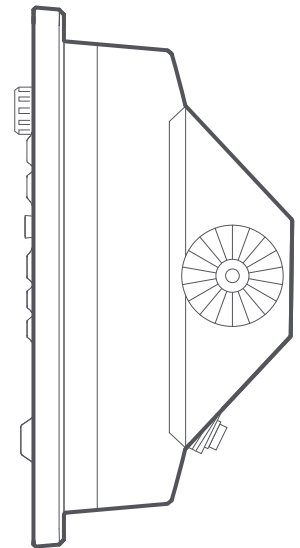
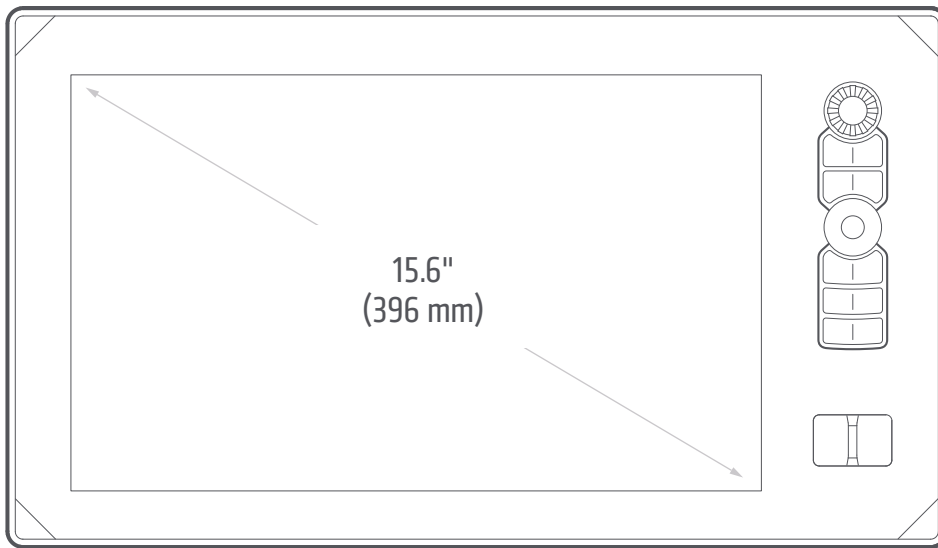

APEX 16 In-Dash Mount

| | |
|--------|-----------------|
| Width | 17.65" [448 mm] |
| Height | 10.13" [257 mm] |
| Depth | 5.48" [139 mm] |

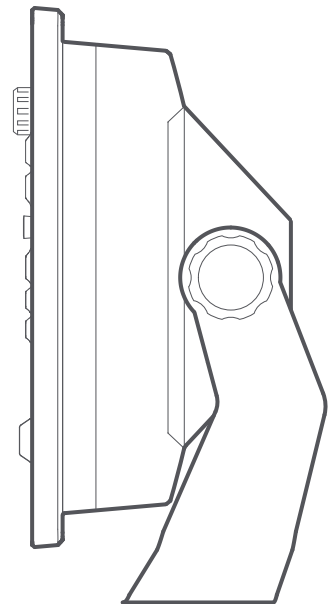
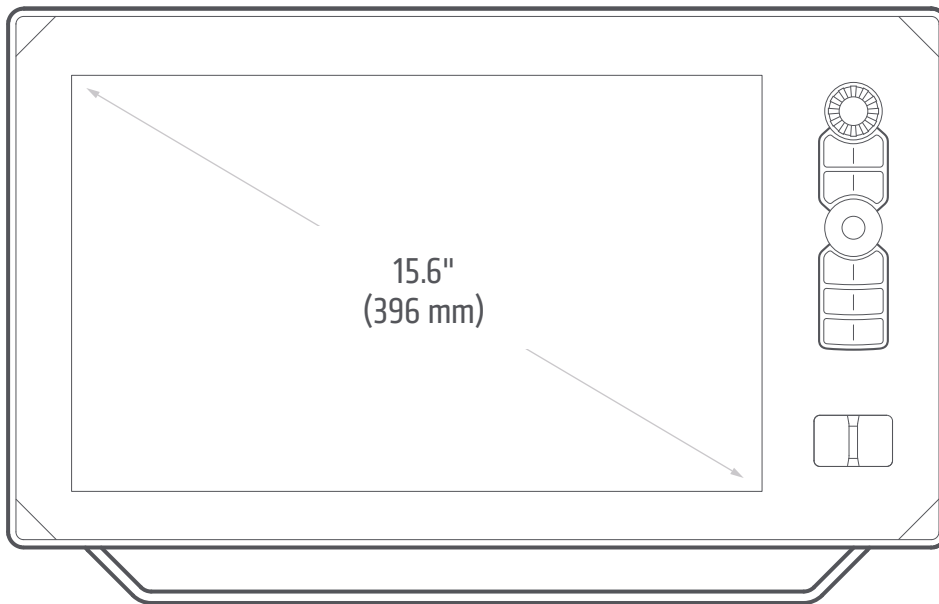

APEX 16 Gimbal Mount

| | |
|--------|-----------------|
| Width | 17.65" [448 mm] |
| Height | 11.05" [281 mm] |
| Depth | 4.93" [125 mm] |

APEX 19 Control Head Measurements

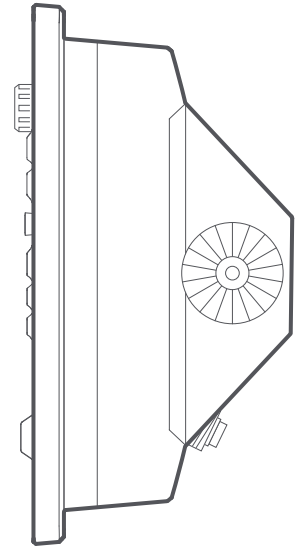
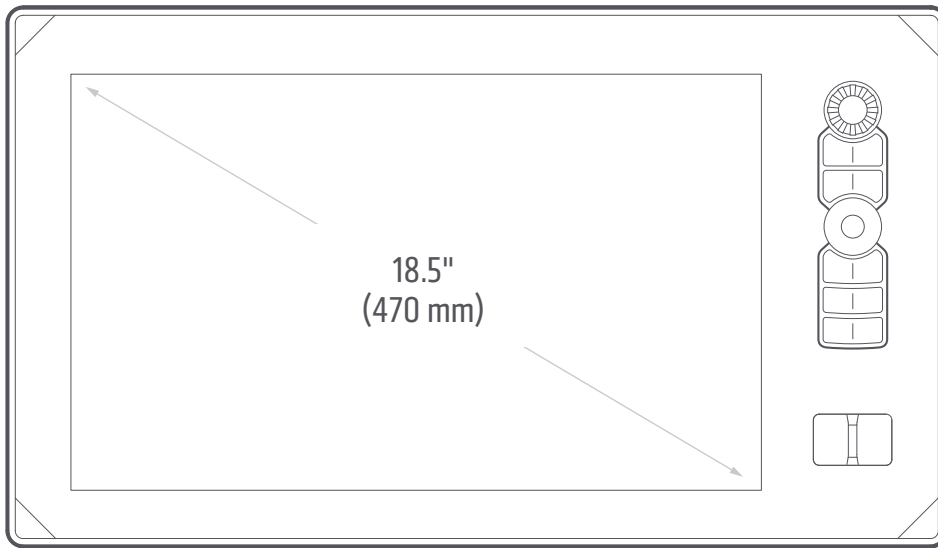

APEX 19 In-Dash Mount

| | |
|--------|-----------------|
| Width | 20.27" [515 mm] |
| Height | 11.66" [296 mm] |
| Depth | 5.33" [135 mm] |

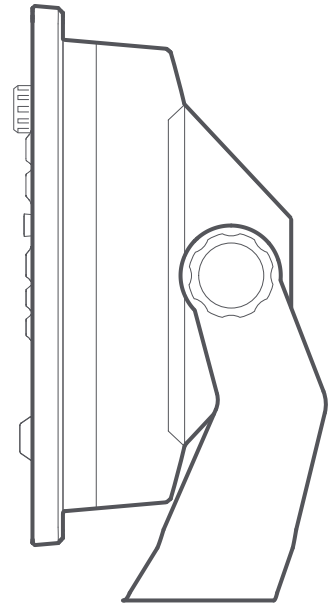
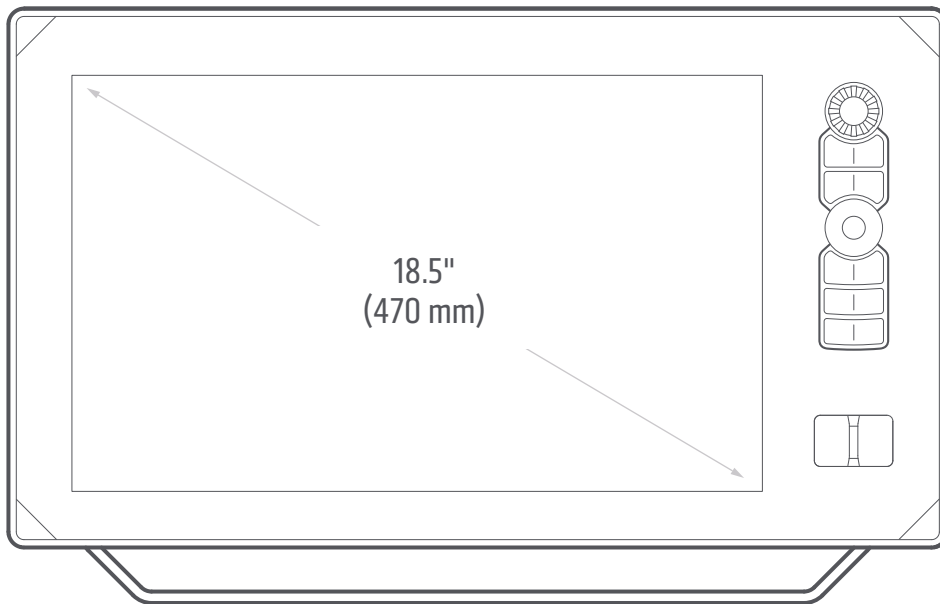

APEX 19 Gimbal Mount

| | |
|--------|-----------------|
| Width | 20.27" [515 mm] |
| Height | 12.58" [320 mm] |
| Depth | 4.95" [126 mm] |

Control Head

| | |
|---|---|
| SOLIX 10 Display Size [diagonal] | 10.1 inches [256.54 mm] |
| SOLIX 12 Display Size [diagonal] | 12.1 inches [307.3 mm] |
| SOLIX 15 Display Size [diagonal] | 15.4 inches [391.16 mm] |
| Pixel Matrix | WXGA 1280 x 800 |
| Display Type | TFT Color |
| Backlight | LED |
| Communication | Bluetooth, NMEA 0183 Bus, NMEA 2000 Bus [LEN = 2], Ethernet |
| Power Requirement | 12 VDC |
| Current Draw | SOLIX 10: 2.5 Amps SOLIX 12: 2.5 Amps SOLIX 15: 3.75 Amps |
| Recommended Fuse | SOLIX 10: 5 Amps [slow blow or MDL equivalent] SOLIX 12: 5 Amps [slow blow or MDL equivalent] SOLIX 15: 7.5 Amps [slow blow or MDL equivalent] |
| IPX Rating | IPX7 Waterproof/Submersible @ 1 m for 30 minutes |

CHIRP DualBeam PLUS Transducer

XNT 14 20 T [includes built-in temperature probe]

| | |
|---------------------------|---|
| Operating Frequency | 200 kHz and 83 kHz |
| Depth Capability | 1500 ft [457 m] |
| Area of Coverage | 60°@-10 dB in 83 kHz, 20°@-10 dB in 200 kHz |
| Power Output [MAX] | 500 Watts [RMS], 4000 Watts [Peak to Peak] |



NOTE: Humminbird verifies maximum stated depth in saltwater conditions, but actual depth performance may vary due to transducer installation, water type, thermal layers, bottom composition, and slope.



NOTE: Product specifications and features are subject to change without notice.

SOLIX SI G1

Control Head

| | |
|----------------------------------|---|
| SOLIX 10 Display Size [diagonal] | 10.1 inches [256.54 mm] |
| SOLIX 12 Display Size [diagonal] | 12.1 inches [307.3 mm] |
| SOLIX 15 Display Size [diagonal] | 15.4 inches [391.16 mm] |
| Pixel Matrix | WXGA 1280 x 800 |
| Display Type | TFT Color |
| Backlight | LED |
| Communication | Bluetooth, NMEA 0183 Bus, NMEA 2000 Bus [LEN = 2], Ethernet |
| Power Requirement | 12 VDC |
| Current Draw | SOLIX 10: 2.5 Amps SOLIX 12: 2.5 Amps SOLIX 15: 3.75 Amps |
| Recommended Fuse | SOLIX 10: 5 Amps [slow blow or MDL equivalent] SOLIX 12: 5 Amps [slow blow or MDL equivalent] SOLIX 15: 7.5 Amps [slow blow or MDL equivalent] |
| IPX Rating | IPX7 Waterproof/Submersible @ 1 m for 30 minutes and dust tight |

CHIRP MEGA Side Imaging Transducer

XM 14 20 MSI T [includes built-in temperature probe]

| | |
|--------------------|--|
| Power Output [MAX] | 500 Watts [RMS], 4000 Watts [Peak to Peak] |
|--------------------|--|

Side Imaging

| | |
|---------------------|---|
| Operating Frequency | 455 kHz, 800 kHz, MEGA |
| Range Capability | 455 kHz: 800 ft [244 m] Side to Side 800 kHz: 250 ft [76 m] Side to Side MEGA: 250 ft [76 m] Side to Side |
| Area of Coverage | 455 kHz: [2] 86° @ -10 dB [180° Total Coverage] 800 kHz: [2] 55° @ -10 dB [130° Total Coverage] MEGA: [2] 86° @ -10 dB [180° Total Coverage] |

Down Imaging

| | |
|---------------------|---|
| Operating Frequency | 455 kHz, 800 kHz, MEGA |
| Depth Capability | 455 kHz: 800 ft [122 m] 800 kHz: 150 ft [45.7 m] MEGA: 125 ft [38 m] |
| Area of Coverage | 455 kHz: 75° @ -10 dB 800 kHz: 45° @ -10 dB MEGA: 75° @ -10 dB |

DualBeam PLUS

| | |
|---------------------------|---|
| Operating Frequency | 200 kHz and 83 kHz |
| Depth Capability | 1500 ft (457 m) |
| Area of Coverage | 60°@-10 dB in 83 kHz 20°@-10 dB in 200 kHz |
| Power Output [MAX] | 500 Watts [RMS], 4000 Watts [Peak to Peak] |



NOTE: Humminbird verifies maximum stated depth in saltwater conditions, but actual depth performance may vary due to transducer installation, water type, thermal layers, bottom composition, and slope.



NOTE: Product specifications and features are subject to change without notice.

SOLIX DI G1

Control Head

| | |
|---|---|
| SOLIX 10 Display Size [diagonal] | 10.1 inches [256.54 mm] |
| SOLIX 12 Display Size [diagonal] | 12.1 inches [307.3 mm] |
| SOLIX 15 Display Size [diagonal] | 15.4 inches [391.16 mm] |
| Pixel Matrix | WXGA 1280 x 800 |
| Display Type | TFT Color |
| Backlight | LED |
| Communication | Bluetooth, NMEA 0183 Bus, NMEA 2000 Bus [LEN = 2], Ethernet |
| Power Requirement | 12 VDC |
| Current Draw | SOLIX 10: 2.5 Amps SOLIX 12: 2.5 Amps SOLIX 15: 3.75 Amps |
| Recommended Fuse | SOLIX 10: 5 Amps [slow blow or MDL equivalent] SOLIX 12: 5 Amps [slow blow or MDL equivalent] SOLIX 15: 7.5 Amps [slow blow or MDL equivalent] |
| IPX Rating | IPX7 Waterproof/Submersible @ 1 m for 30 minutes and dust tight |

CHIRP MEGA Down Imaging Transducer

XM 9 MDI T [includes built-in temperature probe]

Down Imaging

| | |
|---------------------------|---|
| Operating Frequency | 455 kHz, 800 kHz, MEGA |
| Depth Capability | 455 kHz: 800 ft [122 m] 800 kHz: 150 ft [45.7 m] MEGA: 125 ft [38 m] |
| Area of Coverage | 455 kHz: 75° @ -10 dB 800 kHz: 45° @ -10 dB MEGA: 75° @ -10 dB |
| Power Output [MAX] | 500 Watts [RMS], 4000 Watts [Peak to Peak] |

2D Sonar

| | |
|---------------------------|--|
| Operating Frequency | 200 kHz |
| Depth Capability | 1200 ft (366 m) |
| Area of Coverage | 20°@-10 dB in 200 kHz |
| Power Output [MAX] | 500 Watts [RMS], 4000 Watts [Peak to Peak] |



NOTE: Humminbird verifies maximum stated depth in saltwater conditions, but actual depth performance may vary due to transducer installation, water type, thermal layers, bottom composition, and slope.



NOTE: Product specifications and features are subject to change without notice.

Control Head

| | |
|---|---|
| SOLIX 10 Display Size [diagonal] | 10.1 inches [256.54 mm] |
| SOLIX 12 Display Size [diagonal] | 12.1 inches [307.3 mm] |
| SOLIX 15 Display Size [diagonal] | 15.4 inches [391.16 mm] |
| Pixel Matrix | WXGA 1280 x 800 |
| Display Type | TFT Color |
| Backlight | LED |
| Communication | Bluetooth, NMEA 0183 Bus, NMEA 2000 Bus [LEN = 2], Ethernet, WiFi |
| Power Requirement | 12 VDC |
| Current Draw | SOLIX 10: 2.5 Amps SOLIX 12: 2.5 Amps SOLIX 15: 3.75 Amps |
| Recommended Fuse | SOLIX 10: 5 Amps [slow blow or MDL equivalent] SOLIX 12: 5 Amps [slow blow or MDL equivalent] SOLIX 15: 7.5 Amps [slow blow or MDL equivalent] |
| IPX Rating | IPX7 Waterproof/Submersible @ 1 m for 30 minutes and dust tight |

CHIRP MEGA SI + Transducer [included]**XM 14 HW MSI T** [includes built-in temperature probe]

| | |
|--------------------------|--|
| Power Output [MAX] | 500 Watts [RMS], 4000 Watts [Peak to Peak] |
|--------------------------|--|

MEGA Side Imaging+

| | |
|---------------------------|---|
| Operating Frequency | 455 kHz, 800 kHz, MEGA Imaging+ |
| Range Capability | 455 kHz: 404 - 505 kHz, 800 ft [244 m] Side to Side 800 kHz: 780 - 840 kHz, 250 ft [76 m] Side to Side MEGA Imaging+: 1050 - 1175 kHz, 500 ft [152 m] Side to Side |
| Area of Coverage | 455 kHz: [2] 86° @ -10 dB [180° Total Coverage] 800 kHz: [2] 55° @ -10 dB [130° Total Coverage] MEGA Imaging+: [2] 86° @ -10 dB [180° Total Coverage] |

MEGA Down Imaging+

| | |
|---------------------------|---|
| Operating Frequency | 455 kHz, 800 kHz, MEGA Imaging+ |
| Depth Capability | 455 kHz: 435 - 535 kHz, 400 ft [122 m] 800 kHz: 800 - 860 kHz, 125 ft [38 m] MEGA Imaging+: 1100 - 1200 kHz, 250 ft [76 m] |
| Area of Coverage | 455 kHz: 75° @ -10 dB 800 kHz: 45° @ -10 dB MEGA Imaging+: 75° @ -10 dB |

Dual Spectrum CHIRP

| | |
|-----------------------------------|--|
| Default Operating Frequency | 150 kHz - 220 kHz |
| Depth Capability | 1200 ft (366 m) |
| Area of Coverage | Full: 25° - 42°@-10 dB in 150 - 220 kHz Wide: 42°@-10 dB in 140 - 200 kHz Narrow: 25°@-10 dB in 180 - 240 kHz |
| Power Output [MAX] | 500 Watts [RMS], 4000 Watts [Peak to Peak] |



NOTE: Humminbird verifies maximum stated depth in saltwater conditions, but actual depth performance may vary due to transducer installation, water type, thermal layers, bottom composition, and slope.



NOTE: Product specifications and features are subject to change without notice.

Control Head

| | |
|---|---|
| SOLIX 10 Display Size [diagonal] | 10.1 inches [256.54 mm] |
| SOLIX 12 Display Size [diagonal] | 12.1 inches [307.3 mm] |
| SOLIX 15 Display Size [diagonal] | 15.4 inches [391.16 mm] |
| Pixel Matrix | WXGA 1280 x 800 |
| Display Type | TFT Color |
| Backlight | LED |
| Communication | Bluetooth, NMEA 0183 Bus, NMEA 2000 Bus [LEN = 2], Ethernet, WiFi |
| Power Requirement | 12 VDC |
| Current Draw | SOLIX 10: 2.5 Amps SOLIX 12: 2.5 Amps SOLIX 15: 3.75 Amps |
| Recommended Fuse | SOLIX 10: 5 Amps [slow blow or MDL equivalent] SOLIX 12: 5 Amps [slow blow or MDL equivalent] SOLIX 15: 7.5 Amps [slow blow or MDL equivalent] |
| IPX Rating | IPX7 Waterproof/Submersible @ 1 m for 30 minutes and dust tight |

CHIRP MEGA Down Imaging+ Transducer [not included]

XM 14 HW MDI T [includes built-in temperature probe]

Down Imaging

| | |
|---------------------------|--|
| Operating Frequency | 455 kHz, 800 kHz, MEGA Imaging+ |
| Depth Capability | 455 kHz: 800 ft [122 m] 800 kHz: 150 ft [45.7 m] MEGA Imaging+: 250 ft [76 m] |
| Area of Coverage | 455 kHz: 75° @ -10 dB 800 kHz: 45° @ -10 dB MEGA Imaging+: 75° @ -10 dB |
| Power Output [MAX] | 500 Watts [RMS], 4000 Watts [Peak to Peak] |

2D Sonar

| | |
|---------------------------|--|
| Operating Frequency | 200 kHz |
| Depth Capability | 1200 ft (366 m) |
| Area of Coverage | 20°@-10 dB in 200 kHz |
| Power Output [MAX] | 500 Watts [RMS], 4000 Watts [Peak to Peak] |



NOTE: Humminbird verifies maximum stated depth in saltwater conditions, but actual depth performance may vary due to transducer installation, water type, thermal layers, bottom composition, and slope.



NOTE: Product specifications and features are subject to change without notice.

Control Head

| | |
|---|---|
| SOLIX 10 Display Size [diagonal] | 10.1 inches [256.54 mm] |
| SOLIX 12 Display Size [diagonal] | 12.1 inches [307.3 mm] |
| SOLIX 15 Display Size [diagonal] | 15.4 inches [391.16 mm] |
| Pixel Matrix | WXGA 1280 x 800 |
| Display Type | TFT Color |
| Backlight | LED |
| Communication | Bluetooth, NMEA 0183 Bus, NMEA 2000 Bus [LEN = 2], Ethernet, WiFi |
| Power Requirement | 12 VDC |
| Current Draw | SOLIX 10: 2.4 Amps SOLIX 12: 2.9 Amps SOLIX 15: 4 Amps |
| Recommended Fuse | SOLIX 10: 5 Amps [slow blow or MDL equivalent] SOLIX 12: 5 Amps [slow blow or MDL equivalent] SOLIX 15: 7.5 Amps [slow blow or MDL equivalent] |
| IPX Rating | IPX7 Waterproof/Submersible @ 1 m for 30 minutes and dust tight |

CHIRP MEGA SI + Transducer [included]**XM 14 HW MSI T** [includes built-in temperature probe]

| | |
|--------------------|--|
| Power Output [MAX] | 500 Watts [RMS], 4000 Watts [Peak to Peak] |
|--------------------|--|

MEGA Side Imaging+

| | |
|---------------------|---|
| Operating Frequency | 455 kHz, 800 kHz, MEGA Imaging+ |
| Range Capability | 455 kHz: 404 - 505 kHz, 800 ft [244 m] Side to Side 800 kHz: 780 - 840 kHz, 250 ft [76 m] Side to Side MEGA Imaging+: 1050 - 1175 kHz, 500 ft [152 m] Side to Side |
| Area of Coverage | 455 kHz: [2] 86° @ -10 dB [180° Total Coverage] 800 kHz: [2] 55° @ -10 dB [130° Total Coverage] MEGA Imaging+: [2] 86° @ -10 dB [180° Total Coverage] |

MEGA Down Imaging+

| | |
|---------------------|---|
| Operating Frequency | 455 kHz, 800 kHz, MEGA Imaging+ |
| Depth Capability | 455 kHz: 435 - 535 kHz, 400 ft [122 m] 800 kHz: 800 - 860 kHz, 125 ft [38 m] MEGA Imaging+: 1100 - 1200 kHz, 250 ft [76 m] |
| Area of Coverage | 455 kHz: 75° @ -10 dB 800 kHz: 45° @ -10 dB MEGA Imaging+: 75° @ -10 dB |

Dual Spectrum CHIRP

| | |
|-----------------------------------|--|
| Default Operating Frequency | 150 kHz - 220 kHz |
| Depth Capability | 1200 ft (366 m) |
| Area of Coverage | Full: 25° - 42°@-10 dB in 150 - 220 kHz Wide: 42°@-10 dB in 140 - 200 kHz Narrow: 25°@-10 dB in 180 - 240 kHz |
| Power Output [MAX] | 500 Watts [RMS], 4000 Watts [Peak to Peak] |



NOTE: Humminbird verifies maximum stated depth in saltwater conditions, but actual depth performance may vary due to transducer installation, water type, thermal layers, bottom composition, and slope.



NOTE: Product specifications and features are subject to change without notice.

Control Head

| | |
|---|---|
| SOLIX 10 Display Size [diagonal] | 10.1 inches [256.54 mm] |
| SOLIX 12 Display Size [diagonal] | 12.1 inches [307.3 mm] |
| SOLIX 15 Display Size [diagonal] | 15.4 inches [391.16 mm] |
| Pixel Matrix | WXGA 1280 x 800 |
| Display Type | TFT Color |
| Backlight | LED |
| Communication | Bluetooth, NMEA 0183 Bus, NMEA 2000 Bus [LEN = 2], Ethernet, WiFi |
| Power Requirement | 12 VDC |
| Current Draw | SOLIX 10: 2.4 Amps SOLIX 12: 2.9 Amps SOLIX 15: 4 Amps |
| Recommended Fuse | SOLIX 10: 5 Amps [slow blow or MDL equivalent] SOLIX 12: 5 Amps [slow blow or MDL equivalent] SOLIX 15: 7.5 Amps [slow blow or MDL equivalent] |
| IPX Rating | IPX7 Waterproof/Submersible @ 1 m for 30 minutes and dust tight |

CHIRP MEGA Down Imaging+ Transducer [not included]

XM 14 HW MDI T [includes built-in temperature probe]

Down Imaging

| | |
|---------------------------|--|
| Operating Frequency | 455 kHz, 800 kHz, MEGA Imaging+ |
| Depth Capability | 455 kHz: 800 ft [122 m] 800 kHz: 150 ft [45.7 m] MEGA Imaging+: 250 ft [76 m] |
| Area of Coverage | 455 kHz: 75° @ -10 dB 800 kHz: 45° @ -10 dB MEGA Imaging+: 75° @ -10 dB |
| Power Output [MAX] | 500 Watts [RMS], 4000 Watts [Peak to Peak] |

2D Sonar

| | |
|---------------------------|--|
| Operating Frequency | 200 kHz |
| Depth Capability | 1200 ft (366 m) |
| Area of Coverage | 20°@-10 dB in 200 kHz |
| Power Output [MAX] | 500 Watts [RMS], 4000 Watts [Peak to Peak] |



NOTE: Humminbird verifies maximum stated depth in saltwater conditions, but actual depth performance may vary due to transducer installation, water type, thermal layers, bottom composition, and slope.



NOTE: Product specifications and features are subject to change without notice.

SOLIX 10 Control Head Measurements

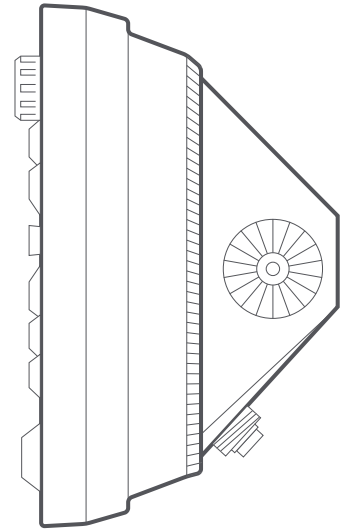
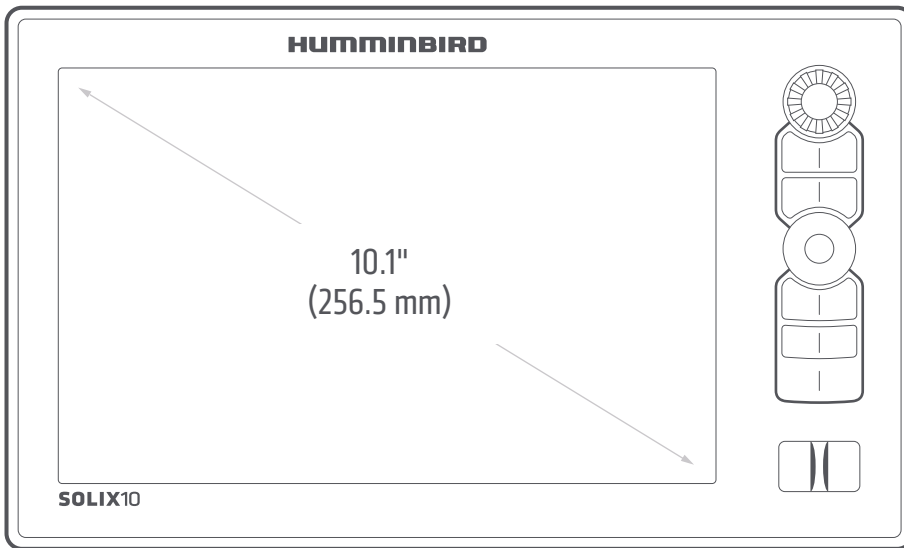

SOLIX 10 In-Dash Mount (separate purchase required)

| | |
|--------|------------------|
| Width | 11.8" [299.7 mm] |
| Height | 7.1" [179.3 mm] |
| Depth | 1.2" [30.5 mm] |

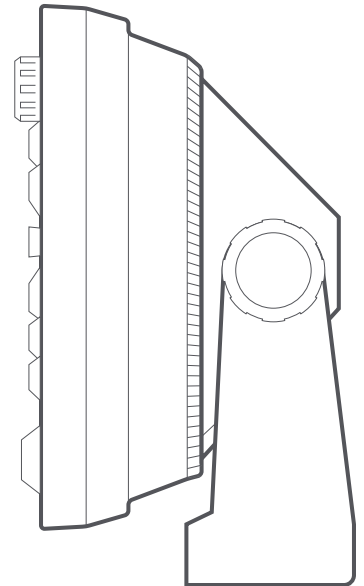
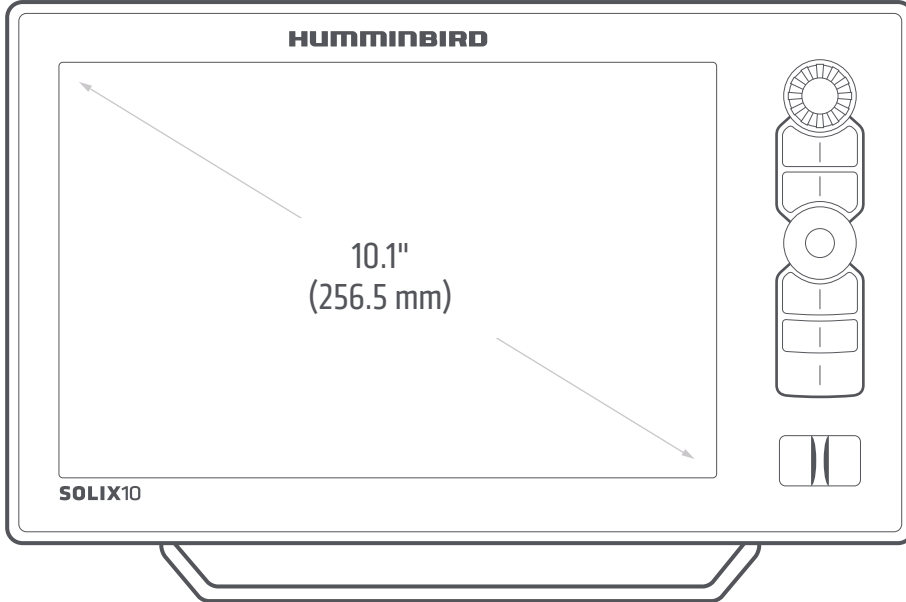

SOLIX 10 Gimbal Mount

| | |
|--------|------------------|
| Width | 11.8" [299.7 mm] |
| Height | 7.9" [200.4 mm] |
| Depth | 4.8" [122 mm] |

SOLIX 12 Control Head Measurements

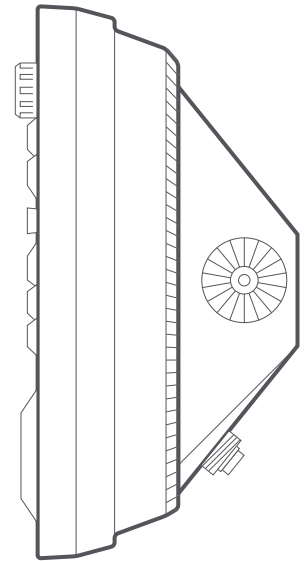
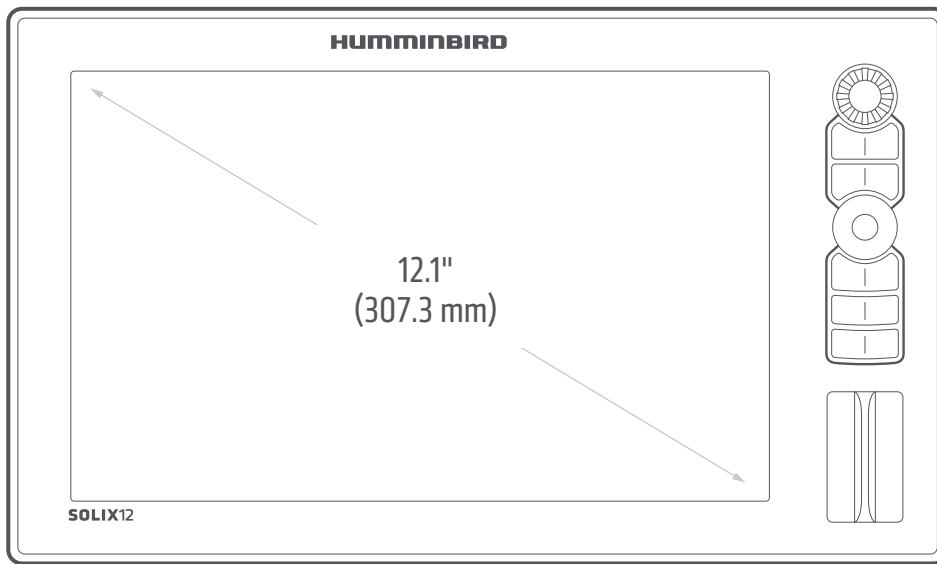

SOLIX 12 In-Dash Mount (separate purchase required)

| | |
|--------|------------------|
| Width | 13.8" [350.5 mm] |
| Height | 8.2" [208.5 mm] |
| Depth | 1.2" [30.5 mm] |

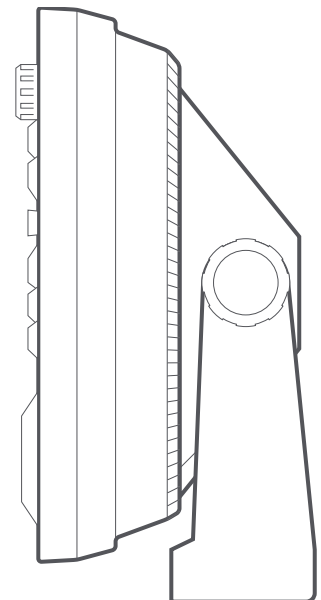
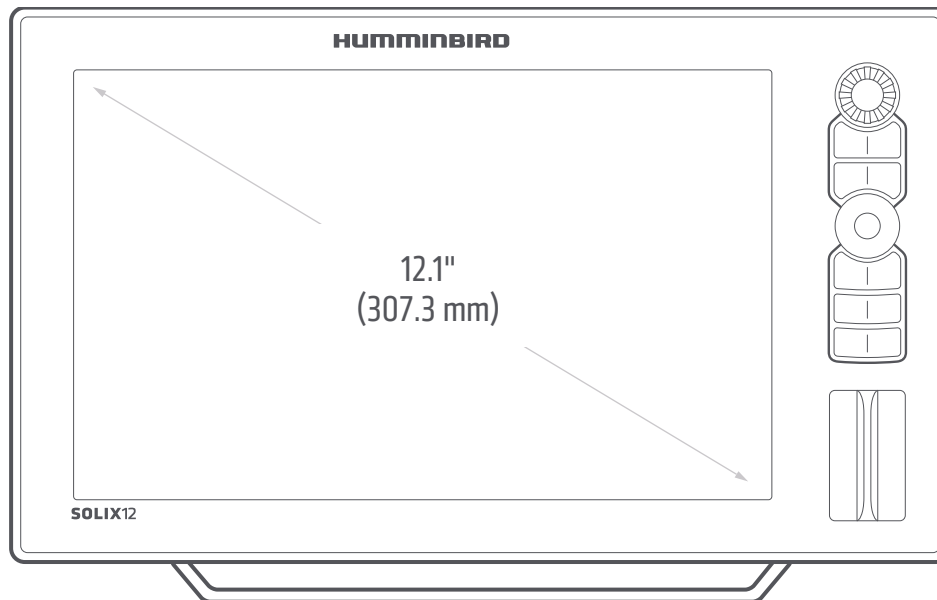

SOLIX 12 Gimbal Mount

| | |
|--------|------------------|
| Width | 13.8" [350.5 mm] |
| Height | 8.7" [221 mm] |
| Depth | 4.8" [122 mm] |

SOLIX 15 Control Head Measurements

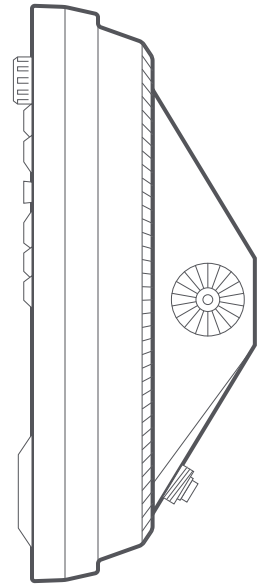
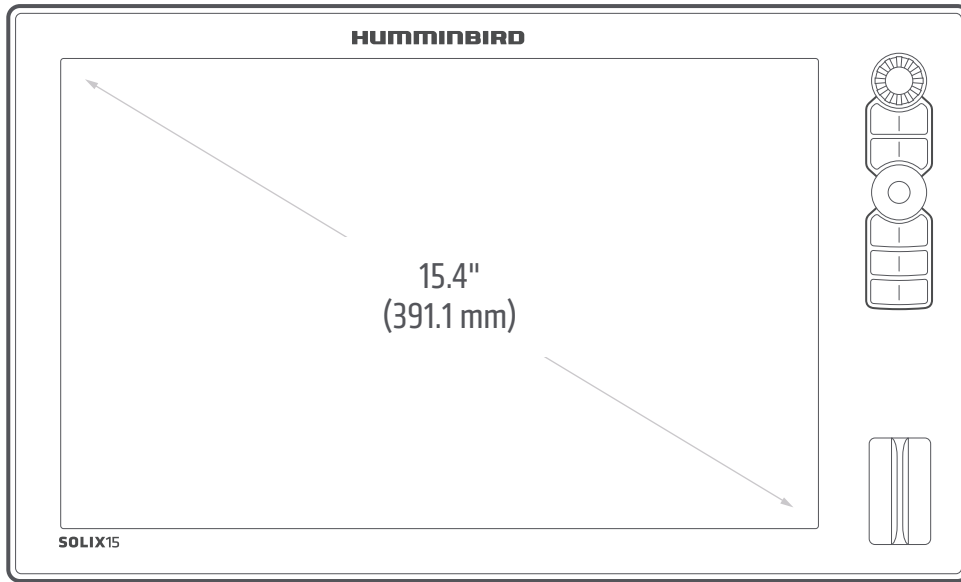

SOLIX 15 In-Dash Mount (separate purchase required)

| | |
|--------|------------------|
| Width | 16.5" [419.9 mm] |
| Height | 10.1" [256.5 mm] |
| Depth | 1.2" [30.5 mm] |

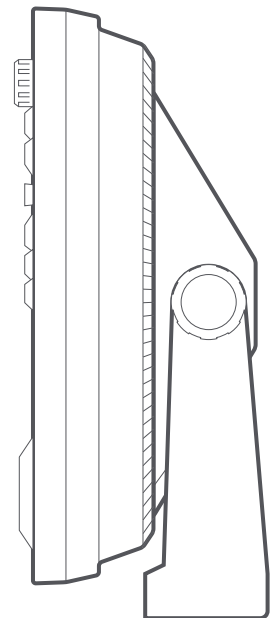
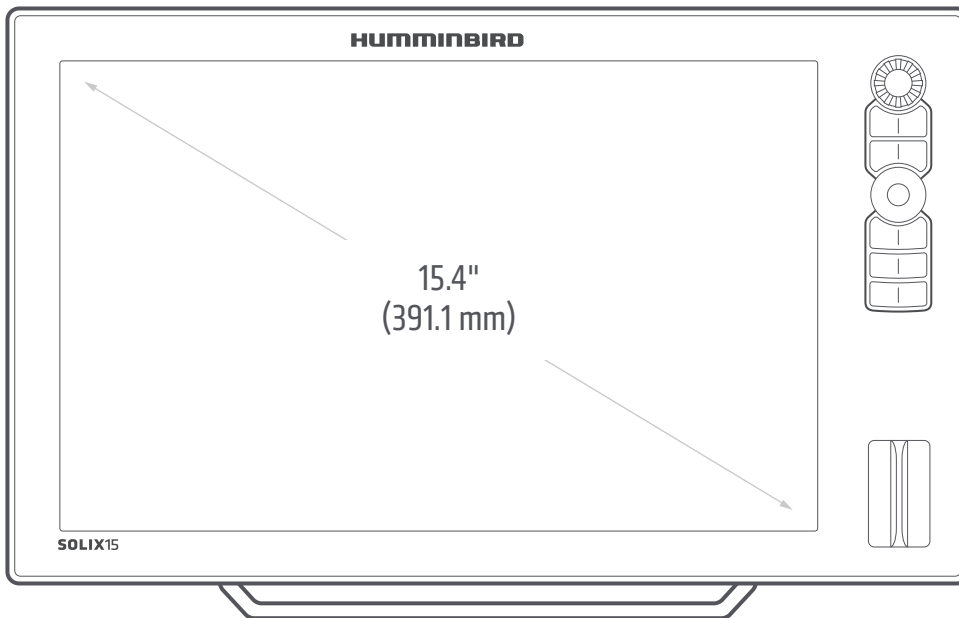

SOLIX 15 Gimbal Mount

| | |
|--------|------------------|
| Width | 16.5" [419 mm] |
| Height | 10.5" [266.7 mm] |
| Depth | 4.8" [122 mm] |

STATEMENTS AND ACKNOWLEDGEMENTS

ENVIRONMENTAL COMPLIANCE STATEMENT: It is the intention of Johnson Outdoors Marine Electronics, Inc. to be a responsible corporate citizen, operating in compliance with known and applicable environmental regulations, and a good neighbor in the communities where we make or sell our products.

WEEE DIRECTIVE: EU Directive 2002/96/EC “Waste of Electrical and Electronic Equipment Directive [WEEE]” impacts most distributors, sellers, and manufacturers of consumer electronics in the European Union. The WEEE Directive requires the producer of consumer electronics to take responsibility for the management of waste from their products to achieve environmentally responsible disposal during the product life cycle.

WEEE compliance may not be required in your location for electrical & electronic equipment [EEE], nor may it be required for EEE designed and intended as fixed or temporary installation in transportation vehicles such as automobiles, aircraft, and boats. In some European Union member states, these vehicles are considered outside of the scope of the Directive, and EEE for those applications can be considered excluded from the WEEE Directive requirement.



This symbol [WEEE wheelee bin] on product indicates the product must not be disposed of with other household refuse. It must be disposed of and collected for recycling and recovery of waste EEE. Johnson Outdoors Marine Electronics, Inc. will mark all EEE products in accordance with the WEEE Directive. It is our goal to comply in the collection, treatment, recovery, and environmentally sound disposal of those products; however, these requirements do vary within European Union member states. For more information about where you should dispose of your waste equipment for recycling and recovery and/or your European Union member state requirements, please contact your dealer or distributor from which your product was purchased.

Caldera Systems, Inc.

The following copyright and license is applicable to the OpenSLP project:

Copyright © 2000 Caldera Systems, Inc.

All rights reserved.

Redistribution and use in source and binary forms, with or without modification, are permitted provided that the following conditions are met:

- Redistributions of source code must retain the above copyright notice, this list of conditions and the following disclaimer.
- Redistributions in binary form must reproduce the above copyright notice, this list of conditions and the following disclaimer in the documentation and/or other materials provided with the distribution.
- Neither the name of Caldera Systems nor the names of its contributors may be used to endorse or promote products derived from this software without specific prior written permission.

THIS SOFTWARE IS PROVIDED BY THE COPYRIGHT HOLDERS AND CONTRIBUTORS “AS IS” AND ANY EXPRESS OR IMPLIED WARRANTIES, INCLUDING, BUT NOT LIMITED TO, THE IMPLIED WARRANTIES OF MERCHANTABILITY AND FITNESS FOR A PARTICULAR PURPOSE ARE DISCLAIMED. IN NO EVENT SHALL THE CALDERA SYSTEMS OR CONTRIBUTORS BE LIABLE FOR ANY DIRECT, INDIRECT, INCIDENTAL, SPECIAL, EXEMPLARY, OR CONSEQUENTIAL DAMAGES (INCLUDING, BUT NOT LIMITED TO, PROCUREMENT OF SUBSTITUTE GOODS OR SERVICES; LOSS OF USE, DATA, OR PROFITS; OR BUSINESS INTERRUPTION) HOWEVER CAUSED AND ON ANY THEORY OF LIABILITY, WHETHER IN CONTRACT, STRICT LIABILITY, OR TORT (INCLUDING NEGLIGENCE OR OTHERWISE) ARISING IN ANY WAY OUT OF THE USE OF THIS SOFTWARE, EVEN IF ADVISED OF THE POSSIBILITY OF SUCH DAMAGE.

HDMI

HDMI™

HIGH-DEFINITION MULTIMEDIA INTERFACE

The end user shall use HDMI compliant cable.

The terms HDMI and HDMI High-Definition Multimedia Interface, and the HDMI Logo are trademarks or registered trademarks of HDMI Licensing LLC in the United States and other countries.

libxml++



NOTE: This product uses libxml++ software. This portion of the software is free software; you can redistribute it and/or modify it under the terms of the GNU Lesser General Public License as published by the Free Software Foundation; either version 2 of the License, or [at your option] any later version. This program is distributed in the hope that it will be useful, but WITHOUT ANY WARRANTY; without even the implied warranty of MERCHANTABILITY or FITNESS FOR A PARTICULAR PURPOSE. See the GNU Lesser General Public License for more details.

You may receive a copy of the GNU Lesser General Public License along with this program; if not, write to the Free Software Foundation, Inc., 51 Franklin Street, Fifth Floor, Boston, MA 02110-1301 USA.

To receive a free copy of the libxml++ software used in this system, please send a letter of request* with the following information:

Name [First & Last]
Phone Number
E-mail Address
Mailing Address
Humminbird serial number
[Your Humminbird unit must be registered at humminbird.com/support/productregistration.aspx.]

Shipping and Handling:

We can only accept requests that include a money order in the amount of \$9.99 to cover shipping and handling. Please allow 4-6 weeks for processing.

Send the letter of request* to the following address:

Software Request
Humminbird
678 Humminbird Lane
Eufaula, AL 36027

***NOTE:** A copy of the libxml++ software is not required to upgrade your fishing system. The Humminbird application software and control head include a separate service warranty. Please see humminbird.com and the separate warranty card included with your unit for details.

libxml12 (The MIT License)

Except where otherwise noted in the source code [e.g. the files hash.c, list.c and the trio files, which are covered by a similar license but with different Copyright notices] all the files are:

Copyright © 1998-2003 Daniel Veillard. All Rights Reserved.

Permission is hereby granted, free of charge, to any person obtaining a copy of this software and associated documentation files [the "Software"], to deal in the Software without restriction, including without limitation the rights to use, copy, modify, merge, publish, distribute, sublicense, and/or sell copies of the Software, and to permit persons to whom the Software is furnished to do so, subject to the following conditions:

The above copyright notice and this permission notice shall be included in all copies or substantial portions of the Software.

THE SOFTWARE IS PROVIDED "AS IS", WITHOUT WARRANTY OF ANY KIND, EXPRESS OR IMPLIED, INCLUDING BUT NOT LIMITED TO THE WARRANTIES OF MERCHANTABILITY, FITNESS FOR A PARTICULAR PURPOSE AND NONINFRINGEMENT. IN NO EVENT SHALL THE DANIEL VEILLARD BE LIABLE FOR ANY CLAIM, DAMAGES OR OTHER LIABILITY, WHETHER IN AN ACTION OF CONTRACT, TORT OR OTHERWISE, ARISING FROM, OUT OF OR IN CONNECTION WITH THE SOFTWARE OR THE USE OR OTHER DEALINGS IN THE SOFTWARE.

Except as contained in this notice, the name of Daniel Veillard shall not be used in advertising or otherwise to promote the sale, use or other dealings in this Software without prior written authorization from him.

Linux Operating System



NOTE: This product uses the Linux operating system. This portion of the software is free software; you can redistribute it and/or modify it under the terms of the GNU General Public License as published by the Free Software Foundation; either version 2 of the License, or [at your option] any later version. This program is distributed in the hope that it will be useful, but WITHOUT ANY WARRANTY; without even the implied warranty of MERCHANTABILITY or FITNESS FOR A PARTICULAR PURPOSE. See the GNU General Public License for more details.

You may receive a copy of the GNU General Public License along with this program; if not, write to the Free Software Foundation, Inc., 51 Franklin Street, Fifth Floor, Boston, MA 02110-1301 USA.

To receive a free copy of the Linux software used in this system, please send a letter of request* with the following information:

Name [First & Last]
Phone Number
E-mail Address
Mailing Address
Humminbird serial number
[Your Humminbird unit must be registered at humminbird.com/support/productregistration.aspx.]

Shipping and Handling:

We can only accept requests that include a money order in the amount of \$9.99 to cover shipping and handling. Please allow 4-6 weeks for processing.

Send the letter of request* to the following address:

Software Request
Humminbird
678 Humminbird Lane
Eufaula, AL 36027

***NOTE:** A copy of the Linux operating system is not required to upgrade your fishing system. The Humminbird application software and control head include a separate service warranty. Please see humminbird.com and the separate warranty card included with your unit for details.

Macho (C++ Machine Objects) (The MIT License)

The Machine Objects class library [in short Macho] allows the creation of state machines based on the "State" design pattern in straight C++. It extends the pattern with the option to create hierarchical state machines, making it possible to convert the popular UML statechart notation to working code in a straightforward way. Other features are entry and exit actions, state histories and state variables.

Copyright © 2005 by Eduard Hiti [feedback to reverse:de.ehiti@macho]

Permission is hereby granted, free of charge, to any person obtaining a copy of this software and associated documentation files (the "Software"), to deal in the Software without restriction, including without limitation the rights to use, copy, modify, merge, publish, distribute, sublicense, and/or sell copies of the Software, and to permit persons to whom the Software is furnished to do so, subject to the following conditions:

The above copyright notice and this permission notice shall be included in all copies or substantial portions of the Software.

THE SOFTWARE IS PROVIDED "AS IS", WITHOUT WARRANTY OF ANY KIND, EXPRESS OR IMPLIED, INCLUDING BUT NOT LIMITED TO THE WARRANTIES OF MERCHANTABILITY, FITNESS FOR A PARTICULAR PURPOSE AND NONINFRINGEMENT. IN NO EVENT SHALL THE AUTHORS OR COPYRIGHT HOLDERS BE LIABLE FOR ANY CLAIM, DAMAGES OR OTHER LIABILITY, WHETHER IN AN ACTION OF CONTRACT, TORT OR OTHERWISE, ARISING FROM, OUT OF OR IN CONNECTION WITH THE SOFTWARE OR THE USE OR OTHER DEALINGS IN THE SOFTWARE.

You are encouraged to provide any changes, extensions and corrections for this software to the author at the above-mentioned email address for inclusion into future versions.

Navionics



WARNINGS: The electronic chart is an aid to navigation designed to facilitate the use of authorized government charts, not to replace them. Only official government charts and notices to mariners contain all information needed for the safety of navigation, and as always, the captain is responsible for their prudent use.

ACKNOWLEDGEMENT OF THIRD PARTY NOTICES AND COPYRIGHT LICENSES: This product may contain cartography and other data from one or more of the following Third Party sources; to the extent that any such source is used, the relevant provisions below shall apply:

“National Oceanic and Atmospheric Administration [NOAA]”, “National Imagery Mapping Agency [NIMA]”, “National Geospatial-Intelligence Agency [NGA]”, “National Agriculture Imagery Program [NAIP]”, “United States Army Corps of Engineers [USACE]”, “United States Geological Survey [USGS], Digital Line Graphic [DLG], Digital Raster Graphic [DRG]”, “Department of Natural Resources [DNR]”, “United States Department of Defense”, “United States Department of Commerce, Bureau of Public Roads & State’s Highway Commission”, “Department of Environmental Protection [DEP]”, “Department of Fish and Wildlife”, “Department of Game and Fishing”, “Ocean Mapping Group, Department of Geodesy and Geomatics Engineering, University of New Brunswick”, “Pennsylvania Fish and Boat Commission [PFBC]”, “Florida Natural Areas Inventory [FNAI]”, “North Carolina Wildlife Resources Commission [NCWRC]”, “New York State, Department of Environmental Conservation”, “National Geophysical Data Center & Great Lakes Environmental Research Laboratory - Great Lakes Information Network”, “Imray Charts”, “Wavey Line Charts Publishing”, “Angler Atlas”, “Fish-n-Map Company”, “Track Map Data”, “Servicio de Hidrografia Naval [SHN], Argentina”, “Western Australia Department of Planning and Infrastructure [DPIWA]”, “Australian Hydrographic Service [AHS]”, “Maritime Safety Agency of State of Queensland [MSQ]”, “@The State of Queensland [Department of the Environment and Resource Management] [DERM]”, “1-Cubed”, “GeoContent”, “DigitalGlobe”, “European Environment Agency [Corine]”, “Algemene Nederlandsche Wiersrijders Bond [ANWB]”, “@ Dutch Ministry of Infrastructure and Environment”, “Dienst Der Hydrografie, Netherlands”, “Vlaamse Hydrografie, Belgium”, “Belgium National Oceanographic Data Centre [BMDC]”, “Management Unit of the North Sea Mathematical Models [MUMM]”, “Landesvermessungsamt Baden-Wurtemberg”, “Bundesamt für Seeschifffahrt und Hydrographie [BSH]”, “Bundesministerium für Verkehr, Bau und Stadtentwicklung – Die Wasser-und Schifffahrtsverwaltung des Bundes [WSW], Germany”, “Geodatastyrelsen [GST]”, “Delius Klasing Verlag [DKV]”, “Estonian Maritime Administration [EMA]”, “Finnish Maritime Administration [FMA]”, “National Land Survey [NLS]”, “Service Hydrographique et Oceanographique de la Marine [SHOM]”, “Hellenic Navy Hydrographic Service [HNHS]”, “Hrvatski Hidrografski Institute [HHI], Croatia”, “Icelandic Coast Guard [ICG]”, “Istituto Idrografico della Marina, Italia”, “Ministero dello Sviluppo Economico, Italia”, “Japan Hydrographic Department”, “Norwegian Hydrographic Service [Statens Kartverk Interreg Geovekst]”, “Nordeca SA”, “Myosa Boating Union”, “State Hydrographic Service Ukraine [SHSU]”, “United Kingdom Hydrographic Office [UKHO], @British Crown Copyright, [2013]”, “British Oceanographic Data Centre [BODC] and the Environment Agency”, “Channel Coastal Observatory”, “IHO-IOC GEBCO Gazetteer of Undersea Feature Names, Bathymetric Contours derived from the GEBCO_08 Grid and GEBCO One Minute Grid; www.gebco.net”, “United Kingdom Department of Energy and Climate Control”, “The database of British and Irish Hills by Graham Jackson and Chris Crocker”, “Swedish Maritime Administration [SMA]”, “Hydrographica AB”, “Instituto Hidrográfico, Portugal [IHPT]”, “Instituto Hidrográfico de la Marina, España [IHM]”, “Ministerio de Agricultura, Alimentación y Medio Ambiente, España [MAGRAMA]”, “Departamento de Medio Ambiente, Planificación Territorial, Agricultura y Pesca, Gobierno Vasco”, “National Hydrographic Office, Sultanate of Oman [NHOSO]”, “South Africa Navy Hydrographic Office [SAN]”, “@ Swisstopo”, “Swiss Lakes Charts with the permission from Cap.Jean DeBosset”, “Abris LLC”, “GeoNames”, “Claymoreclan Design”, “Reliance Globalcom”, “Kingfisher Information Services by Seafish.Org”, “Land Information New Zealand [LINZ]”

This Navionics electronic marine chart incorporates Data which is © “Commonwealth of Australia [“Great Barrier Reef Marine Park Authority”]” 2009. The Data has been used in this Navionics electronic marine chart with the permission of the Commonwealth. The Commonwealth has not evaluated the Data as altered and incorporated within this Navionics electronic marine chart, and therefore gives no warranty regarding its accuracy, completeness, currency or suitability for any particular purpose.

The “Crown in Right of the State of Western Australia” accepts no liability for the accuracy of copying of information contained in this product and does not warrant that this product meets any regulations as an appropriate product for navigation.

This product has been produced by Navionics S.p.A. based on “Canadian Hydrographic Service [CHS]” data, following any minimum standards/guidelines that may have been established by CHS, pursuant to CHS Digital Value-Added Reseller Agreement No. 2012-0605-1260-N. The incorporation of data sourced from CHS in this product shall not be construed as constituting an endorsement by CHS of this product. This product does not meet the requirements of the Charts and Nautical publications Regulations under the Canada Shipping Act, 2001. Certified charts and publications, corrected and up-to-date, must be used to meet the requirements of those regulations.

All above Companies, Institutions and Hydrographic Offices have not verified the product and do not accept liability for its accuracy.

Copyright © 2013 Navionics S.p.A.

Qt Project



NOTE: This product uses Qt software. Qt is licensed under commercial and open source licenses [GNU General Public License version 3 and GNU Lesser General Public License version 2.1]. This portion of the software is free software; you can redistribute it and/or modify it under the terms of the GNU General Public License and GNU Lesser General Public License as published by the Free Software Foundation; either version 3 of the GNU General Public License and version 2.1 of the GNU Lesser General Public License, or [at your option] any later version. This program is distributed in the hope that it will be useful, but WITHOUT ANY WARRANTY; without even the implied warranty of MERCHANTABILITY or FITNESS FOR A PARTICULAR PURPOSE. See the GNU General Public License and GNU Lesser General Public License for more details.

You may receive a copy of the GNU General Public License and GNU Lesser General Public License along with this program; if not, write to the Free Software Foundation, Inc., 51 Franklin Street, Fifth Floor, Boston, MA 02110-1301 USA.

To receive a free copy of the Qt software used in this system, please send a letter of request* with the following information:

Name (First & Last)

Phone Number

E-mail Address

Mailing Address

Humminbird serial number

[Your Humminbird unit must be registered at humminbird.com/support/productregistration.aspx.]

Shipping and Handling:

We can only accept requests that include a money order in the amount of \$9.99 to cover shipping and handling. Please allow 4-6 weeks for processing.

Send the letter of request* to the following address:

Software Request

Humminbird

678 Humminbird Lane

Eufaula, AL 36027

***NOTE:** A copy of the Qt software is not required to upgrade your fishing system. The Humminbird application software and control head include a separate service warranty. Please see **humminbird.com** and the separate warranty card included with your unit for details.

FCC Notice

This device complies with Part 15 of the FCC Rules. Operation is subject to the following two conditions: [1] this device may not cause harmful interference, and [2] this device must accept any interference received, including interference that may cause undesired operation.



CAUTION! This equipment has been tested and found to comply with the limits for a Class B digital device, pursuant to Part 15 of the FCC Rules. These limits are designed to provide reasonable protection against harmful interference in a residential installation. This equipment generates, uses and can radiate radio frequency energy and, if not installed and used in accordance with the instructions, may cause harmful interference to radio communications. However, there is no guarantee that interference will not occur in a particular installation. If this equipment does cause harmful interference to radio or television reception, which can be determined by turning the equipment off and on, the user is encouraged to try to correct the interference by one or more of the following measures:

- Reorient or relocate the receiving antenna.
- Increase the separation between the equipment and receiver.
- Connect the equipment into an outlet on a circuit different from that to which the receiver is connected.
- Consult the dealer or an experienced radio/TV technician for help.

RF EXPOSURE COMPLIANCE: This device has been evaluated and found compliant in accordance with EU EN 62479:2010 and EN 62311:2008 for human RF exposure.

This product has been so constructed that the product complies with the requirement of Article 10[2] as it can be operated in at least one Member State as examined and the product is compliant with Article 10[10] as it has no restrictions on putting into service in all EU member states.

CE EU DECLARATION OF CONFORMITY: Hereby, Humminbird declares that this device is in compliance with the essential requirements and other relevant provisions of Directive 2014/53/EU. The declaration of conformity may be consulted at <https://www.humminbird.com/EU-DOC>.

Class B Device (Broadcasting and communication equipment for home)

This equipment is home use [Class B] electromagnetic wave suitability equipment and to be used at home and it can be used in all areas.

End User License Agreement

This Hydrographic Database is the proprietary and confidential property of Johnson Outdoors Marine Electronics. Unauthorized use, including the copying of this Hydrographic Database, is expressly prohibited. BY USING THE PRODUCT YOU ARE AGREEING TO BE BOUND BY ALL THE TERMS AND CONDITIONS OF THE JOHNSON OUTDOORS ["LICENSOR"] LICENSE AGREEMENT ["AGREEMENT"] WHICH IS PROVIDED WITH THIS COASTMASTER AND/OR LAKEMASTER DIGITAL MAP PRODUCT ["LICENSED PRODUCT"] INCLUDING, WITHOUT LIMITATION, THE USE RESTRICTIONS, WARRANTY DISCLAIMER AND LIMITATIONS OF LIABILITY SET FORTH HEREIN. Under the Agreement, you have a limited, non-exclusive, personal license to use the data contained on the media in this package, on a GPS mapping device for supplemental navigation reference purposes. Licensor and its third-party suppliers retain all rights to the Licensed Product not expressly granted by the Agreement. You are responsible for using official government charts and prudent navigation for safe travel. The Licensed Product and the accompanying documentation are copyrighted works of authorship and contain valuable secret and confidential information proprietary to Licensor and its third-party suppliers who retain the ownership of the information and all copyrights and other proprietary rights therein. You agree to exercise reasonable efforts to protect their proprietary interests. You may NOT modify, adapt, translate, reverse engineer, decompile, disassemble, sub license, rent, lease, or sell any portion of the Data. You may NOT create derivative works based upon the Data. You may NOT place the Data onto a server so that it is accessible via a public network such as the Internet.

LICENSOR AND ITS THIRD-PARTY SUPPLIERS DO NOT WARRANT THE LICENSED PRODUCT WILL MEET YOUR REQUIREMENTS OR THAT ITS OPERATION WILL BE UNINTERRUPTED OR ERROR-FREE. IN NO EVENT WILL COASTMASTER, LAKEMASTER OR ITS SUPPLIERS BE LIABLE TO YOU FOR ANY CONSEQUENTIAL OR INCIDENTAL DAMAGES. Some states or jurisdictions do not allow the exclusion or limitation of consequential or incidental damages, so the above limitations may not apply to you.

Portions of Humminbird Basemap® OpenStreetMap contributors. Portions of Humminbird Basemap sourced from GeoBase®.

Portions of Humminbird Basemap contains information licensed under the Open Government Licence Canada. Portions of Humminbird Basemap copyright 2001 Her Majesty the Queen in Right of Manitoba, as represented by the Minister of Conservation. All rights reserved. Portions of Humminbird Basemap contains information licenced under the GeoNB Open Data Licence. Portions of Humminbird Basemap contains information licenced under the Open Government Licence Ontario.

CONTACT HUMMINBIRD

Contact Humminbird Technical Support in any of the following ways:

Web site:

humminbird.com

E-mail:

service@humminbird.com

Telephone:

1-800-633-1468

Direct Shipping:

Humminbird
Service Department
678 Humminbird Lane
Eufaula, AL 36027 USA

Hours of Operation:

Monday - Friday

8:00 a.m. to 4:30 p.m. [Central Standard Time]

Social Media Resources:



[Facebook.com/HumminbirdElectronics](https://www.facebook.com/HumminbirdElectronics)



[Twitter.com \[@humminbirdfish\]](https://twitter.com/@humminbirdfish)



[Instagram.com/humminbird](https://www.instagram.com/humminbird)



[YouTube.com/humminbirdtv](https://www.youtube.com/humminbirdtv)

