



**HONDA 5, 8, 9.9 & 15HP  
1980-2000**

TrollMaster is a precision throttle control designed to achieve the maximum in trolling speed accuracy. The memory feature included in this control will allow returning to the best fishing speed time and time again. Whether you are pulling your bait or back trolling, TrollMaster is the answer to your speed control needs. Spend your time trolling, not going to the motor to adjust the speed.

**CALL: 866-228-7655**

**EMAIL: [info@marinetechproducts.com](mailto:info@marinetechproducts.com)**

**MAIL: - NEW ADDRESS AS OF MARCH 1<sup>ST</sup>, 2013**

**MARINETECH PRODUCTS, INC.**

**TROLLMASTER**

**1360 EAST COUNTY ROAD E**

**VADNAIS HEIGHTS, MN 55110**

**PHONE: 651-486-2010**

**FAX: 651-486-6989**

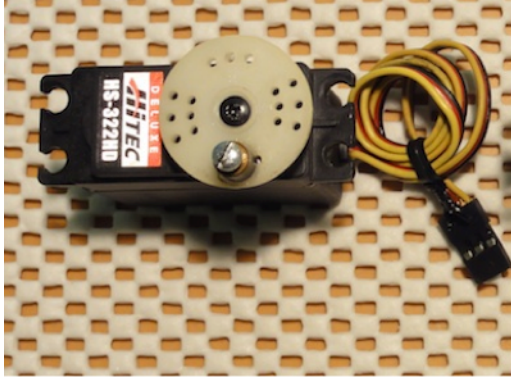

The servo motor pictured above is the old style servo motor. You will see the old style servo motor pictured in the installation manual photos but we have since upgraded to the TM-MG1 servo motor. You will receive the TM-MG1 servo motor in your Trollmaster hardware kit. When installing your servo motor follow the directions for your application and use the brass barrel connector with the phillips head screw in it as your alignment point when you set the position of the servo arm. See; Set The Servo Arm for further instruction on how to install your servo motor properly.

Replacement servo motors are available for the Hitec HS322HD (shown above) and the SG-5010 (not shown)

To purchase call MarineTech Products, Inc. PH: 866-228-7655

## HONDA 5 HP INSTALLATION

1. Remove one leg of bracket as shown.
2. Bend the leg horizontally 45 degrees as shown.
3. Attach the TrollMaster control motor in position as shown.
4. Loosen inside carburetor manifold bolt where it fastens to the engine.
5. Slip the bracket leg under the bolt and tighten\_ Bracket is HORIZONTAL when installed correctly.
6. Remove corner of bracket as shown for cowling clearance.
7. Attach throttle rod as shown.

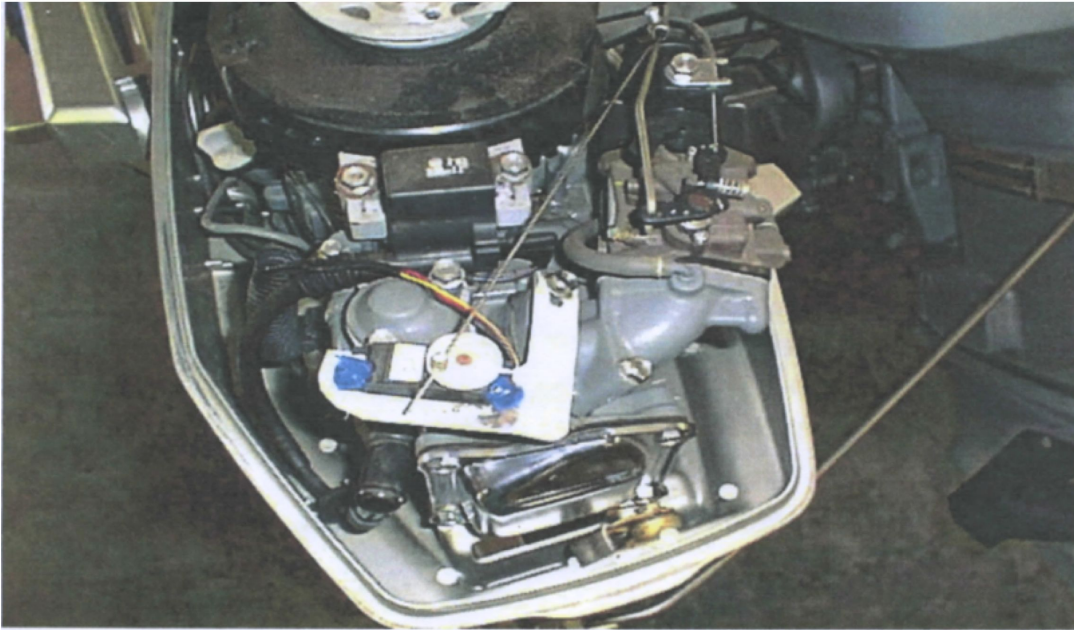

## HONDA 9.9 & 15 HP INSTALLATION

(The stop is not used)

1. Select Bracket (B)
2. Mount the servomotor as shown in the photo.
3. Loosen the bolts located on the thermostat and oil filter housing. Position the bracket under these bolts \_ (see photo) tighten bolts.
4. The servomotor will be positioned above the idle adjustment screw on the inside of the Honda carburetor. The servo motor will push down on the linkage to increase speed

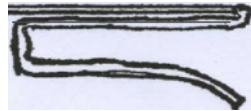

5. Place this end of the linkage over the part of the carburetor lever that the idle setscrew comes in contact with.
6. With the TrollMaster control connected to your battery and the servomotor plugged in, turn the unit on and leave it in IDLE mode.
7. Remove the servo arm from the servo body; insert the linkage into the brass connector.  
Replace the arm at approximately 45 deg Tighten the connector set screw leaving approximately 11/64" clearance at the carburetor end of the linkage.

## Honda 5 & 8 HP 4 Cycle

Using needle nose pliers form a loop on the end of the rod provided. Then bend 90 degrees on the bend line.

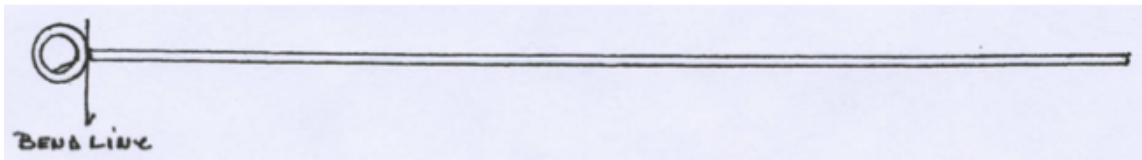

## Honda 9.9 & 15 HP Form rod as follows.

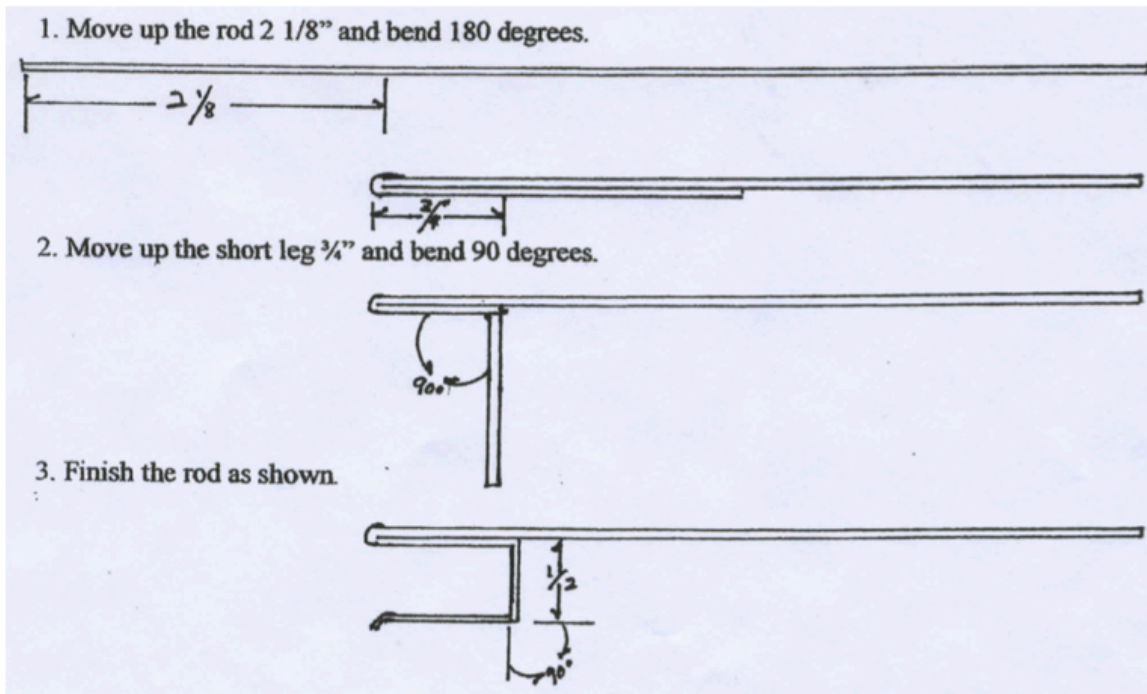

## Honda 8 HP Installation

1. Use Bracket A
2. Attach the servomotor to the bracket shown.
3. Loosen the voltage regulator attaching bolts.
4. Slip the bracket under the bolt heads and tighten bolts.
5. Check clearance to insure nothing is rubbing and the cowling is not touching the servomotor.

## Throttle Rod Installation

1. Select the rod with the round end.
2. The servomotor will push the rod forward to increase speed.
3. Disconnect the Honda throttle rod at the end opposite the carburetor.  
NOTE the rod position before disconnecting.
4. Place the TrollMaster linkage over the Honda throttle rod.
5. Place the stop on the rod.
6. Replace the throttle to its original position.
7. With the control connected to your battery, tum the unit on and leave it in IDLE mode.
8. Remove the wheel from the servomotor. Slip the linkage onto the connector. Do not tighten the setscrew.
9. With the unit in idle mode, replace the servo arm with the brass connector at the 4:30 position.
10. Move the stop approximately 1/64" from the end of the linkage and tighten setscrew. H. Using the operation information, test the movement of your TrollMaster.

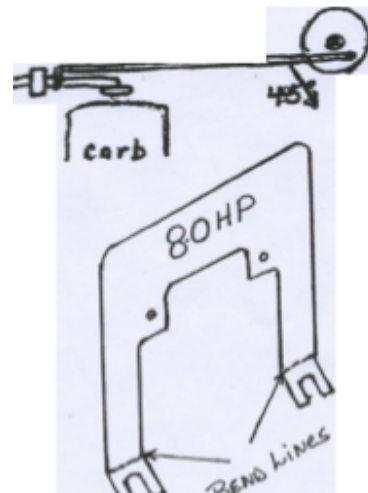

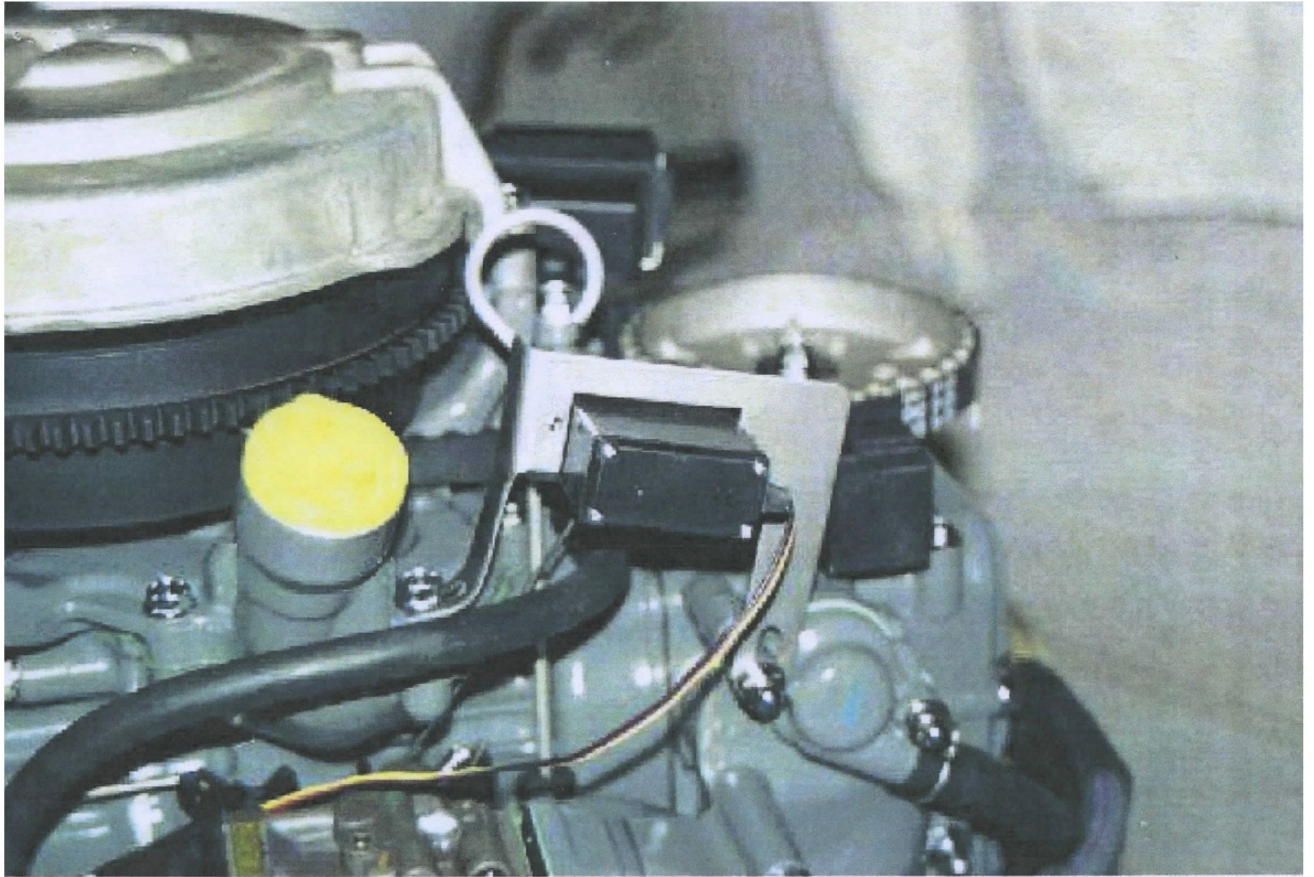

*Honda 9.9 PRE 2001 in pic but similar look and feel for the 15HP motor as well.*

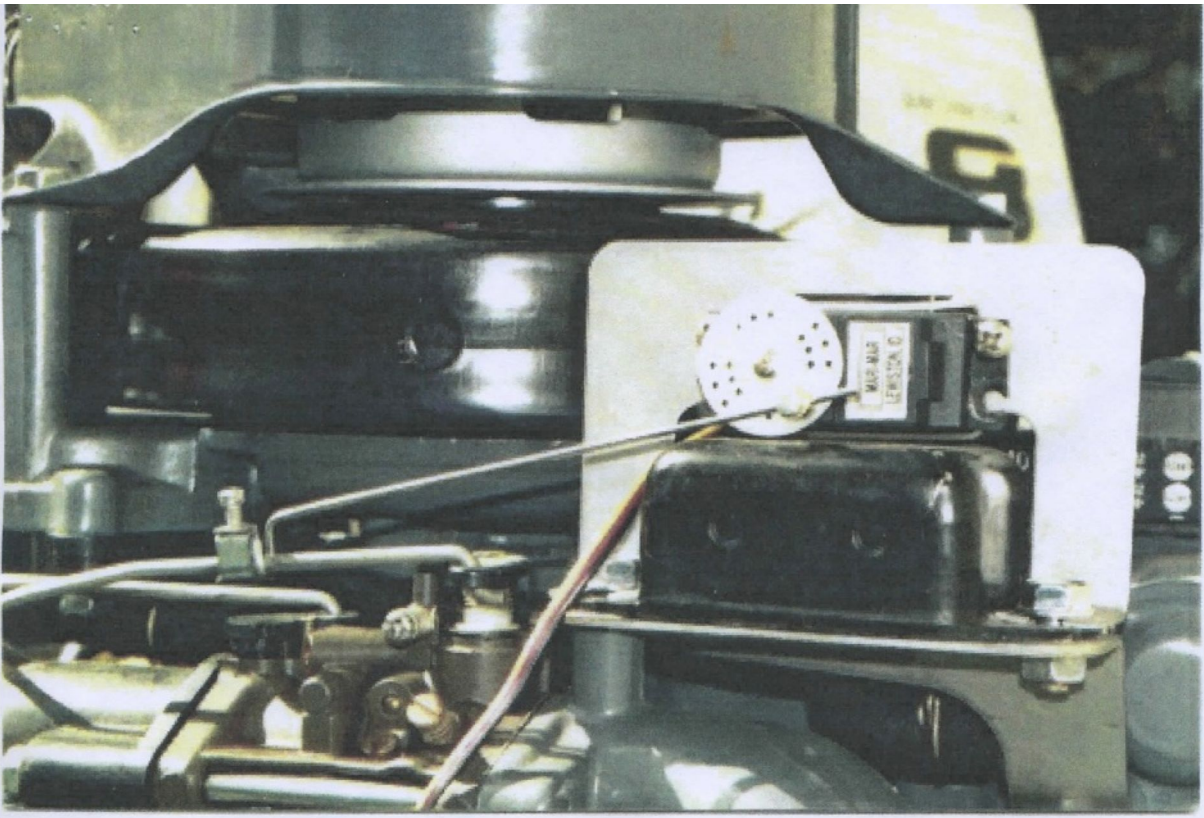

HONDA 8HP



### **Connecting to a power source:**

It is recommended that you install a two-amp fuse on the positive power lead of the PRO and PRO2 models before connecting to a power source. Connect the two amp fused **Red wire to +12 volts DC** and the **Black wire to -12 volts DC**. For PRO3 models connect the **RED wire to +12 volts DC** and the **Black wire to -12 volts DC**. PRO3 models come with a thirty (30) amp fuse installed.

### **Connecting the servo:**

Connect the servo cable to the control cable with the brown wire aligned to the white mark on the control cable plug. After the servo is plugged in, move on to set the servo arm.

### **Set the servo arm:**

Power the unit ON and leave the unit in IDLE mode. By removing the Phillips head screw that holds the servo arm on the servo body you can remove the servo arm by pulling it off of the servo body. Adjust the servo arm to be in the position as shown in the installation manual photos and place the servo arm back on the servo body and return the Phillips head screw to its original location to hold the servo arm in place.

### **Testing the controller:**

You do not have to run your outboard motor to test the TrollMaster unit. Test the controller by powering the unit on and press the IDLE button to put the unit into RUN mode. By turning the control knob with a clockwise rotation the servo should move the carburetor from IDLE to FULL THROTTLE.

NOTE: Full throttle can be adjusted by changing the position of the servo arm on the servo motor.

## **Troubleshooting:**

If you should encounter an issue with your TrollMaster use these tips to determine the best course of action to resolve the issue.

**Problem:** The unit powers on and the display functions properly, your buttons show function on the screen and the numbers increase when turning the speed adjustment knob but there is no response from the servo motor.

**Solution:** Verify the servo motor is plugged in accordingly with the brown wire aligned with the white mark on the control cable plug and test again. If there is still no response, replace the servo motor with a new one and test again. If after replacing the servo motor and testing again there is still no response contact MarineTech Products Inc. 866-228-7655 to have the unit inspected at our facility.

**Problem:** The unit powers on works momentarily then powers off. The unit will not stay powered on.

**Solution:** Check your battery voltage; if the battery voltage is low the unit will not operate properly. When in doubt charge your battery to ensure there is enough voltage to operate the TrollMaster unit to its fullest potential. If the battery is fully charged and the unit is still not operating properly contact MarineTech Products, Inc. 866-228-7655 to have the unit inspected at our facility.

**If you need assistance with Troubleshooting contact MarineTech Products, Inc. For tech support. Call 866-228-7655**

## **TrollMaster Replacement Parts:**

### **TrollMaster Servo Motor (TM-MG1)**

Note: A Servo Arm is included with the purchase of a replacement Servo Motor.

### **TrollMaster Servo Arm (TM-Servo Arm)**

Note: A replacement screw to mount the Servo Arm to the Servo Body is included with the purchase of a replacement Servo Arm.

### **TrollMaster Hardware Kit (TMXXXHRDWRKIT)**

Note: Replace the XXX with the Kit number that applies to your outboard motor. See the Application Guide for kit number.

Example: TM206HRDWRKIT.

### **TrollMaster Electronics Unit Only (TMXXXUNITONLY)**

Note: Replace the XXXX with the model of Replacement TrollMaster Electronics you wish to purchase. Comes with controller and wiring only, does not include servo motor or hardware kit.

Examples: TMPROUNITONLY, TMPRO2UNITONLY, TMPRO3UNITONLY.

## **To Order Replacement Parts:**

If you would like to order any of the above mentioned replacement parts check with your local retailer, if they do not have the item in stock they can order it for you or you can order directly from MarineTech Products, Inc. For pricing and availability call MarineTech Products, Inc. 866-228-7655

## **Installation Guides:**

The installation Guide on this disk can also be found online at MarineTech Products website, visit: [www.marinetechproducts.com](http://www.marinetechproducts.com) and follow the TrollMaster link to the TrollMaster page where you will find the Installation Guides for every motor we make a kit to fit. The Application Guide is also on the same web page; the Application Guide shows the full list of motors we make kits to fit with the product part numbers for those kits.

# SERVICE AND WARRANTY

Should your unit ever require service please *do not return the product to your dealer*.

Instead call the number below for special instructions on shipping and handling. Be sure to call between 9 00 AM and 4.00 PM (Central Time) Monday through Friday. If the service required is covered by the warranty, it will be repaired or replaced as described below. If the service required is NOT covered by warranty replacement parts are available for purchase and paid for by a major credit card.

The warranty coverage on this equipment is limited to the terms set forth below:

MarineTech Products, Inc. warrants this product to be free of defects in material and workmanship for a period of ONE (1) YEAR from the date of original retail purchase. Positive proof of date of purchase is required for warranty service. If the service required is covered by warranty, you *must* obtain a *Return Authorization* number from MarineTech Products. The unit will be repaired or replaced with new or factory rebuilt parts at no charge. The defective components must be returned to the address specified, with shipping charges prepaid. Be sure to include your name, address, telephone number and a copy of the sales receipt showing the date of original retail purchase. All sales receipts are subject to verification.

This warranty does not apply if the unit has been damaged by accident, abuse, misuse, poor installation or misapplication, or if it has been modified from its original condition, or if any serial number has been removed or defaced or altered. This warranty does not cover any expense to remove or reinstall the unit or any of its components. If a returned unit is not covered by warranty, the sender will be notified and given an estimate of the charges to repair or replace the unit together with the return shipping charges.

THIS WARRANTY DOES NOT COVER SPECIAL, INCIDENTAL, OR CONSEQUENTIAL DAMAGES RESULTING FROM ANY BREACH OF WARRANTY, OR UNDER ANY OTHER LEGAL THEORY, INCLUDING BUT NOT LIMITED TO DAMAGE TO OR REPLACEMENT OF OTHER EQUIPMENT AND PROPERTY. THE WARRANTY AND REMEDIES SET FORTH ARE EXCLUSIVE AND IN LIEU OF ALL OTHERS, WHETHER ORAL OR WRITTEN, EXPRESS OR IMPLIED. DUE TO THE SPECIAL AND UNIQUE CONDITIONS THAT MAY EXIST IN EACH APPLICATION, THE MANUFACTURER SPECIFICALLY DISCLAIMS ANY AND ALL IMPLIED WARRANTIES OF MERCHANTABILITY AND FITNESS FOR A PARTICULAR PURPOSE. NO DEALER, AGENT OR EMPLOYEE IS AUTHORIZED TO MAKE ANY MODIFICATION, EXTENSION OR ADDITION TO THIS WARRANTY.

Some states do not allow exclusion of incidental or consequential damages, so the above exclusions may not apply to you. This warranty gives you specific legal rights, and you may also have other legal rights, which may vary from state to state.

**FOR SERVICE CALL: 1 651 486 2010**