



FOR MODEL NUMBERS MD4041 AND MD4042

---

# OWNER'S MANUAL

## MIT 70

**MD4041** INFLATABLE FLOTATION  
DEVICE MANUAL INFLATION MODEL

APPROVED BY UNITED STATES COAST  
GUARD AND TRANSPORT CANADA

**WARNING:** THE MD4041 WILL NOT  
INFLATE AUTOMATICALLY UPON  
IMMERSION. TAB MUST BE PULLED TO  
ACTIVATE INFLATION MECHANISM.

**MD4042** INFLATABLE FLOTATION  
DEVICE MANUAL WITH AUTOMATIC  
BACKUP INFLATION MODEL

APPROVED BY UNITED STATES COAST  
GUARD AND TRANSPORT CANADA

---

DO NOT REMOVE PRIOR TO SALE  
HT1157 REV 05MAY2023

# TABLE OF CONTENTS

ABOUT THIS PRODUCT.....	1
WHAT IS AN INFLATABLE FLOTATION DEVICE?.....	1
AIRLINE OPERATOR POLICY ON CARRIAGE OF INFLATABLE PFDS AND CO <sub>2</sub> CARTRIDGES.....	2
APPROVAL CONDITIONS AND CARRIAGE REGULATIONS.....	2
MANDATORY CARRIAGE REQUIREMENTS.....	3
WHY ARE FLOTATION DEVICES REQUIRED SAFETY EQUIPMENT?.....	3
INSTRUCTIONS FOR USE .....	3
GETTING TO KNOW YOUR FLOTATION DEVICE.....	3
INSPECTING COMPONENTS.....	4
USE AT COLD TEMPERATURES.....	5
PUTTING IT ON (DONNING).....	6
WEAR IT ON THE OUTSIDE AND INTACT! .....	6
TAKING IT OFF (DOFFING).....	6
INFLATING.....	7
1) MANUALLY .....	7
2) AUTOMATICALLY AS BACKUP (MD4042) .....	7
3) ORALLY ....	7
SPECIAL CONSIDERATIONS FOR AUTOMATIC DEVICES.....	8
DEFLATING .....	9
RE-ARMING (MD4041).....	10-11
RE-ARMING (MD4042) .....	12-13
REPACKING.....	14
IS YOUR FLOTATION DEVICE IN GOOD AND SERVICEABLE CONDITION?.....	14

CARE AND MAINTENANCE INSTRUCTIONS.....	15
BEFORE EACH WEAR.....	15
EVERY 6 MONTHS.....	15
LEAK TEST.....	15
THOROUGH VISUAL EXAMINATION.....	15
AFTER EACH INFLATION.....	16
ANNUALLY.....	16
CLEANING AND STORING.....	16
HOW AND WHY TO TEST YOUR FLOTATION DEVICE.....	17
MAKE SURE IT FLOATS YOU.....	17
MAKE SURE IT WORKS.....	17
LEARN HOW IT WORKS.....	17
TRYING YOUR FLOTATION DEVICE.....	19
HOW TO TEST YOUR FLOTATION DEVICE USING:	
THE <b>AUTOMATIC INFLATOR</b> .....	20
THE <b>MANUAL INFLATOR</b> .....	21
THE <b>ORAL INFLATOR</b> .....	22
CHOOSE A FLOTATION DEVICE	
THAT YOU WILL WANT TO WEAR.....	23
COLD SHOCK.....	23
HYPOTHERMIA.....	23
MAKE SURE YOUR DEVICE FUNCTIONS PROPERLY.....	24
ADDITIONAL INFORMATION.....	25
DO NOT ATTACH FLOTATION DEVICES TO YOUR BOAT.....	25

## ABOUT THIS PRODUCT

The **MIT 70** (which includes models **MD4041** and **MD4042**) is from Mustang Survival's Inshore Flotation series, specifically designed for activities where adventurers can see the shore in calm or inland waters.

Your Mustang Survival MIT 70 flotation device is the smallest approved inflatable flotation device, designed for multi-sport individuals seeking a versatile solution. It is discreet and lightweight and can support any adventure without compromising safety in inshore conditions.

Here are some of the features that set this product apart, and make it particularly well suited to many inshore activities:

- Automatically inflates upon water immersion (**MD4042 only**)
- Manually inflates by pulling the inflator pull-tab
- Exclusive Membrane Inflatable Technology (MIT) creates a lightweight, flexible fit
- Easy-access inflator eases re-arming
- Provides at least 70 Newtons (15.7 lbs) buoyancy when inflated
- High visibility, contrasting fabric when inflated increases visibility in rescue scenarios
- Belt extender sold separately (model MA7637)

This flotation device is designed for wearers over 16 years of age, with a chest range of 76-132 cm (30-52 inches), and weighing over 40 kg (88 lbs).

## WHAT IS AN INFLATABLE FLOTATION DEVICE?

While traditional flotation devices are inherently buoyant, this flotation device relies entirely on inflation for buoyancy. Uninflated, your device is designed to offer maximum mobility with minimum bulk. **The MIT 70** is a comfortable slim collar that can be inflated at any time with a 17-gram carbon dioxide (CO<sub>2</sub>) gas cylinder to provide at least 70 Newtons (15.7 lbs) buoyancy. **The MD4041 model** can be inflated either manually by jerking a pull-tab or orally (by mouth). **The MD4042 model** can be inflated either automatically during water immersion, manually by jerking a pull-tab, or orally (by mouth). We recommend that you familiarize yourself with your device as described in "Instructions for Use," page 3.

## **AIRLINE OPERATOR POLICY ON CARRIAGE OF INFLATABLE PFDs AND CO<sub>2</sub> CARTRIDGES**

Please be aware that regulations may apply to the air transport of this product. With the approval of the aircraft operator, CO<sub>2</sub> cylinder(s) may be carried by a passenger or crew in checked or carry-on baggage.

Please consult airline operator policy.

## **APPROVAL CONDITIONS AND CARRIAGE REGULATIONS**

This inflatable flotation device is approved by Transport Canada and the U.S. Coast Guard. It is not approved for white water paddling, water skiing or other high impact, high speed activities. This inflatable flotation device was designed to be more comfortable and less restrictive to wear than inherently buoyant flotation devices. When worn, used, and serviced according to this owner's manual, this flotation device can greatly increase your chances of survival in the water. Not recommended for non-swimmers or weak swimmers. Users of this inflatable flotation device must be at least 16 years old.

## **MANDATORY CARRIAGE REQUIREMENTS**

The U.S. Coast Guard and Transport Canada require you to carry approved flotation devices of the correct size for each person on board that are legibly marked with an approval number and are in good and serviceable condition. To be considered serviceable, this flotation device shall not exhibit deterioration that could diminish its performance such as broken or deformed hardware, detached webbing, rotted structural components, air leaks, or nonfunctional oral inflation tube. Unless worn inflated, this flotation device must also be properly armed with a full CO<sub>2</sub> cylinder, inflation system status indicator, and an accessible manual inflation lanyard. A flotation device which is "approved only when worn" or "required to be worn" must be worn under the specified conditions.

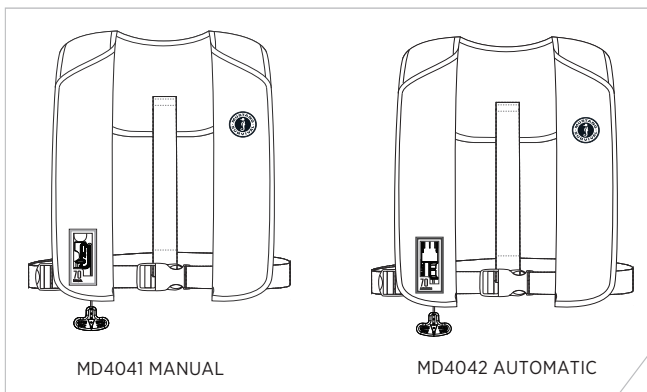

## WHY ARE FLOTATION DEVICES REQUIRED SAFETY EQUIPMENT?

Drowning is the leading cause of fatalities involving recreational boating. In over 80 percent of fatal incidents the person was not wearing flotation, and most of these occurred after falls overboard or capsizing of small boats. An approved flotation device, when worn, helps raise your head above water in the first critical moments of immersion. Some devices are designed to keep you face up in the water, and increase your chances for survival and rescue. Different body types float differently, and some boating activities require special features in a flotation device.

## INSTRUCTIONS FOR USE

### GETTING TO KNOW YOUR FLOTATION DEVICE

Because your flotation device is designed to save your life, you need to be comfortable using it and thoroughly familiar with how it works. If you just purchased or have not yet used your flotation device, Transport Canada and the U.S. Coast Guard recommend that you immediately test it as described in “How and Why to Test Your Flotation Device,” page 17. This will not only ensure your device is in good condition, it will give you experience using all methods of inflation.

After initial testing, get in the habit of inspecting your flotation device before each use, re-arming it after each use, and of course wearing it every time you go out on the water.

## INSPECTING COMPONENTS

Before each use, check your flotation device for readiness:

1. Place your flotation device with logo facing up on a flat surface with the bottom of the device facing you. At the bottom of the left lobe, lift the inflator cover to expose the inflator and cylinder assembly. Examine the service indicator to ensure it is green (Fig. 1). If the service indicator is red, the mechanism has been fired or is incorrectly fitted and must be re-armed (see “Re-arming” on page 10 for MD4041 or page 12 for MD4042). **The status indicator must be GREEN before you proceed.**

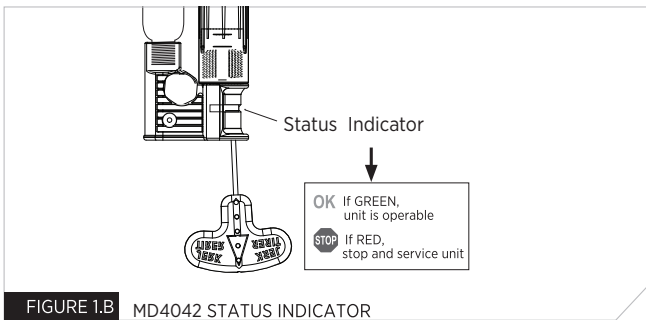
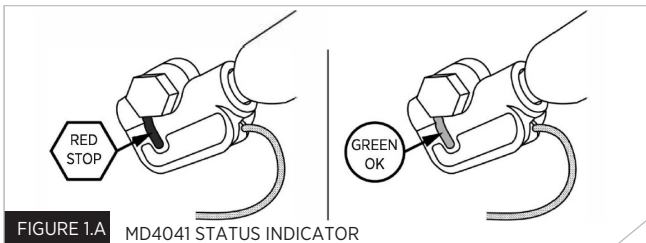

2. For the **MD4042 only**: Ensure the bobbin (Fig. 2) is valid by checking the expiration date on the side of the bobbin. If the bobbin has expired, re-arm your flotation device (see “Re-arming” on page 12).
3. Undo the Velcro™ strips along both sides of the flotation device.
4. Ensure the oral-inflation cap is in the stowed position (Fig. 7).
5. Check for damage or excessive abrasion, wear, tear and/or any visible foreign matter, such as mildew or oil stains. Check that all seams are secure, and all straps and hardware are sound. If you see any signs of damage, perform the “Every Six Months” tests, described in “Care and Maintenance,” page 15.
6. Ensure the pull-tab lanyard is hanging on the outside, and secure the Velcro™ strips on both sides of the flotation device.

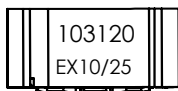

Manufacture Date (MMDDYY)

Expiration Date (EX MM/YY)

FIGURE 2

---

CONTACT YOUR MUSTANG DEALER IF YOU HAVE ANY CONCERNS ABOUT THE READINESS OF YOUR FLOTATION DEVICE.

---

## USE AT COLD TEMPERATURES

As temperatures approach freezing, your inflatable flotation device will provide less buoyancy and will inflate more slowly. At temperatures near freezing, the device should be worn *partially inflated* to ensure that some buoyancy is immediately available to you if you fall overboard. The oral inflator can then be used to adequately top up the flotation device after CO<sub>2</sub> inflation.

**Caution:** Do not fully inflate the device orally and then activate the CO<sub>2</sub> cylinder. The resulting overpressure could seriously damage the device resulting in loss of flotation.

Inflatable flotation devices are not recommended for use in temperatures below freezing.



## PUTTING IT ON (DONNING)

It is important that your flotation device fits properly. Incorrect fit or improper fastening of attachments could impede its effectiveness.

1. Put the flotation device on just like a vest (Fig. 3), with the fabric panels in the front, and fasten the front buckle.
2. Adjust the waist belt using its side buckle, and secure the belt's loose end with the belt loop. All belts and straps are already threaded correctly and only need to be adjusted for fit. The belt should sit below your rib cage, tightened to fit snugly.

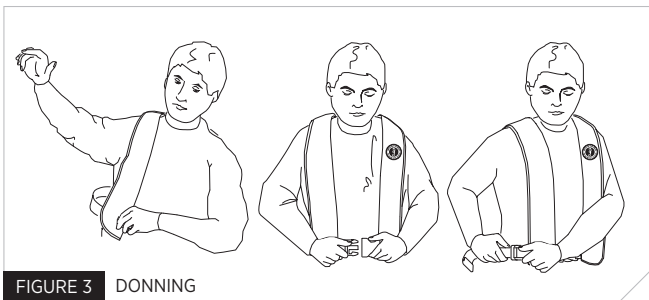

3. Check the fit by pinching the belt strap, just as you would a waistband. If you can pinch the material together, tighten your flotation device.

### **Wear it on the outside and intact!**

Always wear inflatable flotation devices over clothing (as the outermost layer) to avoid restricted inflation, which could cause personal injury and/or damage to your device.

Do not tie or sew anything to the outside of (or around) your flotation device, as it may compromise your device's ability to inflate.

## TAKING IT OFF (DOFFING)

1. If your flotation device has been inflated, partially deflate it while still wearing it to make doffing easier.
2. Loosen your waist belt and unfasten the front buckle.
3. Slip your arms out of the straps.

# INFLATING

Your flotation device inflates manually, orally, and (for MD4042 only) automatically. No matter how your flotation device inflates, it can always be topped up orally – extending your ability to keep afloat.

The inflation instructions below use ‘left’ and ‘right’ assuming you are wearing the flotation device during inflation – so your left or right is also the device’s.

## 1. Manually

Activate the inflation system by jerking firmly downward on the pull-tab (Fig. 4). The flotation device should fully inflate within five seconds.

## 2. Automatically as backup (MD4042)

Inflation will occur automatically within 10 seconds after the inflator is immersed in water. The water-sensing bobbin will disintegrate, triggering a spring-loaded plunger, which punctures the CO<sub>2</sub> cylinder (Fig. 10) to inflate the flotation device. **See also “Special Considerations for Automatic Devices,” next page.**

## 3. Orally

To orally inflate the flotation device, first locate the oral inflation tube by opening your left front panel. Remove the cap from the end of the oral tube and blow into the tube until the flotation device is fully inflated (Fig. 5). Place the oral tube cap back in the stowed position (Fig. 7).

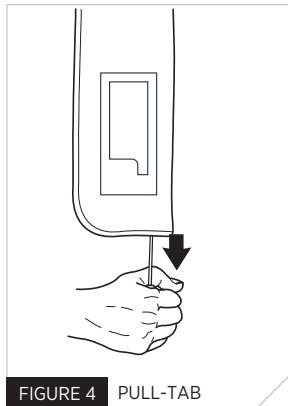

FIGURE 4 PULL-TAB



FIGURE 5 ORAL INFLATION

---

### **CO<sub>2</sub> ESCAPES THROUGH THE MATERIAL OVER TIME**

Manual (and automatic) inflation uses carbon dioxide (CO<sub>2</sub> gas) to fill your flotation device. Over time, the CO<sub>2</sub> gas will slowly escape through the fabric, and you may feel that the flotation device is losing pressure. If you're in the water for a prolonged period, you may need to top up your device orally.

---

---

### **AVOID DOUBLE INFLATION!**

Do not manually or automatically activate the inflator when your flotation device is filled with air. Doing so will result in excessively high pressure within the inflation chamber, which may cause permanent damage to your device and/or extreme discomfort to you.

---

## **SPECIAL CONSIDERATIONS FOR AUTOMATIC DEVICES**

### **(MD4042)**

The flotation device might not be armed when needed, either knowingly or unknowingly, which is why before each use you should inspect the inflator and ensure the service indicator is green.

Another consideration is premature automatic inflation, which can occur in certain conditions, including when the device is subjected to heavy splashing, high humidity, heavy fog, and heavy rain. If you are using the device in these types of conditions, you may choose to instead use a manual device or an automatic device where the inflator requires hydrostatic pressure to activate.

Premature inflation when you are in an awkward place or position could cause personal injury and/or damage to the device. Premature inflation when the device is stored in a tight space could cause damage.

If this flotation device should inflate prematurely, you must re-arm according to the instructions in this manual, using a re-arm kit (MA4041).

# DEFLATING

Complete deflation is easiest when you are not wearing the flotation device.

1. To deflate the flotation device, reverse the oral inflator cap and insert it into the valve. The cap will not lock in the deflate position, so you must hold it in place (Fig. 6).
2. Gently squeeze the flotation device until all air or gas has been expelled. Put the cap back in its stowed position on the oral inflator (Fig. 7).

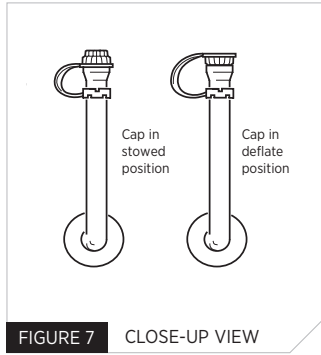
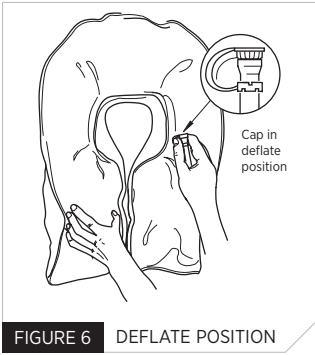

## REARMING (MD4041)

To re-arm your flotation device, you will need Mustang Survival's Re-Arm Kit (MA4041). The spent inflation parts will first be removed, and replacement parts will be installed. The re-arm kit includes:

- ✓ 17g CO<sub>2</sub> cylinder
- ✓ Bobbin (which you will not use for MD4041)

---

### WARNING

- Use only with specified PFD/life jacket models.
  - The gas (CO<sub>2</sub>) cylinder is under pressure, therefore misuse can be dangerous.
  - Avoid prolonged exposure to sunlight, do not store above 120°F (50°C).
  - Do not throw into open fire (incinerate) or dump at sea.
  - Keep away from children.
  - Dispose of CO<sub>2</sub> cylinders only when empty.
  - Discharge and dispose of corroded or rusty cylinders.
  - Bobbin will dissolve in water.
- 

**IMPORTANT: FOLLOW THE INSTRUCTIONS IN THE EXACT SEQUENCE BELOW.**

---

1. Unpack or open the deflated PFD/life jacket (see pg. 9) on a flat surface and expose the inflator.
2. Remove the cylinder by rotating counterclockwise and then pull out (see Fig. 8). Discard the used cylinder.

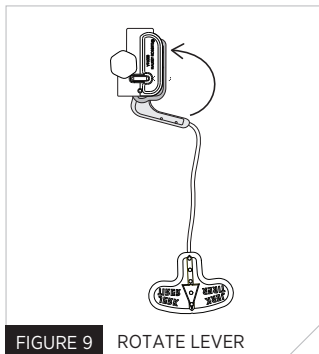
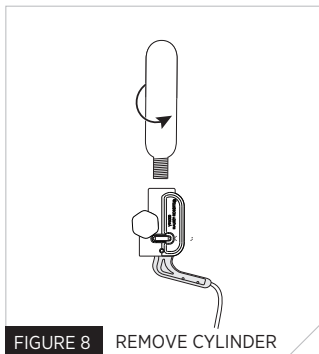

3. Check the manual inflation system to determine that the lever arm moves freely by moving the lever (attached to the pull tab) several times down and up. There should be no binding of mechanical parts.

4. Rotate the yellow lever back towards the inflator so that it is flush against the grey body. The yellow lever should not be extending out from the inflator (see Fig. 9).
5. Check the new cylinder. Ensure that the CO<sub>2</sub> cylinder has not been pierced (see Fig. 10).
6. Install new cylinder (see Fig. 11). Hand-tighten until snug.

**WARNING: IF THE LEVER ARM IS NOT FLUSH AGAINST GREY BODY THE CYLINDER MAY BE PIERCED.**

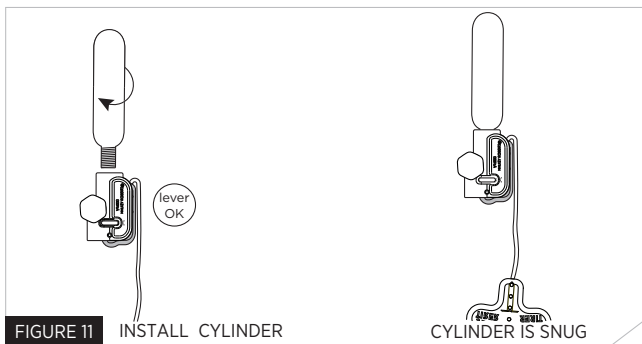
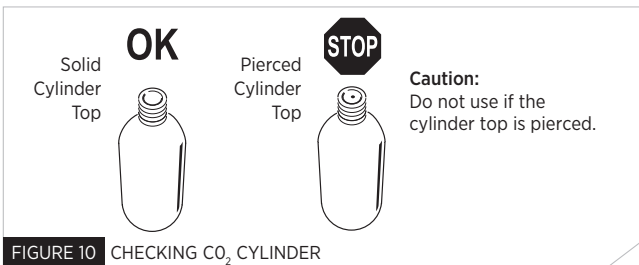

7. Check to be sure status indicator is GREEN (see Fig. 12).

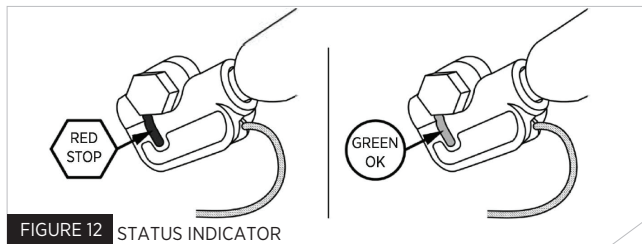

8. Refold the PFD in accordance with the Repacking section (see "Repacking Your PFD" page 14). Your MD4041 Inflatable PFD is now ready for manual use.

## REARMING (MD4042)

To re-arm your flotation device, you will need Mustang Survival's Re-Arm Kit MA4041. The spent inflation parts will first be removed, and replacement parts will be installed. The re-arm kit includes:

- ✓ 17g CO<sub>2</sub> cylinder
- ✓ Bobbin

---

### WARNING

- Use only with specified PFD/life jacket models.
- The gas (CO<sub>2</sub>) cylinder is under pressure, therefore misuse can be dangerous.
- Avoid prolonged exposure to sunlight, do not store above 120°F (50°C).
- Do not throw into open fire (incinerate) or dump at sea.
- Keep away from children.
- Dispose of CO<sub>2</sub> cylinders only when empty.
- Discharge and dispose of corroded or rusty cylinders.
- Bobbin will dissolve in water.

---

### IMPORTANT: FOLLOW INSTRUCTIONS IN THE EXACT SEQUENCE BELOW.

---

1. Unpack or open the deflated PFD/life jacket (see pg. 9) on a flat surface and expose the inflator (Fig 13).
2. Remove the empty CO<sub>2</sub> cylinder by firmly rotating the cylinder counterclockwise. Discard cylinder.
3. Remove grey cap by turning it counterclockwise.
4. Remove bobbin from cap or housing unit.

---

**NOTE: THE BOBBIN (YELLOW) MAY REMAIN IN THE CAP OR IN THE HOUSING ASSEMBLY WHEN YOU REMOVE THE CAP.**

---

5. Check the housing to be sure it is clear and dry. If necessary, rinse the inflator with fresh water to remove dirt and salt. Let dry.
6. Inspect the bobbin. Verify the bobbin is not past the printed expiration date (EX MM/YY) (Fig. 2). Confirm the bobbin is not used or damaged by verifying that no white material is missing - compare to a new one. If you are unsure of the bobbin's condition, replace it.
7. Bobbin must be installed into the housing (Fig. 13), white side up. By aligning the slots on the bobbin with the ridges inside the threaded housing the bobbin will slide in easily.
8. Install the grey cap by screwing clockwise until it meets the inflator housing shoulder.

---

**NOTE: NO GAP**

---

9. Check the new cylinder. Ensure that the CO<sub>2</sub> cylinder has not been pierced (Fig. 10).
10. Confirm the lever moves freely in the inflator housing (push up), then install a new cylinder by turning clockwise. Hand-tighten until snug.
11. Examine the status indicator (Fig. 13) and ensure it is GREEN. If the status indicator is red, the mechanism has been fired or is incorrectly fitted and the inflator requires service. Review re-arming instructions.

---

**THE STATUS INDICATOR MUST BE GREEN BEFORE PROCEEDING.**

---

12. Refold the PFD in accordance with the Repacking section (see "Repacking Your PFD" page 14).  
Your MD4042 Inflatable PFD is now ready for manual use with automatic back up.

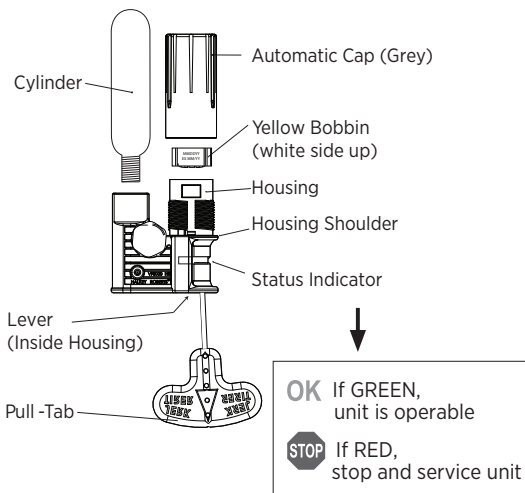

**FIGURE 13** MD4042 AUTOMATIC INFLATOR



## REPACKING

Repacking should only be done after deflating and re-arming the flotation device.

1. Fold sides (A) and (B) outward along dotted lines. Engage the Velcro™ strips (Fig. 14)
2. Make sure the inflator pull-tab hangs out from the bottom of the folded flotation device.

Fig. 15 depicts a correctly folded flotation device.

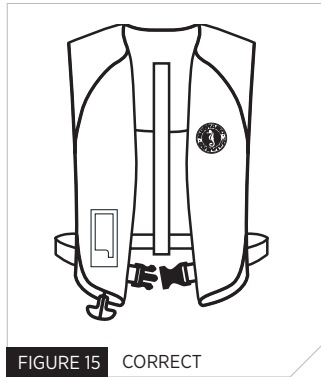
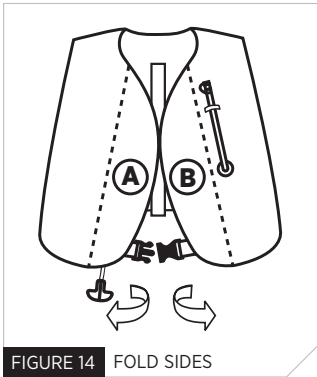

## IS YOUR FLOTATION DEVICE IN GOOD AND SERVICEABLE CONDITION?

Check your flotation device between outings to be sure that it is properly armed; that it is free of rips, tears, or holes; that all seams are securely sewn; and that the fabric, straps, and hardware are still strong. Inspect the inflatable portion of the flotation device in accordance with “Care and Maintenance Instructions,” next page.

## CARE AND MAINTENANCE INSTRUCTIONS

To ensure your flotation device performs when you need it, you must care for and maintain it in serviceable condition (see “Mandatory Carriage Requirements,” page 3). Failure to follow these instructions rigorously could result in a non-functioning flotation device causing injury or death. We suggest you keep a record of the inspections performed on your flotation device – using permanent ink on the Care and Storage label below the oral inflation tube. If you are not confident that you can care for and maintain your flotation device, or if you are in doubt about these instructions, contact Mustang Survival customer service.

You are required to check this flotation device:

- Before each wear (component inspection)
- Every six months (leak test and thorough visual examination)
- After each inflation (perform re-arm)
- Annually (suggested at the beginning of each boating season)

### BEFORE EACH WEAR

See “Inspecting Components,” page 4, for instructions. If you see any signs of damage, perform the “Every Six Months” tests below.

### EVERY SIX MONTHS

The following tests are suggested every six months at minimum or whenever you see signs of damage to your flotation device. Perform these tests more often if the flotation device is exposed to potential damage or used in extreme conditions.

- **Leak Test**

Orally inflate your flotation device until firm and let stand six hours minimum. As long as your flotation device has been inflated orally (not by CO<sub>2</sub> cylinder ) it should hold its firmness for this length of time. If this is not the case, your flotation device is leaking and should be replaced. If your flotation device leaks, contact Mustang Survival customer service.

- **Thorough Visual Examination**

See “Inspecting Components,” page 4.

## AFTER EACH INFLATION

Deflate and re-arm, as described in “Re-arming,” page 10 for MD4041 or page 12 for MD4042.

## ANNUALLY

Perform the following at the beginning of each boating season, after inflation, or whenever the integrity of the flotation device is in doubt:

1. Check all components for dirt or corrosion (see “Inspecting Components,” page 4). Clean or replace as necessary.
2. Visually examine your flotation device for damage or excessive abrasion, wear, tear, or contamination. Particular attention must be paid to the stitching, straps, and hardware. If in doubt, contact Mustang Survival customer service for evaluation and/or servicing.
3. Perform the Leak Test as outlined on previous page.
4. Deflate as outlined in “Deflating,” page 9.
5. Ensure service indicator is green.
6. Record the date, noting “annual” in permanent ink on the Care and Storage label, located beside the oral inflation tube.

## CLEANING AND STORING

To clean your flotation device:

- Hand wash flotation device or sponge it down in warm, soapy water, taking care not to expose the inflator to water.
- Rinse with clean water.
- Hang to dry on a plastic coat hanger.
- Store the dry flotation device in a warm, dry, and well ventilated place out of direct sunlight.

---

**DO NOT DRY-CLEAN, USE CHLORINE BLEACH, OR APPLY DIRECT HEAT.**

---

## HOW AND WHY TO TEST YOUR FLOTATION DEVICE

An inflatable flotation device does not have inherent buoyancy, meaning that it must be inflated to provide flotation. You must understand how to arm, inflate, and maintain your inflatable device. Familiarize yourself with the use of your inflatable so you know what to do in an emergency.

Always test your flotation device in a safe manner, under controlled conditions, and where help is readily available.

Inflate your flotation device and try it out in a pool, or some other calm protected water, with proper supervision.

### **Make sure it floats you**

- Comfortably (when worn properly)
- Adequately for expected wave conditions (body shapes/densities affect performance)

### **Make sure it works**

- A flow of bubbles should not appear (See “Care and Maintenance/Every Six Months,” page 15, for Leak Test)
- It should inflate quickly and easily

### **Learn how it works by**

- Activating the CO<sub>2</sub> inflation system
- Re-arming the CO<sub>2</sub> inflation system
- Using the oral inflation tube

To properly test your flotation device and to ensure you have a replacement re-arming kit, you should purchase two re-arming kits: one to be used immediately in testing the manual (for MD4041) or automatic (for MD4042) inflation system and the other to carry on board as a spare. Remember you must re-arm your flotation device after discharging the CO<sub>2</sub> cartridge.

**For MD4042**

You should test the automatic inflation system in the water at the beginning of each boating season. This includes inspecting the bobbin's expiration date and discarding if past the expiration date OR discarding if the element has been exposed to gas, oil, water, or high humidity. By doing this, you demonstrate that the automatic inflation system is still working properly and reduce the likelihood of premature inflation and its associated dangers.

**For Both MD4041 and MD4042**

Check the manual inflation system (with CO2 cylinder removed) to determine that the lever arm and piercing pin move freely when moving the lever (attached to the pull tab) several times (pull lever down and up for MD4041, push up lever for MD4042) determine that the lever arm moves freely. There should be no binding of the mechanical parts.

## TRYING YOUR FLOTATION DEVICE

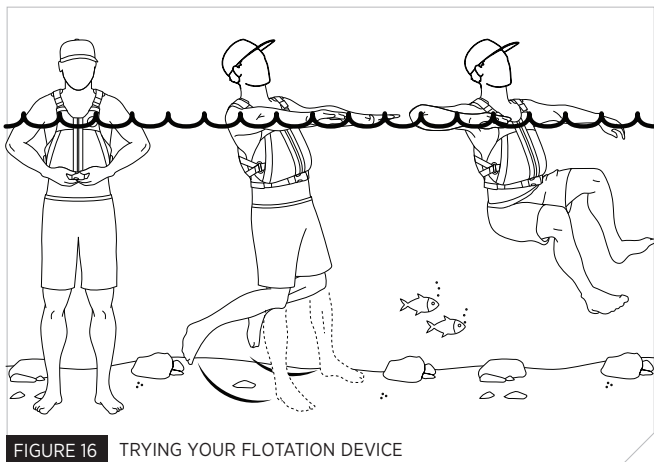

**FIGURE 16** TRYING YOUR FLOTATION DEVICE

Try on your flotation device to see if it fits comfortably snug. Then test it in shallow water to see how it handles. To check the buoyancy of your flotation device in the water, relax your body and let your head tilt back. Make sure your flotation device keeps your chin above water and you can breathe easily.

---

**BE AWARE: YOUR PFD MAY NOT ACT THE SAME IN SWIFT OR ROUGH WATER AS IN CALM WATER. THE CLOTHES YOU WEAR AND THE ITEMS IN YOUR POCKETS MAY ALSO CHANGE THE WAY YOUR FLOTATION DEVICE WORKS.**

---

If your mouth is not above the water, get a new flotation device or one with more buoyancy.

A flotation device is designed not to ride up on the body when in the water. But when a wearer's stomach is larger than the chest, ride-up may occur. Before use, test this flotation device in the water to establish that excessive ride-up does not impair performance.

In order to understand how your inflatable operates you should inflate it. Depending on the type of inflatable you have you can inflate it automatically, manually, or by the oral inflator. The following steps will guide you through each process.

## HOW TO TEST YOUR FLOTATION DEVICE USING THE AUTOMATIC INFLATOR (FOR MD4042 ONLY)

Always test your flotation device in a safe manner, under controlled conditions, where help is readily available.

- A1.** To test your flotation device, you will need:
  - your fully armed device
  - the re-arming kit approved for your device (MA4041)
- A2.** Put on the flotation device.
- A3.** Get into shallow water, just deep enough that you can stand with your head above the surface. Once the inflator is underwater, the flotation device should fully inflate automatically within 10 seconds.
- A4.** See if the flotation device will float you on your back or just slightly back of vertical. In a relaxed floating position, verify that your mouth is well above the water's surface. Note the effect of where you hold your legs on how you float.
- A5.** Get out of the water and remove the flotation device. Remove the used CO<sub>2</sub> cylinder and the used bobbin from the flotation device.
- A6.** Deflate the flotation device by depressing the oral inflation tube (see "Deflating," page 9).
- A7.** Let the flotation device dry thoroughly. Re-arm and repack the flotation device (see "Re-arming," page 12; see "Repacking," page 14).

## HOW TO TEST YOUR FLOTATION DEVICE USING THE MANUAL INFLATOR

Always test your flotation device in a safe manner, under controlled conditions, where help is readily available.

- M1.** To test your flotation device, you will need:
  - your fully armed flotation device
  - the re-arming kit approved for your device (MA4041)
- M2.** Put on the flotation device.
- M3.** Activate the inflation system by jerking firmly downward on the pull-tab. The flotation device should fully inflate within 5 seconds.
- M4.** Get into shallow water, just deep enough that you can stand with your head above the surface.
- M5.** See if the flotation device will float you on your back or just slightly back of vertical. In a relaxed floating position, verify that your mouth is well above the water's surface. Note the effect of where you hold your legs on how you float.
- M6.** Get out of the water and remove the flotation device. Remove the used CO<sub>2</sub> cylinder from the flotation device inflator. Completely deflate the flotation device using the oral inflator. (see "Deflating", page 9)
- M7.** Let the flotation device dry thoroughly. Rearm and repack the flotation device (see "Re-arming," page 10 for MD4041 or page 12 for MD4042; see "Repacking," page 14).



# HOW TO TEST YOUR FLOTATION DEVICE USING THE ORAL INFLATOR

Always test your flotation device in a safe manner, under controlled conditions, where help is readily available.

You will not need any spare parts, or re-arming kits, to test your inflatable flotation device with oral inflation, and it gives you the opportunity to learn about how much inflation is needed to float you.

01. Remove the CO<sub>2</sub> cylinder to prevent inadvertent inflation, which could potentially damage the flotation device. Inspect the cylinder to confirm it is unused (Fig. 12). Unscrew and remove the cap and the bobbin (for MD4042 only). Otherwise the bobbin will disintegrate during water immersion.
02. Put on flotation device. Locate and release the oral tube from its cover.
03. Get into shallow water, just deep enough that you can stand with your head above the surface.
04. To learn how much inflation is needed to float you, blow a full breath into the oral tube and then try lifting your feet from the bottom to see if your airway stays clear of the water. If not, try adding another breath and lifting your feet, and then another if needed and so forth so that you are supported well enough to be able to complete inflation without touching bottom or treading water. There may be situations where you wish to wear your device partially inflated (see “Using Your Device in Cold Temperatures,” page 5). However, when you are immersed in the water, your device must be fully inflated to function as designed and approved.
05. Remember: as your breath air cools down, it contracts in volume. You may require more topping up breaths to maintain this level. This level of inflation may also be useful in cold conditions where inflation could be delayed.
06. Then see if the turning characteristics of the flotation device are different with this level of flotation, as they most likely will be.
07. Fully inflate the flotation device using the oral inflator.
08. See if the flotation device will float you on your back or just slightly back of vertical. In a relaxed floating position, verify that your mouth is well above the water’s surface. Note the effect of where you hold your legs on how you float.
09. Get out of the water and remove the flotation device. Completely deflate the flotation device using the oral inflator (see “Deflating,” page 9).
010. Let the flotation device dry thoroughly. Rearm and Repack the flotation device (see “Re-arming,” page 10 for MD4041 or page 12 for MD4042; see “Repacking,” page 14).

## CHOOSE A FLOTATION DEVICE THAT YOU WILL WANT TO WEAR

A good choice for a flotation device is one that will offer sufficient buoyancy for your size and body type to raise your airway (mouth and nose) above water. Also important is comfort and mobility out of the water so that it can be worn at all times during your boating activity. An increased performance level (more flotation and turning) should be considered when in rougher waters or when further offshore where rescue assistance may be a long time coming. Some activities require special features or accessories for better visibility, for a more secure fit in wave conditions, and for thermal protection.

## COLD SHOCK

Unexpected immersion (even in moderately cold water) can cause involuntary gasping and loss of muscle control. It can take one minute or more for these reactions to subside, and there is a risk of inhaling water. You really need the support of a flotation device in this situation. In colder water, swim failure can occur even for strong and experienced swimmers. Trying to put on and fasten a flotation device after immersion can be impossible. Remember that on a hot sunny day the water can still be cool, and the effect of sudden immersion is shocking to the nervous and breathing systems. Choosing a comfortable device and being diligent about wearing it can save you in these critical first moments.

## HYPOTHERMIA

Prolonged immersion in cold water (after one hour or more) leads to a loss of body heat. Over time (depending on water temperature, body type, and thermal protection) the core temperature of the body decreases. This produces a condition called hypothermia, which is very serious and can lead to unconsciousness and circulatory failure.

Swimming and treading water accelerates heat loss. Wearing a flotation device is essential to help you conserve body energy and increase your survival time. It enables you to float quietly and curl up arms and legs in a Heat Escape Lessening Posture (HELP) with the head out of water, reducing heat loss from the head, under the arms, and the groin area (see “HELP,” Fig. 17). If there is more than one person in the water, gathering together in a huddle is recommended while waiting to be rescued (see “Huddle,” Fig. 17).

Preparation, good safety practices, and strong spirit are the keys to survival. Stay calm and don't give up.



FIGURE 17 HELP

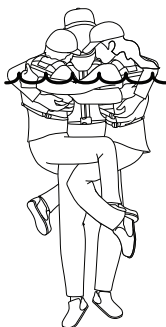

HUDDLE

## MAKE SURE YOUR DEVICE FUNCTIONS PROPERLY

For your flotation device to function properly, follow these suggestions to verify that it fits, floats, and remains in good condition.

1. Check the inflation mechanism status indicators before each use.
2. Get in the habit of re-arming the inflation mechanism right after each inflation.
3. Try your flotation device on and adjust it until it fits comfortably in and out of the water.
4. Mark your flotation device with your name if you are the only wearer.
5. Do not alter your flotation device. If it doesn't fit properly, get one that does. An altered device is no longer approved.
6. Your flotation device is not intended for use as a fender or kneeling pad.
7. If your flotation device is wet, allow it to dry thoroughly before storing it. Store it in a well-ventilated area.
8. Do not dry your flotation device in front of a radiator or other source of direct heat.

## ADDITIONAL INFORMATION

For information about lifejackets and boating safety consult:

**[www.wearitlifejacket.org](http://www.wearitlifejacket.org)**

US Coast Guard

**[www.uscgboating.org](http://www.uscgboating.org)**

Transport Canada

**<http://www.tc.gc.ca>**

Canadian Red Cross

**<http://canadian.redcross.ca/canadian-red-cross-society>**

American Red Cross

**<http://www.redcross.org>**

Canadian Safe Boating Council

**[www.csbc.ca](http://www.csbc.ca)**

National Safe Boating Council

**[www.safeboatingcouncil.org](http://www.safeboatingcouncil.org)**

US Power Squadrons

**<http://usps.org>**

Canadian Power and Sail Squadrons

**[www.cps-ecp.ca](http://www.cps-ecp.ca)**

## DO NOT ATTACH FLOTATION DEVICES TO YOUR BOAT

Each flotation device has straps, hooks, buckles, or other means for securing the device in place on the wearer. Some flotation devices also incorporate decorative D-rings or tabs. Such items are not to be used to attach the device to the boat. Attaching the device to the boat will not permit it to perform as intended.

# MUSTANG ENGINEERED

For 50 years Mustang Survival has been engineering high-performance marine gear for military, coast guard, and rescue personnel. With a focus on applied research and field-testing, we're committed to the protection and enhancement of those who push themselves to extremes. We build gear that saves lives and fuels exploration.

[www.mustangsurvival.com](http://www.mustangsurvival.com)

DO NOT REMOVE PRIOR TO SALE.

MUSTANG SURVIVAL AND SEA HORSE DESIGN ARE ALL REGISTERED TRADEMARKS OF MUSTANG SURVIVAL CORP.