

STANDARD HORIZON

Nothing takes to water like Standard Horizon

QUANTUM AIS GX6000

25 Watt VHF/FM Marine Transceiver

Owner's Manual

- Capable of connecting two optional wired RAM4 or one wired RAM4 and up to four Wireless RAM4W remote access microphones using SCU-30 wireless access point
- Integrated NMEA2000 interface supporting all PGNs for Navigation, GPS, AIS and DSC functions
- Integrated Dual Channel AIS (Automatic Identification System) receiver
- GPS Compass, Waypoint and GPS status pages
- Dual Zone 25W PA / Loud Hailer with preprogrammed horn, siren, fog signals and listen back
- Submersible IPX8 (5 feet or 1.5 meters for 30 minutes)
- Integrated 32 Code Voice Scrambler and 4 Code Voice Scrambler
- AIS / AIS SART target display: MMSI, Call Sign, Ship Name, BRG, DST, SOG and COG
- Front panel microphone can be connected to rear panel and extended 20 feet using MEK-4 mic extension kit
- Programmable CPA or TCPA collision avoidance alarms
- Advanced 80 dB commercial Grade Receiver with Local / Distance Attenuator
- Intercom feature allows you to communicate between the radio, RAM4 and Wireless RAM4W microphones
- Integrated Voice Recorder to play back up to two minutes of RX receive audio



TABLE OF CONTENTS

Quick Reference Guide	2	9 GPS OPERATION	47
1 GENERAL INFORMATION	3	9.1 DISPLAYING POSITION INFORMATION	47
2 PACKING LIST	4	9.2 CHECKING GPS STATUS	47
3 OPTIONAL ACCESSORIES	4	9.3 GPS LOGGER OPERATION	48
4 ONLINE WARRANTY REGISTRATION (in USA or Canada only) ...	4	10 DIGITAL SELECTIVE CALLING (DSC)	49
5 GETTING STARTED	5	10.1 GENERAL	49
5.1 PROHIBITED COMMUNICATIONS	5	10.2 DSC DISTRESS ALERT	50
5.2 ABOUT VHF RADIO	5	10.3 ALL SHIPS CALL	54
5.3 SELECTING AN ANTENNA	5	10.4 INDIVIDUAL CALL	56
5.4 COAXIAL CABLE	6	10.5 GROUP CALL	62
5.5 DISTRESS AND HAILING (CHANNEL 16)	6	10.6 POSITION REQUEST	67
5.6 CALLING ANOTHER VESSEL (CHANNEL 16 OR 9) ...	7	10.7 POSITION REPORT	71
5.7 MAKING TELEPHONE CALLS	8	10.8 POLLING CALL	75
5.8 BRIDGE CHANNELS 13 AND 67	8	10.9 AUTO POSITION POLLING	77
5.9 AUTOMATED RADIO CHECK SERVICE	8	10.10 DSC TEST	79
5.10 WHAT IS THE RANGE FOR AIS RECEIVERS?	9	10.11 DSC LOG OPERATION	81
5.11 Accuracy of COG*	9	10.12 DSC LOOP BACK OPERATION	83
6 CONTROLS AND INDICATORS	10	11 NAVIGATION	84
6.1 FRONT PANEL	10	11.1 WAYPOINT OPERATION	84
6.2 MICROPHONE	12	11.2 ROUTING OPERATION	88
6.3 REAR PANEL	14	12 GM OPERATION	92
7 INSTALLATION	16	12.1 SETTING UP GM OPERATION	92
7.1 SAFETY / WARNING INFORMATION	16	12.2 STARTING GM OPERATION	94
7.2 LOCATION	16	13 AUTOMATIC IDENTIFICATION SYSTEM (AIS) ...	96
7.3 MOUNTING THE RADIO	16	13.1 GENERAL	96
7.4 ELECTRICAL CONNECTIONS	18	13.2 AIS OPERATION	97
7.5 CONNECTION OF EXTERNAL DEVICES TO THE RADIO ...	19	13.3 AIS SETUP	100
7.6 INITIAL SETUP REQUIRED WHEN TURNING ON THE POWER FOR THE FIRST TIME ...	26	14 NMEA 2000 SETUP	102
7.7 CHECKING GPS SIGNAL (GPS STATUS DISPLAY) ...	28	14.1 SELECT DEVICE	102
7.8 GPS CONFIGURATION	29	14.2 DEVICE NUMBER	102
8 BASIC OPERATION	32	14.3 SYSTEM NUMBER	103
8.1 TURNING ON AND OFF THE TRANSCEIVER	32	14.4 SUMMARY OF THE NMEA 2000 SETUP	103
8.2 RECEPTION	32	14.5 COMPATIBLE NMEA 2000 PGN LIST	103
8.3 TRANSMISSION	32	15 CONFIGURATION SETUP	105
8.4 BASIC OPERATION OF THE MENU MODE	33	15.1 DISPLAY MODE	105
8.5 TRANSMIT TIME-OUT TIMER (TOT)	34	15.2 DIMMER ADJUSTMENT	105
8.6 SIMPLEX/DUPLEX CHANNEL USE	34	15.3 DISPLAY CONTRAST	105
8.7 USA, INTERNATIONAL, AND CANADA MODE	35	15.4 KEY BEEP	106
8.8 NOAA WEATHER CHANNELS	35	15.5 FOG ALERT TONE FREQUENCY	106
8.9 MULTI WATCH (TO PRIORITY CHANNEL)	37	15.6 LISTEN BACK	106
8.10 SCANNING	38	15.7 STATION NAME	107
8.11 PRESET CHANNELS: INSTANT ACCESS	40	15.8 SOFT KEYS	108
8.12 MOB OPERATION	41	15.9 RESET	110
8.13 PA/FOG OPERATION	42	15.10 SUMMARY OF THE CONFIGURATION SETUP	110
8.14 INTERCOM OPERATION	45	16 CHANNEL FUNCTION SETUP	111
8.15 VOICE SCRAMBLER	45	16.1 CHANNEL GROUP	111
8.16 DEMO MODE	46	16.2 WEATHER ALERT	111
		16.3 SCAN MEMORY	111
		16.4 SCAN TYPE	111
		16.5 SCAN RESUME	111

TABLE OF CONTENTS

16.6	MULTI WATCH	112	24.3	RECEIVER (for Voice and DSC)	147
16.7	PRIORITY CHANNEL	112	24.4	RECEIVER (for AIS)	148
16.8	SUB CHANNEL	112	24.5	NMEA INPUT/OUTPUT	148
16.9	CHANNEL NAME	112	24.6	SCU-31 EXTERNAL GPS ANTENNA (Optional)	148
16.10	NOISE CANCELLATION	113	24.7	DIMENSIONS	149
16.11	AUDIO FILTER OPERATION	114	25	FCC RADIO LICENSE INFORMATION	150
16.12	RX RECORDER	114	25.1	STATION LICENSE	150
16.13	SCRAMBLER SETUP	116	25.2	RADIO CALL SIGN	150
16.14	SUMMARY OF THE CHANNEL FUNCTION SETUP	117	25.3	CANADIAN SHIP STATION LICENSING	150
17	DSC SETUP	118	25.4	FCC / INDUSTRY CANADA INFORMATION	150
17.1	INDIVIDUAL DIRECTORY	118	26	FCC NOTICE	151
17.2	INDIVIDUAL REPLY	118	TEMPLATE for the GX6000		153
17.3	INDIVIDUAL ACKNOWLEDGMENT	118			
17.4	INDIVIDUAL RINGER	118			
17.5	GROUP DIRECTORY	118			
17.6	POSITION REPLY	119			
17.7	AUTO POSITION POLLING	119			
17.8	AUTO POSITION INTERVAL	119			
17.9	AUTO CHANNEL CHANGE	119			
17.10	NO ACTION TIMER	120			
17.11	WAIT TIME FOR POSITION FIX	120			
17.12	DSC BEEP	120			
17.13	SUMMARY OF THE DSC SETUP MENU	120			
18	GPS SETUP	122			
18.1	ORDER OF PRIORITY	122			
18.2	COMPASS DIRECTION	122			
18.3	LOCATION FORMAT	122			
18.4	TIME OFFSET	123			
18.5	TIME AREA	123			
18.6	TIME FORMAT	123			
18.7	UNITS OF MEASURE	123			
18.8	MAGNETIC VARIATION	123			
18.9	NMEA 0183 IN/OUT	124			
18.10	Position Data Output	125			
18.11	OPTION GPS UNIT	126			
18.12	SUMMARY OF THE GPS SETUP	128			
19	SSM-70H (RAM4) REMOTE MIC OPERATION ...	130			
19.1	REMOTE MIC CONTROLS	130			
19.2	RAM4 SOFT KEY ASSIGNMENT	132			
20	CONNECTING A USB DATA TERMINAL				
	TO THE PC ...	134			
21	MAINTENANCE	135			
21.1	REPLACEMENT PARTS	135			
21.2	FACTORY SERVICE	136			
21.3	TROUBLESHOOTING CHART	137			
22	CHANNEL ASSIGNMENTS	138			
23	WARRANTY	144			
24	SPECIFICATIONS	147			
24.1	GENERAL	147			
24.2	TRANSMITTER	147			

QUICK REFERENCE GUIDE

The **GX6000** is equipped with the E2O (Easy-To-Operate) menu system. Basic operation may be accomplished by following the procedure below:

- ① Press and hold the **⏻** key to turn on or off the radio.
- ② The **MODE/STATUS** indicator indicates the status of the transceiver.
- ③ Rotate the **SQL** knob clockwise to squelch or counterclockwise to un-squelch the radio.
- ④ Rotate the **VOL** knob to adjust the speaker audio volume.
- ⑤ Press the **MENU** key to access MENU.
- ⑥ Press the **16/S** key on the radio or the microphone to select channel 16. Press and hold the **16/S** key on the radio or the microphone to select sub channel. Press again to revert to the last selected channel.
- ⑦ Activates a DSC distress call. Lift the red cover, press the **DISTRESS** once, then press and hold until the radio alarms.
- ⑧ These three programmable soft keys can be customized through the setup menu to quickly access advanced functions of the radio. Press the **▶/◀** key to switch the function of these keys, display the key functions at the bottom of the display.
- ⑨ Press the **▲/▼** key (or press the microphone's **▲/▼** keys) to select the operating channel. While the MENU screen is displayed, press the key to slide the on-screen menu upward/downward.
- ⑩ Press the **▶/◀** key to switch the function menu. While the MENU screen is displayed, press the key to slide the on-screen menu to the right/left side.
- ⑪ Press the **CLEAR** key to cancel a function or menu selection.
- ⑫ While the normal screen is displayed, rotate the **DIAL/ENT** knob to select your desired channel. While the MENU screen is displayed, rotate the knob to select your desired menu item.
- ⑬ To transmit: place your mouth about 1/2 inch away from Mic hole and speak in a normal voice level while pressing the **PTT** switch.
- ⑭ Press the **H/L** key to toggle the transmit power between High (25W) and Low (1W).

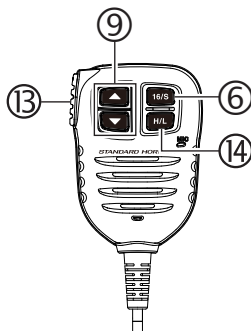
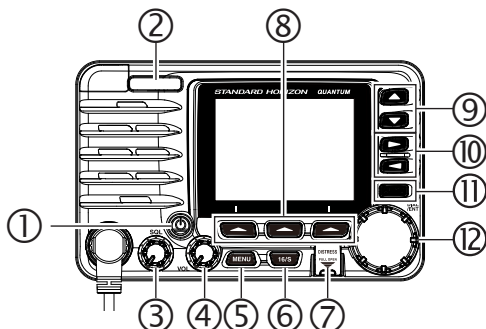

1 GENERAL INFORMATION

The STANDARD HORIZON **GX6000** Marine VHF/FM Marine transceiver is designed to be used in USA, International, and Canadian Marine bands. The **GX6000** can be operated from 11 to 16 VDC and has a switchable RF output power of 1 watt or 25 watts.

The **GX6000** integrates a dual channel AIS (Automatic Identification System) receiver to display class A and B AIS vessel information (MMSI, Call Sign, Ship Name, BRG, DST, SOG and COG) directly on the LCD display. The **GX6000** has a separate AIS antenna connection to ensure that you will be able to receive AIS signals while transmitting VHF communications. The **GX6000** is also capable of entering and saving up to 250 waypoints, which may be selected and navigated to by using a unique navigation compass display. The **GX6000** allows you to contact an AIS ship directly using DSC, show your vessels position in relation to AIS targets and alert you when an AIS ship may be approaching too close to your location via the Closest Point of Approach (CPA) Alarm or Time to Closest Point of Approach (TCPA) Alarm.

The **GX6000** is capable of DSC (Digital Selective Calling) ITU-R M.493 Class D operation. Class D operation allows continuous receiving of Digital Selective Calling functions on channel 70 even if the radio is receiving a call. The **GX6000** operates on all currently-allocated marine channels which are switchable for use with USA, International, or Canadian regulations. Emergency channel 16 can be immediately selected from any channel by pressing the red **16/S** key. NOAA weather channel can also be accessed immediately by pressing the **[WX]** soft key.

Other features of the **GX6000** includes: Noise canceling function for transmit and receive audio, NMEA 2000 compatibility, high expandability, integrated voice recorder to play back up to two minutes of RX receive audio, speaker microphone, dual zone 25 W PA/Loud hailer with preprogrammed fog signals and listen back, capable of being connected to two optional wired **RAM4** or one wired **RAM4** and four Wireless **RAM4W**^{*1} remote access microphones, allowing full control of all VHF, DSC and hailer functions remotely including an intercom feature allowing you to communicate between the radio, **RAM4** and Wireless **RAM4W** microphones, scanning, priority scanning, submersible speaker microphone, high and low voltage warning, and GPS repeatability. (*1 requires SCU-30 Wireless Access Port)

2 PACKING LIST

When the package containing the transceiver is first opened, please check it for the following contents:

- Transceiver **GX6000**
- Speaker Microphone
- DC Power Cord
- Mounting Bracket and Hardware
- Owner's Manual
- DSC Warning Sticker
- USB Cable (Type USB "A" plug to Type USB micro "B" plug) **T9101606**

3 OPTIONAL ACCESSORIES

Flush-Mount Bracket	MMB-84
Remote-Access Microphone (RAM4 Mic)	SSM-70H
RAM4W Wireless Remote Access Microphone	SSM-71H
Wireless Access Point	SCU-30
23 Feet Extension Cable for SSM-70H (RAM4) Microphone	CT-100
20 Feet Microphone Extension Kit (for connection to rear panel) ...	MEK-4
External Loud Speaker	MLS-300
5" Round 30 Watt Hail/PA Horn	220SW
5" × 8" Rectangular 40 Watt Hail/PA Horn	240SW
External GPS Antenna with 49 Feet of Cable	SCU-31

4 ONLINE WARRANTY REGISTRATION (in USA or Canada only)

Please visit www.standardhorizon.com to register the **GX6000** Marine VHF. It should be noted that visiting the website from time to time may be beneficial to you, as new products are released they will appear on the STANDARD HORIZON website.

PRODUCT SUPPORT INQUIRIES

If you have any questions or comments regarding the use of the **GX6000**, you can visit the STANDARD HORIZON website to send an E-Mail or contact the Product Support team at (800) 767-2450 M-F 8:00-5:00 PST.

5 GETTING STARTED

5.1 PROHIBITED COMMUNICATIONS

The FCC prohibits the following communications:

- False distress or emergency messages;
- Messages to “any boat” except in emergencies and radio tests;
- Messages to or from a vessel on land;
- Transmission while on land;
- Obscene, indecent, or profane language (potential fine of \$10,000).

5.2 ABOUT VHF RADIO

The radio frequencies used in the VHF marine band lie between 156 and 158 MHz with some shore stations available between 161 and 163 MHz. The marine VHF band provides communications over distances that are essentially “line of sight” (VHF signals do not travel well through objects such as buildings, hills or trees). Actual transmission range depends much more on antenna type, gain and height than on the power output of the transmitter. On a fixed mount 25 W radio transmission expected distances can be greater than 15 miles, for a portable 5 W radio transmission the expected distance can be greater than 5 miles in “line of sight”.

5.3 SELECTING AN ANTENNA

Marine antennas are made to radiate signals equally in all horizontal directions, but not straight up. The objective of a marine antenna is to enhance the signal toward the horizon. The degree to which this is accomplished is called the antenna’s gain. It is measured in decibels (dB) and is one of the major factors in choosing an antenna. In terms of effective radiated power (ERP), antennas are rated on the basis of how much gain they have over a theoretical antenna with zero gain. A 3-foot, 3 dB gain antenna represents twice as much gain over the imaginary antenna.

Typically, a 3-foot 3 dB gain stainless steel whip is used on a sailboat mast. The longer 8-foot 6 dB fiberglass whip is primarily used on power boats that require the additional gain.

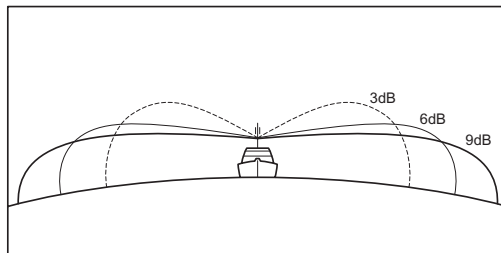

5.4 COAXIAL CABLE

VHF antennas are connected to the transceiver by means of a coaxial cable – a shielded transmission line. Coaxial cable is specified by its diameter and construction.

For runs less than 20 feet, RG-58/U, about 1/4 inch in diameter is a good choice. For runs over 20 feet but less than 50 feet, the larger RG-8X or RG-213/U should be used for cable runs over 50 feet RG-8X should be used. For installation of the connector onto the coaxial cable refer to the figure below.

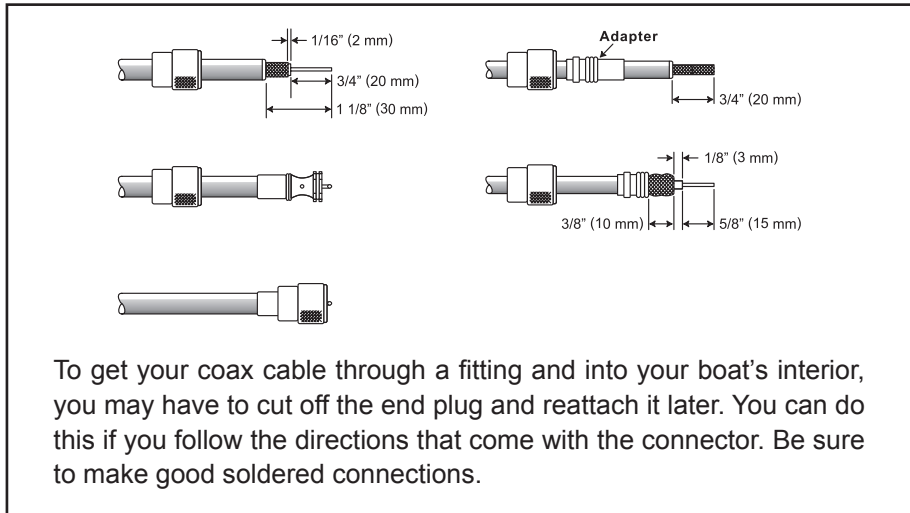

5.5 DISTRESS AND HAILING (CHANNEL 16)

Channel 16 is known as the Hail and Distress Channel. An emergency may be defined as a threat to life or property. In such instances, be sure the transceiver is on and set to CHANNEL 16. Then use the following procedure:

1. Press the microphone push-to-talk switch and say "**Mayday, Mayday, Mayday**. This is _____, _____, _____" (your vessel's name).
2. Then repeat once: "**Mayday, _____**" (your vessel's name).
3. Now report your position in latitude/longitude, or by giving a true or magnetic bearing (state which) to a well-known landmark such as a navigation aid or geographic feature such as an island or harbor entry.
4. Explain the nature of your distress (sinking, collision, aground, fire, heart attack, life-threatening injury, etc.).
5. State the kind of assistance your desire (pumps, medical aid, etc.).
6. Report the number of persons aboard and condition of any injured.
7. Estimate the present seaworthiness and condition of your vessel.

8. Give your vessel's description: length, design (power or sail), color and other distinguishing marks. The total transmission should not exceed 1 minute.
9. End the message by saying "**OVER**". Release the microphone switch and listen.
10. If there is no answer, repeat the above procedure. If there is still no response, try another channel.

NOTE

The **GX6000** has the DSC Distress calling, that can transmit a distress call digitally to all ships with compatible DSC radios. Refer to section "**10 DIGITAL SELECTIVE CALLING (DSC)**".

5.6 CALLING ANOTHER VESSEL (CHANNEL 16 OR 9)

Channel 16 may be used for initial contact (hailing) with another vessel. However, its most important use is for emergency messages. This channel must be monitored at all times except when actually using another channel.

It is monitored by the U.S. and Canadian Coast Guards and by other vessels. **Use of channel 16 for hailing must be limited to initial contact only.** Calling should not exceed 30 seconds, but may be repeated 3 times at 2-minute intervals. In areas of heavy radio traffic, congestion on channel 16 resulting from its use as a hailing channel can be reduced significantly in U.S. waters by using **channel 9** as the initial contact (hailing) channel for non-emergency communications. Here, also, calling time should not exceed 30 seconds but may be repeated 3 times at 2-minute intervals.

Prior to making contact with another vessel, refer to the channel charts in this manual, and select an appropriate channel for communications after initial contact. For example, Channels 68 and 69 of the U.S. VHF Charts are some of the channels available to non-commercial (recreational) boaters. Monitor your desired channel in advance to make sure you will not be interrupting other traffic, and then go back to either channel 16 or 9 for your initial contact.

When the hailing channel (16 or 9) is clear, press the **PTT** switch on the mic and state the name of the other vessel you wish to call and then "this is" followed by the name of your vessel and your Station License (Call Sign) then release the **PTT** switch on the mic. When the other vessel returns your call, immediately request another channel by pressing the **PTT** switch on the mic and saying "**go to,**" the number of the other channel, say "**over**" and release the **PTT** switch on the mic. Then switch to the new channel. When the new channel is not busy, call the other vessel.

After a transmission, say “**over**,” and release the microphone’s push-to-talk (PTT) switch. When all communication with the other vessel is completed, end the last transmission by stating your Call Sign and the word “**out**.” Note that it is not necessary to state your Call Sign with each transmission, only at the beginning and end of the contact.

Remember to return to Channel 16 when not using another channel. Some radios automatically monitor Channel 16 even when set to other channels or when scanning.

5.7 MAKING TELEPHONE CALLS

To make a radiotelephone call, use a channel designated for this purpose. The fastest way to learn which channels are used for radiotelephone traffic is to ask at a local marina. Channels available for such traffic are designated **Public Correspondence** channels on the channel charts in this manual. Some examples for USA use are Channels 24, 25, 26, 27, 28, 84, 85, 86, and 87. Call the marine operator and identify yourself by your vessel’s name. The marine operator will then ask you how you will pay for the call (telephone credit card, collect, etc.) and then link your radio transmission to the telephone lines.

The marine telephone company managing the VHF channel you are using may charge a link-up fee in addition to the cost of the call.

5.8 BRIDGE CHANNELS 13 AND 67

Channel 13 is used at docks, bridges and by vessels maneuvering in port. Messages on this channel must concern navigation only, such as meeting and passing in restricted waters.

Channel 67 is used for navigational traffic between vessels.

By regulation, power is normally limited to 1 Watt on these channels. Your radio is programmed to automatically reduce power to this limit on these channels. However, in certain situations it may be necessary to temporarily use a higher power. See Page 33 for means to temporarily override the low-power limit on these two channels.

5.9 AUTOMATED RADIO CHECK SERVICE

In areas across the country, Sea Tow offers boaters a way to conduct radio checks. To use Sea Tow’s free Automated Radio Check service, simply tune your VHF radio to the appropriate channel for your location and conduct a radio check as you typically would. Upon releasing your radio’s microphone, the system will play an automated message and relay your transmission back to you, thereby letting you know how your signal will sound to other boaters.

The Automated Radio Check Service is currently available in the areas listed below.

West Coast	Sea Tow Newport/LA - Ch. 27 Sea Tow San Diego - Ch. 27
Northeast	Sea Tow Portland-Midcoast (Maine) - Ch. 27 Sea Tow Boston - Ch. 27 Sea Tow South Shore (Mass.) - Ch. 28 Sea Tow Rhode Island - Ch. 24 Sea Tow Eastern Long Island - Ch. 27 Sea Tow Huntington (N.Y.) - Ch. 27 Sea Tow Manasquan (N.J.) - Ch. 28
Mid-Atlantic	Sea Tow Northern Chesapeake (Md.) - Ch. 28 Sea Tow Central Chesapeake (Md.) - Ch. 27 Sea Tow Hampton Roads (Va.) - Ch. 28
North Carolina	Sea Tow Wrightsville Beach - Ch. 28 Sea Tow Ocean Isle Beach - Ch. 28
Florida	Sea Tow Sebastian - Ch. 28 Sea Tow Fort Lauderdale - Ch. 27 Sea Tow Charlotte Harbor - Ch. 24 Sea Tow Tampa Bay - Ch. 27 Sea Tow Horseshoe Beach - Ch. 27 Sea Tow Carrabelle/St. Marks - Ch. 27 Sea Tow Pensacola/Orange Beach (Ala.) - Ch. 27

5.10 WHAT IS THE RANGE FOR AIS RECEIVERS?

Since AIS uses similar frequencies as a marine VHF radio, it has similar radio reception capabilities - which are basically line of sight. This means that the higher the VHF antenna is mounted, the greater the reception area will be. Reception from Class A vessels that are 20 or even 30 miles away on open water is not uncommon as their antennas are mounted high off the water. Class B transponders use lower power for transmissions; therefore, you can expect Class B vessels to be acquired when they are 5 to 10 miles away.

NOTE

The GX6000 require two separate marine VHF antennas; one antenna for VHF and a second antenna for AIS.

For additional information on AIS visit the USCG website:
<<http://www.navcen.uscg.gov/marcomms/ais.htm>>

5.11 Accuracy of COG*

The error in the COG (the path of the antenna position over ground) due to the actual ship's speed over ground shall not exceed the following values:

Speed range (knots)	Accuracy of COG output to user
0 to ≤1 knot	Unreliable or not available
>1 to ≤17 knots	±3°
>17 knots	±1°

* Only when the SCU-31 external GPS antenna connected.

6 CONTROLS AND INDICATORS

This section defines each control of the transceiver. See illustration below for location of controls. For detailed operating instructions refer to chapter 8 of this manual.

6.1 FRONT PANEL

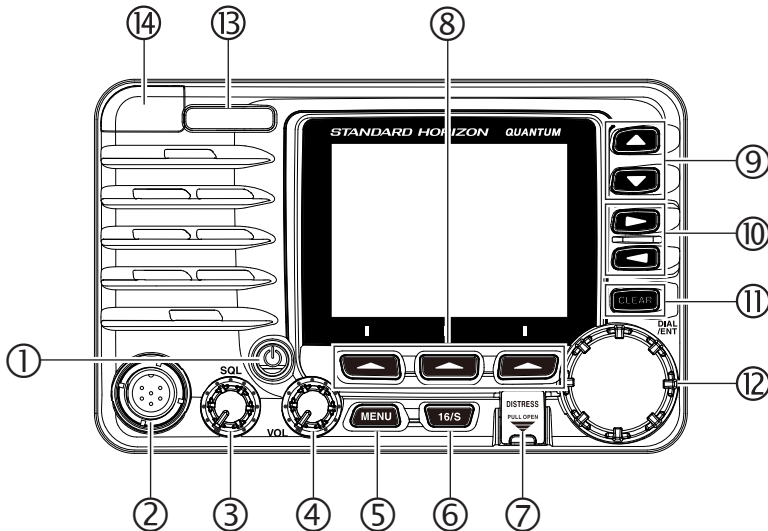

① **Power** key

Press and hold to toggle the radio on or off. When the power is turned on, the transceiver is set to the last selected channel.

② **MIC Connector**

Connects the supplied speaker microphone.

③ **SQL knob** (Squelch control)

Adjusting this control clockwise, sets the point at which random noise on the channel does not activate the audio circuits but a received signal does. This point is called the squelch threshold. Further adjustment of the squelch control will degrade reception of wanted transmissions.

④ **VOL knob** (Volume control)

Adjusts the audio volume level.

Clockwise rotation of this knob increases the internal and speaker microphone volume.

SECONDARY USE

When in the PA or Fog mode, controls the listen-back volume.

⑤ **MENU** key

Press to access MENU. For details, refer to section “**8.4 BASIC OPERATION OF THE MENU MODE**”.

⑥ **16/S** key

Pressing this key immediately recalls channel 16 from any channel location. Holding down this key selects the SUB channel (The default setting is channel 9). Pressing this key again reverts to the previous selected working channel.

⑦ **DISTRESS** key

Used to send a DSC Distress Call. To send the distress call, refer to section “**10.2.1 Transmitting a DSC Distress Alert**”.

⑧ Soft keys

The 3 programmable soft keys can be customized by the Setup Menu mode described in section “**15.8 SOFT KEYS**”.

⑨ ▲/▼ key

These keys are used to change the operating channel. The Up/Down keys on the microphone can also be used to change the operating channel. Press the key momentarily, the channel increases/decreases one step. Holding the key, the channel increases/decreases continuously.

SECONDARY USE

- While the MENU screen is displayed, press the key to slide the on-screen menu upward/downward.

⑩ ►/◄ key

Press these keys to switch the function of soft keys.

SECONDARY USE

While the MENU screen is displayed, press the key to slide the on-screen menu to the right/left side.

⑪ **CLEAR** key

Press this key to cancel a menu selection.

⑫ **DIAL/ENT** knob

While the normal screen is displayed, rotate the **DIAL/ENT** knob to select your desired channel. While the MENU screen is displayed, rotate the knob to select your desired menu item.

SECONDARY USE

- Press this knob to enter a selection in the MENU.

⑬ MODE/STATUS indicator

Indicates the radio status with the four colors on the three positions of the mode/status indicator.

Position	Color	Description
Left	Blue	AIS-Board Working
	Purple	Receiving MSG23
	Red	AIS-Board Failed
Right	Green	AIS Receiving (registered MMSI)
	Orange	AIS Receiving (unregistered MMSI)
	Red	Receive Error

⑭ DATA jack

Use the USB micro type B jack to configure the transceiver settings and download* the GPS logger data. (* An optional SCU-31 GPS External GPS Antenna is required.)

Note: When the DATA jack is securely covered with rubber cap, the **GX6000** meets the waterproofing performance.

6.2 MICROPHONE

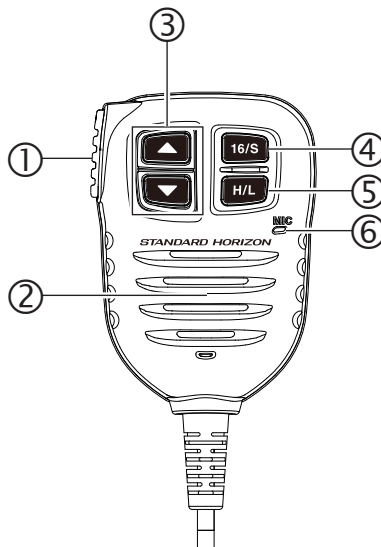

① PTT (Push-To-Talk) switch

When in radio mode and the **PTT** switch is pressed, the transmitter is enabled for voice communications to another vessel.

When PA mode is selected, pressing the **PTT** switch allows your voice to be amplified and supplied to a connected PA horn.

When an optional **RAM4** and **RAM4W** mic is connected and intercom mode is selected, pressing the **PTT** switch enables voice communications from the **GX6000** to the **RAM4** and **RAM4W** second station microphone.

② Microphone speaker

Audio heard through internal radio speaker is heard through the speaker microphone.

③ ▲/▼ key

These keys on the microphone are used to select channels and to choose menu items.

④ **16/S** key

Pressing this key immediately selects channel 16 from any channel location. Holding down this key selects the SUB channel (The default setting is channel 9). Pressing this key again reverts to the previous selected working channel.

⑤ **H/L** key

Press this key to toggle between 25 W (High) and 1 W (Low) power. When the TX output power is set to “Low” while the transceiver is on channel 13 or 67, the output power will temporarily switch from “Low” to “High” power until the **PTT** switch of the microphone is released. This key is not available on transmit inhibited and low power only channels.

⑥ Microphone

The internal microphone transmits your voice reducing background noise using Clear Voice Noise Reduction Technology.

Note: Position your mouth about 1/2” (1.5 cm) away from the microphone hole and speak in a normal voice.

6.3 REAR PANEL

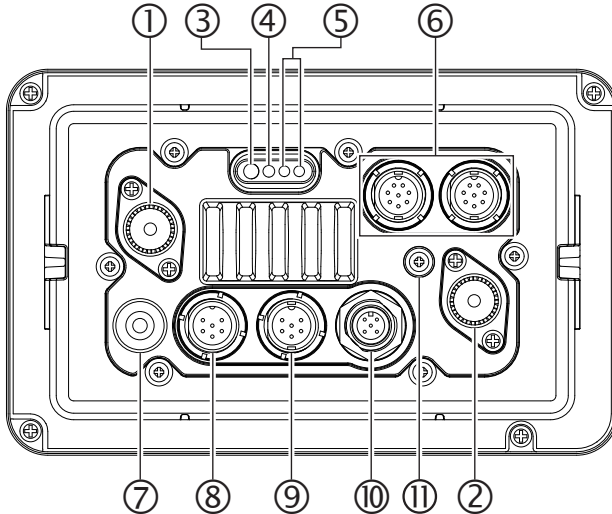

- ① **VHF ANT** jack (VHF antenna jack)
Connects an antenna to the transceiver. Use a marine VHF antenna with an impedance of 50 ohms.
Note: This **ANT** jack is used to marine voice channel.
- ② **AIS ANT** jack (AIS antenna jack)
Connects an antenna to the AIS receiver. Use a marine VHF antenna with an impedance of 50 ohms.
- ③ **PA Speaker Connection Cable** (Orange, Yellow, Green & Blue)
Connects the **GX6000** to PA speakers. See section “**3 OPTIONAL ACCESSORIES**” for a list of optional **STANDARD HORIZON** Speakers.
Green: PA1 Speaker (+)
Blue: PA1 Speaker (-)
Orange: PA2 Speaker (+)
Yellow: PA2 Speaker (-)
- ④ **EXTERNAL Speaker Connection Cable** (Red & White)
Connects the **GX6000** to an optional external speaker. Refer to section “**3 OPTIONAL ACCESSORIES**” for a list of optional **STANDARD HORIZON** Speakers.
Red: External Speaker (+)
White: External Speaker (-)
- ⑤ **DC Input Cable**
Connects the radio to a DC power supply capable of delivering 11 to 16 VDC.

- ⑥ **RAM-1* / RAM-2** Remote Access Microphone Connectors
Connects the **GX6000** to the **SSM-70H (RAM4)** Remote Station Microphone or SCU-30 Wireless Access Point* for use with up to four SSM-71H (RAM4W) wireless microphones. Refer to section “**19 SSM-70H (RAM4) REMOTE MIC OPERATION**” for details. (* The SCU-30 Wireless Access Point may be connected only to the RAM-1 connector.)
- ⑦ NMEA 0183 In/Out & NMEA 0183-HS OUT Connection Cable (Blue, Green, Gray, Brown, Yellow & White)
Connects the **GX6000** to a GPS chart plotter. Refer to section “**7.5 CONNECTION OF EXTERNAL DEVICES TO THE RADIO**”.
- ⑧ Rear MIC Connector
Connects the supplied hand microphone if desired. This connector provides the same function as that on the front panel and allows remote use of the microphone by using the optional **MEK-4** (microphone extension kit).
- ⑨ GPS ANT Connector (White)
Connects the optional **SCU-31** external GPS antenna.
- ⑩ NMEA 2000 Connector (Black)
Connects to the NMEA 2000 network.
- ⑪ **GND** Terminal (Ground Terminal)
Connects the **GX6000** to ships ground, for safe and optimum performance. Use the screw supplied with the **GX6000** only.

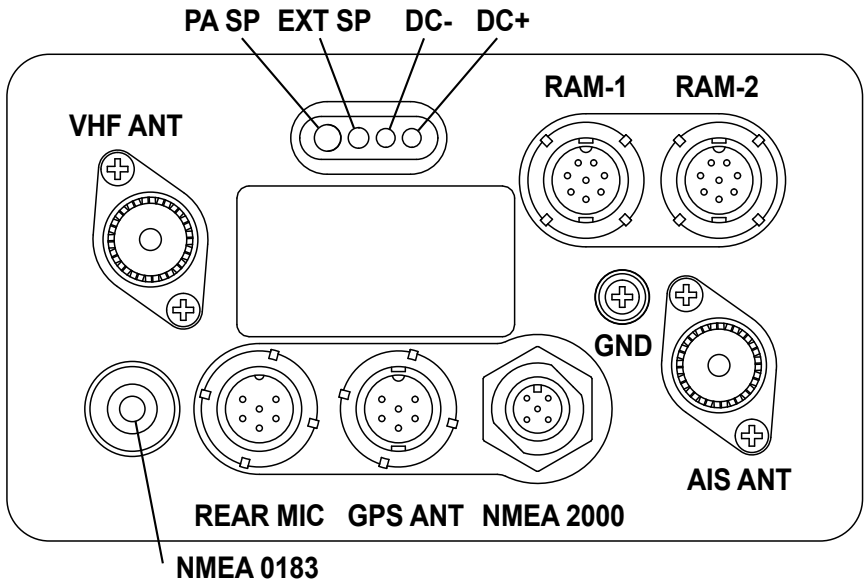

7 INSTALLATION

7.1 SAFETY / WARNING INFORMATION

This radio is restricted to occupational use, work related operations only where the radio operator must have the knowledge to control the exposure conditions of its passengers and bystanders by maintaining the minimum separation distance of 3 feet (1 m). Failure to observe these restrictions will result in exceeding the FCC RF exposure limits.

Antenna Installation:

The antenna must be located at least 3 feet (1 m) away from passengers in order to comply with the FCC RF exposure requirements.

7.2 LOCATION

The radio can be mounted at any angle. Choose a mounting location that:

- complies with the compass safe distances shown in the table below to prevent interference to a magnetic compass

Transceiver Unit	1.0 m
Handset	0.5 m

- provides accessibility to the front panel controls
- allows connection to a power source and antennas
- has nearby space for installation of a microphone hanger
- is at least 3 feet (1 m) away from the radio's antenna
- the signal from the GPS satellite can receive sufficiently

Note: To insure the radio does not affect the compass or radios performance is not affected by the antenna location, temporarily connect the radio in the desired location and:

- a. Examine the compass to see if the radio causes any deviation
- b. Connect the antenna and key the radio. Check to ensure the radio is operating correctly by requesting a radio check.

7.3 MOUNTING THE RADIO

7.3.1 Supplied Mounting Bracket

The supplied mounting bracket allows overhead or desktop mounting.

Use a 13/64" (5.2 mm) bit to drill the holes to a surface which is more 0.4" (10 mm) thick and can support more than 3.3 lbs (1.5 kg) and secure the bracket with the supplied screws, spring washers, flat washers, and nuts.

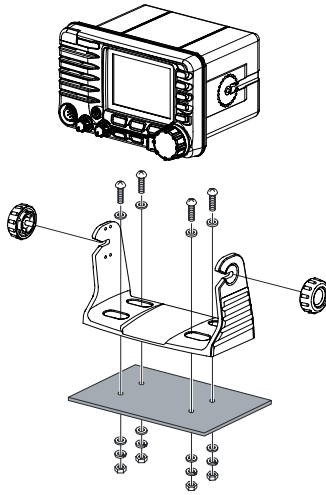

Desktop Mounting

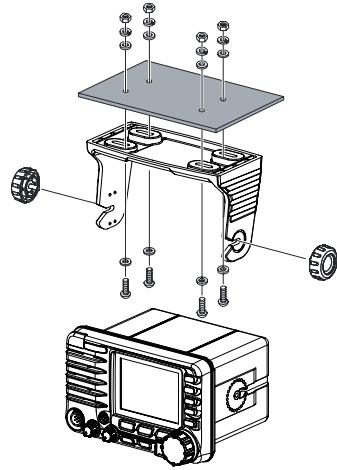

Overhead Mounting

7.3.2 Optional MMB-84 Flush Mount Bracket

1. Use the template (page 153) to mark the location where the rectangular hole is to be cut. Confirm the space behind the dash or panel is deep enough to accommodate the transceiver (at least 6.7" (17 cm) deep). There should be at least 1/2" (1.3 cm) between the transceivers heatsink and any wiring, cables or structures.
2. Cut out the rectangular hole and insert the transceiver.
3. Fasten the brackets to the sides of the transceiver with the lock washer screw combination; so that the mounting screw base faces the mounting surface (see illustration below).
4. Turn the adjusting screw to adjust the tension so that the transceiver is tight against the mounting surface.

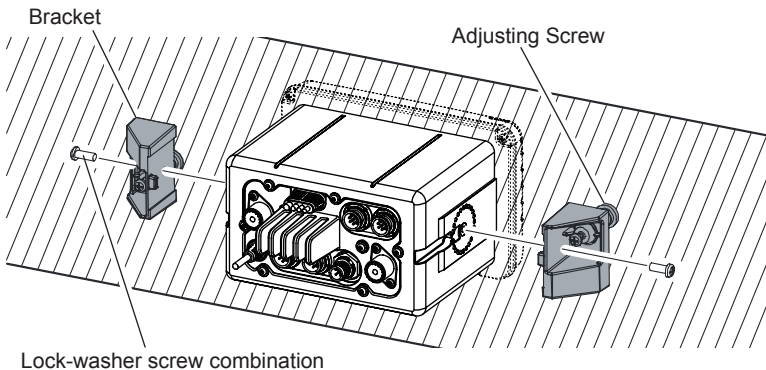

7.4 ELECTRICAL CONNECTIONS

CAUTION

Reverse polarity battery connections will damage the radio!

Connect the power cord and antenna to the radio. Antenna and Power Supply connections are as follows:

1. Mount the antenna at least 3 feet (1 m) away from the radio. At the rear of the radio, connect the antenna cable. The antenna cable must have a PL259 connector attached. RG-8/U coaxial cable must be used if the antenna is 25 feet (7.6 m) or more from the radio. RG58 cable can be used for distances less than 25 feet (7.6 m).
2. Connect the red power wire to a 13.8 VDC $\pm 20\%$ power source. Connect the black power wire to a negative ground.
3. If an optional remote extension speaker is is to be used, refer to section 6.5 for connections.
4. It is advisable to have a Certified Marine Technician check the power output and the standing wave ratio of the antenna after installation.

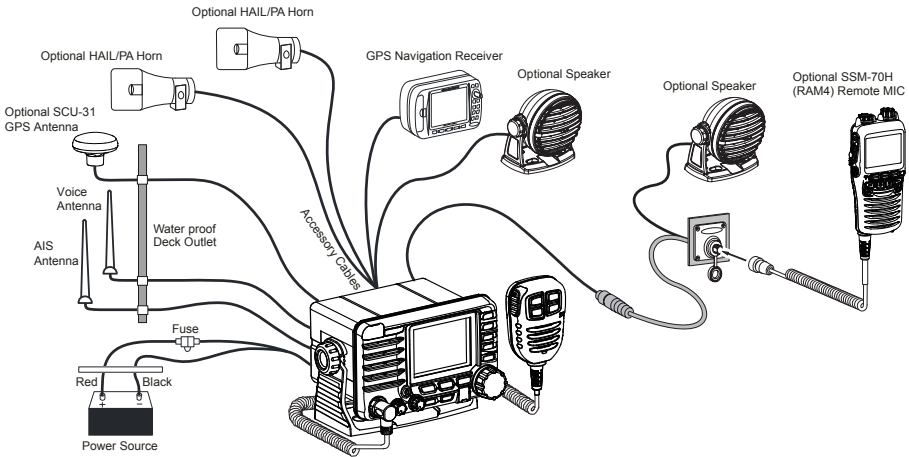

Ferrite Cores

To suppress RF interference that can cause abnormal operation of the transceiver, attach the supplied two ferrite cores as shown in the next page: bigger one to the accessory connection cable and the DC input cable together, and smaller one to the PA speaker connection cable and the external speaker connection cable together. Then snap the two halves of each ferrite core together. Attach each ferrite core as close as possible to the transceiver body. Finally, wind some plastic tape around each ferrite core, to prevent vibration from causing the two halves to split apart.

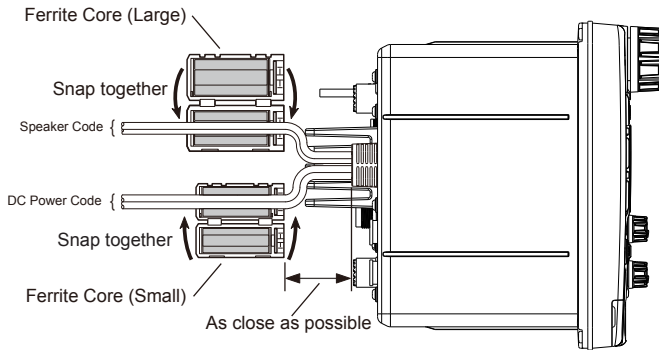

Fuse Replacement

To take out the fuse from the fuse holder, hold both ends of the fuse holder and pull the fuse holder apart without bending the fuse holder. When you replace the fuse, please confirm that the fuse is tightly fixed on the metal contact located inside the fuse holder. If the metal contact holding the fuse is loose, the fuse holder may heat up.

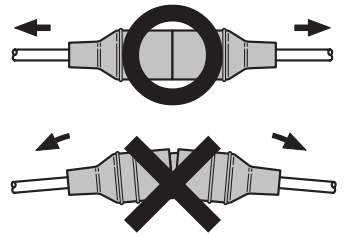

7.5 CONNECTION OF EXTERNAL DEVICES TO THE RADIO

7.5.1 Connecting the SCU-31 External GPS Antenna to the Radio

Connect the **SCU-31** cable to the GPS ANT (six pin) connector (White) on the rear panel, then tighten the cable nut (see illustration at the right).

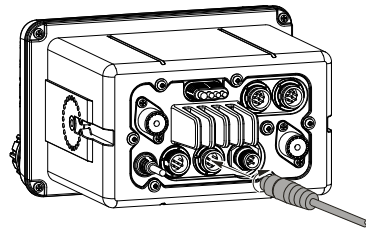

7.5.2 Connecting the NMEA 0183/NMEA 0183-HS to the Radio

External GPS Connections (NMEA 0183 4800 baud or NMEA 0183-HS 38400 baud)

The **GX6000** can select the NMEA baud rate between “4800 bps” and “38400 bps”. Refer to section “**18.9 NMEA 0183 IN/OUT**” for selection.

NMEA Input (GPS Information)

- **GX6000** can read NMEA 0183 version 2.0 or higher, and NMEA 0183-HS version 1.01 or higher.
- The NMEA 0183 input sentences are GLL, GGA, RMC, GNS, GSA, and GSV (RMC sentence is recommended).

- If 4800 baud (default) is selected:
The Blue and Green wires of input are at 4800 baud.
- If 38400 baud is selected:
The Blue and Green wires of input are at 38400 baud.

NMEA Output (DSC and GPS information)

- The NMEA 0183 output sentences are DSC and DSE.
- If 4800 baud (default) is selected:
 - a. The Gray and Brown wires output DSC and DSE sentences.
 - b. The Yellow and White wires of output AIS VDM sentence at 38400 baud.
- If 38400 baud is selected:
 - a. The Gray and Brown wires of output are at 38400 baud and includes both DSC (DSC, DSE) and AIS (VDM) sentences.
 - b. The Yellow and White wires always output AIS sentences at 38400 baud.
- GSA, GSV, GLL, GGA, and RMC sentences can be output in the **GX6000** by setting through the GPS setup menu (refer to section “**18.9 NMEA 0183 IN/OUT**”).

For further information on interfacing/setting up your GPS, please contact the manufacturer of the GPS receiver externally connected.

If you have further questions, please feel free to contact Product Support at:

Phone: (800) 767-2450

Email: marinetech@yaesu.com

7.5.3 Accessory Cables and NMEA 0183 Cables

The image and table below show the wires of the **GX6000** and the connections to optional devices such as an external GPS antenna, GPS chart plotter and an AIS receiver.

CAUTION

Care must be taken not to touch any of the NMEA wires to positive 12 VDC or the radio may be damaged.

When connecting the GPS navigation receiver, strip off about 1 inch (2.5 cm) of the specified wire’s insulation, then splice the ends together.

The **GX6000** uses NMEA 0183/-HS protocol to share coordinates, DSC and AIS information to and from a GPS chart plotter. The **GX6000** transfers AIS information to a GPS chart plotter at 38400 baud (sometimes called HS or High Speed). GPS and DSC information is transferred between a GPS chart plotter with multiple ports (minimum 2) at 4800 baud (default setting).

To connect to a GPS chart plotter which has one NMEA port, the **GX6000** may be setup to receive GPS coordinates, send DSC and AIS signals at 38400 baud. Refer to section “**18.9 NMEA 0183 IN/OUT**” for details.

7.5.4 NMEA 0813/NMEA 0183-HS to Chart Plotter

4800 Baud Connections

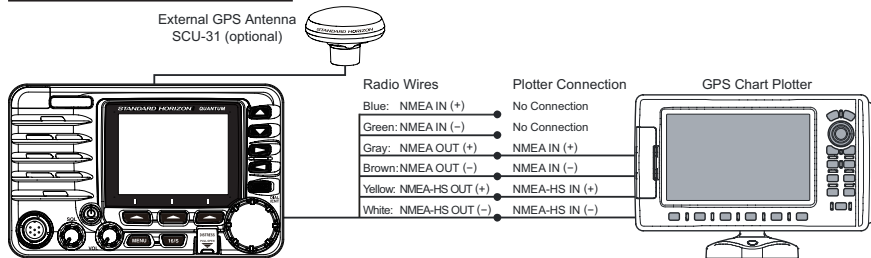

Wire Color/Description	Connection Examples
BLUE - NMEA GPS Input (+)	No connection
GREEN - NMEA GPS Input (-)	No connection
GRAY - NMEA DSC Output (+)	NMEA (+) input of GPS*1
BROWN - NMEA DSC Output (-)	NMEA (-) input of GPS*1
YELLOW - AIS Data Output (+)	NMEA-HS (+) input of AIS receiver*2
WHITE - AIS Data Output (-)	NMEA-HS (-) input of AIS receiver*2

*1: 4800 baud *2: 38400 baud

Note: Some GPS chart plotters have a single wire for NMEA signal ground. In such a case connect the NMEA input (-) to the GPS chart plotter's single NMEA signal ground wire, and leave the NMEA output (-) open. In case the assignment of power supply and ground of a GPS chart plotter to be used is different from that of the radio, connect the signal ground wire of the GPS chart plotter to the ground terminal (GND) on the rear panel of the radio.

38400 Baud Connections

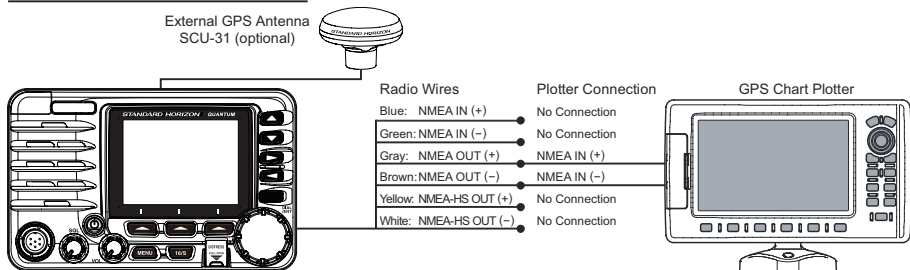

Wire Color/Description	Connection Examples
BLUE - NMEA GPS Input (+)	No connection
GREEN - NMEA GPS Input (-)	No connection
GRAY - NMEA DSC Output (+)	NMEA (+) input of GPS*1
BROWN - NMEA DSC Output (-)	NMEA (-) input of GPS*1
YELLOW - AIS Data Output (+)	No connection*2
WHITE - AIS Data Output (-)	No connection*2

*1: The GPS chart plotter Com Port must be setup to 38400 baud (HS) to receive DSC and AIS sentences from the **GX6000** (Gray and Brown wires).

*2: The **GX6000** always outputs NMEA 0183-HS VDM sentence at 38400.

Note: Some GPS chart plotters have a single wire for NMEA signal ground. In such a case connect the NMEA input (-) to the GPS chart plotter's single NMEA signal ground wire, and leave the NMEA output (-) open. In case the assignment of power supply and ground of a GPS chart plotter to be used is different from that of the radio, connect the signal ground wire of the GPS chart plotter to the ground terminal (GND) on the rear panel of the radio.

7.5.5 Connection to External GPS or Chart Plotter

4800 Baud Connections

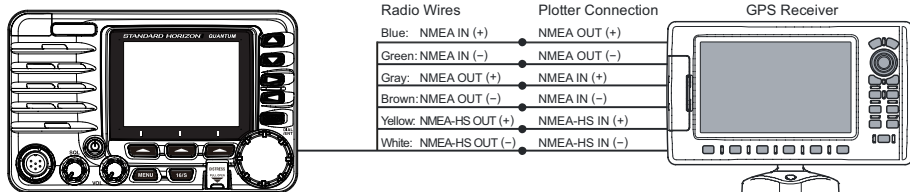

Wire Color/Description	Connection Examples
BLUE - NMEA GPS Input (+)	NMEA (+) output of GPS* ¹
GREEN - NMEA GPS Input (-)	NMEA (-) output or common ground of GPS* ¹
GRAY - NMEA DSC Output (+)	NMEA (+) input of GPS* ¹
BROWN - NMEA DSC Output (-)	NMEA (-) input of GPS* ¹
YELLOW - AIS Data Output (+)	NMEA-HS (+) input of AIS receiver* ²
WHITE - AIS Data Output (-)	NMEA-HS (-) input of AIS receiver* ²

*1: 4800 baud *2: 38400 baud

Note: Some GPS chart plotters have a single wire for NMEA signal ground. In such a case connect the NMEA input (-) to the GPS chart plotter's single NMEA signal ground wire, and leave the NMEA output (-) open. In case the assignment of power supply and ground of a GPS chart plotter to be used is different from that of the radio, connect the signal ground wire of the GPS chart plotter to the ground terminal (GND) on the rear panel of the radio.

38400 Baud Connections

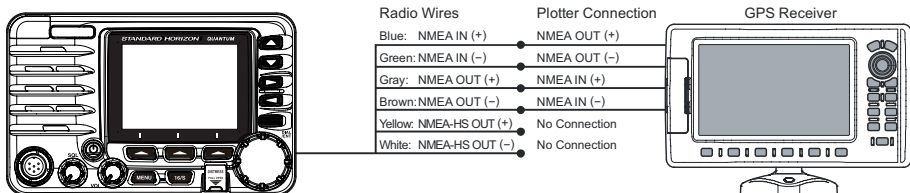

Wire Color/Description	Connection Examples
BLUE - NMEA GPS Input (+)	NMEA (+) output of GPS* ¹
GREEN - NMEA GPS Input (-)	NMEA (-) output or common ground of GPS* ¹
GRAY - NMEA DSC Output (+)	NMEA (+) input of GPS* ¹
BROWN - NMEA DSC Output (-)	NMEA (-) input of GPS* ¹
YELLOW - AIS Data Output (+)	No connection* ²
WHITE - AIS Data Output (-)	No connection* ²

*1: The GPS chart plotter ComPort must be setup to 38400 baud (HS) to send GPS coordinates to the **GX6000** (Blue and Green wires) and to receive DSC and AIS sentences from the **GX6000** (Gray and Brown wires).

*2: The **GX6000** always outputs NMEA 0183-HS VDM sentence at 38400.

Note: Some GPS chart plotters have a single wire for NMEA signal ground. In such a case connect the NMEA input (-) to the GPS chart plotter's single NMEA signal ground wire, and leave the NMEA output (-) open. In case the assignment of power supply and ground of a GPS chart plotter to be used is different from that of the radio, connect the signal ground wire of the GPS chart plotter to the ground terminal (GND) on the rear panel of the radio.

7.5.6 Connection to External PA/HAIL Speaker

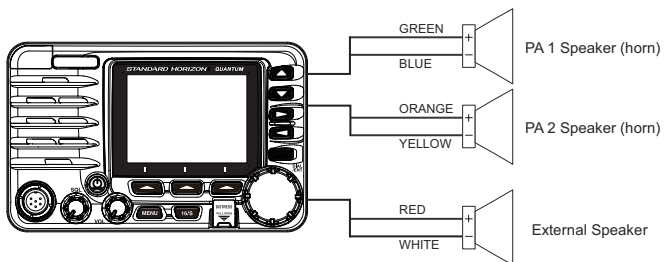

Wire Color/Description	Connection Examples
RED - External Speaker (+)	Positive wire of external 4 Ohm External speaker
WHITE - External Speaker (-)	Negative wire of external 4 Ohm External speaker
GREEN - PA1 Speaker (+)	Positive wire of external 4 Ohm audio speaker (horn)
BLUE - PA1 Speaker (-)	Negative wire of external 4 Ohm audio speaker (horn)
ORANGE - PA2 Speaker (+)	Positive wire of external 4 Ohm audio speaker (horn)
YELLOW - PA2 Speaker (-)	Negative wire of external 4 Ohm audio speaker (horn)

In some areas powerful AM broadcast stations may be heard when in listen-back mode. In this case change the speaker wire to 2-conductor shielded audio cable. See the illustration below for connections.

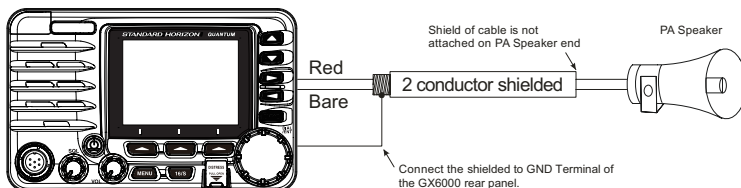

7.5.7 Rear Microphone Installation

The **GX6000** has an additional microphone connector on the rear panel that provides the same function as that on the front panel. Connect the optional MEK-4 (microphone extension kit) to the Rear MIC (six pin) connector on the rear panel, then tighten the cable nut (see illustration at the below).

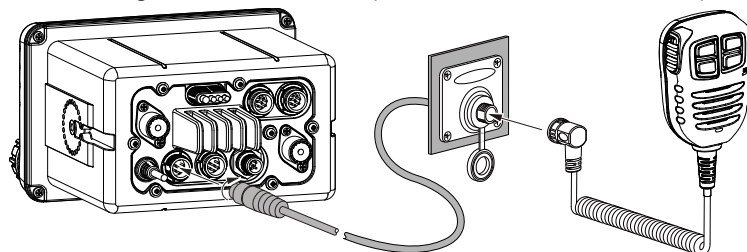

In addition, the GX6000 is capable of connecting hand microphone to the connector on either the front or rear panels.

7.5.8 Optional SSM-70H (RAM4) Installation

The **GX6000** is capable of using two **SSM-70H (RAM4)** Remote Station Microphones to remotely control the Radio, AIS, DSC and PA/Fog functions. In addition the **GX6000** can operate as a full function intercom system between the **SSM-70H (RAM4)** and the **GX6000**.

WARNING

Do not connect or remove the SSM-70H (RAM4) microphone while the radio is powered on. This may result in equipment failure.

1. Connect the Routing Cable (supplied with the **SSM-70H**) to the **RAM-1** or the **RAM-2** eight pin connector on the **GX6000** rear panel, then tighten the cable nut.

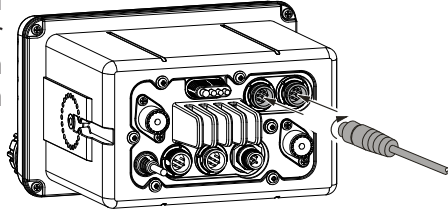

2. Install the two ferrite core (supplied with the **SSM-70H** Remote Station Microphone) to the routing cable or the **CT-100** extension cable, then snap its two halves together. These require to install near the connector by the each side of a transceiver and a microphone of the cable.
3. Attach the ferrite cores as close as possible to the plugs, as shown below.

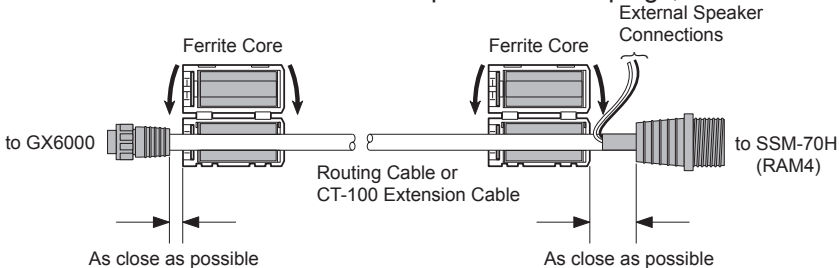

NOTE

Caution!: Before cutting the cable, it must be disconnected from the rear panel of the transceiver.

The routing cable can be cut and spliced, however care needs to be taken when reconnecting the wires to ensure water integrity.

After cutting you will notice there are the following wires:

Yellow, White, Brown, Gray, Blue, Green, Red/White*, Shield*

* The red/white and shield wires are wrapped in foil. Remove the foil, and separate the red/white and shield wires.

- Finally, wind some plastic tape around each ferrite core, to prevent vibration from causing the two halves to split apart.
- Referring to illustration right, make a 1.2" (30 mm) hole in the wall, then insert the extension cable into this hole. Connect the gasket and mount base to the extension cable connector using the nut.
- Drill the four screw holes (approx. 2 mm) on the wall, then install the mounting base to the wall using four screws.
- Put the rubber cap on to the nut. The installation is now complete.

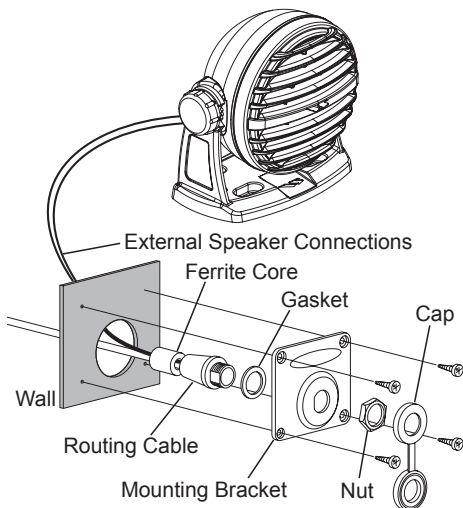

WARNING

It is not recommended to plug or unplug the **SSM-70H (RAM4)** Remote Station Microphone into the routing cable while the radio is powered on.

Connecting an External Speaker to the RAM4 Mic Cable

In noisy locations and **MLS-300** optional external speaker may be connected to the white speaker wires on the **RAM4** routing cable. The **RAM4** can drive the internal speaker or the external speaker one at a time. When connecting an external speaker, follow the procedure below to turn off the **RAM4** audio and enable the external speaker wires on the **RAM4** routing cable.

- On the **RAM4** mic, press the **MENU** key to display “**MENU**”.
- Rotate the **DIAL/ENT** knob to select “**SETUP**”, then press the [**SELECT**] soft key.
- Rotate the **DIAL/ENT** knob to select “**CONFIGURATION**”, then press the [**SELECT**] soft key.
- Rotate the **DIAL/ENT** knob to select “**SPEAKER SELECT**”, then press the [**SELECT**] soft key.

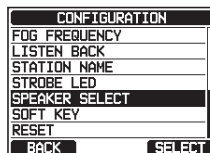
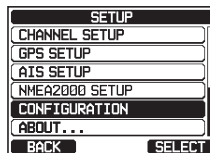

5. Rotate the **DIAL/ENT** knob to select “**INTERNAL**” or “**EXTERNAL**”, then press the [**SELECT**] soft key.
6. Press the **CLEAR/On** key to return to radio operation.

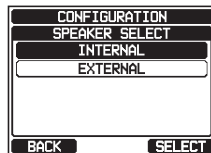

7.5.9 Optional SCU-30 Wireless Access Point Installation

The **GX6000** is capable of using a **SSM-71H (RAM4W)** Wireless Remote Station Microphone to remotely control the Radio, AIS, DSC and PA/Fog functions. In addition the **GX6000** can operate as a full function intercom system between the **RAM4W** and the **GX6000**.

The optional **SCU-30** Wireless Access Point, may be utilized to connect up to four **RAM4W** Wireless Remote Access Microphones to the **GX6000**.

WARNING

Do not connect or remove the SCU-30 Wireless Access Point while the radio is powered ON. This could result in damage to the equipment.

1. Connect the **SCU-30** Cable to the **RAM-1** Connector on the **GX6000** rear panel, and tighten the cable nut.

Note: For additional details on the connecting the **RAM4W** and **GX6000**, refer to the **RAM4W** Instruction Manual.

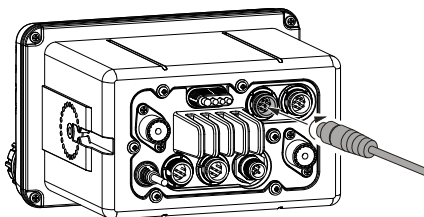

7.6 INITIAL SETUP REQUIRED WHEN TURNING ON THE POWER FOR THE FIRST TIME

7.6.1 Maritime Mobile Service Identity (MMSI)

What is an MMSI?

An MMSI is a nine digit number used on marine transceivers capable of using Digital Selective Calling (DSC) and Automatic Identification System (AIS) signal transmission. This number is used like a telephone number to selectively call other vessels.

THIS NUMBER MUST BE PROGRAMMED INTO THE RADIO TO OPERATE DSC FUNCTIONS.

How can I obtain an MMSI assignment?

In the USA, visit the following websites to register:

<http://www.boatus.com/mmsi/>

<https://www.seatow.com/tools-and-education/mmsi>

http://wireless.fcc.gov/services/index.htm?job=licensing&id=ship_stations

In Canada, visit

<http://www.ic.gc.ca/epic/site/smt-gst.nsf/en/sf01032e.html>

WARNING

The MMSI can be inputted only once, please be careful not to input the incorrect MMSI number. If you need to change the MMSI number after it has been entered, the radio will have to be returned to Factory Service. Refer to the section “**21.2 FACTORY SERVICE**”.

Programming the MMSI

1. Press the **MENU** key to display “**MENU**”.
2. Rotate the **DIAL/ENT** knob to select “**MMSI/POS INFO**”, then press the [**SELECT**] soft key. (To cancel, press the [**BACK**] soft key.)
To view your MMSI to ensure it is correct, perform steps 1 to 2.
3. Press the [**MMSI**] soft key.
The [**MMSI**] soft key is displayed which has not yet set the MMSI.
In the case of the GX6000 which has completed the MMSI setting, you can only check the MMSI on this screen.
4. Rotate the **DIAL/ENT** knob to select the first number of your MMSI, then press the [**SELECT**] soft key to step to the next number.
5. Repeat step 4 to set your MMSI number (9 digits).
6. If a mistake was made entering in the MMSI number, rotate the **DIAL/ENT** knob to select “←” or “→”, press the [**SELECT**] soft key until the wrong character is selected, then perform step 4.
7. When finished programming the MMSI number, press the [**FINISH**] soft key. The radio will ask you to input the MMSI number again. Perform steps 4 through 6 above.
8. After the second number has been input, press the [**FINISH**] soft key to store the MMSI.
9. Press the [**OK**] soft key to return to radio operation.

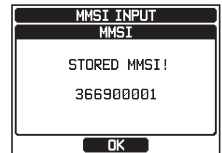
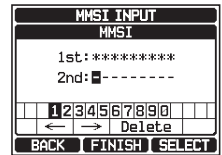
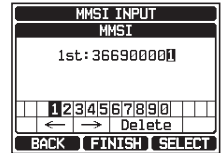
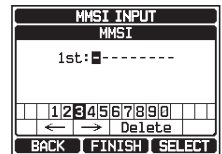
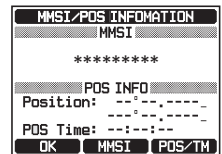
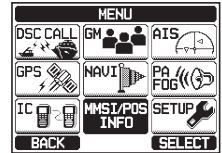

NOTE

To view your MMSI after programming to ensure it is correct, perform steps 1 to 2. Look that the MMSI number shown on the display is correct.

7.7 CHECKING GPS SIGNAL (GPS STATUS DISPLAY)

When the **GX6000** receives the GPS signal from the optional SCU-31, a small satellite icon “GPS” will appear on the display and your current location (latitude/longitude) is shown on the display. (*When the GPS signal receiving from the NMEA 2000 or NEMA-0183, a “2K” (NMEA 2000) icon or “I/O” (NMEA-0183) icon will appear on the display.)

NOTE

If there is a problem with the NMEA connection between the radio and the GPS, the GPS icon will blink continuously until the connection is corrected.

The **GX6000** has a GPS status display which shows the satellites currently being received, along with a graphical (bar-graph) representation of the relative signal strengths from the satellites.

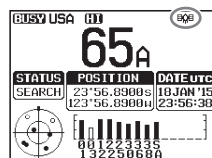

(GPS STATUS DISPLAY MODE)

NOTE

For the **GX6000** to properly show the GPS status page when an external GPS antenna or a chart plotter is connected it must be setup to output GSA and GSV NMEA 0183 sentences. When using the equipment of NMEA 2000, it must be able to output PGN No.129540 (GNSS Sats in View).

1. Press the **MENU** key to display “**MENU**”.
2. Rotate the **DIAL/ENT** knob to select “**GPS**”, then press the [**SELECT**] soft key.
3. Rotate the **DIAL/ENT** knob to select “**GPS STATUS**”, then press the [**ENTER**] soft key to display the GPS status currently being received.
4. Press the **CLEAR** key to return to radio operation.

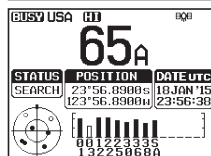
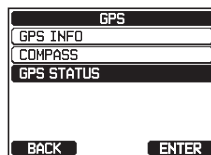

7.8 GPS CONFIGURATION

7.8.1 Changing the GPS Time

The **GX6000** shows GPS satellite time or UTC (Universal Time Coordinated) time in factory default. A time offset is needed to show the local time in your area. The time offset must be changed in order for the radio to display the current time in your area.

1. Press the **MENU** key to display “**MENU**”.
2. Rotate the **DIAL/ENT** knob to select “**SETUP**”, then press the **[SELECT]** soft key.
3. Rotate the **DIAL/ENT** knob to select “**GPS SETUP**”, then press the **[SELECT]** soft key.
4. Rotate the **DIAL/ENT** knob to select “**TIME OFFSET**”, then press the **[SELECT]** soft key.
5. Rotate the **DIAL/ENT** knob to select time offset of your location. See illustration above to find your offset time. If “00:00” is assigned, the time is the same as UTC or GPS satellite time.
6. Press the **[ENTER]** soft key to store the time offset.
7. Press the **CLEAR** key to return to radio operation.

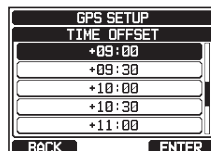
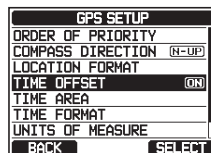
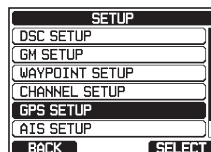

7.8.2 Changing the Time Area

This menu selection allows the radio to show UTC time or local time with offset.

1. Press the **MENU** key to display “**MENU**”.
2. Rotate the **DIAL/ENT** knob to select “**SETUP**”, then press the **[SELECT]** soft key.
3. Rotate the **DIAL/ENT** knob to select “**GPS SETUP**”, then press the **[SELECT]** soft key.

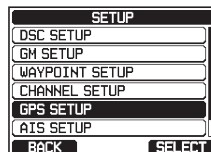

4. Rotate the **DIAL/ENT** knob to select “**TIME AREA**”, then press the **[SELECT]** soft key.

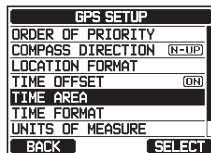

5. Rotate the **DIAL/ENT** knob to select “**UTC**” or “**LOCAL**”.
6. Press the **[ENTER]** soft key to store the selected setting.
7. Press the **CLEAR** key to return to radio operation.

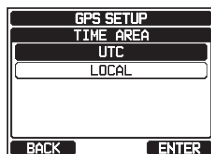

7.8.3 Changing the Time Format

This menu selection allows the radio to setup to show time in 12-hour or 24-hour format.

1. Press the **MENU** key to display “**MENU**”.
2. Rotate the **DIAL/ENT** knob to select “**SETUP**”, then press the **[SELECT]** soft key.



3. Rotate the **DIAL/ENT** knob to select “**GPS SETUP**”, then press the **[SELECT]** soft key.

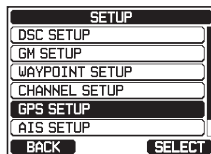

4. Rotate the **DIAL/ENT** knob to select “**TIME FORMAT**”, then press the **[SELECT]** soft key.

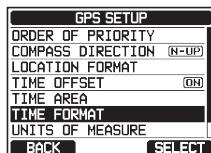

5. Rotate the **DIAL/ENT** knob to select “**24hour**” or “**12hour**”.
6. Press the **[ENTER]** soft key to store the selected setting.
7. Press the **CLEAR** key to return to radio operation.

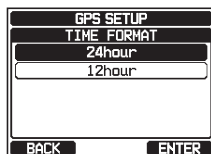

7.8.4 Changing COG to True or Magnetic

Allows the GPS COG (Course Over Ground) and the BRG from an AIS target to be selected to show in ON or OFF. Factory default is “OFF” however by following the steps below the COG can be changed to “ON”.

1. Press the **MENU** key to display “**MENU**”.
2. Rotate the **DIAL/ENT** knob to select “**SETUP**”, then press the [**SELECT**] soft key.
3. Rotate the **DIAL/ENT** knob to select “**GPS SETUP**”, then press the [**SELECT**] soft key.
4. Rotate the **DIAL/ENT** knob to select “**MAGNETIC VARIATION**”, then press the [**SELECT**] soft key.
5. Rotate the **DIAL/ENT** knob to select “**OFF**” or “**ON**”.
6. Press the [**ENTER**] soft key to store the selected setting.
7. Press the **CLEAR** key to return to radio operation.

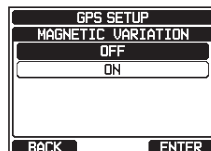
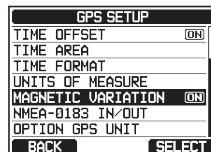
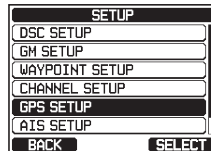



NOTE

Setting to “ON” is effective only when the RMC sentences with magnetic data are input from external devices such as a GPS receiver (The SCU-31 inputs the RMC sentences, but does not input with magnetic data.).

8 BASIC OPERATION

8.1 TURNING ON AND OFF THE TRANSCEIVER

1. After the transceiver has been installed, ensure that the power supply and antenna are properly connected.
2. Press and hold the  key to turn the radio on.
3. Press and hold the  key again to turn the radio off.

8.2 RECEPTION

1. Rotate the **SQL** knob fully counterclockwise. This state is known as “squelch off”.
2. Turn up the **VOL** knob until noise or audio from the speaker is at a comfortable level.
3. Rotate the **SQL** knob, clockwise until the random noise disappears. This state is known as the “squelch threshold”.
4. Rotate the **DIAL/ENT** knob or press the  key to select the desired channel. Refer to the channel chart on Pages 141, 141 and 142 to or available channels.
5. When a message is received, adjust the volume to the desired listening level. The “[**BUSY**]” indicator on the display indicates that communications are being received.

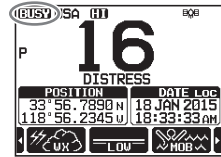

8.3 TRANSMISSION

1. Perform steps 1 through 4 of RECEPTION.
2. Before transmitting, monitor the channel to ensure it is clear.

THIS IS AN FCC REQUIREMENT!

3. Press the microphone's **PTT** (push-to-talk) switch. The “[**TX**]” indicator on the LCD is displayed.
4. Speak slowly and clearly into the microphone.
5. When the transmission is finished, release the microphone's **PTT** switch.

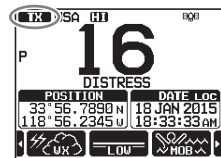

NOTE

Position your mouth about 1/2” (1.5 cm) away from the microphone hole and speak in a normal voice.

8.3.1 Transmit Power

The TX output power of the **GX6000** is set to high level (25W) in factory default, and the “[HI]” indicator is displayed on the top part of the screen.

To switch the TX output power:

1. Press the ►/◀ key repeatedly until the [HI] or [LOW] soft key is displayed at the bottom of the screen.
2. Press the [HI] or [LOW] soft key to switch between HI (25W) or LO (1W) output power.
When the TX output power is set to “Low” while the transceiver is on channel 13 or 67, the output power will temporarily switch from “Low” to “High” power until the **PTT** switch of the microphone is released. This soft key is not function on transmit inhibited and low power only channels.

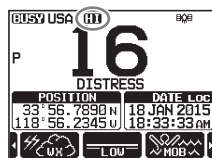

8.4 BASIC OPERATION OF THE MENU MODE

Using the menu mode, the various functions of the **GX6000** can be customized to match the method of use. You can select the items that you would like to adjust from the respective lists and enter or select the appropriate settings for the intended various operation.

1. Press the **MENU** key on the operation mode screen to display “MENU”.
2. Rotate the **DIAL/ENT** knob or press the ▲/▼/►/◀ key to select the menu item, then press the [SELECT] soft key or press the **DIAL/ENT** knob to display “MENU LIST”.
3. Rotate the **DIAL/ENT** knob or press the ▲/▼ key to select the item, then press the [SELECT] soft key or press the **DIAL/ENT** knob.
4. Rotate the **DIAL/ENT** knob or press the ▲/▼ key to select the item, then press the [SELECT] soft key or press the **DIAL/ENT** knob.

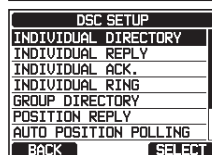
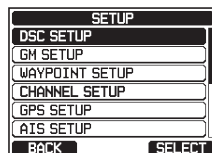

5. Rotate the **DIAL/ENT** knob or press the ▲/▼ key to select the desired setting.

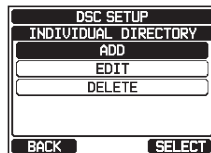

6. Press the **[ENTER]** soft key or press the **DIAL/ENT** knob store the selected setting.
7. Press the **CLEAR** key to return to radio operation.
(The display can also be returned to the previous screen by pressing the **[BACK]** soft key.)

The same operation process as the above is written as follows in this operation manual.



8.5 TRANSMIT TIME-OUT TIMER (TOT)

When the **PTT** switch on the microphone is held down, transmit time is limited to 5 minutes. This limits unintentional transmissions due to a stuck microphone. About 10 seconds before automatic transmitter shutdown, a warning beep will be heard from the speaker(s). The transceiver will automatically go to receive mode, even if the **PTT** switch is continually held down. Before transmitting again, the **PTT** switch must first be released and then pressed again.

NOTE

Once the transmitter is shut down by the TOT, transmission to the last channel is only allowed 10 seconds after the shutdown.

8.6 SIMPLEX/DUPLEX CHANNEL USE

Refer to the **VHF MARINE CHANNEL CHART** (Pages 141 , 141 and 142) for instructions on use of simplex and duplex channels.

NOTE

All channels are factory-programmed in accordance with FCC (USA), Industry Canada (Canada), and International regulations. Mode of operation cannot be altered from simplex to duplex or vice-versa.

8.7 USA, INTERNATIONAL, AND CANADA MODE

To change the channel group from USA to International or Canada:

1. Press the **MENU** key to display “MENU”.
2. Rotate the **DIAL/ENT** knob to select “**SETUP**”, then press the **[SELECT]** soft key.
3. Rotate the **DIAL/ENT** knob to select “**CHANNEL SETUP**”, then press the **[SELECT]** soft key.
4. Rotate the **DIAL/ENT** knob to select “**CHANNEL GROUP**”, then press the **[SELECT]** soft key.
5. Rotate the **DIAL/ENT** knob to select desired channel group “**USA**”, “**INTL**”, or “**CAN**”.
6. Press the **[ENTER]** soft key to store the selected setting.
7. Press the **CLEAR** key to return to radio operation.

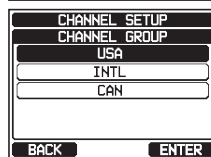
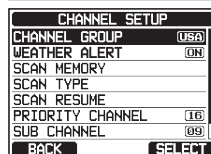
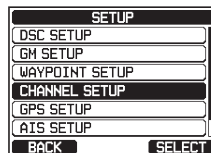

8.8 NOAA WEATHER CHANNELS

1. To receive a NOAA weather channel, press the **▶/◀** key repeatedly until the **[WX]** soft key is displayed at the bottom of the screen.
2. Press the **[WX]** soft key. The “**WX**” indicator appears on the top part of the screen.
3. Rotate the **DIAL/ENT** knob to select a different NOAA weather channel.
4. To exit from the NOAA weather channels, press the **[CH]** soft key. The transceiver returns to the channel it was on prior to a weather channel and the “**WX**” indicator disappears from the display.

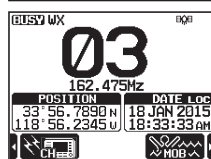
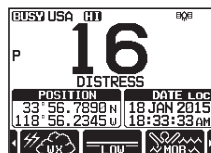

8.8.1 NOAA Weather Alert

In the event of extreme weather disturbances, such as storms and hurricanes, the NOAA (National Oceanic and Atmospheric Administration) sends a weather alert accompanied by a 1050 Hz tone and subsequent weather report on one of the NOAA weather channels.

The **GX6000** can receive weather alerts when monitoring a weather channel and, on the last selected weather channel during scanning modes or while on another working channel.

When an alert is received on a NOAA weather channel, scanning will stop and the transceiver will emit a loud beep to alert the user of a NOAA broadcast. Press any key to stop the alert. After stopping the beep sound, the weather alert reception confirmation screen will appear. Press **[OK]** to display a confirmation screen. The confirmation screen will ask you whether to move to the weather channel or return in the marine channel. Press **[YES]** to switch to the weather channel, and press **[NO]** to return to the marine channel.

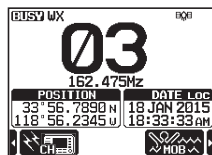

To disable the weather alert function, refer to section “**16.2 WEATHER ALERT**”.

NOTE

If no key is pressed the alert will sound for 5 minutes and then the weather report will be received.

8.8.2 NOAA Weather Alert Testing

NOAA tests the alert system every Wednesday between 11AM and 1PM. To test the **GX6000**'s NOAA weather feature, setup as in section “**8.8.1 NOAA Weather Alert**” and confirm the alert is heard on Wednesdays between 11AM and 1PM local time.

8.9 MULTI WATCH (TO PRIORITY CHANNEL)

Multi watch is used to scan two or three channels for communications.

- In Dual Watch, a normal VHF channel and the priority channel are scanned alternately.
- In Triple Watch, a normal VHF channel, the priority channel, and the sub channel are scanned alternately.

When a signal is received on the normal channel the radio briefly switches between the normal channel and the priority channel to look for a transmission. If the radio receives communications on the priority channel the radio stops and listens to priority channel until communication ends and then starts dual or triple watch scan again.

8.9.1 Setting up the Multi Watch Operation

1.  → "SETUP" → "CHANNEL SETUP" → "MULTI WATCH"

2. Rotate the **DIAL/ENT** knob to select "**DUAL**" or "**TRIPLE**".
3. Press the **[ENTER]** soft key to store the selected setting.
4. Press the **[CLEAR]** key to return to radio operation.

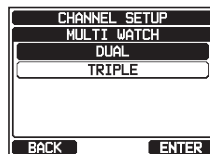

8.9.2 Starting the Dual Watch

1. Adjust the **SQL** knob until the background noise disappears.
2. Rotate the **DIAL/ENT** knob to select a channel you wish to watch.
3. Press **▶/◀** key repeatedly until the **[DUAL WATCH]** soft key is displayed at the bottom of the screen, press the **[DUAL WATCH]** soft key.

The radio will monitor the priority channel and the channel that was selected in step 2.

If a signal is received on the channel selected in step 2, the **GX6000** will dual watch to priority channel.

4. To stop dual watch, press the **[DUAL WATCH]** soft key again.

When selecting "**TRIPLE**" in the SETUP menu, **[TRIPLE WATCH]** will be displayed as the soft key instead of **[DUAL WATCH]**.

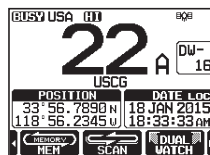

NOTE

The priority channel may be changed from CH16 (default) to another channel. Refer to section "**16.7 PRIORITY CHANNEL**".

8.10 SCANNING

The **GX6000** will automatically scan channels programmed into the preset channel memory and also the scan channel memory, and the last selected weather channel.

When an incoming signal is detected on one of the channels during scan, the radio will pause on that channel, allowing you to listen to the incoming transmission. The radio will automatically start scanning again after the transmission stops.

8.10.1 Selecting the Scan Type

1. **[MENU]** \Rightarrow **"SETUP"** \Rightarrow **"CHANNEL SETUP"** \Rightarrow **"SCAN TYPE"**

2. Rotate the **DIAL/ENT** knob to select **"PRIORITY"** or **"MEMORY"**.
3. Press the **[ENTER]** soft key to store the selected setting.
4. Press the **[CLEAR]** key to return to radio operation.

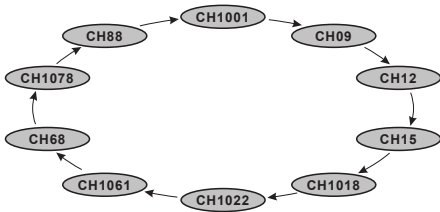
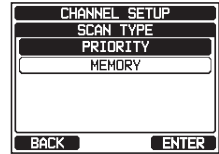

Memory Scan (M-SCAN)

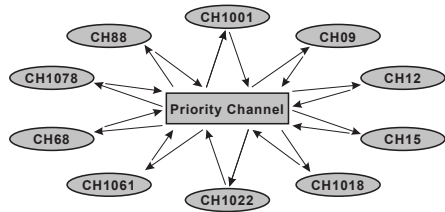

Priority Scan (P-SCAN)

8.10.2 Programming Scan Memory

1. **[MENU]** \Rightarrow **"SETUP"** \Rightarrow **"CHANNEL SETUP"** \Rightarrow **"SCAN MEMORY"**

2. Rotate the **DIAL/ENT** knob to select a desired channel to be scanned, then press the **[MEM]** soft keys. **"ON"** icon will appear at the right side of the selected channel.

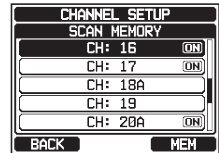

3. Repeat step 2 for all the desired channels to be scanned.
4. To REMOVE a channel from the list, select the channel then press the **[MEM]** soft key. **"ON"** icon of the selected channel will disappear.
5. When you have completed your selection, press the **CLEAR** key to return to radio operation.

To check channels to be scanned, rotate the **DIAL/ENT** knob. The “[MEM]” icon will appear when the memory channel is displayed.

Note: When “SCAN MEMORY” is assigned to the soft key, the memory function switches between on and off every time you press the [MEM] soft key.

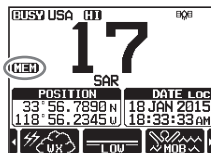

8.10.3 Memory Scanning (M-SCAN)

1. Set the scan type to “MEMORY” in the SETUP menu (refer to “8.10.1 Selecting the Scan Type”).
2. Adjust the **SQL** knob until the background noise disappears.
3. Press the ►/◀ key repeatedly, then press the [SCAN] soft key. “MEM SCAN” appears on the display. Scanning will proceed from the lowest to the highest programmed channel number and preset channel (described in the next section) and will stop on a channel when a transmission is received. The channel number will blink during reception.
4. To stop scanning, press the [SCAN] soft key, **16/S** or **CLEAR** key.

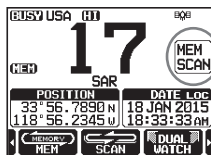

8.10.4 Priority Scanning (P-SCAN)

1. Set the scan type to “PRIORITY” in the SETUP menu (refer to “8.10.1 Selecting the Scan Type”).
2. Adjust the **SQL** knob until the background noise disappears.
3. Press the ►/◀ key repeatedly, then press the [SCAN] soft key. “PRI SCAN” appears on the display. Scanning will proceed between the memorized channels and the priority channel. The priority channel will be scanned after each programmed channel.
4. To stop scanning, press the [SCAN] soft key, **16/S** or **CLEAR** key.

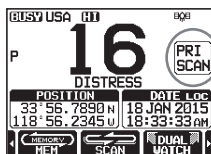

NOTE

In the default setting, Channel 16 is set as the priority channel. You may change the priority channel to the desired channel from Channel 16 on the SETUP menu. Refer to section “16.7 PRIORITY CHANNEL”.

8.11 PRESET CHANNELS: INSTANT ACCESS

10 preset channels can be programmed for instant access. Press the ►/◀ key repeatedly, then press the **[PRESET]** soft key. Pressing the **[PRESET]** key activates the user assigned channel bank. If the **[PRESET]** soft key is pressed and no channels have been assigned, alert beep will sound.

Before beginning the Instant Access operation, assign the “PRESET” command into one of the programmable keys, refer to section “**15.8 SOFT KEYS**”.

8.11.1 Programming

1. Rotate the **DIAL/ENT** knob to select the channel to be programmed.
2. Press the ►/◀ key repeatedly to indicate the function on the display, then press and hold the **[PRESET]** soft key until the “**P-SET**” icon and channel number are blinking.
3. Press the **[ADD]** soft key to program the channel into the preset channel memory. “**[P-SET]**” icon will appear.
4. Repeat steps 1 through 3 to program the desired channels into the preset channels. Up to 10 channels can be registered. If you attempt to register the 11th channel, error beep will sound.

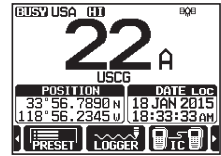

8.11.2 Operation

1. Press the ►/◀ key repeatedly, then press the **[PRESET]** soft key to recall the preset channel. The “**[P-SET]**” icon will appear on the display.
2. Rotate the **DIAL/ENT** knob to select the desired preset channel.
3. Press the **[PRESET]** soft key to return to the last selected channel. The “**[P-SET]**” icon will disappear from the display.

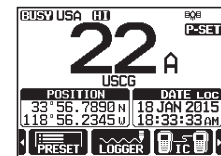
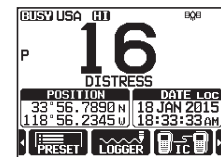

8.11.3 Deletion

1. Press the ►/◄ key repeatedly, then press the **[PRESET]** soft key to recall the preset channel.
2. Rotate the **DIAL/ENT** knob to select the preset channel to be deleted.
3. Press and hold the **[PRESET]** soft key until the “**[P-SET]**” icon and channel number are blinking.
4. Press the **[DELETE]** soft key to delete the channel from the preset channel memory.
5. Repeat steps 2 through 4 to delete the desired channels from preset channels.
6. To exit from deleting the preset channels, press the **[QUIT]** soft key.

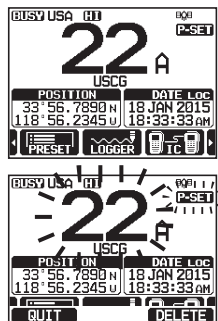

8.12 MOB OPERATION

The **GX6000** provides a feature to memorize the position information instantly in case of MOB (Man Over-Board).

1. Press the ►/◄ key repeatedly, then press the **[MOB]** soft key.
2. Press the **[TO WPT]** soft key to start the navigation to the displayed position. For details about the navigation, see section “**11 NAVIGATION**”.
To modify the displayed position information, press the **[POS/TM]** soft key. For details about the modification, see “**Editing a Waypoint**” on page 86.
3. To transmit a DSC distress message, lift the red spring loaded DISTRESS cover on the right side of the transceiver, then press and hold the **DISTRESS** key (see section “**10.2.1 Transmitting a DSC Distress Alert**” for details).

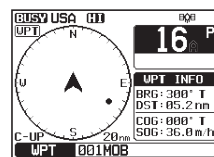
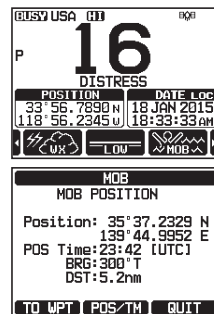

The nature of the distress call is automatically set to “**MOB**”.

8.13 PA/FOG OPERATION

The **GX6000** has two 25 W hailers built-in and can be used with any 4 Ohm PA horn. Standard Horizon offers two HAIL/PA horns, the **220SW** (5" round 30 Watt HAIL/PA horn) and the **240SW** (5" x 8" rectangular 40 Watt HAIL/PA horn). When the **GX6000** is in PA Hail mode the PA speaker listens back (acts as a microphone and provides two-way communications through the HAIL/PA horn to the main radio).

NOTE

When in the PA HAIL or FOG HORN mode, the **GX6000** will continue to receive DSC calls and communications on the last selected working channel prior to entering the PA HAIL or FOG HORN mode. Then the **GX6000** AIS page can also be accessed when in the PA HAIL or FOG HORN mode.

PA HAIL mode:

PA HAIL mode allows the transceiver to be used as a power hailer when an optional STANDARD HORIZON **220SW** or **240SW** HAIL/PA horn is installed. The PA Hail mode has a listen-back feature which provides two way communication through the HAIL/PA horn.

FOG HORN mode:

Automatic signaling is transmitted through the HAIL/PA horn. When the fog horn signal is not being outputted the **GX6000** listens back through the connected HAIL/PA horn.

HORN mode:

Foghorn sound or siren sound can be transmitted through the HAIL/PA horn. When the fog horn signal is not being outputted the **GX6000** listens back through the connected HAIL/PA horn.

8.13.1 Operating the PA HAIL mode

1.  → "PA FOG" → "PUBLIC ADDRESS"

2. Rotate the **DIAL/ENT** knob to speaker select "ALL", "PA1" or "PA2", then press the **[SELECT]** soft key. Press the microphone's **PTT** switch to speak through the HAIL/PA speaker.

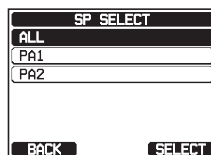

3. Press the **[PA VOL]** soft key, then rotate the **DIAL/ENT** knob to control the AF output level. Press the **[ENTER]** soft key. The AF output level can be set from 0 to 31.

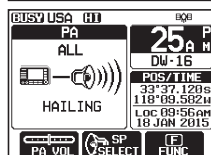

- To listen back, rotate the **VOL** knob.
- Press the **CLEAR** key to return to radio operation.

8.13.2 Operating the FOG HORN mode

The user can select the type of horn from “Underway”, “Stop”, “Sail”, “Towing”, “Aground” and “Anchor”.

1.  → “PA FOG” → “FOG HORN”

2. Rotate the **DIAL/ENT** knob to select one of the six functions described above, then press the **[SELECT]** soft key.

3. Rotate the **DIAL/ENT** knob to speaker select “ALL”, “PA1” or “PA2”, then press the **[SELECT]** soft key.

4. On the “**FOG HORN**” mode, while pressing the **[HORN]** soft key to activate the tone through the HAIL/PA speaker.

Press the **[FOG VOL]** soft key, then rotate the **DIAL/ENT** knob to control the AF output level.

Press the **[ENTER]** soft key. The AF output level can be set from 0 to 31.

- To listen back, rotate the **VOL** knob.
- Press the **CLEAR** key to return to radio operation.

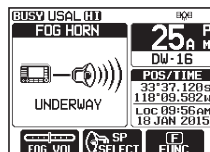
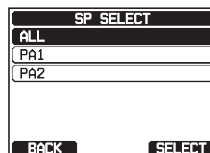
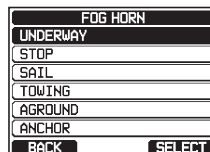

8.13.3 Fog Signal Timing Chart

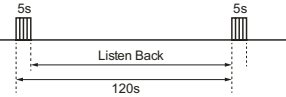
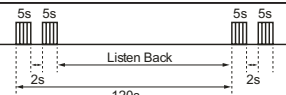
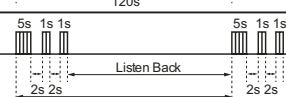
TYPE	PATTERN	USAGE
UNDERWAY	One 5-second blasts every 120 seconds. 	Motor vessel underway and making way.
STOP	Two 5-second blasts (separated by 2 seconds) every 120 seconds. 	Motor vessel underway but stopped (not making way).
SAIL	One 5-second blasts followed by two 1-second blasts (separated by 2 seconds) every 120 seconds. 	Sailing vessel underway, fishing vessel (underway or anchored), vessel not under command, a vessel restricted in her ability to maneuver (underway or at anchor), or a vessel towing or pushing another ahead.

TYPE	PATTERN	USAGE
TOWING	<p>One 5-second blasts followed by three 1-second blasts (separated by 2 seconds) every 120 seconds.</p>	Vessel under tow (manned).
AGROUND	<p>One 11-second rings every 60 seconds.</p>	Vessel is aground.
ANCHOR	<p>One 5-second rings every 60 seconds.</p>	Vessel is at anchor.

8.13.4 Operating the HORN mode

The user can select the type of horn from “Horn” and “Siren”.

1. **[MENU]** → “PA FOG” → “HORN”

2. Rotate the **DIAL/ENT** knob to select “**HORN**” or “**SIREN**”, then press the **[SELECT]** soft key.

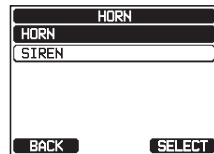

3. Rotate the **DIAL/ENT** knob to speaker select “**ALL**”, “**PA1**” or “**PA2**”, then press the **[SELECT]** soft key.

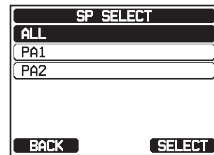

4. On the “**Horn**” and “**Siren**” modes, while pressing the **[HORN]** soft key to activate the tone through the HAIL/PA speaker.

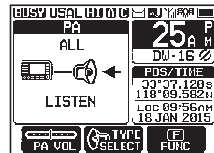

Press the **[FOG VOL]** soft key, then rotate the **DIAL/ENT** knob to control the AF output level. Press the **[ENTER]** soft key. The AF output level can be set from 0 to 31.

5. To listen back, rotate the **VOL** knob.

6. Press the **CLEAR** key to return to radio operation.

8.14 INTERCOM OPERATION

The optional **SSM-70H (RAM4)** remote station microphone must be connected to perform intercom functions between the **GX6000** and the **SSM-70H (RAM4)**.

NOTE

When using the intercom function, connect one or two **SSM-70H (RAM4)** Remote Station Microphone to the **GX6000**.

8.14.1 Communication

1.  → "IC"

2. Rotate the **DIAL/ENT** knob to select the device to which you want to communicate, then press the **[SELECT]** soft key. The "✓" icon will appear at the left side of the selected station.

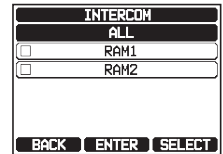

Note: When only one **SSM-70H (RAM4)** is connected to GX6000, continue to step 5.

3. Repeat step 2 for all the desired devices.
4. Press the **[ENTER]** soft key.
5. When the intercom mode is enabled, "INTERCOM" is displayed on the radio and **SSM-70H (RAM4)**.
6. Press the microphone's **PTT** switch on the radio. "Talk" will be shown on the display.

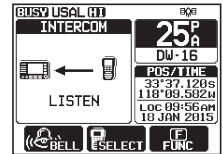

Note: A warning beep will be heard when the radio's **PTT** and **RAM4**'s **PTT** switches are pushed at the same time.

7. Speak slowly and clearly into the microphone, hold the microphone about 1/2" (1.5 cm) away from your mouth.
8. When finished, release the **PTT** switch.
9. Press the **CLEAR** key to return to radio operation.

8.14.2 Calling

Pressing the **[BELL]** soft key when in intercom mode on either the radio or **RAM4** microphone will produce a calling beep to the other station.

8.15 VOICE SCRAMBLER

The voice scrambler function for the 4-code type (**CVS2500A** compatible) or the 32-code type (**FVP-42** compatible for Furuno Electric FM-4721) is available by configuring optional settings. Refer to the section "16.13 SCRAMBLER SETUP" to program the voice scrambler.

1. Select a channel that was programmed for scrambler mode (the “

8.16 DEMO MODE

This mode is used by Standard Horizon sales persons and dealers to demonstrate radio, DSC and AIS functions. Demo mode allows latitude, longitude and time to be entered to simulate radio displays. When the demo mode is enabled, the radio display will automatically switch from the NORMAL, COMPASS, WAYPOINT, AIS and GM displays.

NOTE

When demo mode is enabled and the radio is turned off and back on the radio will still be in the demo mode.

1.  → “**SETUP**” → “**ABOUT...**” → “**DEMO OPERATION**” → “**DEMO POSITION INPUT**”

2. Enter the latitude/longitude of your vessel and your local UTC time in the 24-hour notation by the **DIAL/ENT** knob. Rotate the **DIAL/ENT** knob to select the number and press the **[SELECT]** soft key to move the cursor to the next character.

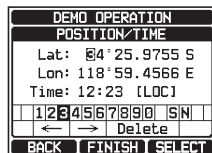

3. If a mistake was made entering in the latitude/longitude of your vessel and your local UTC time, rotate the **DIAL/ENT** knob to select “←” or “→”, press the **[SELECT]** soft key until the wrong character is selected, then perform step 2.
4. To store the data entered, press the **[FINISH]** soft key.
5. Rotate the **DIAL/ENT** knob to select “**DEMO START**”, then press the **[SELECT]** soft key.

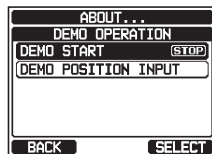

6. Rotate the **DIAL/ENT** knob to select “**START**”, then press the **[SELECT]** soft key.

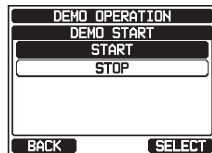

NOTE

To stop the demo mode, select “STOP” in step 6 above.

9 GPS OPERATION

The **GX6000** has the optional **SCU-31** external GPS antenna to receive and display the position information. When the radio is connected to an external GPS device by the NMEA-0183 or NMEA2000, you may select the order of priority of the connection devices to be used when obtaining location information via the SETUP menu (Refer to section “**18.1 ORDER OF PRIORITY**”). Your position information as well as received positions can be memorized and utilized later for navigation.

9.1 DISPLAYING POSITION INFORMATION

9.1.1 GPS Information Numerical Display

1.  → “GPS” → “GPS INFO”

2. Display the numerical display.
3. Press the **CLEAR** key to return to radio operation.

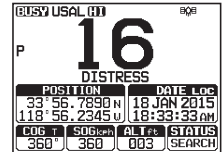

9.1.2 GPS Information Compass Display

1.  → “GPS” → “COMPASS”

2. Display the compass display.
3. Press the **CLEAR** key to return to radio operation.

Note: Depending on the assignment of the soft keys you may switch the screen immediately from the basic display to the compass display by pressing the **[COMP]** soft key.

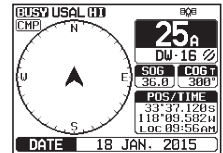

9.2 CHECKING GPS STATUS

1.  → “GPS” → “GPS STATUS”

2. Display the GPS status currently being received.
3. Press the **CLEAR** key to return to radio operation.

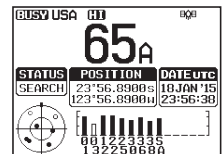

9.3 GPS LOGGER OPERATION

The **GX6000*** includes a logger for position information that allows you to record your location at regular intervals. (* Requires optional **SCU-31** GPS Receiver.)

1. Press the **[LOGGER]** soft key to turn the function on or off.

The recording starts and the display returns to the previous screen with the “” icon on the top of the display.

- You may change the log interval time of recording via the SETUP menu (Refer to section “**18.11.4 Logger Interval**”).

Note: To utilize the records, connect the **GX6000** to a PC and download the log data from the radio by using the PC Programming Software. Refer to section “**20 CONNECTING A USB DATA TERMINAL TO THE PC**”.

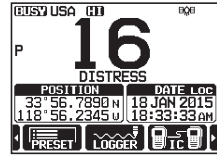

Logger operation alert:

- When the memory for log data becomes full, three beeps will sound and a warning message will be displayed. Afterwards the logger does not operate until the log data in the memory are erased.
- When the logger cannot record for some reason, three beeps will sound and a warning message will be displayed. Afterwards the logger does not operate anymore.
- An error message will be displayed when the radio cannot erase the log data in the memory during the operation following the alert of memory full (see above) or in the SETUP menu (Refer to section “**18.11.5 Log Erase**”).

10 DIGITAL SELECTIVE CALLING (DSC)

10.1 GENERAL

WARNING

This **GX6000** is designed to generate a digital maritime distress and safety call to facilitate search and rescue. To be effective as a safety device, this equipment must be used only within communication range of a shore-based VHF marine channel 70 distress and safety watch system. The range of signal may vary but under normal conditions should be approximately 20 nautical miles.

NOTE

A DSC Warning sticker is included with the **GX6000**. To comply with FCC regulations this sticker must be mounted in a location that can be easily viewed from the location of the **GX6000**.

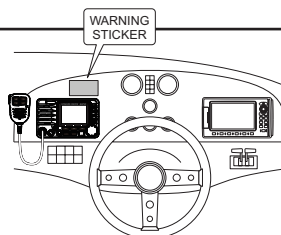

Digital Selective Calling (DSC) is a semi-automated method of establishing a radio call, it has been designated by the International Maritime Organization (IMO) as an international standard for establishing VHF, MF and HF radio calls. It has also been designated as part of the Global Maritime Distress and Safety System (GMDSS). It is planned that DSC will eventually replace aural watches on distress frequencies and will be used to announce routine and urgent maritime safety information broadcasts.

This system allows mariners to instantly send a distress call with GPS position (when connected to the transceiver) to the Coast Guard and other vessels within range of the transmission. DSC will also allow mariners to initiate or receive Distress, Urgency, Safety, Routine, Position Request, and Position Report, Automatic Position Polling, and Group calls to or from another vessel equipped with a DSC transceiver.

10.2 DSC DISTRESS ALERT

The **GX6000** is capable of transmitting and receiving DSC distress messages to all DSC radios. Distress alert calls from the **GX6000** include the latitude and longitude of the vessel when the external GPS unit is activated.

10.2.1 Transmitting a DSC Distress Alert

NOTE

To be able to transmit a DSC distress call, MMSI number must be programmed, refer to section “**7.6.1 Maritime Mobile Service Identity (MMSI)**”.

In order for your ship's location to be transmitted, the **GX6000** must be able to receive a valid position data from the SCU-31 external GPS antenna or other GPS device connected by NMEA 0183 or NEMA 2000. Refer to section “**7.5.3 Accessory Cables and NMEA 0183 Cables**”

Basic Operation

1. Lift the red spring loaded DISTRESS cover, press once and then press and hold the **DISTRESS** key for 3 seconds. The radio display will count down (3-2-1) and then transmit the distress call. The backlight of the display and keypad flashes while the radio's display is counting down.
2. When the distress signal is sent, the transceiver watches for a transmission on CH70 until an acknowledgment signal is received.
3. If no acknowledgment is received, the distress call is repeated in 4 minute intervals until a DSC acknowledgment is received.
4. When a DSC distress acknowledgment is received, a distress alarm sounds and Channel 16 is automatically selected. The display shows the MMSI of the ship responding to your distress.
5. Press the microphone's **PTT** switch and state your name, vessel name, number of persons on board and the distress situation, then say “**over**” and wait for a reply from the acknowledging ship.
6. To turn off the distress alarm before the radio retransmits the distress alert, press the **16/S** key or the **[QUIT]** soft key.

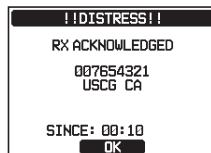
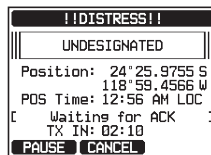
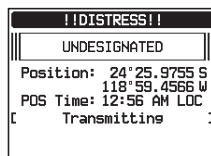
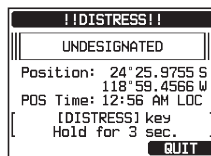

Transmitting a DSC Distress Alert with Nature of Distress

The **GX6000** is capable of transmitting a DSC distress alert with the following “Nature of Distress” categories:

Undesignated, Fire/Explosion, Flooding, Collision, Grounding, Capsizing, Sinking, Adrift, Abandoning, Piracy, MOB.

1.  → “DSC CALL” → “DIST ALERT MSG”

2. Press the **[NATURE]** soft key. The “NATURE OF” menu will appear on the display.

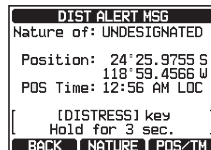

3. Rotate the **DIAL/ENT** knob to select the desired nature of distress category, then press the **[SELECT]** soft key.

4. Press and hold the **DISTRESS** key until a distress alert is transmitted.

Transmitting a DSC Distress Alert by Manually Inputting Location and Time

In case the **GX6000** fails to get a GPS position fix, you may manually input your latitude and longitude, and time before transmitting the distress alert.

1.  → “DSC CALL” → “DIST ALERT MSG”

2. Press the **[POS/TM]** soft key.

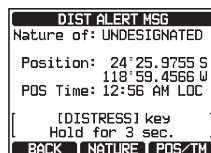

3. Rotate the **DIAL/ENT** knob to select the first number of latitude, then press the **[SELECT]** soft key to step to the next number.

4. Repeat step 3 to set the position and time.

If a mistake was made, rotate the **DIAL/ENT** knob to select “←” or “→”, press the **[SELECT]** soft key until the wrong character is selected, then perform step 3.

5. When finished programming the position and time, press the **[FINISH]** soft key. The display will return to the previous screen.

6. Press and hold the **DISTRESS** key until a distress alert is transmitted.



Pausing a DSC Distress Alert

After a DSC distress call is transmitted, the DSC distress call is repeated every 4 minutes until the call is canceled by the user or until the radio is turned off and on again. The **GX6000** has the capability to suspend (pause) the retransmitting of the distress call by the procedure below.

1. After the distress call is transmitted, the radio will show the display as on the right.

Looking at this display you will notice "TX IN: 02:10", this is the time when the radio will re-transmit the DSC distress call.

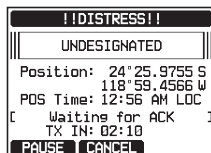

2. To suspend re-transmitting the DSC call, press the **[PAUSE]** soft key.
3. To resume counting down to transmit the DSC Distress call, press the **[RESUME]** soft key.

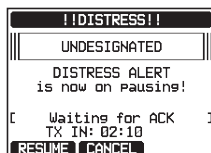

Canceling a DSC Distress Alert

If a DSC distress alert was sent by error the **GX6000** allows you to send a message to other vessels to cancel the distress call that was made.

1. Press the **[CANCEL]** soft key, then press the **[YES]** soft key.

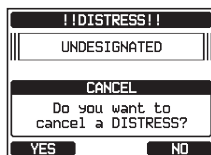

2. After the message for cancelling has been transmitted, press the **[OK]** soft key.

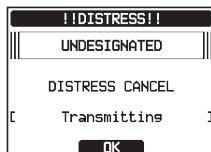

3. Press the **[FINISH]** soft key.

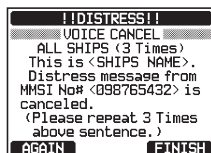

4. Press the **[QUIT]** soft key to return to radio operation.

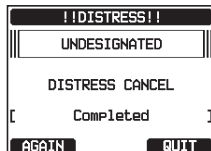

10.2.2 Receiving a DSC Distress Alert

1. When a DSC distress call is received, an emergency alarm sounds.
2. Press any key to stop the alarm.

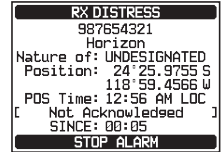

3. Rotate the **DIAL/ENT** knob to show information on the vessel in distress.

On the display you will notice 3 soft key selections. These selections are described below:

[ACCEPT]: Press this key to accept the DSC distress call and to switch to Channel 16.

Note: If a key is not pressed for 30 seconds or longer the radio will automatically switch to Channel 16. (“**AUTO CHANNEL CHANGE**” timer settings can be changed in “DSC SETUP” menu. The default setting is 30 sec.)

[PAUSE]: Press this key to temporarily disable automatic switching to Channel 16.

[QUIT]: Press this key to quit the automatic Channel 16 switching and revert to the last selected working channel.

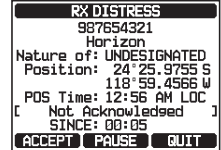

4. After accepting the call, press the **[TO WPT]** soft key to set the vessel in distress as a destination for navigation.

Note: You may change the waypoint name.

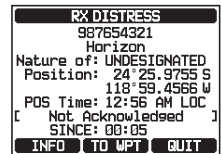

5. Rotate the **DIAL/ENT** knob key to select “**SAVE & GOTO**”, then press the **[SELECT]** soft key to change the display to the waypoint navigation screen. The display indicates the distance and direction of the distressed vessel, and the compass displays the distressed vessel by dot (●).

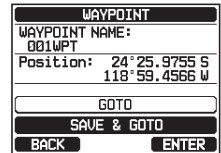

6. To stop navigating to a waypoint, press one of the soft keys, then press the **[STOP]** soft key. The radio is switched to the normal mode.

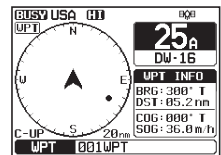

NOTE

- You must continue monitoring Channel 16 as a coast station may require assistance in the rescue attempt.
- When there is an unread distress alert, “✉” icon will appear on the display. You may review the unread distress alert from the DSC log, refer to the section “**10.11.2 Reviewing a Logged DSC RX Distress Call**”.
- Not all DSC radios can receive a DSC distress relay call.

10.3 ALL SHIPS CALL

The all ships call function allows contact to be established with DSC equipped vessels without having their MMSI in the individual calling directory. Also, priority for the call can be designated as “Safety” or “Urgency”.

SAFETY Call: This type of call is used to transmit boating safety information to other vessels. This message usually contains information about an overdue boat, debris in the water, loss of a navigation aid or an important meteorological message. This call is the same as saying “Securite, Securite, Securite”.

URGENCY Call: This type of call is used when a vessel may not truly be in distress, but have a potential problem that may lead to a distress situation. This call is the same as saying “PAN PAN, PAN PAN, PAN PAN” on Channel 16.

10.3.1 Transmitting an All Ships Call

1.  → “DSC CALL” → “ALL SHIPS CALL”
2. Rotate the **DIAL/ENT** knob to select the nature of call (“**SAFETY**” or “**URGENCY**”), then press the **[SELECT]** soft key.
3. In the INTERSHIP CH list, rotate the **DIAL/ENT** knob to select the operating channel “.” on which you want to communicate, then press the **[SELECT]** soft key. To select operating channels from all voice channels, press the **[MANUAL]** soft key.
4. Press the **[YES]** soft key to transmit the selected type of all ships call.
5. After the all ships call is transmitted, the transceiver will switch to the selected channel.
6. Listen to the channel to make sure it is not busy, then key the microphone and say “PAN PAN, PAN PAN, PAN PAN” or “Securite, Securite, Securite” depending on the priority of the call.

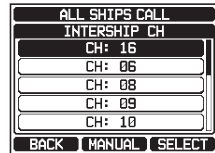
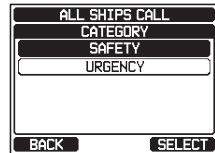

- Press the **[QUIT]** soft key to exit the all ships call menu.



10.3.2 Receiving an All Ships Call

- When an all ships call is received, an emergency alarm will sound.

The display shows the MMSI of the vessel transmitting the all ships call and the radio will change to the requested channel after 30 seconds (the default setting of "AUTO CHANNEL CHANGE").

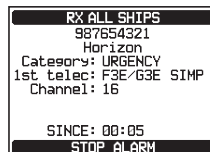

- Press any key to stop the alarm.
- Monitor the requested channel until the all ships voice communication is completed.

On the display you will notice 3 soft key selections. These selections are described below:



[ACCEPT]: Press this key to accept the DSC all ships call and to switch to requested channel.

Note: If a key is not pressed for 30 seconds or longer the radio will automatically change to the requested channel (the default setting of "AUTO CHANNEL CHANGE").

[PAUSE]: Press this key to temporarily disable automatic switching to the requested channel.

Note: In some cases, automatically switching to a requested channel might disrupt important ongoing communications. This feature allows commercial users to suspend channel switching and stay on the working channel selected before the all ships call was received.

[QUIT]: Press this key to quit the automatic channel switching and revert to the last selected working channel.

- Press the **[QUIT]** key to return to the channel display.



NOTE

When there is an unread all ships call, "✉" icon will appear on the display. You may review the unread all ships call from the DSC log, refer to the section "**10.11.2 Reviewing a Logged DSC RX Distress Call**".

10.4 INDIVIDUAL CALL

This feature allows the **GX6000** to contact another vessel with a DSC VHF radio and automatically switch the receiving radio to a desired communications channel. This feature is similar to calling a vessel on CH16 and requesting to go to another channel (switching to the channel is private between the two vessels). Up to 100 individual contacts may be programmed.

10.4.1 Setting up the Individual / Position Call Directory

The **GX6000** has a DSC directory that allows you to store a vessel or person's name and the associated MMSI number you wish to contact via individual calls, auto polling, position request, position report, and polling transmissions. To transmit an individual call you must program this directory with information of the persons you wish to call, similar to a cellular phone's telephone directory.

1.  **“SETUP”**  **“DSC SETUP”**  **“INDIVIDUAL DIRECTORY”**

2. Rotate the **DIAL/ENT** knob to select **“ADD”**, then press the **[SELECT]** soft key.

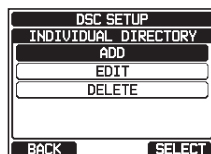

3. Rotate the **DIAL/ENT** knob to select **“NAME:”**, then press the **[SELECT]** soft key.

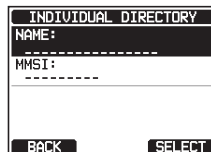

4. Rotate the **DIAL/ENT** knob to scroll through the first letter of the name of the vessel or person you want to reference in the directory.

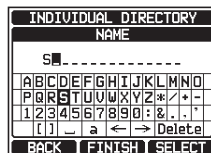

5. Press the **[SELECT]** soft key to store the first letter in the name and step to the next letter to the right.

6. Repeat steps 4 and 5 until the name is complete. The name can consist of up to fifteen characters, and if you do not use all fifteen characters, select **“→”** to move to the next space. This method can also be used to enter a blank space in the name.

If a mistake was made entering in the name, rotate the **DIAL/ENT** knob to select **“←”** or **“→”**, press the **[SELECT]** soft key until the wrong character is selected, then perform steps 4 and 5.

7. When finished entering the name (using fifteen characters or less), press the **[FINISH]** soft key to advance to the MMSI number entry.

8. Rotate the **DIAL/ENT** knob to select “**MMSI:**”, then press the **[SELECT]** soft key.
9. Rotate the **DIAL/ENT** knob to scroll through numbers, 0-9. To enter the desired number and move one space to the right by pressing the **[SELECT]** soft key. Repeat this procedure until all nine space of the MMSI number are entered.
If a mistake was made entering in the MMSI number, rotate the **DIAL/ENT** knob to select “←” or “→”, press the **[SELECT]** soft key until the wrong character is selected, then perform step 9.
10. When finished entering the MMSI number, press the **[FINISH]** soft key.
11. To store the entered data, rotate the **DIAL/ENT** knob to select “**SAVE**”, then press the **[SELECT]** soft key.
12. To enter another individual address, repeat steps 2 through 11.
13. Press the **CLEAR** key to return to radio operation.

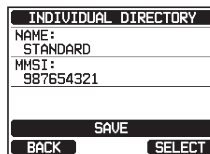

10.4.2 Setting up the Individual Call Reply

This menu item sets up the radio to automatically (default setting) or manually respond to a DSC individual call requesting you to switch to a working channel for voice communications. When “Manual” is selected the MMSI of the calling vessel is shown allowing you to see who is calling. This function is similar to caller id on a cellular phone.

1. **[MENU]** → “**SETUP**” → “**DSC SETUP**” → “**INDIVIDUAL REPLY**”

2. Rotate the **DIAL/ENT** knob to select “**AUTO**” or “**MANUAL**”.
3. Press the **[ENTER]** soft key to store the selected setting.
4. Press the **CLEAR** key to return to radio operation.

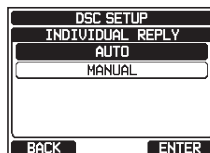

10.4.3 Enabling the Individual Call Acknowledgment

The radio can select either reply message “Able” (default) or “Unable” when the individual reply setting (described in the previous section) is set to “AUTOMATIC”.

1. **[MENU]** → “**SETUP**” → “**DSC SETUP**” → “**INDIVIDUAL ACK.**”

2. Rotate the **DIAL/ENT** knob to select “**ABLE**” or “**UNABLE**”.
3. Press the **[ENTER]** soft key to store the selected setting.
4. Press the **CLEAR** key to return to radio operation.

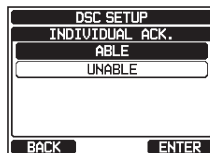

10.4.4 Transmitting an Individual Call

This feature allows the user to contact another vessel with a DSC radio. This feature is similar to calling a vessel on CH16 and requesting to go to another channel.

Individual Call using the Individual/Position Directory

1.  → "DSC CALL" → "INDIVIDUAL CALL"
2. Rotate the **DIAL/ENT** knob to select "**HISTORY**" or "**MEMORY**", then press the **[SELECT]** soft key.
3. Rotate the **DIAL/ENT** knob to select an individual you want to contact, press the **[SELECT]** soft key.
4. In the INTERSHIP CH list, rotate the **DIAL/ENT** knob to select the operating channel on which you want to communicate, then press the **[SELECT]** soft key. To select operating channels from all voice channels, press the **[MANUAL]** soft key.
5. Press the **[YES]** soft key to transmit the individual DSC signal.
6. When an individual call acknowledgment is received, the established channel is automatically changed to the channel which is selected on step 4 above and a ringing tone sounds.
7. Press the **[QUIT]** soft key to listen to the channel to make sure it is not busy, then press the microphone's **PTT** switch and talk into the microphone to communicate with the other vessel.

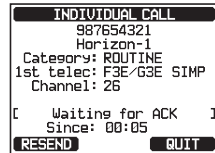
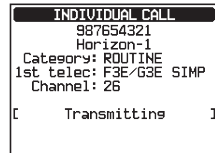
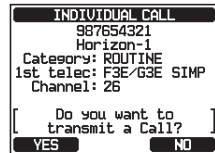
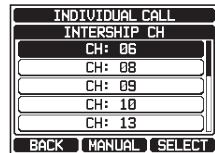
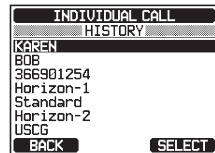
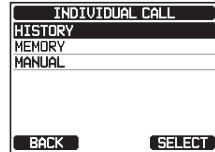

Individual Call by Manually Entering an MMSI

You may enter an MMSI number manually to contact without storing it in the individual directory.

1.  → "DSC CALL" → "INDIVIDUAL CALL"
2. Rotate the **DIAL/ENT** knob to select "**MANUAL**", then press the **[SELECT]** soft key.
3. Rotate the **DIAL/ENT** knob to select the first number of the MMSI which you want to contact, then press the **[SELECT]** soft key to step to the next number.
4. Repeat step 3 to set the MMSI number (nine digits). If a mistake was made entering in the MMSI number, rotate the **DIAL/ENT** knob to select "←" or "→", press the **[SELECT]** soft key until the wrong character is selected, then perform step 3.
5. When finished entering the MMSI number, press the **[FINISH]** soft key.
6. In the INTERSHIP CH list, rotate the **DIAL/ENT** knob to select the operating channel on which you want to communicate, then press the **[SELECT]** soft key. To select operating channels from all voice channels, press the **[MANUAL]** soft key.
7. Press the **[YES]** soft key to transmit the individual DSC signal.
8. When an individual call acknowledgment is received, the established channel is automatically changed to the channel which is selected on step 6 above and a ringing tone sounds.
9. Press the **[QUIT]** soft key to listen to the channel to make sure it is not busy, then press the microphone's **PTT** switch and talk into the microphone to communicate with the other vessel.

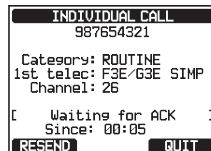
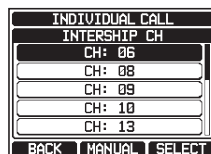
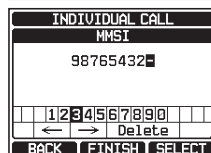
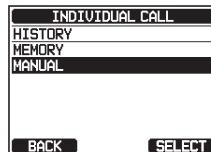

10.4.5 Receiving an Individual Call

When an individual DSC call is received, the radio will automatically respond (default setting) to the calling ship, and switch to the requested channel for voice communications. Refer to section “**10.4.2 Setting up the Individual Call Reply**” to change the reply to manual if you want to see who is calling before replying to the call.

Automatic reply:

1. When an individual call is received, an individual call ringing alarm sounds.
The radio automatically switches to the requested channel. The display shows the MMSI of the vessel calling.
2. Press any key to stop the alarm.
3. Monitor the requested channel until the message is completed.
Press the microphone’s **PTT** switch and talk into the microphone to communicate with the vessel that initiated the individual call.
4. Press the **[QUIT]** soft key to return to radio operation.

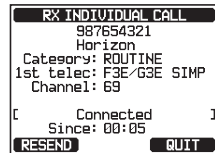

Manual reply:

1. When an individual call is received, an individual call ringing alarm sounds.
The display shows the MMSI of the vessel transmitting the individual call.
2. Press any key to stop the alarm.
3. On the display you will notice 3 soft key selections. These selections are described below:

[ACCEPT]: Press this key to accept the DSC individual call and to switch to requested channel.

[PAUSE]: Press this key to temporarily disable automatic switching to the requested channel.

Note: In some cases, automatically switching to a requested channel might disrupt important ongoing communications. This feature allows commercial users to suspend channel switching and stay on the working channel selected before the individual call was received.

[QUIT]: Press this key to quit the automatic channel switching and revert to the last selected working channel.

Note: If a key is not pressed for 30 seconds or longer the radio will automatically change to radio operation.

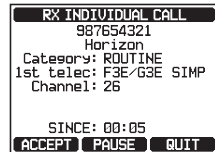
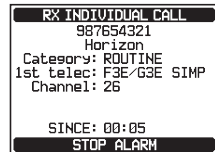

- After accepting the call, press the **[ABLE]** soft key to switch to the requested channel. (To inform the vessel that you are unable to respond, press the **[UNABLE]** soft key.)

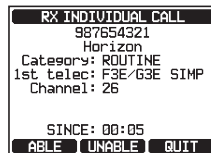

- Press the **[YES]** soft key to send an acknowledgment. Press the **[CHG CH]** soft key to change the channel for communication from the requested one.

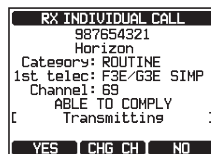

- Monitor the requested or specified channel until the message is completed.

Press the microphone's **PTT** switch and talk into the microphone to communicate with the vessel that initiated the individual call.

- Press the **[QUIT]** soft key to return to the channel display.

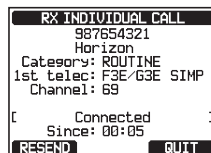

NOTE

When there is an unread individual call, “” icon will appear on the display. You may review the unread individual call from the DSC log, refer to the section “**10.11.2 Reviewing a Logged DSC RX Distress Call**”.

10.4.6 Setting up the Individual Call Ringer

When an individual call is received the radio's default setting will produce a ringing sound for 2 minutes. This selection allows the individual call ringer time to be changed.

-  → “**SETUP**” → “**DSC SETUP**” → “**INDIVIDUAL RING**”

- Rotate the **DIAL/ENT** knob to select ringing time of individual calls.
- Press the **[ENTER]** soft key to store the selected setting.
- Press the **CLEAR** key to return to radio operation.

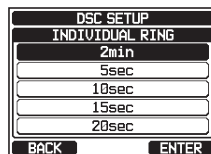

The **GX6000** has the capability to turn off the individual call ringer.

1. [MENU] → “**SETUP**” → “**DSC SETUP**” → “**DSC BEEP**”

2. Rotate the **DIAL/ENT** knob to select “**INDIVIDUAL CALL**”, then press the [SELECT] soft key.

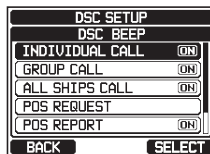

3. Rotate the **DIAL/ENT** knob to select “**OFF**”.

4. Press the [ENTER] soft key to store the selected setting.

5. Press the **CLEAR** key to return to radio operation.

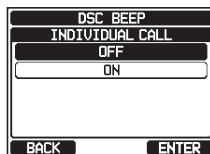

To enable the ringer tone, repeat the above procedure, rotating the **DIAL/ENT** knob to select “**ON**” in step 3 above.

10.5 GROUP CALL

This feature allows the user to contact a group of specific vessels using DSC radios with the group call function to automatically switch to a desired channel for voice communications. This function is very useful for yacht clubs and vessels traveling together that want to collectively make announcements on a predetermined channel. Up to 32 group MMSIs may be programmed.

10.5.1 Setting up a Group Call

For this function to operate, the same group MMSI (Maritime Mobile Service Identity Number) must be programmed into all the DSC VHF radios within the group of vessels that will be using this feature. To understand Group MMSI programming, first a ship MMSI has to be understood.

Ship MMSI: The first three digits called MID (Mobile Identity Group) of a ship MMSI denote the country where the ship’s MMSI is registered. The last 6 digits are specific to the ships ID.

Ship MMSI Example: If your MMSI is “366123456”, “366” is MID which denote the country and “123456” is your ships MMSI.

Group MMSI:

- Group MMSI numbers are not assigned by the FCC or other organizations licensed to assign ship MMSI numbers.
- The first digit of a group MMSI is always set to “0” by International rules. All Standard Horizon radios are preset so when programming a group MMSI the first digit is set to “0”.
- The USCG recommends programming the MID of a ship MMSI into the

Second, Third and Fourth digits of the group MMSI as it denotes the area the ship is located in.

- ❑ The last 5 digits are decided upon by persons in the group. This is an important step as all radios in the group must contain the same group MMSI so they can be contacted by each other. There is a chance that another group of vessels may program in the same group MMSI. If this happens, simply change one or more of the last 5 digits of the group MMSI.

1.  → “**SETUP**” → “**DSC SETUP**” → “**GROUP DIRECTORY**”

2. Rotate the **DIAL/ENT** knob to select “**ADD**”, then press the **[SELECT]** soft key.

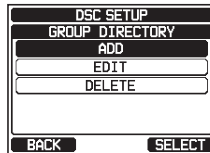

3. Rotate the **DIAL/ENT** knob to select “**GROUP NAME:**”, then press the **[SELECT]** soft key.

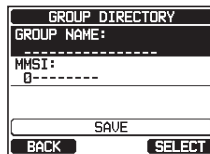

4. Rotate the **DIAL/ENT** knob to scroll through the first letter of the name of the group you want to reference in the directory.



5. Press the **[SELECT]** soft key to store the first letter in the name and step to the next letter to the right.
6. Repeat steps 4 and 5 until the name is complete. The name can consist of up to fifteen characters, if you do not use all eleven characters, select “→” to move to the next space. This method can also be used to enter a blank space in the name.

If a mistake was made entering in the name, rotate the **DIAL/ENT** knob to select “←” or “→”, press the **[SELECT]** soft key until the wrong character is selected, then perform steps 4 and 5.

7. When finished entering the group name (using fifteen characters or less), press the **[FINISH]** soft key to advance to the group MMSI number entry.

8. Rotate the **DIAL/ENT** knob to select “**MMSI:**”, then press the **[SELECT]** soft key.

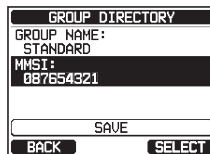

9. Rotate the **DIAL/ENT** knob to select the second number of the MMSI (nine digits: first digit permanently set to “0”) which you want to contact, then press the **[SELECT]** soft key to step to the next number. Repeat this procedure until all eight spaces of the MMSI number are entered.

If a mistake was made entering in the MMSI number, rotate the **DIAL/ENT** knob to select “←” or “→”, press the **[SELECT]** soft key until the wrong character is selected, then perform step 9.

10. When finished entering the MMSI number, press the **[FINISH]** soft key to confirm.
11. To store the data, select “**SAVE**”, then press the **[SELECT]** soft key.
12. To enter another group address, repeat steps 2 through 11.
13. Press the **CLEAR** key to return to radio operation.

10.5.2 Transmitting a Group Call

Group Call using the Group Directory

1.  → “**DSC CALL**” → “**GROUP CALL**”
2. Rotate the **DIAL/ENT** knob to select “**HISTORY**” or “**MEMORY**”, then press the **[SELECT]** soft key.
3. Rotate the **DIAL/ENT** knob to select a group you want to contact, then press the **[SELECT]** soft key
4. In the INTERSHIP CH list, rotate the **DIAL/ENT** knob to select the operating channel on which you want to communicate, then press the **[SELECT]** soft key. To select operating channels from all voice channels, press the **[MANUAL]** soft key.
5. Press the **[YES]** soft key to transmit the group call signal.
6. When the group call signal is sent, the display will be as shown in the illustration at the right.
7. After the group call is transmitted, all the radios in the group will switch to the designated channel.
8. Listen to the channel to make sure it is not busy, then press the microphone’s **PTT** switch to communicate with all of the vessels in the group.

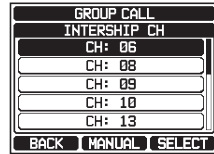
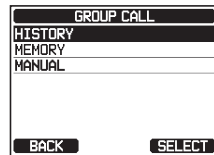

Group Call by Manually Entering an MMSI

This feature allows you to contact a group of vessels by entering in their group MMSI manually.

1.  → "DSC CALL" → "GROUP CALL"

2. Rotate the **DIAL/ENT** knob to select "**MANUAL**", then press the **[SELECT]** soft key.

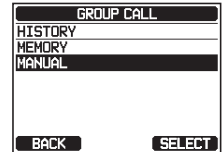

3. Rotate the **DIAL/ENT** knob to select the first number of the MMSI (nine digits: first digit permanently set to "0") which you want to contact, then press the **[SELECT]** soft key to step to the next number.



4. Repeat step 3 to set the MMSI number.

If a mistake was made entering in the MMSI number, rotate the **DIAL/ENT** knob to select "←" or "→", press the **[SELECT]** soft key until the wrong character is selected, then perform step.

5. When finished entering the MMSI number, press the **[FINISH]** soft key.

6. In the INTERSHIP CH list, rotate the **DIAL/ENT** knob to select the operating channel on which you want to communicate, then press the **[SELECT]** soft key. To select operating channels from all voice channels, press the **[MANUAL]** soft key.

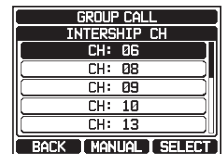

7. Press the **[YES]** soft key to transmit the group call signal.

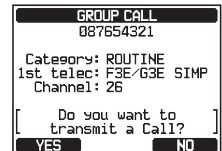

8. After the group call is transmitted, all the radios in the group will switch to the designated channel.



9. Listen to the channel to make sure it is not busy, then press the microphone's **PTT** switch to communicate with all of the vessels in the group.



10.5.3 Receiving a Group Call

1. When a group call is received, the **GX6000** will produce a ringing alarm sound.
2. The display shows the group MMSI number.
3. Press any key to stop the alarm.

On the display you will notice 3 soft key selections.

These selections are described below:

[ACCEPT]: Press this key to accept the group call and to switch to requested channel.

[PAUSE]: Press this key to temporarily disable automatic switching to the requested channel.

[QUIT]: Press this key to quit the automatic channel switching and revert to the last selected working channel.

4. If you want to respond, monitor the channel to make sure it is clear, then press the microphone's **PTT** switch and talk into the microphone to communicate with all of the vessels in the group.
5. Press the **[QUIT]** soft key to return to radio operation.

Note: If a key is not pressed for 30 seconds or longer the radio will automatically change to radio operation.

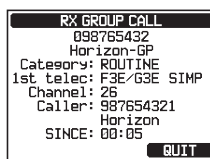
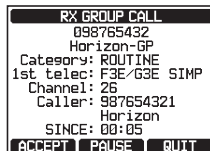

NOTE

When there is an unread group call, "☒" icon will appear on the display. You may review the unread group call from the DSC log, refer to the section "10.11.3 Reviewing Other Logged Calls".

10.5.4 Setting up the Group Call Ringer

The **GX6000** has the capability to turn off the group call ringer.

1. **[MENU]** → "SETUP" → "DSC SETUP" → "DSC BEEP"

2. Rotate the **DIAL/ENT** knob to select "GROUP CALL", then press the **[SELECT]** soft key.

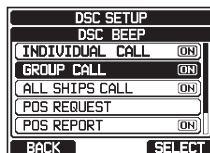

3. Rotate the **DIAL/ENT** knob to select “**OFF**”.
4. Press the **[ENTER]** soft key to store the selected setting.
5. Press the **CLEAR** key to return to radio operation.

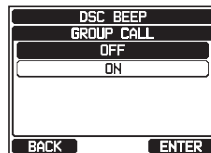

To re-enable the ringer tone, repeat the above procedure, rotating the **DIAL/ENT** knob to select “**ON**” in step 3 above.

10.6 POSITION REQUEST

Advancements in DSC have made it possible to poll the location of another vessel and show the position of that vessel on the display of the **GX6000**. Standard Horizon has taken this feature one step further, if a compatible GPS chart plotter is connected to the **GX6000**, the polled position of the vessel is shown on the display of the GPS chart plotter making it easy to navigate to the location of the polled vessel. This is a great feature for anyone wanting to know the position of another vessel. For example, your buddy that is catching fish or finding the location of a person you are cruising with.

NOTE

The other vessel must have an operating GPS receiver connected to its DSC radio and must not have its radio set to deny position requests. (Refer the section “**10.4 INDIVIDUAL CALL**” to enter information into the individual directory).

10.6.1 Setting up a Position Request Reply

The **GX6000** can be set up to automatically (default setting) or manually send your position when requested by another vessel. This selection is important if you are concerned about someone polling the position of your vessel that you may not want to. In the manual mode you will see the MMSI (Maritime Mobile Service Identity Number) or persons name shown on the display allowing you to choose to send your position to the requesting vessel.

1. **[MENU]** \Rightarrow “**SETUP**” \Rightarrow “**DSC SETUP**” \Rightarrow “**POSITION REPLY**”

2. Rotate the **DIAL/ENT** knob to select “**AUTO**” or “**MANUAL**”. In “**AUTO**” mode, after a DSC POS request is received, the radio will automatically transmit your vessel’s position. In “**MANUAL**” mode, the display of the **GX6000** will show who is requesting the position and the **[YES]** soft key on radio has to be pressed to send your position to the requesting vessel.

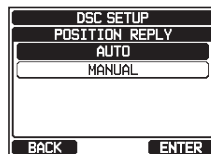

3. Press the **[ENTER]** soft key to store the selected setting.
4. Press the **CLEAR** key to return to radio operation.

10.6.2 Transmitting a Position Request to Another Vessel

Position Request using the Individual/Position Directory

Refer to section “**10.4 INDIVIDUAL CALL**” to enter information into the individual directory.

1. **[MENU]** → “**DSC CALL**” → “**POS REQUEST CALL**”
2. Rotate the **DIAL/ENT** knob to select “**HISTORY**” or “**MEMORY**”, then press the **[SELECT]** soft key.
3. Rotate the **DIAL/ENT** knob to select a name that was stored in the individual/position directory.
4. Press the **[SELECT]** soft key, then press the **[YES]** soft key to transmit the position request DSC call.
5. When the **GX6000** receives the position from the polled vessel it is shown on the radio display.
6. Press the **[QUIT]** soft key to return to radio operation.

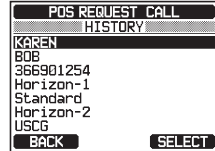
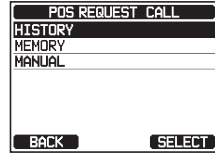

NOTE

If the **GX6000** does not receive position data from the polled vessel, the display will show “**NO POSITION DATA**”.

Position Request by Manually Entering an MMSI

This feature allows you to request the position of a vessel by manually entering the MMSI.

1. **[MENU]** → “**DSC CALL**” → “**POS REQUEST CALL**”

2. Rotate the **DIAL/ENT** knob to select “**MANUAL**”, then press the **[SELECT]** soft key.
3. Rotate the **DIAL/ENT** knob to select the first number of the MMSI (nine digits) which you want to contact, then press the **[SELECT]** soft key to step to the next number.
4. Repeat step 3 to set the MMSI number.
If a mistake was made entering in the MMSI number, rotate the **DIAL/ENT** knob to select “←” or “→”, press the **[SELECT]** soft key until the wrong character is selected, then perform step 3.
5. When finished entering the MMSI number, press the **[FINISH]** soft key.
6. Press the **[YES]** soft key to transmit the position request DSC call.
7. When the **GX6000** receives the position from the polled vessel it is shown on the radio display.
8. Press the **[QUIT]** soft key to return to radio operation.

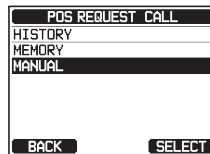

NOTE

The received position from the polled vessel can be transferred to a GPS chart plotter via NMEA DSC and DSE sentences.

10.6.3 Receiving a Position Request

1. When a position request call is received from another vessel, a ringing sound will be produced, and the display will be as shown in the illustration at the right.
2. Press any key to stop the alarm.
3. To send your vessel’s position to the requesting vessel, press the **[REPLY]** soft key.
Or to exit from position request display, press the **[QUIT]** soft key.



- Press the **[QUIT]** soft key to return to the channel display.



NOTE

When there is an unread position request call, “✉” icon will appear on the display. You may review the unread individual call from the DSC log, refer to the section “**10.11.3 Reviewing Other Logged Calls**”.

10.6.4 Manual Input of Position Information

If the **GX6000** is located in an area where GPS reception is limited when you are going to reply to the received position request, you may manually input your location (latitude and longitude) and time to be sent.

- [MENU]** → “MMSI/POS INFO”

- Press the **[POS/TM]** soft key.

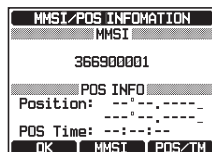

- Rotate the **DIAL/ENT** knob to select the first number of latitude, then press the **[SELECT]** soft key to step to the next number.

- Repeat step 3 to set the position and time.

If a mistake was made, rotate the **DIAL/ENT** knob to select “←” or “→”, press the **[SELECT]** soft key until the wrong character is selected, then perform step 3.

- When finished programming the position and time, press the **[FINISH]** soft key. The display will return to the previous screen.

- Press the **[OK]** soft key.

- Press the **CLEAR** key to return to radio operation.

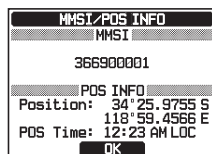
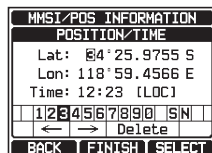

10.6.5 Setting up a Position Request Ringer

The **GX6000** has the capability to turn off the position request ringer.

1. 
2. Rotate the **DIAL/ENT** knob to select “**POS REQUEST**”, then press the **[SELECT]** soft key.
3. Rotate the **DIAL/ENT** knob to select “**OFF**”.
4. Press the **[ENTER]** soft key to store the selected setting.
5. Press the **CLEAR** key to return to radio operation.

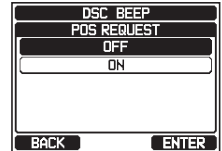
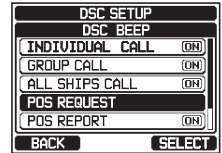

To enable the ringer tone, repeat the above procedure, rotating the **DIAL/ENT** knob to select “**ON**” in step 3 above.

10.7 POSITION REPORT

The feature is similar to position request, however instead of requesting a position of another vessel this function allows you to send your position to another vessel.

10.7.1 Transmitting a DSC Position Report Call

DSC Position Report Call using the Individual/Position Directory

Refer to section “**10.4 INDIVIDUAL CALL**” to enter information into the individual directory.

1. 
2. Rotate the **DIAL/ENT** knob to select “**HISTORY**” or “**MEMORY**”, then press the **[SELECT]** soft key.
3. Rotate the **DIAL/ENT** knob to select the name in the directory, then press the **[SELECT]** soft key.

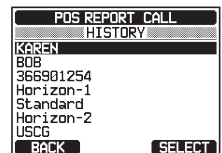
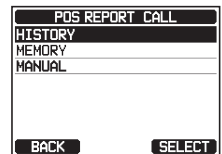

- If you want to change the position displayed, press the **[POS/TM]** soft key to go to the position information input screen. After inputting new position information, press the **[FINISH]** soft key to confirm.

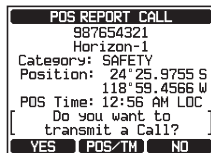

- Press the **[YES]** soft key to send your position to the selected vessel.
- Press the **[QUIT]** soft key to return to radio operation.

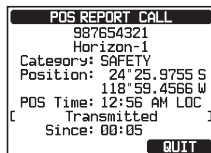

DSC Position Report Call by Manually Entering an MMSI

This feature allows you to send your position to another vessel by manually entering the MMSI of the ship you want to send your position to.

- [MENU]** → “DSC CALL” → “POS REPORT CALL”

- Rotate the **DIAL/ENT** knob to select “MANUAL”, then press the **[SELECT]** soft key.

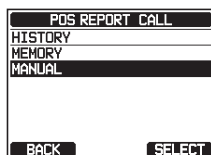

- Rotate the **DIAL/ENT** knob to select the first number of the MMSI which you want to contact, then press the **[SELECT]** soft key to step to the next number.
- Repeat step 3 to set the MMSI number.

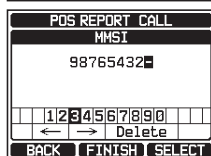

- If a mistake was made entering in the MMSI number, rotate the **DIAL/ENT** knob to select “←” or “→”, press the **[SELECT]** soft key until the wrong character is selected, then perform step 3.

- When finished entering the MMSI number, press the **[FINISH]** soft key.
- If you want to change the position displayed, press the **[POS/TM]** soft key to go to the position information input screen. After inputting new position information, press the **[FINISH]** soft key to confirm.

- Press the **[YES]** soft key to send your position to the selected vessel.

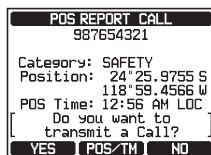

- Press the **[QUIT]** soft key to return to radio operation.

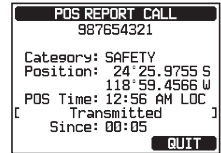

10.7.2 Receiving a DSC Position Report Call

When another vessel transmits their vessels location to the **GX6000** the following will happen:

- When a position report call is received from another vessel, a ringing sound will be produced.
- Press any key to stop ringing.
- Press the **[INFO]** soft key to see more detailed position information of the station.
- To exit to radio mode, press the **[QUIT]** soft key.

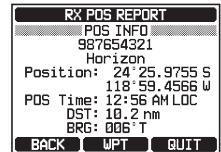
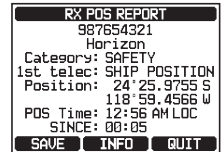
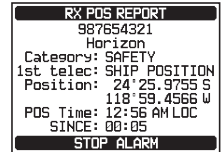

10.7.3 Navigating to the Reported Position

The **GX6000** has a feature that allows you to navigate to a received position report call by using the compass display. Navigating to the position of a position report call may be enabled by the procedure below.

- After the position report call has been received, press the **[INFO]** soft key.
- Press the **[WPT]** soft key.

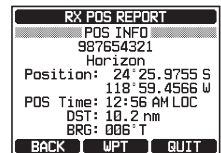
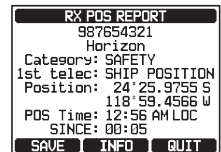

- The display indicates the distance and direction of the received vessel, and the compass displays the received vessel with a dot (●).

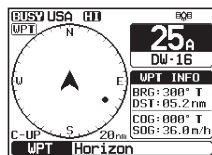

Stopping Navigation to the Reported Position

- Press one of the soft keys to show the key selections.
- Press the **[STOP]** soft key. The radio will stop navigating to the waypoint and the normal VHF display will be shown.

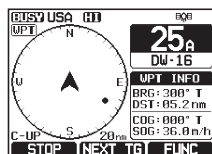

10.7.4 Saving the Reported Position as a Waypoint

The **GX6000** can save a position report call in the radio's memory as a waypoint.

- After the position report call has been received, press the **[SAVE]** soft key.
- If you want to change the name of the waypoint, rotate the **DIAL/ENT** knob to select "NAME", then press the **[SELECT]** soft key.
- Enter the name of the waypoint you want to reference in the directory. For details, refer to "10.4.1 Setting up the Individual / Position Call Directory".
- Rotate the **DIAL/ENT** knob to select "SAVE", then press the **[SELECT]** soft key to save the waypoint into memory.
- Press the **[OK]** soft key to return to the position report display.

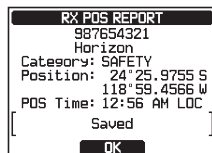
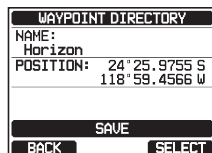
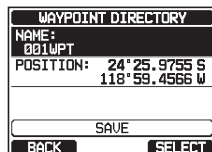
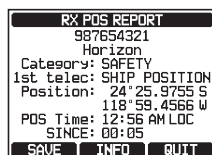

Navigating to a Saved Waypoint

Refer to section “11.1.1 Starting and Stopping Navigation” for details.

10.7.5 Setting up a Position Report Ringer

The **GX6000** has the capability to turn off the position report ringer.

1.  → “**SETUP**” → “**DSC SETUP**” → “**DSC BEEP**”
2. Rotate the **DIAL/ENT** knob to select “**POS REPORT**”, then press the **[SELECT]** soft key.
3. Rotate the **DIAL/ENT** knob to select “**OFF**”.
4. Press the **[ENTER]** soft key to store the selected setting.
5. Press the **CLEAR** key to return to radio operation.

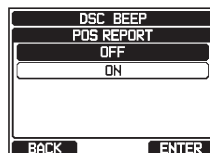
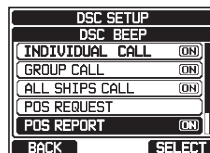

To re-enable the ringer tone, repeat the above procedure, rotating the **DIAL/ENT** knob to select “**ON**” in the step 3 above.

10.8 POLLING CALL

The **GX6000** has the capability to track another vessel.

10.8.1 Transmitting a Polling Call to a Vessel

Polling Call using the Individual/Position Call Directory

1.  → “**DSC CALL**” → “**POLLING CALL**”
2. Rotate the **DIAL/ENT** knob to select “**HISTORY**” or “**MEMORY**”, then press the **[SELECT]** soft key.
3. Rotate the **DIAL/ENT** knob to select a name that was stored in the individual/position call directory, then press the **[SELECT]** soft key.

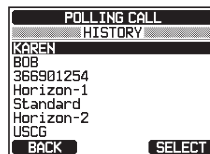
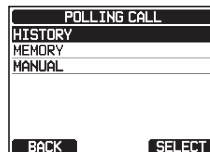

4. Press the **[YES]** soft key to transmit the polling call.
5. After a polling call is transmitted, if the reply signal is not received, "Waiting for ACK" is shown on the display which means the **GX6000** is waiting for the vessel you called to send an acknowledgement.
6. To transmit the call again, press the **[RESEND]** soft key.
7. Press the **[QUIT]** soft key to return to radio operation.

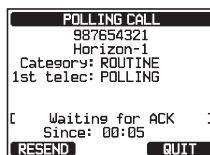
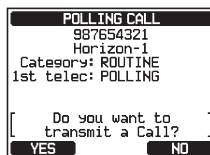

Polling Call by Manually Entering an MMSI

This feature allows you to contact a vessel by manually entering the MMSI of the ship you want to track.

1. **[MENU]** → "DSC CALL" → "POLLING CALL"

2. Rotate the **DIAL/ENT** knob to select "MANUAL", then press the **[SELECT]** soft key.

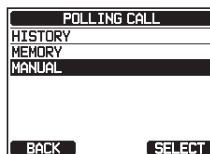

3. Rotate the **DIAL/ENT** knob to select the first number in the MMSI and press the **[SELECT]** soft key.

4. Repeat step 3 until all the digits of the MMSI are shown on the display.

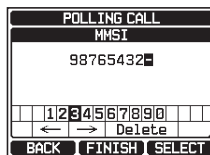

5. If a mistake was made entering in the MMSI number, rotate the **DIAL/ENT** knob to select "←" or "→", press the **[SELECT]** soft key until the wrong character is selected, then perform step 3.

6. When finished entering the MMSI number, press the **[FINISH]** soft key.

7. Press the **[YES]** soft key to transmit the polling call.

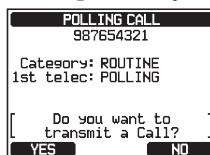

8. Press the **[QUIT]** soft key to return to radio operation.

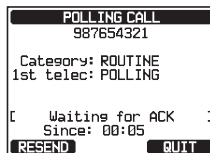

10.8.2 Receiving a Polling Call

When another vessel transmits a polling call to the **GX6000** the following will happen:

1. When a polling call is received, the radio will automatically respond to the calling vessel.
2. To exit from the polling call display, press the **[QUIT]** soft key.

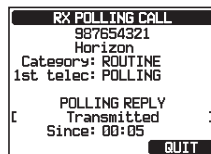

10.9 AUTO POSITION POLLING

The **GX6000** has the capability to automatically track seven vessels programmed into the individual directory, or to automatically send your position information to the programmed stations.

10.9.1 Setting up the Polling Operation

1. **[MENU]** → “**SETUP**” → “**DSC SETUP**” → “**AUTO POSITION POLLING**”

2. Rotate the **DIAL/ENT** knob to select the desired operation (AUTO POS REQUEST and AUTO POS REPORT), and press the **[ENTER]** soft key.
3. Press the **CLEAR** key to return to radio operation.

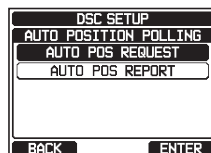

10.9.2 Setting up the Polling Time Interval

1. **[MENU]** → “**SETUP**” → “**DSC SETUP**” → “**AUTO POS INTERVAL**”

2. Rotate the **DIAL/ENT** knob to select “**AUTO POS INTERVAL**”, then press the **[SELECT]** soft key.
3. Rotate the **DIAL/ENT** knob to select the desired interval time (30 second, 1, 2, 3, and 5 minutes) and press the **[ENTER]** soft key.
4. Press the **CLEAR** key to return to radio operation.

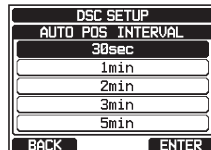
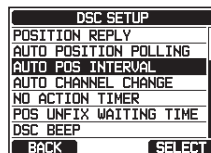

10.9.3 Selecting Vessels to be Automatically Polled

NOTE

The radio uses the individual directory to select vessels to be automatically polled. Refer to section “10.4.1 Setting up the Individual / Position Call Directory” and to enter MMSI of vessels you want to poll before proceeding.

1.  → “DSC CALL” → “AUTO POS POLLING”

2. Rotate the **DIAL/ENT** knob to select “**SELECTED ID**”, then press the **[SELECT]** soft key.

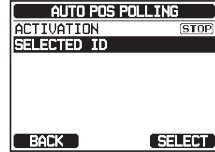

3. The radio will show a blank row highlighted when you select the vessel for the first time. Press the **[SELECT]** soft key.

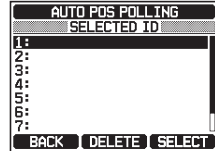

4. The radio will show the vessels programmed in the individual directory. Rotate the **DIAL/ENT** knob to select the desired vessel, then press the **[ENTER]** soft key.

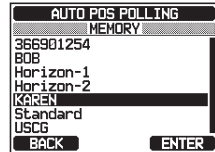

5. For more entries, rotate the **DIAL/ENT** knob to select a blank row, press the **[SELECT]** soft key, then perform step 4.

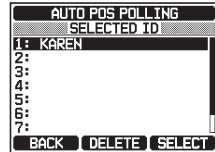

6. When finished, press the **CLEAR** key to exit to the radio mode.

10.9.4 Enabling/Disabling Auto POS Polling

1.  → “DSC CALL” → “AUTO POS POLLING”

2. Rotate the **DIAL/ENT** knob to select the “**ACTIVATION**”, then press the **[SELECT]** soft key.

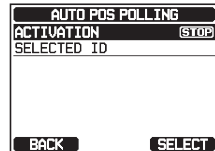

3. Rotate the **DIAL/ENT** knob to select “**START**” to enable transmissions or “**STOP**” to disable, then press the **[ENTER]** soft key.

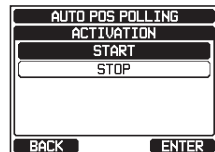

4. Press the **CLEAR** key to return to radio operation.
5. Auto POS Polling starts and “[A]” icon will light up on the screen.



10.10 DSC TEST

This function is used to contact another DSC equipped vessel to ensure the DSC functions of the radio are operating.

NOTE

To use this feature, the radio that will receive the test call also needs to have the DSC Test feature.

To perform the DSC test you will need to enter the MMSI of another vessel into the individual directory or manually enter in the MMSI using the procedure below.

10.10.1 Programming MMSI into Individual Directory

Refer to section “10.4.1 Setting up the Individual / Position Call Directory”.

10.10.2 Transmitting a DSC Test to Another Vessel

DSC Test call by using Individual/Position Directory

1. → “DSC CALL” → “DSC TEST CALL”
2. Rotate the **DIAL/ENT** knob to select “**HISTORY**” or “**MEMORY**”, then press the **[SELECT]** soft key.
3. Rotate the **DIAL/ENT** knob to select the ship name, then press the **[SELECT]** soft key.
4. Press the **[YES]** soft key to transmit the DSC test call to the other vessel.
5. Press the **[QUIT]** soft key to return to radio operation.

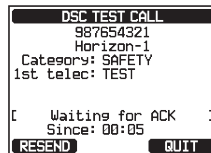
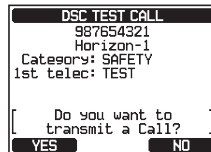
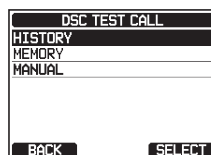

DSC Test Call by Manually Entering an MMSI

1. [MENU] → "DSC CALL" → "DSC TEST CALL" → "MANUAL"

2. Rotate the **DIAL/ENT** knob to select "**MANUAL**", then press the **[SELECT]** soft key.

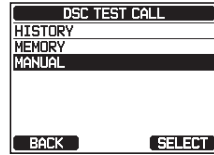

3. Rotate the **DIAL/ENT** knob to select the first digit in the MMSI, then press the **[SELECT]** soft key.

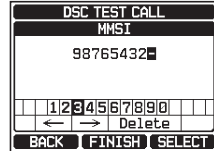

4. Repeat step 3 until all the numbers of the MMSI are shown on the display.

5. Press the **[FINISH]** soft key to show the test call page.

6. Press the **[YES]** soft key to transmit the DSC test call to the other vessel.



7. Press the **[QUIT]** soft key to return to radio operation.



NOTE

After the radio receives a test call reply from the vessel that was called, the radio will ring and show "RX TEST CALL" display, which confirms the radio you called has received the test call.

10.10.3 Receiving a DSC Test Call

When another vessel transmits a DSC Test call to the **GX6000** the following will happen:

1. When a DSC Test call is received, the radio will automatically respond to the calling vessel.

2. To exit from the DSC Test call display, press the **[QUIT]** soft key.

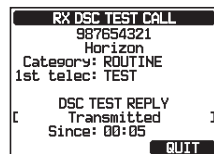

10.11 DSC LOG OPERATION

The **GX6000** logs transmitted calls, received DSC distress calls, and other calls (individual, group, all ships, etc.). The DSC log feature is similar to an answer machine where calls are recorded for review and a “☒” icon will appear on the radio's display. The **GX6000** can store up to 100 transmitted calls, up to the latest 50 distress calls, and up to the latest 100 other calls (individual, group, all ships, position report, position request ack, test call ack, and polling calls).

NOTE

When the “DSC LOG” menu is selected, the **GX6000** may display high-priority logged call automatically.

10.11.1 Reviewing and Resending a Transmitted Logged Call

The **GX6000** allows transmitted logged calls to be reviewed and to resend the call.

1.  → “DSC CALL” → “DSC LOG”
2. Rotate the **DIAL/ENT** knob to select “**TRANSMITTED**”, then press the **[SELECT]** soft key.
3. Rotate the **DIAL/ENT** knob to select the station (name or MMSI number) you want to review and/or resend the call.
4. Press the **[SELECT]** soft key to review details for the selected station.
5. Depending on the type of the DSC LOG selected in step 3, you can check the information of the LOG by pressing the **[INFO]** soft key and can reply by pressing the **[CALL]** soft key.

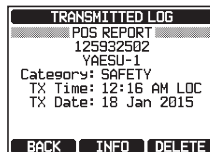
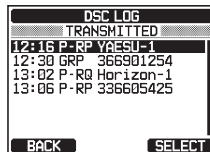
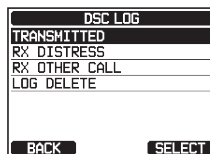

10.11.2 Reviewing a Logged DSC RX Distress Call

The **GX6000** allows logged DSC RX distress call to be reviewed.

1.  → "DSC CALL" → "DSC LOG" → "RX DISTRESS"

2. Rotate the **DIAL/ENT** knob to select the station (name or MMSI number) you want to review and/or relay the distress call to other vessels.

Note: When there is an unread received call, "✉" icon will appear to the left of the logged call.

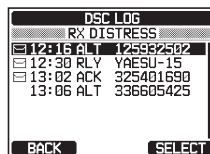

DSC LOG	
RX DISTRESS	
✉ 12:15 ALL	125932502
12:30 RLY	YAESU-15
13:02 ACK	325401690
13:06 ALT	336605425

3. Press the **[SELECT]** soft key to review details for the selected station.
4. Press the **[INFO]** soft key to display more information or press the **[BACK]** soft key to go back to the received DSC distress call list.

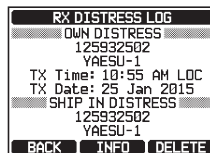

RX DISTRESS LOG	
OWN DISTRESS	
125932502	
YAESU-1	
TX Time: 10:55 AM LOC	
TX Date: 25 Jan 2015	
SHIP IN DISTRESS	
125932502	
YAESU-1	

10.11.3 Reviewing Other Logged Calls

1.  → "DSC CALL" → "DSC LOG" → "RX OTHER CALL"

2. Rotate the **DIAL/ENT** knob to select the station (name or MMSI number) you want to review and/or call back.

Note: When there is an unread received call, "✉" icon will appear to the left of the logged call.

3. Press the **[SELECT]** soft key to review details for the selected station.
4. Press the **[REPLY]** soft key to reply to the call or press the **[BACK]** soft key to go back to the received call list.

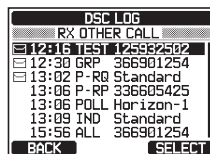

DSC LOG	
RX OTHER CALL	
✉ 12:15 TEST	125932502
12:30 GRP	366901254
13:02 P-RQ	Standard
13:06 P-RP	336605425
13:06 POLL	Horizon-1
13:09 IND	Standard
15:56 ALL	366901254

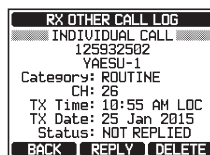

RX OTHER CALL LOG	
INDIVIDUAL CALL	
125932502	
YAESU-1	
Category: ROUTINE	
CH: 26	
TX Time: 10:55 AM LOC	
TX Date: 25 Jan 2015	
Status: NOT REPLIED	

10.11.4 Deleting Logged Calls from the DSC Log Directory

1.  → "DSC CALL" → "DSC LOG" → "LOG DELETE"

2. Rotate the **DIAL/ENT** knob to select the category (“TRANSMITTED”, “RX DISTRESS”, “RX OTHER CALL” or “ALL LOG”) to be deleted.
3. Press the **[SELECT]** soft key.
The display will show “Do you want to delete the LOG?”.
4. Press the **[YES]** soft key. (To cancel, press the **[NO]** soft key.)
5. Press the **CLEAR** key to return to radio operation.

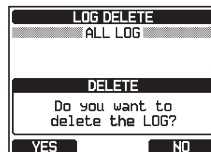
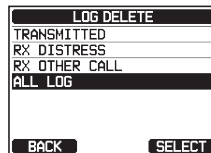

NOTE

The procedure above will delete all logged calls of the selected category at one time.

To delete logged calls one by one, review the details of the call you want to delete, then press the **[DELETE]** soft key.

10.12 DSC LOOP BACK OPERATION

The **GX6000** has a self-test feature for DSC call.

1. → “DSC CALL” → “DSC LOOP BACK”

2. Press the **[YES]** soft key to start a test. (To cancel, press the **[NO]** soft key.)

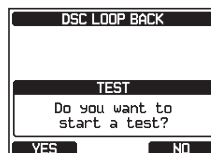

The display will show “Passed!” if the DSC feature properly operates, then press the **[OK]** soft key to the “DSC CALL” menu.

3. Press the **CLEAR** key to return to radio operation.

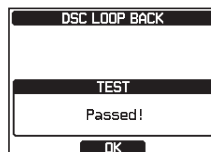

11 NAVIGATION

The **GX6000** is capable of storing up to 250 waypoints for navigation using the compass page.

You can also navigate to DSC distress calls with position or a position received from another DSC radio using DSC polling.

11.1 WAYPOINT OPERATION

11.1.1 Starting and Stopping Navigation

Navigation by Using the Waypoint Directory

1. **[MENU]** \Rightarrow **"NAVI"** \Rightarrow **"WAYPOINT"**

2. Rotate the **DIAL/ENT** knob to select the desired category (**"HISTORY"** or **"MEMORY"**), then press the **[SELECT]** soft key.

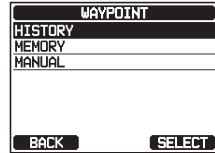

3. Rotate the **DIAL/ENT** knob to select a waypoint, then press the **[SELECT]** soft key. The navigation screen will appear.

The screen includes the distance and direction to the destination, and the waypoint is indicated by a dot (●) inside the compass.

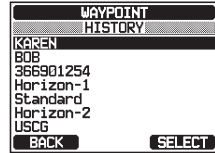

4. Press one of the soft keys to show the key selections. Press the **[STOP]** soft key to stop the navigation.

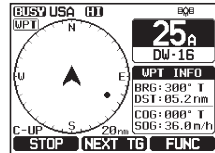
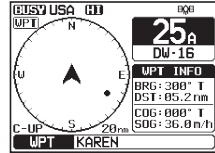

Navigation by Manually Entering a Waypoint

1. **[MENU]** \Rightarrow **"NAVI"** \Rightarrow **"WAYPOINT"**

2. Rotate the **DIAL/ENT** knob to select **"MANUAL"**, then press the **[SELECT]** soft key.

3. If you want to give the waypoint an easy-to-find name, rotate the **DIAL/ENT** knob to select **"NAME:"**, press the **[SELECT]** soft key, then enter the name. For details, refer to **"10.4.1 Setting up the Individual / Position Call Directory"**.

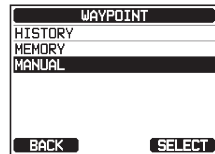

- Rotate the **DIAL/ENT** knob to select “**POSITION:**”, then press the **[SELECT]** soft key.

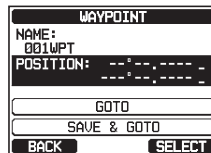

- Rotate the **DIAL/ENT** knob to select the first number of latitude, then press the **[SELECT]** soft key to step to the next number.

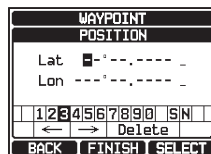

- Repeat step 5 to set the position.

If a mistake was made, rotate the **DIAL/ENT** knob to select “←” or “→”, press the **[SELECT]** soft key until the wrong character is selected, then perform step 5.

- When finished programming the position, press the **[FINISH]** soft key. The display will return to the previous screen.

- Rotate the **DIAL/ENT** knob to select “**SAVE & GOTO**”, then press the **[SELECT]** soft key. To set the Waypoint as a temporary destination without saving and start the navigation, select “**GOTO**” and press the **[SELECT]** soft key.

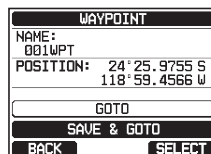

The navigation screen will appear.

The screen includes the distance and direction to the destination, and the waypoint is indicated by a dot (●) inside the compass.

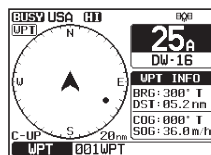

- Press one of the soft keys to show the key selections. Press the **[STOP]** soft key to stop the navigation.

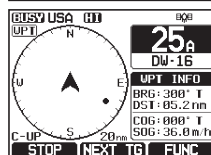

11.1.2 Setting Up Waypoint Directory

Marking a Position

This feature allows the radio to mark the current position of the vessel.

- [MENU]** → “**SETUP**” → “**WAYPOINT SETUP**” → “**MARK POSITION**”

- Rotate the **DIAL/ENT** knob to select “**NAME:**”, then press the **[SELECT]** soft key.

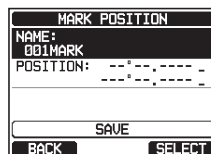

- Enter the waypoint name by rotating the **DIAL/ENT** knob and the **[SELECT]** soft key.

When finished entering the name (using fifteen characters or less), press the **[FINISH]** soft key.

- If you want to modify the position, rotate the **DIAL/ENT** knob to select “**POSITION:**”, press the **[SELECT]** soft key, then enter the new coordinates. When finished modifying the position, press the **[FINISH]** soft key.
- Rotate the **DIAL/ENT** knob to select “**SAVE**”, then press the **[SELECT]** soft key to save the mark position into memory.
- Press the **CLEAR** key to return to radio operation.

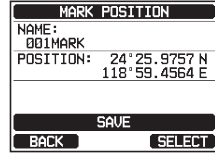

Adding a Waypoint

- [MENU]** → “**SETUP**” → “**WAYPOINT SETUP**” → “**WAYPOINT DIRECTORY**”

- Rotate the **DIAL/ENT** knob to select “**ADD**”, then press the **[SELECT]** soft key.

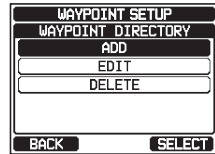

- Rotate the **DIAL/ENT** knob to select “**NAME:**”, then press the **[SELECT]** soft key.

- Enter the waypoint name by rotating the **DIAL/ENT** knob and the **[SELECT]** soft key.

When finished entering the name (using fifteen characters or less), press the **[FINISH]** soft key.

- Rotate the **DIAL/ENT** knob to select “**POSITION:**”, press the **[SELECT]** soft key, then enter the coordinates.

When finished entering the position, press the **[FINISH]** soft key.

- Rotate the **DIAL/ENT** knob to select “**SAVE**”, then press the **[SELECT]** soft key to save the waypoint into memory.

- Press the **CLEAR** key to return to radio operation.

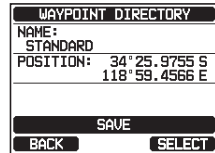
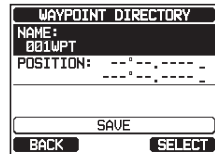

Editing a Waypoint

This function allows a previously entered waypoint to be edited.

- [MENU]** → “**SETUP**” → “**WAYPOINT SETUP**” → “**WAYPOINT DIRECTORY**”

- Rotate the **DIAL/ENT** knob to select “**EDIT**”, then press the **[SELECT]** soft key.

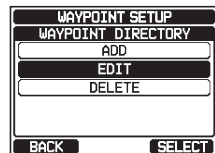

3. Rotate the **DIAL/ENT** knob to select the waypoint to be edited, then press the **[SELECT]** soft key to show the waypoint input display.
4. Rotate the **DIAL/ENT** knob to select “**NAME:**” or “**POSITION:**”, then press the **[SELECT]** soft key.
5. Rotate the **DIAL/ENT** knob to select “←” or “→”, press the **[SELECT]** soft key until the character to be changed is selected, then enter a new character.
6. Repeat step 5 until the waypoint is updated. When finished editing, press the **[FINISH]** soft key.
7. Rotate the **DIAL/ENT** knob to select “**SAVE**”, then press the **[SELECT]** soft key to store the edited waypoint into memory.
8. Press the **CLEAR** key to return to radio operation.

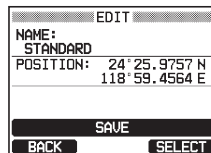
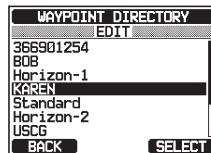

Deleting a Waypoint

1. **[MENU]** → “**SETUP**” → “**WAYPOINT SETUP**” → “**WAYPOINT DIRECTORY**”
2. Rotate the **DIAL/ENT** knob to select “**DELETE**”, then press the **[SELECT]** soft key.
3. Rotate the **DIAL/ENT** knob to select the waypoint to be deleted, then press the **[SELECT]** soft key.
4. Confirm the waypoint to be deleted, rotate the **DIAL/ENT** knob to select “**OK**”, then press the **[SELECT]** soft key.
5. Press the **CLEAR** key to return to radio operation.

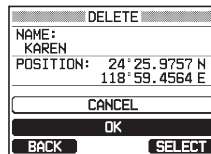
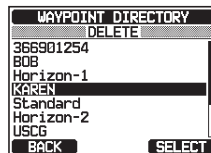
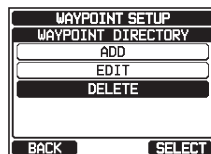

Saving a DSC Position Call as a Waypoint

When a position is received from another DSC radio the **GX6000** allows the position to be saved as a waypoint.

Refer to section “**10.7.4 Saving the Reported Position as a Waypoint**” for details.

11.1.3 Selecting the Display Range

This menu item allows setting of the range on the compass display.

1. [MENU] → "SETUP" → "WAYPOINT SETUP" → "DISPLAY RANGE"

2. Rotate the **DIAL/ENT** knob to select desired range. (Unit of measure depends on the settings in the GPS SETUP menu. Refer to section "18.7 UNITS OF MEASURE".)
3. Press the [ENTER] soft key to store the selected setting.
4. Press the **CLEAR** key to return to radio operation.

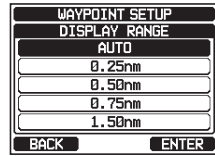

11.1.4 Selecting the Arrival Range

This menu item sets the distance to alert you when you are within the specified arrival range of the waypoint.

1. [MENU] → "SETUP" → "WAYPOINT SETUP" → "ARRIVAL RANGE"

2. Rotate the **DIAL/ENT** knob to select desired range. (Unit of measure depends on the settings in the GPS SETUP menu. Refer to section "18.7 UNITS OF MEASURE".)
3. Press the [ENTER] soft key to store the selected setting.
4. Press the **CLEAR** key to return to radio operation.

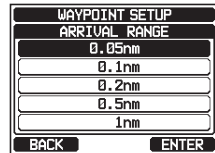

11.2 ROUTING OPERATION

The **GX6000** allows you to set 1 to 15 waypoints along the route.

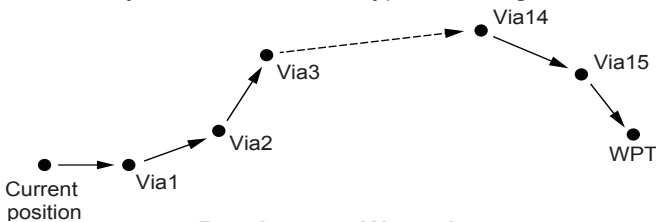

Routing to a Waypoint

11.2.1 Setting Up Routing Directory

NOTE

All the destinations and via-points must be programmed as waypoints in the **GX6000** memory. Refer to section "11.1.2 Setting Up Waypoint Directory".

Adding a Route

1.  → "SETUP" → "WAYPOINT SETUP" → "ROUTE DIRECTORY"

2. Rotate the **DIAL/ENT** knob to select "ADD", then press the **[SELECT]** soft key.

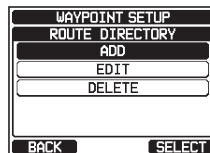

3. Rotate the **DIAL/ENT** knob to select "NAME:", then press the **[SELECT]** soft key.

4. Enter the route name by rotating the **DIAL/ENT** knob and the **[SELECT]** soft key.

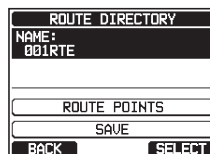

When finished entering the name (using fifteen characters or less), press the **[FINISH]** soft key.

5. Rotate the **DIAL/ENT** knob to select "ROUTE POINTS", press the **[SELECT]** soft key.

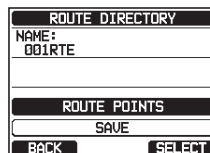

6. Rotate the **DIAL/ENT** knob to select "WPT:", then press the **[SELECT]** soft key.

7. Rotate the **DIAL/ENT** knob to select a waypoint, then press the **[SELECT]** soft key.



8. Rotate the **DIAL/ENT** knob to select "Via1", then press the **[SELECT]** soft key.

9. Rotate the **DIAL/ENT** knob to select a waypoint, then press the **[SELECT]** soft key.



10. Repeat steps 8 and 9 to add more via-points.

11. Press the **[BACK]** soft key.

12. Rotate the **DIAL/ENT** knob to select "SAVE", then press the **[SELECT]** soft key to store the route into memory.

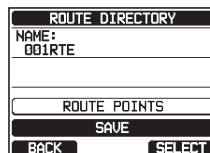

13. Press the **CLEAR** key to return to radio operation.

Editing a Route

This function allows a previously entered route to be edited.

1.  → "SETUP" → "WAYPOINT SETUP" → "ROUTE DIRECTORY"

2. Rotate the **DIAL/ENT** knob to select **“EDIT”**, then press the **[SELECT]** soft key.
3. Rotate the **DIAL/ENT** knob to select the route to be edited, then press the **[SELECT]** soft key to show the route input display.
4. Perform steps 3 to 11 of the previous page until the route is updated.
5. Rotate the **DIAL/ENT** knob to select **“SAVE”**, then press the **[SELECT]** soft key to store the edited route into memory.
6. Press the **CLEAR** key to return to radio operation.

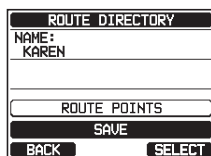
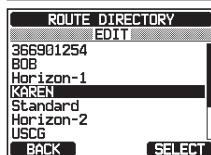
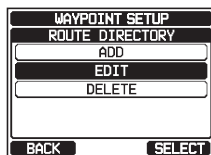

Deleting a Route

1. **[MENU]** → **“SETUP”** → **“WAYPOINT SETUP”** → **“ROUTE DIRECTORY”**

2. Rotate the **DIAL/ENT** knob to select **“DELETE”**, then press the **[SELECT]** soft key.

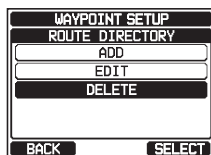

3. Rotate the **DIAL/ENT** knob to select the route to be deleted, then press the **[SELECT]** soft key.

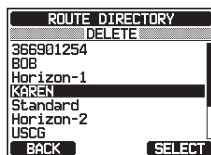

4. Confirm the route to be deleted, rotate the **DIAL/ENT** knob to select **“OK”**, then press the **[SELECT]** soft key.

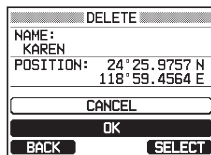

11.2.2 Starting and Stopping Route Navigation

1. **[MENU]** → **“NAVI”** → **“ROUTE”**

2. Rotate the **DIAL/ENT** knob to select the desired category (**“HISTORY”** or **“MEMORY”**), then press the **[SELECT]** soft key.

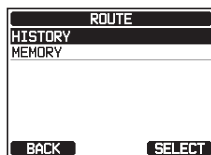

3. Rotate the **DIAL/ENT** knob to select a route, then press the **[SELECT]** soft key. The navigation screen with “RUT” indicator appears.
4. A message “ARRIVED” will appear when you have reached to the first target point.
To start navigation to the next target, press the **[YES]** soft key.
5. Press one of the soft keys to show the key selections.
Press the **[STOP]** soft key to stop the navigation.

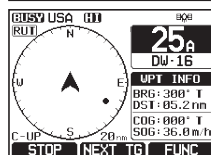
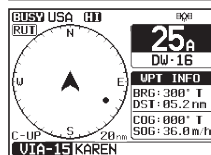
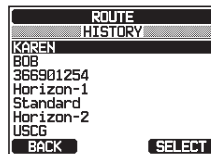

11.2.3 Changing the Destination

1. On the navigation screen, press one of the soft keys to show the key selections.
2. Press the **[NEXT TG]** soft key.
3. Rotate the **DIAL/ENT** knob to select desired destination, then press the **[SELECT]** soft key.
4. The navigation screen with a new destination appears.

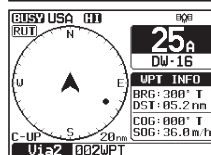
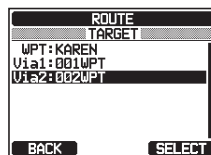
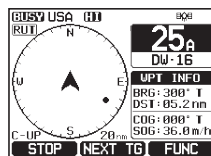

11.2.4 Selecting Automatic or Manual Routing

This selection allows you to start navigation to the next target automatically or manually when your vessel has arrived at a waypoint.

1. **[MENU]** → “SETUP” → “WAYPOINT SETUP” → “ROUTING OPERATION”
2. Rotate the **DIAL/ENT** knob to select “**AUTO**” or “**MANUAL**”, then press the **[ENTER]** soft key.
3. Press the **CLEAR** key to return to radio operation.

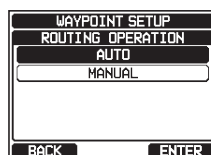

12 GM OPERATION

The GM (Group Monitor) feature of the **GX6000** utilizes the same system as the DSC Group call and Auto Position Polling, to display the group members' locations.

12.1 SETTING UP GM OPERATION

The **GX6000** is capable of storing up to 10 groups with 1 to 9 members each.

12.1.1 Setting Up GM Group Directory

NOTE

- For this function to operate, the same group MMSI must be programmed into each transceiver of group members to be monitored. Refer to section “**10.5.1 Setting up a Group Call**” for details.
- Group members for GM operation can only be selected from the Individual/Position Call directory, there for all members that you want to monitor have to be stored in the directory. Refer to section “**10.4.1 Setting up the Individual / Position Call Directory**” for details.

1. **[MENU]** → “**SETUP**” → “**GM SETUP**” → “**GM GROUP DIRECTORY**”

2. Rotate the **DIAL/ENT** knob to select “**ADD**”, then press the **[SELECT]** soft key.

GM SETUP
GM GROUP DIRECTORY
ADD
EDIT
DELETE
BACK SELECT

3. Rotate the **DIAL/ENT** knob to select “**NAME:**”, then press the **[SELECT]** soft key.

4. Enter the GM group name by rotating the **DIAL/ENT** knob and the **[SELECT]** soft key.

GM GROUP DIRECTORY
NAME:

GM ID:
0-----
MEMBERS
SAVE
BACK SELECT

When finished entering the name (using eleven characters or less), press the **[FINISH]** soft key.

5. Rotate the **DIAL/ENT** knob to select “**GM ID:**”, press the **[SELECT]** soft key, then enter the group MMSI number.

When finished entering the MMSI, press the **[FINISH]** soft key.

GM GROUP DIRECTORY
NAME:
Standard
GM ID:
0-----
MEMBERS
SAVE
BACK SELECT

6. Rotate the **DIAL/ENT** knob to select “**MEMBERS**”, then press the **[SELECT]** soft key.

GM GROUP DIRECTORY
NAME:
Standard
GM ID:
087654323
MEMBERS
SAVE
BACK SELECT

7. Rotate the **DIAL/ENT** knob to select a list number, then press the **[SELECT]** soft key.
8. Rotate the **DIAL/ENT** knob to select a member from the Individual directory, then press the **[SELECT]** soft key.
9. Repeat steps 8 to add members to the group, then press the **[BACK]** soft key.
10. Press the **[BACK]** soft key to return to the “**NAME:**” and “**GM ID:**” screen.
11. Rotate the **DIAL/ENT** knob to select “**SAVE**” to store the data, then press the **[ENTER]** soft key.
12. To enter another group directory, repeat steps 2 through 11.
13. Press the **CLEAR** key to return to radio operation.

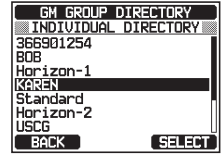

12.1.2 Setting Up the Polling Time Interval

1. **[MENU]** → “**SETUP**” → “**GM SETUP**” → “**INTERVAL**”
2. Rotate the **DIAL/ENT** knob to select the desired interval time, then press the **[ENTER]** soft key.
3. Press the **CLEAR** key to return to radio operation.

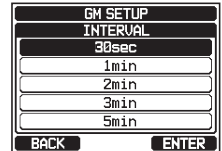

12.1.3 Enabling/Disabling Transmission during GM Operation

1. **[MENU]** → “**SETUP**” → “**GM SETUP**” → “**GM TX**”
2. Rotate the **DIAL/ENT** knob to select the desired transmission type, then press the **[ENTER]** soft key.
 - OFF: Disables the transmission during GM operation.
 - ON GM: Enables the transmission during the GM target display.
 - ON ALL: Enables the transmission during the GM operation.
3. Press the **CLEAR** key to return to radio operation.

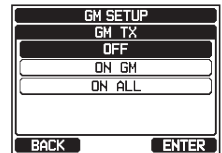

12.2 STARTING GM OPERATION

NOTE

To start GM operation, configure the GM Group Directory setting in setup menu. Otherwise, you cannot start the GM operation. Refer to section “12.1.1 Setting Up GM Group Directory” for details.

1. Press the **[MENU]** key to display the “GM” menu.
2. Rotate the **DIAL/ENT** knob to select the desired category (“**HISTORY**” or “**MEMORY**”), then press the **[SELECT]** soft key.
3. Rotate the **DIAL/ENT** knob to select a group you want to monitor, then press the **[SELECT]** soft key.

The GM operation starts and the GM target display appears.

4. Press the **CLEAR** key to return to radio operation.

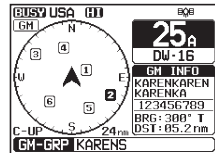
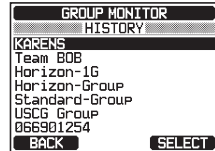
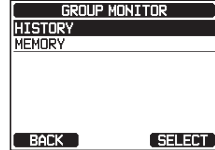

12.2.1 Changing the GM Group Being Monitored

1. On the GM target display, press one of the soft keys to show the key selections.
2. Press the **[TG LIST]** soft key.
3. Press the **[CHG GP]** soft key.
4. Rotate the **DIAL/ENT** knob to select the name of the group you want to start monitoring, then press the **[ENTER]** soft key.

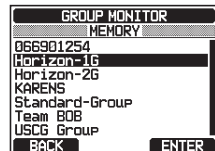
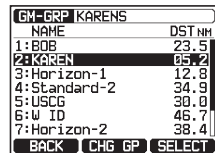
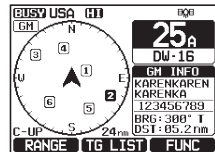

The GM group being monitored changes. The GM target display appears.

5. Press the **CLEAR** key to return to radio operation.

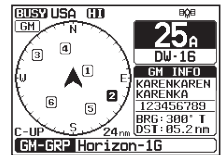

12.2.2 Transmitting a DSC Call to a Group Member

1. On the GM target display, press one of the soft keys to show the key selections.
2. Press the **[TG LIST]** soft key.
3. Rotate the **DIAL/ENT** knob to select a member you want to call.
4. Press the **[SELECT]** soft key to display the location, distance, and bearing of the selected member.
5. Press the **[CALL]** soft key to transmit a DSC Individual call to the selected member.

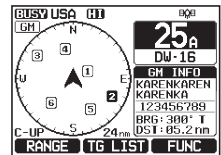

GM-GRP KARENS		DST NM
1: BOB		23.5
2: KAREN		05.2
3: Horizon-1		12.8
4: Standard-2		34.9
5: USCG		30.0
6: W ID		46.7
7: Horizon-2		38.4

GM-GRP KARENS	
POS INFO	
123456789	
KAREN	
Position:	24°25.9755 S
	118°59.4566 W
POS Time:	12:56 AM LDC
DST:	118°59.4566 W
BRG:	120° T

12.2.3 Starting Navigation to a Group Member

1. On the GM target display, press one of the soft keys to show the key selections.
2. Press the **[TG LIST]** soft key.
3. Rotate the **DIAL/ENT** knob to select a member you want to approach.
4. Press the **[SELECT]** soft key to display the location, distance, and bearing of the selected member.
5. Press the **[TO WPT]** soft key to start navigation to the selected member. (Press the **[BACK]** soft key twice to cancel and return to the GM target display.)

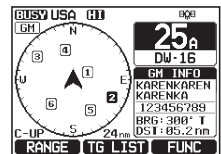

GM-GRP KARENS		DST NM
1: BOB		23.5
2: KAREN		05.2
3: Horizon-1		12.8
4: Standard-2		34.9
5: USCG		30.0
6: W ID		46.7
7: Horizon-2		38.4

GM-GRP KARENS	
POS INFO	
123456789	
KAREN	
Position:	24°25.9755 S
	118°59.4566 W
POS Time:	12:56 AM LDC
DST:	118°59.4566 W
BRG:	120° T

13 AUTOMATIC IDENTIFICATION SYSTEM (AIS)

13.1 GENERAL

NOTE

- The **GX6000** is equipped with an antenna connection designated for AIS. By connecting a marine antenna to this connector, the transceiver can receive AIS signals while receiving a VHF voice transmissions.
- Install the VHF antenna and the AIS antenna as far away from each other as possible. Having a large vertical distance is especially effective for improving high frequency isolation. To make even longer-range communication possible, it is recommended to install the antenna for VHF at a height higher than the antenna for AIS.

The Automatic Identification System (AIS) is a short range coastal tracking system. AIS is intended to assist in collision avoidance by seeing positions and courses of AIS equipped vessels around your vessel.

AIS is mandatory on passenger ships, irrespective of size, all ships 300 gross tonnage and larger engaged on international voyages, cargo ships of 500 gross tonnage and larger not engaged on international voyages.

AIS uses two marine VHF channels. Each ship equipped with an AIS transponder transmits a packet every few seconds with information about the ship and its voyage. Radio frequencies: AIS1 = 161.975 MHz and AIS2 162.025 MHz. A stand-alone AIS receiver or the AIS receiver built in to a Class A or Class B transponder can pick up these radio signals and translate them into a NMEA data sentence that can be understood by a computer with the proper software or by an AIS-enabled chart plotter.

Classes of AIS:

Class A - 12.5W power output - mandated for use on SOLAS Chapter V vessels (and others in some countries).

Class B CS - 2W output - lower cost derivative for leisure and non-SOLAS markets.

The **GX6000** is capable of receiving Class A and Class B CS transmissions with the internal Dual Channel AIS receiver.

13.2 AIS OPERATION

The **GX6000** is equipped with an AIS receiver and can display AIS targets around your vessel on the radio's display. Therefore, you can identify and avoid in proximity to your vessel.



NOTE

To show AIS targets on the radio's display, the optional **SCU-31** or an external GPS devices needs to be connected via NMEA 0183 or NMEA 2000 so the radio knows its position relative to the AIS targets.

1.  → "AIS"

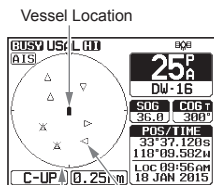
The AIS display shows your vessel as a  icon in the center of the display. AIS targets are shown as triangles. The line projected from the circle is the AIS vessels course over ground (COG).



2. Press the **▶/◀** key to change the AIS target. Pressing the **◀** key sequentially displays AIS vessels in order closest to your ship. Pressing the **▶** key sequentially displays AIS vessels in order furthest from your ship. The selected AIS target is displayed with a  icon, while other stations are displayed with a  icon.

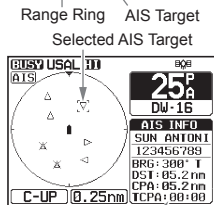

Information of the AIS Target

Note: Up to 15 AIS targets can be shown on the display. All received AIS targets are displayed on the compatible chartplotter or navigation software via NMEA 0183 or NMEA 2000.

3. Press the **CLEAR** key to return to radio operation.

13.2.1 Displaying the AIS Target Information Screen

1. On the AIS screen, press one of the soft keys to show the key selections. These selections are described below:

[RANGE]: Press this key to change the display range of the screen.

[TG LIST]: Press this key to show a list of the MMSI numbers or the vessel names being received.

[FUNC]: Press this key to show the function menu.

2. Press the **[TG LIST]** soft key to show a list of AIS target being received.

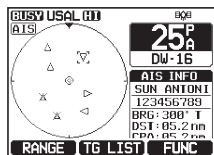

3. Rotate the **DIAL/ENT** knob to select the MMSI number (or vessel name). then press the **[SELECT]** soft key. Pressing the **[DANGER]** soft key changes the order to the TCPA time order.
4. The AIS target information screen appears. To see more information of the AIS target, press the **[NEXT]** soft key.
5. Press the **CLEAR** key to return to radio operation.

ALL TARGET LIST			
NAME/MMSI	BRG	T	DST/NM
BOB	118.5	23.5	
KAREN	338.0	05.2	
Horizon-1	---	---	12.8
Standard-2	---	---	34.9
USCG	---	---	30.0
W ID	---	---	46.7
Horizon-2	---	---	38.4

BACK DANGER SELECT

TARGET INFO 1/5	
Class:	CLASS A
MMSI:	366901254
Name:	BOB
Origin:	
Call Sign:	
IMD No:	

BACK CALL NEXT

13.2.2 Changing the AIS Range

1. On the AIS screen, press one of the soft keys to show the key selections.
2. Press the **[RANGE]** soft key. Press the soft keys at the center and right side to select the radius range to display on the AIS screen.
3. Press the **[BACK]** soft key to return to AIS screen.

AIS		RNG	
USAL (A)		25P	
		DW-16	
AIS INFO			
SUN ANTONI			
123456789			
BRG: 300° T			
DST: 85.2 nm			
CPA: 85.2 nm			

RANGE TG LIST FUNC

AIS		RNG	
USAL (A)		25P	
		DW-16	
AIS INFO			
SUN ANTONI			
123456789			
BRG: 300° T			
DST: 85.2 nm			
CPA: 85.2 nm			

BACK 12nm 48nm

NOTE

You may change the display range unit of the AIS screen, refer to section “18.7 UNITS OF MEASURE”.

13.2.3 Transmitting an Individual Call to an AIS Ship

It is possible for the **GX6000** to transmit a DSC individual call to a received AIS target by the procedure below:

1. On the AIS screen, press one of the soft keys to show the key selections.
2. Press the **[TG LIST]** soft key to show a list of AIS target being received.
3. Rotate the **DIAL/ENT** knob to select the MMSI number (or vessel name). then press the **[SELECT]** soft key.

AIS		RNG	
USAL (A)		25P	
		DW-16	
AIS INFO			
SUN ANTONI			
123456789			
BRG: 300° T			
DST: 85.2 nm			
CPA: 85.2 nm			

RANGE TG LIST FUNC

ALL TARGET LIST			
NAME/MMSI	BRG	T	DST/NM
BOB	118.5	23.5	
KAREN	338.0	05.2	
Horizon-1	---	---	12.8
Standard-2	---	---	34.9
USCG	---	---	30.0
W ID	---	---	46.7
Horizon-2	---	---	38.4

BACK DANGER SELECT

4. Press the **[CALL]** soft key

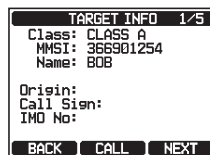

5. In the INTERSHIP CH list, rotate the **DIAL/ENT** knob to select the operating channel on which you want to communicate, then press the **[SELECT]** soft key. To select operating channels from all voice channels, press the **[MANUAL]** soft key.

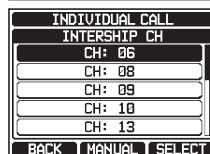

6. To transmit an individual DSC call to the select AIS ship, press the **[YES]** soft key.

After the **GX6000** transmits, the radio waits for the DSC radio on the AIS ship to transmit a reply, at which time the radio will ring like a telephone. Pick up the mic, press the **PTT** switch and talk to the AIS vessel.



7. Press the **[QUIT]** soft key to return to AIS screen.

8. Press the **CLEAR** key to return to radio operation.



13.2.4 CPA/TCPA Alarm Functions

The CPA (Closest Point of Approach) alarm sounds when other AIS vessels enter within the range set as the CPA Limit. For details, refer to section “**13.3.1 CPA**”.

The TCPA (Time to Closest Point of Approach) alarm sounds according to the time set as the TCPA Limit which is the time taken until other AIS vessels enter within the range set as the CPA Limit. For details, refer to section “**13.3.2 TCPA**”.

1. If other AIS vessels approach your ship, the alarm sounds according to the CPA Limit and TCPA Limit that you set in advance.
2. Press any key to stop the alarm.

The targets for the CPA/TCPA alarm will appear with “**[X]**” and flash.

Up to 15 targets for the CPA/TCPA alarm can be shown on the screen.

Note: If the display is in a mode other than AIS, the radio automatically switches to the AIS mode.

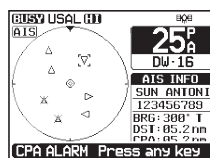

- On the display you will notice 3 soft key selections.

These selections are described below:

[INFO]: Pressing this key shows the information screen of the CPA/TCPA alarm targets.

[CALL]: Pressing this key switches the screen to the setting screen for transmitting individual DSC calls.

[QUIT]: Press this key to return to AIS screen.

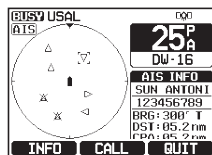

- To transmit individual calls to the CPA/TCPA alarm targets, follow steps 4 through 8 in “**13.2.3 Transmitting an Individual Call to an AIS Ship**”

13.2.5 Changing the Compass Display

The compass display can be switched between “COURSE-UP” and “NORTH-UP”. The default setting is “COURSE-UP”.

Refer to section “**18.2 COMPASS DIRECTION**” for details.

13.3 AIS SETUP



13.3.1 CPA

This function allows you to set the CPA (Closest Point of Approach)* alarm distance.

※: CPA means the positions at which two moving vessels reach their closest possible distance.



- Rotate the **DIAL/ENT** knob to select the distance you want the radio to alert you of an approaching AIS equipped vessel. You can select one from “**0.5nm**”, “**1nm**”, “**2nm**”, “**5nm**”, or “**10nm**” (“0.5nm” is default).
- Press the **[ENTER]** soft key to store the selected setting.
- Press the **CLEAR** key to return to radio operation.

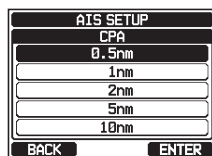

13.3.2 TCPA

This function allows you to set the TCPA (Time to Closest Point of Approach)* alarm.

※: Setting up a TCPA alarm sets a time point where the radio will alarm when an AIS equipped vessel approaching is within the time selected.

1.  → "SETUP" → "AIS SETUP" → "TCPA"

2. Rotate the DIAL/ENT knob to select the time you want the radio to alert you of an approaching AIS equipped vessel. The time can be set from "1min" to "30min" ("10min" is default).
3. Press the **[ENTER]** soft key to store the selected setting.
4. Press the **CLEAR** key to return to radio operation.

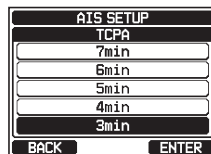

13.3.3 CPA/TCPA Alarm

Enable/disable the CPA/TCPA alarm functions. The default setting is "OFF".

1.  → "SETUP" → "AIS SETUP" → "CPA/TCPA ALARM"

2. Rotate the **DIAL/ENT** knob to select "CPA" or "TCPA", then press the **[SELECT]** soft key.

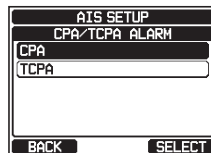

3. Rotate the **DIAL/ENT** knob to select "OFF" or "ON".
4. Press the **[ENTER]** soft key to store the selected setting.
5. Press the **CLEAR** key to return to radio operation.

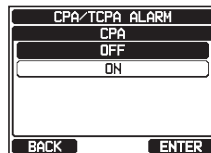

NOTE

The alarm will sound until it is disabled (1) by pressing any key, (2) following the steps above and selecting "OFF" in step 3, or (3) when the ship is out of the selected CPA/TCPA alarm range. The alarm is produced from the front panel speaker, the speaker in the mic, the optional external speaker and optional **RAM4** and **RAM4W** mic when connected.

14 NMEA 2000 SETUP

Set the device numbers and system numbers of devices connected to the NMEA 2000 network.

14.1 SELECT DEVICE

Select the device for which you want to set the device number and system number.

1. 

2. In the SELECT DEVICE list, rotate the **DIAL/ENT** knob to select the external device for which you want to set the device number or the system number.

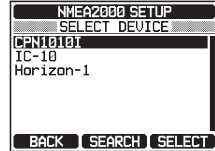

3. Press the **[SELECT]** soft key to store the selected setting.
4. Press the **CLEAR** key to return to radio operation.

NOTE

If any devices connected to the network are not displayed in the list, press the **[SEARCH]** soft key to update the list.

14.2 DEVICE NUMBER

If connecting two or more GX6000 radios, change the device number of either one. Set the device number of the device selected in “14.1 SELECT DEVICE”.

1. 

2. Rotate the **DIAL/ENT** knob to select the first digit of the device number, then press the **[SELECT]** soft key to step to the next number.
3. Repeat step 2 to set the device number within the range of 000 to 251. (“000” is default).
4. If a mistake was made entering in the device number, rotate the **DIAL/ENT** knob to select “←” or “→”, press the **[SELECT]** soft key until the wrong character is selected, then perform step 2.
5. When finished programming the device number, press the **[FINISH]** soft key.

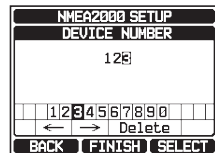
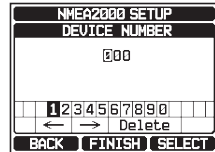

6. Press the **CLEAR** key to return to radio operation.

14.3 SYSTEM NUMBER

Set the system number of the device selected in “14.1 SELECT DEVICE”.

1.  → “SETUP” → “NMEA2000 SETUP” → “SYSTEM NUMBER”

2. Rotate the **DIAL/ENT** knob to select the first digit of the system number, then press the **[SELECT]** soft key to step to the next number.

3. Repeat step 2 to set the system number within the range of 00 to 15. (“00” is default).

4. If a mistake was made entering in the system number, rotate the **DIAL/ENT** knob to select “←” or “→”, press the **[SELECT]** soft key until the wrong character is selected, then perform step 2.

5. When finished programming the system number, press the **[FINISH]** soft key.

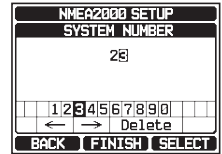
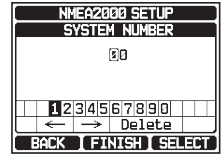

6. Press the **CLEAR** key to return to radio operation.

14.4 SUMMARY OF THE NMEA 2000 SETUP

Item	Description	Default Value	Page
SELECT DEVICE	Select the device for which you want to set the device number or the system number	-	102
DEVICE NUMBER	Set the device number	000	102
SYSTEM NUMBER	Set the system number	00	103

14.5 COMPATIBLE NMEA 2000 PGN LIST

Receive		Transmit	
059392	ISO Acknowledgement	059392	ISO Acknowledgement
059904	ISO Request	059904	ISO Request
060928	ISO Address Claim	060928	ISO Address Claim
065240	ISO Commanded Address	-	-
126464	Receive/Transmit PGN's group function	126464	Receive/Transmit PGN's group function
126993	Heartbeat	126993	Heartbeat
126996	Product Information	126996	Product Information
127237	Heading/Track Control	-	-
127250	Vessel Heading	-	-
127258	Magnetic Variation	-	-
128259	Speed	-	-
129025	Position, Rapid Update	-	-
129026	COG and SOG, Rapid Update	-	-

Receive		Transmit	
129029	GNSS Position Data	129029	GNSS Position Data
129033	Local Time Offset	-	-
-	-	129038	AIS Class A Position Report
-	-	129039	AIS Class B Position Report
-	-	129040	AIS Class B Extended Position Report
-	-	129041	AIS Aids to Navigation (AtoN) Report
-	-	129793	AIS UTC and Date Report (Base Station)
-	-	129794	AIS Class A Static and Voyage Related Data
-	-	129796	AIS Acknowledge
-	-	129797	AIS Binary Broadcast Message
-	-	129798	AIS SAR Aircraft Position Report
-	-	129799	Radio Frequency/Mode/Power
-	-	129801	AIS Addressed Safety Related Message
-	-	129802	AIS Safety Related Broadcast Message
-	-	129808	DSC Call Information
-	-	129809	AIS Class B "CS" Static Data Report, Part A
-	-	129810	AIS Class B "CS" Static Data Report, Part B
129540	GNSS Sats in View	129540	GNSS Sats in View

15 CONFIGURATION SETUP

15.1 DISPLAY MODE

The display mode can be selected according to the time of day you operate the radio.

1.  → "SETUP" → "CONFIGURATION" → "DISPLAY MODE"

2. Rotate the **DIAL/ENT** knob to select the desired setting. You can select one from "DAY MODE" or "NIGHT MODE".

DAY MODE: Normal display mode.

NIGHT MODE: Low brightness display mode for night use.

3. Press the **[ENTER]** soft key to store the selected setting.
4. Press the **CLEAR** key to return to radio operation.

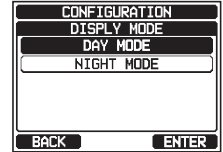

15.2 DIMMER ADJUSTMENT

This menu selection adjusts the backlight intensity.

1.  → "SETUP" → "CONFIGURATION" → "DIMMER"

2. Rotate the **DIAL/ENT** knob to select the desired level ("7" is default). When "OFF" is selected, the lamp is turned off.
3. Press the **[ENTER]** soft key to store the selected level.
4. Press the **CLEAR** key to return to radio operation.

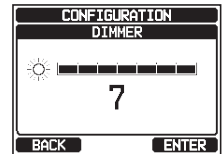

15.3 DISPLAY CONTRAST

The display contrast can be adjusted to suit your operation environment.

1.  → "SETUP" → "CONFIGURATION" → "CONTRAST"

2. Rotate the **DIAL/ENT** knob to select the desired level. The contrast level can be set from "1" to "30" ("15" is default).
3. Press the **[ENTER]** soft key to store the selected level.
4. Press the **CLEAR** key to return to radio operation.

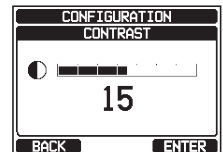

15.4 KEY BEEP

This selection is used to select the beep tone volume level when a key is pressed.

1. [MENU] → "SETUP" → "CONFIGURATION" → "KEY BEEP"

2. Rotate the **DIAL/ENT** knob to select the desired level. The beep level can be set from "1" to "7", or "OFF" ("4" is default).
3. Press the [ENTER] soft key to store the selected level.
4. Press the **CLEAR** key to return to radio operation.

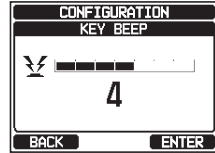

15.5 FOG ALERT TONE FREQUENCY

The function allows the radio to be setup to send the proper fog frequency which is dependent on vessel size, shown below:

- 70 - 200Hz: Vessel that are 660 feet (200 meters) or more in length
- 130 - 350Hz: Vessel that are 247.5 feet (75 meters) or more but less than 660 feet (200 meters) in length
- 250 - 700Hz: Vessel that are 66 feet (20 meters) or more but less than 247.5 feet (75 meters) in length
- 250 - 700Hz: Vessel that are 39.6 feet (12 meters) or more but less than 66 feet (20 meters) in length

1. [MENU] → "SETUP" → "CONFIGURATION" → "FOG FREQUENCY"

2. Rotate the **DIAL/ENT** knob to select the desired level. The frequency level can be set from "200Hz" to "850Hz" ("400Hz" is default).
3. Press the [ENTER] soft key to store the selected setting.
4. Press the **CLEAR** key to return to radio operation.

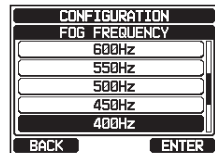

NOTE

By default, the radio Fog frequency is set to 400 Hz. In most cases this frequency should not be changed unless the vessel is very large.

15.6 LISTEN BACK

While in PA, FOG HORN, or HORN mode, toggle the listen back function between ON and OFF.

1. [MENU] → "SETUP" → "CONFIGURATION" → "LISTEN BACK"

2. Rotate the **DIAL/ENT** knob to select “OFF” or “ON” (“ON” is default).
3. Press the **[ENTER]** soft key to store the selected setting.
4. Press the **CLEAR** key to return to radio operation.

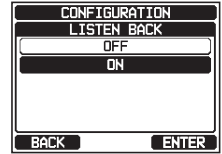

15.7 STATION NAME

This function allows you to change the name of the radio or second station microphone.

Example: “RADIO - CABIN”, “RAM 1 - FLYBRIDGE”

1. **[MENU]** → “SETUP” → “CONFIGURATION” → “STATION NAME”

2. With the second station microphone connected, rotate the **DIAL/ENT** knob to select the unit to be named, then press the **[SELECT]** soft key.
3. Rotate the **DIAL/ENT** knob to select to scroll through the first letter of the new station name.
4. Press the **[SELECT]** soft key to store the first letter in the name and step to the next letter to the right.
5. Repeat steps 3 and 4 until the name is complete. The name can consist of up to ten characters, and if you do not use all ten characters, select “→” to move to the next space. This method can also be used to enter a blank space in the name.

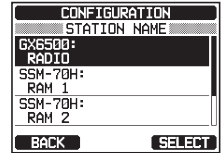

If a mistake was made entering in the station name, rotate the **DIAL/ENT** knob to select “←” or “→”, press the **[SELECT]** soft key until the wrong character is selected, then perform steps 3 and 4.

6. When finished entering the station name (using ten characters or less), press the **[FINISH]** soft key to advance to the second station name entry.
7. Rotate the **DIAL/ENT** knob to select “SSM-70H”, then press the **[SELECT]** soft key.
8. Rotate the **DIAL/ENT** knob to select to scroll through the first letter of the new station name.

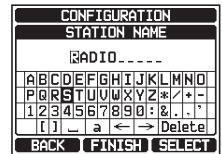

9. Press the **[SELECT]** soft key to store the first letter in the name and step to the next letter to the right.

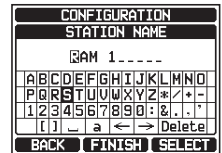
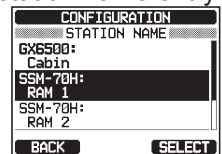

10. Repeat steps 8 and 9 until the name is complete. The name can consist of up to ten characters, and if you do not use all ten characters, select “→” to move to the next space. This method can also be used to enter a blank space in the name.

If a mistake was made entering in the station name, rotate the **DIAL/ENT** knob to select “←” or “→”, press the **[SELECT]** soft key until the wrong character is selected, then perform steps 8 and 9.

11. When finished entering the station name (using ten characters or less), press the **[FINISH]** soft key.

12. Press the **CLEAR** key to return to radio operation.

15.8 SOFT KEYS

From this menu, you can assign desired functions to each soft key from numbers 01 to 12. You can also set how long the soft key icon will be displayed after the corresponding soft key is pressed.

15.8.1 Key Assignment

1. **[MENU]** → “**SETUP**” → “**CONFIGURATION**” → “**SOFT KEY**”

2. Rotate the **DIAL/ENT** knob to select “**KEY ASSIGNMENT**”, then press the **[SELECT]** soft key.

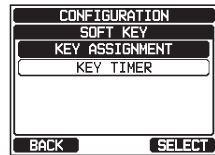

3. Rotate the **DIAL/ENT** knob to select the key number to be programmed, and press the **[SELECT]** soft key.

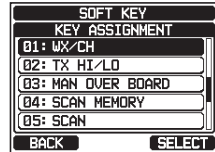

4. Rotate the **DIAL/ENT** knob to select a new function to be assigned, and press the **[ENTER]** soft key. Available functions are listed below. By selecting “**NONE**” the soft key assignment is removed.

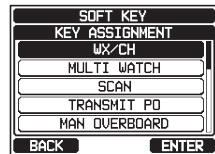

5. Repeat steps 3 and 4 to program other soft keys.

The VHF radio's functions can be assigned to the maximum of 12 soft keys. Pressing the **▶/◀** key each time shows three different soft keys.



6. Press the **CLEAR** key to return to radio operation.

DISPLAY	FUNCTION	SOFT KEY NUMBERS ASSIGNED AS DEFAULT (See the previous page.)
NONE	-	
TX HI/LO	Selects transmit power	02
WX/CH	Switches channels between weather and marine	01
SCAN	Turns on or off scanning function	05
DUAL WATCH / TRIPLE WATCH	Starts and stops dual watch scan	06
MARK POSITION	Marks the current position for a "Waypoint"	09
SCAN MEMORY	Add or remove channels from memory channel scan	04
PRESET	Programs or deletes the preset memory channel	10
MAN OVERBOARD	Marks the position where a person falls overboard	03
NOISE CANCEL	Enables the noise canceling settings display	
CH NAME	Edit channel names	
SCRAMBLER	Configures the secret communication settings	
COMPASS	Enables the "Compass" display	
NAVIGATION	Enables the "Waypoint" or "Route" navigation display	
FOG HORN	Select FOG HORN mode	
INTERCOM	Activates intercom between radio and RAM4 mic (optional SSM-70H (RAM4) or SSM-71H (RAM4W) required)	
GPS LOGGER	Starts and stops logging position data	
AIS DISPLAY	Shows the "AIS" display	
HORN BUTTON	Activates the Fog Horn function	12
PUBLIC ADDRESS	Activates the PA function	
RX RECORD	Records received voices	07
RX SENSE	Toggles between LOCAL and DISTANCE	11
PLAY	Plays recorded voices	08

15.8.2 Key Timer

1.  → "SETUP" → "CONFIGURATION" → "KEY TIMER"

2. Rotate the **DIAL/ENT** knob to select "KEY TIMER", then press the **[SELECT]** soft key.

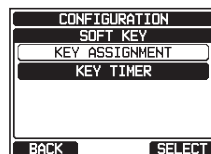

3. Rotate the **DIAL/ENT** knob to select the desired time.

4. Press the **[ENTER]** soft key to store the selected setting.

5. Press the **CLEAR** key to return to radio operation.

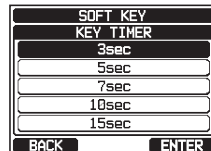

15.9 RESET

You may reset the memory and settings of the setup categories independently or return the transceiver to the original factory setting.

1.  → "SETUP" → "CONFIGURATION" → "RESET"

2. Rotate the **DIAL/ENT** knob to select the desired category. You can select one from "**DSC/GM SETUP**", "**WAYPOINT SETUP**", "**CHANNEL SETUP**", "**GPS SETUP**", "**AIS SETUP**", "**CONFIGURATION**", or "**FACTORY**" (all settings* except the "**MMSI**" and "**Vessel Information**" will be initialized).

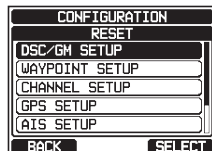

(*: The Individual Directory and the GPS Log also eliminated.)

3. Press the **[SELECT]** soft key.
4. Press the **[YES]** soft key. (To cancel, press the **[NO]** soft key.)

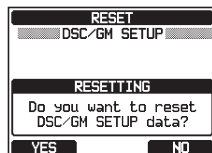

5. Press the **[OK]** soft key.
6. Press the **CLEAR** key to return to radio operation.

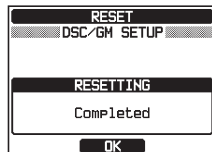

15.10 SUMMARY OF THE CONFIGURATION SETUP

Item	Description	Default Value	Page
DISPLAY MODE	Toggles LCD display mode between daytime and nighttime mode	DAY MODE	105
DIMMER	Adjusts the backlight level of the LCD and keypad	DAY MODE: 7 NIGHT MODE: 4	105
CONTRAST	Adjusts the contrast of the LCD	15	105
KEY BEEP	Adjusts the volume of beep tone when a key is pressed	4	106
FOG FREQUENCY	Sets the tone frequency when transmitting FOG	400Hz	106
LISTEN BACK	Turns on or off of listen back function	ON	106
STATION NAME	Sets the names of the radio and external devices	RADIO RAM 1 RAM 2	107
SOFT KEY	Sets the assignment and display time of the soft keys	10 sec	108
RESET	Initializes the memories and settings	-	110

16 CHANNEL FUNCTION SETUP

16.1 CHANNEL GROUP

This menu item allows you to select a channel group from USA, Canada, and International.

Refer to section “8.7 USA, INTERNATIONAL, AND CANADA MODE” for details.

16.2 WEATHER ALERT

Enables/disables the NOAA Weather Alert function. The default setting is “ON”.

1.  → “SETUP” → “CHANNEL SETUP” → “WEATHER ALERT”

2. Rotate the **DIAL/ENT** knob to select “ON” or “OFF”.
3. Press the **[ENTER]** soft key to store the selected setting.
4. Press the **CLEAR** key to return to radio operation.

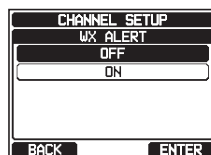

16.3 SCAN MEMORY

To be able to scan channels the radio must be programmed. This section allows channels to be stored in scan memory.

Refer to section “8.10.2 Programming Scan Memory” for details.

16.4 SCAN TYPE

This selection is used to select the scan mode between “MEMORY” and “PRIORITY”. The default setting is “PRIORITY”.

Refer to section “8.10.1 Selecting the Scan Type” for details.

16.5 SCAN RESUME

This selection is used to select the time the **GX6000** waits after the received signal ends before the radio starts to scan channels again. The default setting is 2 seconds.

1.  → “SETUP” → “CHANNEL SETUP” → “SCAN RESUME”

2. Rotate the **DIAL/ENT** knob to select the desired resume time, default is 2 seconds. The resume time can be set to “1sec” through “5sec”.
3. Press the **[ENTER]** soft key to store the new setting.
4. Press the **CLEAR** key to return to radio operation.

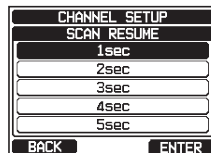

16.6 MULTI WATCH

This selection is used to select the watch type between “DUAL” and “TRIPLE”. The default setting is “DUAL”.

Refer to section “8.9 MULTI WATCH (TO PRIORITY CHANNEL)” for details.

16.7 PRIORITY CHANNEL

This procedure allows the radio to use a different priority channel used when priority scanning. By default, the radio priority channel is set to Channel 16.

1.  → “**SETUP**” → “**CHANNEL SETUP**” → “**PRIORITY CHANNEL**”

2. Rotate the **DIAL/ENT** knob to select the desired channel to be a priority.
3. Press the **[ENTER]** soft key to store the new setting.
4. Press the **CLEAR** key to return to radio operation.

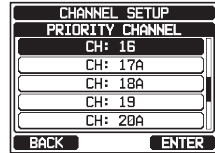

16.8 SUB CHANNEL

By default, the sub channel is set to Channel 9. This procedure allows the radio to assign a different sub channel for instant access.

1.  → “**SETUP**” → “**CHANNEL SETUP**” → “**SUB CHANNEL**”

2. Rotate the **DIAL/ENT** knob to select the desired channel to be a sub channel.
3. Press the **[ENTER]** soft key to store the new setting.
4. Press the **CLEAR** key to return to radio operation.

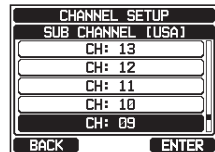

16.9 CHANNEL NAME

When the radio (“Normal”) mode is selected, the display will show a name under the channel number. This name describes the use of the channel. The radio has the capability to customize the name by the procedure below.

Example: CH69 PLEASURE to HOOKUP

1.  → “**SETUP**” → “**CHANNEL SETUP**” → “**CHANNEL NAME**”

2. Rotate the **DIAL/ENT** knob to select the channel to be named, then press the **[SELECT]** soft key.
3. Rotate the **DIAL/ENT** knob to scroll through the first letter of the new channel name.

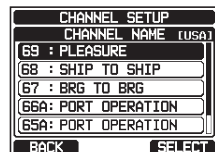

4. Press the **[SELECT]** soft key to store the first letter in the name and step to the next letter to the right.
5. Repeat step 3 and 4 until the name is complete. The name can consist of up to 16 characters, if you do not use all 16 characters, select “→” to move to the next space. This method can also be used to enter a blank space in the name.



If a mistake was made entering in the channel name, rotate the **DIAL/ENT** knob to select “←” or “→”, press the **[SELECT]** soft key until the wrong character is selected, then perform steps 3 and 4.

6. When finished entering the channel name (using fifteen characters or less), press the **[FINISH]** soft key to save the name.
7. If you want to enter the name of another channel, repeat the steps 2 through 6.
8. Press the **CLEAR** key to return to radio operation.

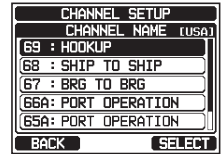

NOTE

When “CHANNEL NAME” is assigned to the soft key, you can show the channel name input display directly by pressing the **[NAME]** soft key during radio operation.

16.10 NOISE CANCELLATION

Enables/disables the Noise-canceling function of the transmitter and receiver independently.

1. **[MENU]** → “**SETUP**” → “**CHANNEL SETUP**” → “**NOISE CANCEL**”

2. Rotate the **DIAL/ENT** knob to select “**TX MODE**”, then press the **[SELECT]** soft key.

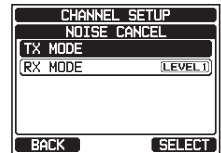

3. Rotate the **DIAL/ENT** knob to select “**ON**” or “**OFF**”, then press the **[ENTER]** soft key.

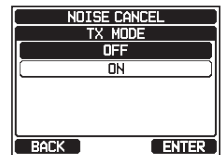

4. Rotate the **DIAL/ENT** knob to select “**RX MODE**”, then press the **[SELECT]** soft key.
5. Rotate the **DIAL/ENT** knob to select the noise level from “**LEVEL1**” through “**LEVEL4**” or “**OFF**”, then press the **[ENTER]** soft key.
6. Press the **CLEAR** key to return to radio operation.

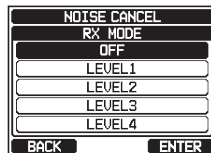

16.11 AUDIO FILTER OPERATION

This menu item allows you to select operation of the internal audio filter for the best acoustics in noisy environments. The default setting is “**NORMAL**”.

1. **[MENU]** → “**SETUP**” → “**CHANNEL SETUP**” → “**AF PITCH CONTROL**”

2. Rotate the **DIAL/ENT** knob to select the desired filter operation.
3. Press the **[ENTER]** soft key to store the new setting.
4. Press the **CLEAR** key to return to radio operation.

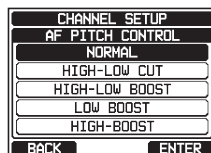

16.12 RX RECORDER

Configure settings of the function for recording received voices.

16.12.1 RX Recorder Function ON/OFF

Enable/disable the RX Recorder function. The default setting is “**OFF**”.

1. **[MENU]** → “**SETUP**” → “**CHANNEL SETUP**” → “**RX RECORDER**”

2. Rotate the **DIAL/ENT** knob to select “**ACTIVATION**”, then press the **[SELECT]** soft key.

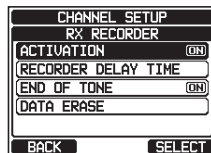

3. Rotate the **DIAL/ENT** knob to select “**ON**” or “**OFF**”, then press the **[ENTER]** soft key to store the new setting.
4. Press the **CLEAR** key to return to radio operation.

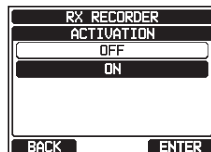

16.12.2 Setting for Recording Delay Time

Set the time interval until recording stops after the end of voice reception. The default setting is 3 seconds.

1. **[MENU]** → “**SETUP**” → “**CHANNEL SETUP**” → “**RX RECORDER**”

2. Rotate the **DIAL/ENT** knob to select “**RECORDING DELAY TIME**”, then press the **[SELECT]** soft key.
3. Rotate the **DIAL/ENT** knob to select the desired delay time. The delay time can be set to “**1sec**” through “**5sec**”.
4. Press the **[ENTER]** soft key to store the new setting.
5. Press the **CLEAR** key to return to radio operation.

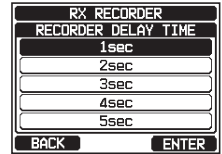
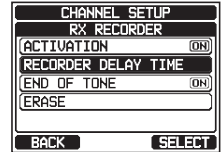

16.12.3 Setting for End of Tone

Enable/disable the tone function that indicates the end of recording when recording stops. The default setting is “ON”.

1. **[MENU]** → “**SETUP**” → “**CHANNEL SETUP**” → “**RX RECORDER**”
2. Rotate the **DIAL/ENT** knob to select “**END OF TONE**”, then press the **[SELECT]** soft key.
3. Rotate the **DIAL/ENT** knob to select “**OFF**” or “**ON**”, then press the **[ENTER]** soft key to store the new setting.
4. Press the **CLEAR** key to return to radio operation.

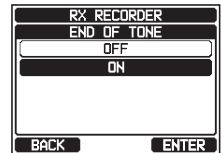
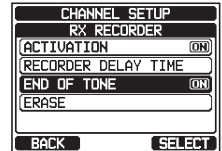

16.12.4 Data Erase

Delete recorded voice data.

1. **[MENU]** → “**SETUP**” → “**CHANNEL SETUP**” → “**RX RECORDER**”
2. Rotate the **DIAL/ENT** knob to select “**DATA ERASE**”, then press the **[SELECT]** soft key.

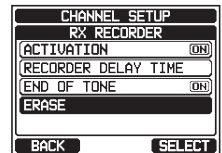

- Press the **[YES]** soft key. (To cancel, press the **[NO]** soft key.)
- Press the **[OK]** soft key.
- Press the **CLEAR** key to return to radio operation.

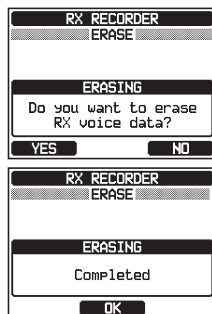

16.13 SCRAMBLER SETUP

Configure the voice scrambler setting. Two types of voice scrambler functions are available: the 4-code type (**CVS2500A** compatible) and the 32-code type (**FVP-42** compatible for Furuno Electric FM-4721) (This function is not available for CH16 and CH70).

- [MENU]** → “**SETUP**” → “**CHANNEL SETUP**” → “**SCRAMBLER**”

- Rotate the **DIAL/ENT** knob to select “**TYPE**”, then press the **[SELECT]** soft key.

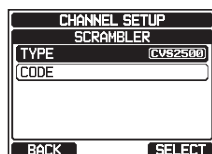

- Rotate the **DIAL/ENT** knob to select “**CVS2500**” or “**FVP-42**”, then press the **[ENTER]** soft key.

Note: Changing this setting will delete all scrambler codes set for each channel.

- Rotate the **DIAL/ENT** knob to select “**CODE**”, then press the **[SELECT]** soft key.

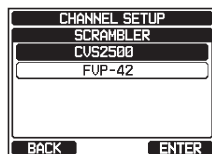

- Rotate the **DIAL/ENT** knob to select the channel to be scrambled, then press the **[SELECT]** soft key.

Note: CH16 and CH70 cannot be used.

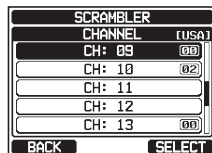
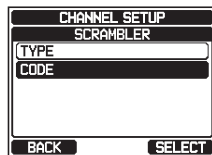

6. Rotate the **DIAL/ENT** knob to select the scrambler code. The scrambler code can be set from “00” to “03” or “OFF” (While FVP-42 is selected in step 6, the scrambler code can be set from “00” to “31” or “OFF”). When “OFF” is selected the voice scrambler is disabled.
7. Press the **[ENTER]** soft key to store the selected code.
8. Repeat steps 5 through 7 to set other channels.
9. Press the **CLEAR** key to return to radio operation.

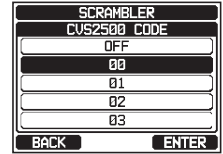

16.14 SUMMARY OF THE CANNEL FUNCTION SETUP

Item	Description	Default Value	Page
CHANNEL GROUP	Selects the channel group	USA: USA	35
WEATHER ALERT	Turns on or off the Weather Alert function	OFF	111
SCAN MEMORY	Add or remove a channel to Scan Memory	-	38
SCAN TYPE	Select priority scan or memory scan	PRIORITY	38
SCAN RESUME	Sets the resume time of scanning	2sec	111
MULTI WATCH	Selects Dual Watch or Triple Watch	DUAL	37
PRIORITY CHANNEL	Selects a priority channel	CH16	112
SUB CHANNEL	Selects a Sub Channel	CH09	112
CHANNEL NAME	Edit the name of memory channels	-	112
NOISE CANCEL	Turns on or off of noise cancelling function (independently available for transmission and reception)	OFF	113
AF PITCH CONTROL	Selects the audio filter operation	NORMAL	114
RX RECORDER	Configures settings of the function for recording received voices	ACTIVATION: OFF RECORDING DELAY TIME: 3sec END OF TONE: ON DATA ERASE: -	114
SCRAMBLER	Configures the secret communication settings	TYPE: CVS2500 CORD: -	116

17 DSC SETUP

17.1 INDIVIDUAL DIRECTORY

The **GX6000** has a DSC directory that allows you to store a vessel or person's name and the associated MMSI you wish to contact via individual calls, position requests and position report transmissions.

To transmit an individual call you program this directory with information of the vessel you wish to contact, similar to a cellular phone's telephone directory.

Refer to section "**10.4.1 Setting up the Individual / Position Call Directory**" for details.

17.2 INDIVIDUAL REPLY

This menu item sets up the radio to automatically (default setting) or manually respond to a DSC Individual call requesting you to switch to a working channel for voice communications. When "MANUAL" is selected the MMSI of the calling vessel is shown allowing you to see who is calling. This function is similar to caller id on a cellular phone.

Refer to section "**10.4.2 Setting up the Individual Call Reply**" for details.

17.3 INDIVIDUAL ACKNOWLEDGMENT

The radio can be setup to transmit a reply automatically (default) or set so the radio will not reply to an individual call.

Refer to section "**10.4.3 Enabling the Individual Call Acknowledgment**" for details.

17.4 INDIVIDUAL RINGER

The radio can be setup to ring like a telephone to alert you the radio received a DSC individual call. The default setting is 2 minutes, however this can be changed to 5, 10 or 15 seconds with the procedure below.

Refer to section "**10.4.6 Setting up the Individual Call Ringer**" for details.

17.5 GROUP DIRECTORY

For this function to operate, the same group MMSI must be programmed into all the DSC VHF radios within the group of vessels that will be using this feature.

Refer to section "**10.5.1 Setting up a Group Call**" for details.

17.6 POSITION REPLY

The **GX6000** can be set up to automatically (default setting) or manually send your position when requested by another vessel. This selection is important if you are concerned about someone polling the position of your vessel that you may not want to. In the manual mode you will see the MMSI (Maritime Mobile Service Identity Number) or persons name shown on the display allowing you to choose to send your position to the requesting vessel.

Refer to section “**10.6.1 Setting up a Position Request Reply**” for details.

17.7 AUTO POSITION POLLING

The **GX6000** has the capability to automatically track seven vessels programmed into the individual directory.

Refer to section “**10.9 AUTO POSITION POLLING**” for details.

17.8 AUTO POSITION INTERVAL

The **GX6000** has the capability to automatically track seven vessels programmed into the individual directory.

Selecting the auto position polling time interval between position request transmissions to be setup.

Refer to section “**10.9.2 Setting up the Polling Time Interval**” for details.

17.9 AUTO CHANNEL CHANGE

When a DSC distress or an all ships (urgency or safety) call is received, the **GX6000** will automatically switch to Channel 16.

This menu selection allows the automatic switch time to be changed. The default selection is 30 seconds.

1.  → “**SETUP**” → “**DSC SETUP**” → “**AUTO CHANNEL CHANGE**”

2. Rotate the **DIAL/ENT** knob to select the desired time, then press the **[ENTER]** soft key.

3. Press the **CLEAR** key to return to radio operation.

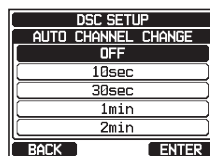

When the “**OFF**” is selected, “[**C**]” icon will light up on the screen.



17.10 NO ACTION TIMER

If no key is pressed during the “MENU” or “DSC CALL” screen, the **GX6000** will automatically return to radio operation.

The default selection is 15 minutes.

1.  → “**SETUP**” → “**DSC SETUP**” → “**NO ACTION TIMER**”

2. Rotate the **DIAL/ENT** knob to select the desired time, then press the **[ENTER]** soft key.
3. Press the **CLEAR** key to return to radio operation.

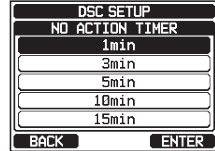

17.11 WAIT TIME FOR POSITION FIX

This menu allows you to select the maximum wait time till obtaining position information when receiving a distress call, POS Report call, or acknowledgement to POS request call.

The default selection is 15 seconds.

1.  → “**SETUP**” → “**DSC SETUP**” → “**POS UNFIX WAITING TIME**”

2. Rotate the **DIAL/ENT** knob to select the desired time, then press the **[ENTER]** soft key.
3. Press the **CLEAR** key to return to radio operation.

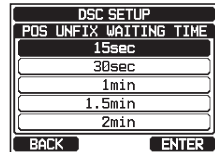

17.12 DSC BEEP

This feature allows the alarm beeps to be turned on or off when a DSC call is received. The DSC calls that can be customized are: individual, group, all ships, position request, position report, geographical, polling, and DSC test.

Refer to section “**10.5.4 Setting up the Group Call Ringer**” for details.

17.13 SUMMARY OF THE DSC SETUP MENU

Item	Description	Default Value	Page
INDIVIDUAL DIRECTORY	Enter or edit addresses used for individual call	-	56
INDIVIDUAL REPLY	Selects a reply to individual call	MANUAL	57
INDIVIDUAL ACK.	Selects the message to be sent automatically as an individual call acknowledgement	ABLE	57
INDIVIDUAL RING	Selects the ringing time when an individual call or a position request is received	2 min	61

Item	Description	Default Value	Page
GROUP DIRECTORY	Enter or edit addresses used for group call	-	62
POSITION REPLY	Selects reply mode when receiving a position call	AUTO	67
AUTO POSITION POLLING	Selects the AUTO POSITION POLLING operation type	AUTO POS REQUEST	77
AUTO POS INTERVAL	Selects the transmission interval of AUTO POSITION POLLING signal	30 sec	77
AUTO CHANNEL CHANGE	Selects the delay time to move to the requested channel automatically after receiving a distress call, All Ship call, or group call	30 sec	119
NO ACTION TIMER	Selects the delay time to return to radio operation automatically after no key press	15 min	120
POS UNFIX WAITING TIME	Sets the maximum wait time to obtain position information when receiving a distress call, POS Report call, or acknowledgement to POS request call	15 sec	120
DSC BEEP	Turns on or off the audible alarm when receiving a DSC call	INDIVIDUAL CALL: ON GROUP CALL: ON ALL SHIPS: ON POS REQUEST: OFF POS REPORT: ON GEOGRAPHICAL: ON POLLING CALL: OFF DSC TEST CALL: OFF	120

18 GPS SETUP

The “GPS Setup” mode allows the parameters for the NMEA2000 or the NMEA-0183 or the optional **SCU-31** external GPS antenna to be customized for your operating requirements.

18.1 ORDER OF PRIORITY

Specify the order of priority of the connection devices to be used when obtaining location information.

1.  ►► “**SETUP**” ►► “**GPS SETUP**” ►► “**ORDER OF PRIORITY**”

2. Rotate the **DIAL/ENT** knob to select “**NMEA2000**” or “**NMEA-0183**” then press the **[ENTER]** soft key to save the new setting.

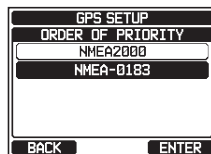

3. Press the **CLEAR** key to return to radio operation.

NOTE

The SUC-31 external GPS antenna is always set as the lowest priority.

18.2 COMPASS DIRECTION

This menu item selects the compass direction to be shown on the **GX6000** display. The default setting is “**COURSE-UP**”.

1.  ►► “**SETUP**” ►► “**GPS SETUP**” ►► “**COMPASS DIRECTION**”

2. Rotate the **DIAL/ENT** knob to select the desired direction from “**COURSE-UP**” and “**NORTH-UP**”.

3. Press the **[ENTER]** soft key to save the new setting.

4. Press the **CLEAR** key to return to radio operation.

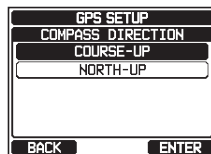

18.3 LOCATION FORMAT

This menu item selects the coordinate system to be shown on the **GX6000** display. The default setting is “**ddd°mm.mmmm**”.

1.  ►► “**SETUP**” ►► “**GPS SETUP**” ►► “**LOCATION FORMAT**”

- Rotate the **DIAL/ENT** knob to select the desired coordinate system. The location format can be selected from “ddd°mm.mmmm” and “ddd°mm’s’s”.
- Press the **[ENTER]** soft key to save the new setting.
- Press the **CLEAR** key to return to radio operation.

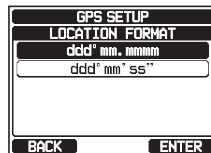

18.4 TIME OFFSET

Sets the local time offset between UTC (Universal Time Coordinated) and local time shown on the display. The offset is added or subtracted from the time received from the GPS.

Refer to section “7.8.1 Changing the GPS Time” for details.

18.5 TIME AREA

This menu selection allows the radio to show UTC time or local time with the offset. Refer to section “7.8.2 Changing the Time Area” for details.

18.6 TIME FORMAT

This menu selection allows the radio to show time in 12-hour or 24-hour format. Refer to section “7.8.3 Changing the Time Format” for details.

18.7 UNITS OF MEASURE

This section allows you to set the speed, distance and altitude units.

- [MENU]** → “**SETUP**” → “**GPS SETUP**” → “**UNIT OF MEASURE**”

- Rotate the **DIAL/ENT** knob to select the item you want to set.
- Press the **[SELECT]** soft key.
- Rotate the **DIAL/ENT** knob to select the unit.
- Press the **[ENTER]** soft key to store the new setting.
- Press the **CLEAR** key to return to radio operation.

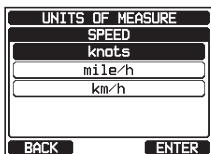
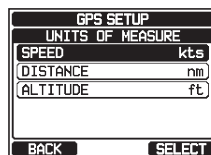

18.8 MAGNETIC VARIATION

This selection allows customizing the GPS COG (Course Over Ground) indication on the normal and compass pages and BRG on the waypoint and AIS pages. Refer to section “7.8.4 Changing COG to True or Magnetic” for details.

NOTE

Setting to “ON” is effective only when the RMC sentences with magnetic data are input from external devices such as a GPS chart plotter.

18.9 NMEA 0183 IN/OUT

18.9.1 Data Speed

This menu is used to setup the NMEA 0183 baud rate of the GPS input (Blue and Green wires) and DSC output (Gray and Brown wires). The default setting is 4800 bps.

When 38400 bps is selected the AIS sentences (VDM) and DSC sentences (DSC & DSE) both are output on the Gray and Brown wires after a DSC distress, position request or AIS transmission is received.

1. [MENU] → "SETUP" → "GPS SETUP" → "NMEA 0183 IN/OUT"

2. Rotate the **DIAL/ENT** knob to select "DATA SPEED", then press the [SELECT] soft key.

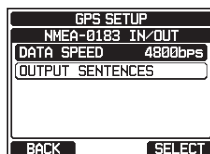

3. Rotate the **DIAL/ENT** knob to select the desired speed from "4800bps" and "38400bps".

4. Press the [ENTER] soft key to save the new setting.

5. Press the **CLEAR** key to return to radio operation.

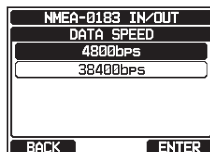

18.9.2 Output Sentences

This selection is used to setup the NMEA output sentences of the **GX6000**. By default, all the NMEA sentences are turned "ON".

1. [MENU] → "SETUP" → "GPS SETUP" → "NMEA 0183 IN/OUT"

2. Rotate the **DIAL/ENT** knob to select "OUTPUT SENTENCES", then press the [SELECT] soft key.

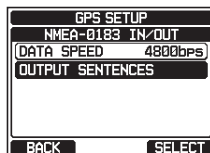

3. Rotate the **DIAL/ENT** knob to select the desired sentence type, then press the [SELECT] soft key.

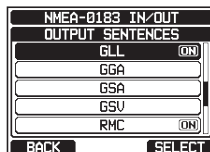

4. Rotate the **DIAL/ENT** knob to select “**ON**” or “**OFF**”.
5. Press the **[ENTER]** soft key to save the new setting.
6. Repeat steps 3 through 5 to set the other sentences.
7. Press the **CLEAR** key to return to radio operation.

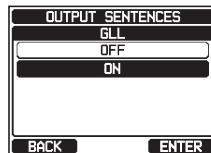

NOTE

- Data output will be performed based on the data acquisition order of priority configured from “ORDER OF PRIORITY”. Refer to section “**18.1 ORDER OF PRIORITY**” for details.
- While “UNIT POWER” of “OPTION GPS UNIT” is set to OFF, NMEA sentences will not be output. (OPTION GPS reception data will be output as is.)
- The output interval of each NMEA sentence depends on the output timing on the input device. However, sentences which include POS data will be output at intervals of two seconds or less.
- When all sentences are set to be output, depending on the baud rate, not all sentences can be output at intervals of one second or less. GSA and GSV sentences will be output at intervals of around five seconds.

18.10 Position Data Output

Select the connection device to be used when outputting position data.

1. **[MENU]** → “**SETUP**” → “**GPS SETUP**” → “**OPTION GPS UNIT**”

2. Rotate the **DIAL/ENT** knob to select “**POS DATA OUTPUT**”, then press the **[SELECT]** soft key.

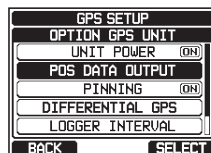

3. Rotate the **DIAL/ENT** knob to select “**NMEA 2000**” or “**NMEA 0183**”, then press the **[SELECT]** soft key.

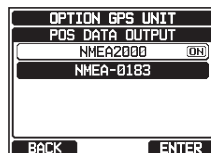

4. Rotate the **DIAL/ENT** knob to select “**OFF**” or “**ON**”.
5. Press the **[ENTER]** soft key to store the new setting.
6. Press the **CLEAR** key to return to radio operation.

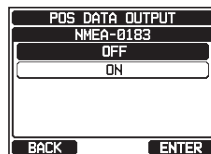

18.11 OPTION GPS UNIT

Change the optional GPS Antenna (**SCU-31**) setting.

18.11.1 Unit Power

When you use the **SCU-31**, set this selection to “ON”. The default setting is “OFF”.

1.  → “**SETUP**” → “**GPS SETUP**” → “**OPTION GPS UNIT**”

2. Rotate the **DIAL/ENT** knob to select “**UNIT POWER**”, then press the [**SELECT**] soft key.

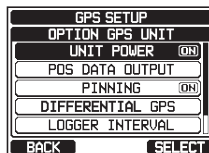

3. Rotate the **DIAL/ENT** knob to select “**OFF**” or “**ON**”.

4. Press the [**ENTER**] soft key to store the new setting.

5. Press the **CLEAR** key to return to radio operation.

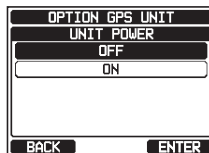

18.11.2 Pinning

This selection is used to enable or disable position updates when the vessel is not underway. The default setting is “ON”.

1.  → “**SETUP**” → “**GPS SETUP**” → “**OPTION GPS UNIT**”

2. Rotate the **DIAL/ENT** knob to select “**PINNING**”, then press the [**SELECT**] soft key.

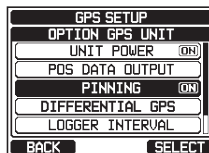

3. Rotate the **DIAL/ENT** knob to select “**OFF**” or “**ON**”.

ON: When pinning is turned on, the **GX6000** will not update its position unless the ship’s speed over approximately 0.4 knot.

OFF: When the vessel is underway or stopped, the **GX6000** continuously updates its position. This improves accuracy of the position fix.

4. Press the [**ENTER**] soft key to save the new setting.

5. Press the **CLEAR** key to return to radio operation.

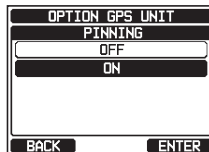

18.11.3 Differential GPS

This selection enables or disables differential GPS function by SBAS (Satellite Based Augmentation System) such as WAAS, EGNOS and MSAS. In some areas (Australia for example), the GPS reception can have problems on enabling the SBAS. The default setting is “OFF”.

1.  → “**SETUP**” → “**GPS SETUP**” → “**OPTION GPS UNIT**”

2. Rotate the **DIAL/ENT** knob to select “**DIFFERENTIAL GPS**”, then press the [**SELECT**] soft key.

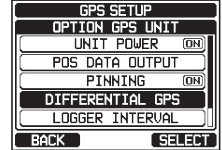

3. Rotate the **DIAL/ENT** knob to select “**OFF**” or “**ON**”.
4. Press the [**ENTER**] soft key to store the new setting.
5. Press the **CLEAR** key to return to radio operation.

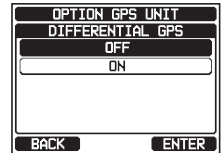

18.11.4 Logger Interval

1.  → “**SETUP**” → “**GPS SETUP**” → “**OPTION GPS UNIT**”

2. Rotate the **DIAL/ENT** knob to select “**LOGGER INTERVAL**”, then press the [**SELECT**] soft key.

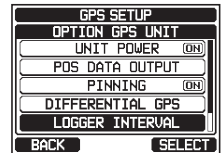

3. Rotate the **DIAL/ENT** knob to select the desired time and press the [**ENTER**] soft key.

Note: Log time for each logger interval setting

15 sec: Aprox. 25 hours

30 sec: Aprox. 50 hours

1 min: Aprox. 100 hours

2 min: Aprox. 200 hours

5 min: Aprox. 500 hours

4. Press the **CLEAR** key to return to radio operation.

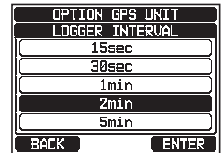

18.11.5 Log Erase

1.  → “**SETUP**” → “**GPS SETUP**” → “**OPTION GPS UNIT**”

2. Rotate the **DIAL/ENT** knob to select “**LOG ERASE**”, then press the **[SELECT]** soft key.

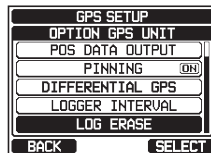

3. Press the **[YES]** soft key. (To cancel, press the **[NO]** soft key.)

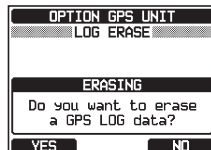

4. Press the **[OK]** soft key.

5. Press the **CLEAR** key to return to radio operation.

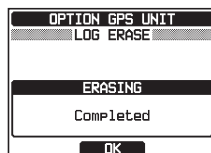

18.12 SUMMARY OF THE GPS SETUP

Item	Description	Default Value	Page
ORDER OF PRIORITY	Sets the order of priority of the connection devices when obtaining position information	NMEA-0183	122
COMPASS DIRECTION	Selects the compass direction to be displayed	COURSE-UP	122
LOCATION FORMAT	Selects the coordinate system to be displayed	ddd°mm.mmmm	122
TIME OFFSET	Sets the offset time from the UTC (available only when “LOCAL” is selected in the item “TIME AREA”)	00:00	123
TIME AREA	Selects the time location to be displayed, from UTC or local	UTC	123
TIME FORMAT	Selects the time format to be displayed, 12-hour or 24-hour (fixed to “24H” when “UTC” is selected in the item “TIME AREA”)	24hour	123
UNITS OF MEASURE	Selects the unit of measure when displaying speed, distance, and altitude	SPEED: kts (knots) DISTANCE: nm (nautical mile) ALTITUDE: ft (feet)	123
MAGNETIC VARIATION	Enables/disables the magnetic variation function	OFF	123
NMEA 0183 IN/OUT			
DATA SPEED	Sets the NMEA 0183 data speed	4800bps	124

Item	Description	Default Value	Page
OUTPUT SENTENCES	Enables/disables NMEA sentences	GLL: ON GGA: ON GSA: ON GSV: ON RMC: ON DSC/DSE: ON	124
POS DATA OUTPUT	Selects the connection device when outputting position data	NMEA 2000: OFF NMEA-0183: OFF	125
OPTION GPS UNIT			
UNIT POWER	Enables/disables the OPTION GPS UNIT	OFF	126
PINNING	Turns on or off GPS position updates for vessel not underway	OFF	126
DIFFERENTIAL GPS	Turns on or off of use of SBAS	ON	127
LOGGER INTERVAL	Selects the interval time of logging	2 min	127
LOG ERASE	Erases the log data	-	128

19 SSM-70H (RAM4) REMOTE MIC OPERATION

When a remote microphone is connected to the **GX6000**, all VHF, DSC, setup menus, AIS, Navigation, GM (Group Monitor) functions and PA/Fog modes can be remotely operated. The **SSM-70H**'s operation is same as **GX6000** except the receiver audio volume setting and squelch level setting. The reason for the same operation is to make the operation of the radio and **SSM-70H** mic easy. For specific operation of the **SSM-70H** mic review sections in the radio manual. The **SSM-70H** is supplied with 23 feet (7 m) of routing cable and can be extended up to 70 feet (21 m) using two 23 feet (7 m) extension cables model **CT-100**. The Intercom feature can be used between the **SSM-70H** and the **GX6000**. In addition, speaker wires are supplied at the panel mount of the routing cable for external speakers to be connected in noisy environments.

19.1 REMOTE MIC CONTROLS

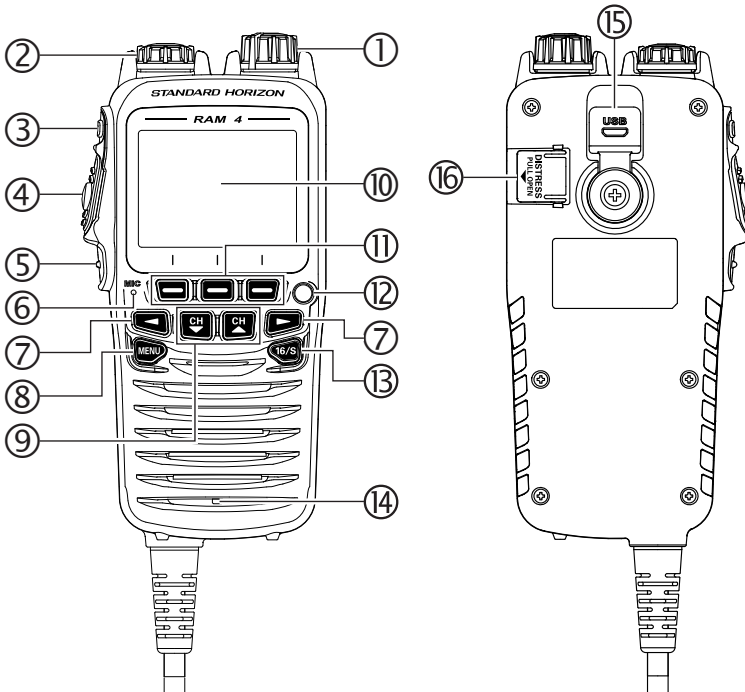

- ① **Power/VOL knob**
Press and hold this knob to turn the transceiver and the remote mic on or off. Rotate this knob to adjust the internal speaker volume.
- ② **DIAL/ENT knob**
While the normal screen is displayed, rotate the **DIAL/ENT** knob to select your desired channel. While the MENU screen is displayed, rotate the knob to select your desired menu item.

SECONDARY USE

Press this knob to enter a selection in the MENU.

③ **SQL** key (Squelch control)

Press this key to activate the squelch adjusting mode. Press the **CH▲** or **CH▼** key to adjust the squelch threshold level.

④ **PTT** (Push-To-Talk) switch

Push this switch to enable the transmitter.

⑤ **CLEAR/On** key

Press this key to cancel a menu selection. Press and hold this key to activate the key lock function. Press and hold this key again to deactivate the key lock function.

⑥ Microphone

The internal microphone transmits your voice reducing background noise using Clear Voice Noise Reduction Technology.

Note: Position your mouth about 1/2" (1.5 cm) away from the microphone hole and speak in a normal voice.

⑦ **◀/▶** key

Press these keys to switch the function of soft keys

SECONDARY USE

While the MENU screen is displayed, press the key to slide the on-screen menu to the right/left side.

⑧ **MENU** key

Press this key to access the MENU.

⑨ **CH▼/CH▲** key

These keys are used to change the operating channel.

Press the key momentarily, the channel increases/decreases one step.

Holding the key, the channel increases/decreases continuously.

SECONDARY USE

- While the MENU screen is displayed, press the key to slide the on-screen menu upward/downward.

- When in the PA or Fog mode, press the key to change the channel.

⑩ Display

Full dot matrix display, 222 by 162 pixels.

⑪ Soft keys

These three programmable keys can be customized through the setup menu mode. When pressing one of these keys briefly, the key functions will appear at the bottom of the display. Refer to section "**19.2 RAM4 SOFT KEY ASSIGNMENT**" for details.

⑫ Strobe Light

When the [**STROBE**] soft key is pressed, the internationally-recognized Morse Code "S.O.S" message will light and flash repeatedly.

From MENU → SETUP → CONFIGURATION → STROBE LED, you can select one option from "CONTINUOUS", "SOS", "BLINK 1", "BLINK 2" and "BLINK 3".

- ⑬ **16/S** key
Pressing this key immediately recalls channel 16 from any channel location. Holding down this key recalls the SUB channel (The default setting is channel 9). Pressing this key again reverts to the previous selected working channel.
- ⑭ **Speaker**
The internal speaker is located here.
- ⑮ **DATA** jack
Use the micro USB type B jack for **SSM-70H (RAM4)** firmware updates. Note: When the DATA jack is securely covered with rubber cap, the SSM-70H meets the waterproofing performance.
- ⑯ **DISTRESS** key
This key is used to send a DSC distress call. Refer to section “**10 DIGITAL SELECTIVE CALLING (DSC)**”.

19.2 RAM4 SOFT KEY ASSIGNMENT

From this menu, you can assign desired functions to each **RAM4** soft key from numbers 01 to 12. You can also set how long the soft key icon will be displayed after the corresponding soft key is pressed. The keys maybe setup to control the following functions:

DISPLAY	FUNCTION	SOFT KEY NUMBERS ASSIGNED AS DEFAULT (See the next page.)
NONE	-	
TX HI/LO	Selects transmit power.	02
WX/CH	Switches channels between weather and marine.	01
SCAN	Turns on or off scanning function.	05
DUAL WATCH / TRIPLE WATCH	Starts and stops dual watch scan.	06
MARK POSITION	Marks the current position for a “Waypoint”.	
SCAN MEMORY	Add or remove channels from memory channel scan.	04
PRESET	Programs or deletes the preset memory channel.	09
MAN OVER BOARD	Marks the position where a person falls overboard.	03
NOISE CANCEL	Enables the noise canceling settings display.	
CH NAME	Edit channel names.	
STROBE*	Turns on or off the strobe light LED.	10
SCRAMBLER	Configures the secret communication settings.	
COMPASS	Enables the “Compass” display.	
NAVIGATION	Enables the “Waypoint” or “Route” navigation display.	11
FOG HORN	Select FOG HORN mode.	08
INTERCOM	Activates intercom between radio and RAM4 mic (optional RAM4 required).	07
GPS LOGGER	Starts and stops logging position data.	
AIS DISPLAY	Shows the “AIS” display.	12
HORN BUTTON	Activates the Fog Horn function.	
PUBLIC ADDRESS	Activates the PA function.	
RX RECORD	Records received voices.	
RX SENSE	Toggles between LOCAL and DISTANCE.	
PLAY	Plays recorded voices.	

(*: SSM-70H (RAM4) and SSM-71H (RAM4W) only)

NOTE

You can assign functions to soft keys on each of the transceiver and the optional **SSM-70H (RAM4)** remote mic.

19.2.1 Key Assignment

Configure all settings on the **SSM-70H (RAM4)** remote mic for which you want to assign functions to soft keys.

1. **[MENU]** **»»»** **“SETUP”** **»»»** **“CONFIGURATION”** **»»»** **“SOFT KEY”**

2. Rotate the **DIAL/ENT** knob to select **“KEY ASSIGNMENT”**, then press the **[SELECT]** soft key.

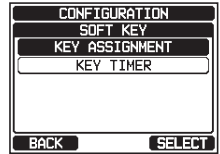

3. Rotate the **DIAL/ENT** knob to select the key number to be programmed, and press the **[SELECT]** soft key.

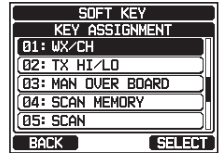

4. Rotate the **DIAL/ENT** knob to select a new function to be assigned, and press the **[ENTER]** soft key. Available functions are listed below. By selecting **“NONE”** the soft key assignment is removed.

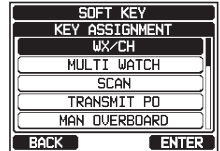

5. Repeat steps 3 and 4 to program other soft keys.

The VHF radio's functions can be assigned to the maximum of 12 soft keys. Pressing the **▶/◀** key each time shows three different soft keys.

6. Press the **CLEAR/Off** key to return to radio operation.

20 CONNECTING A USB DATA TERMINAL TO THE PC

The GX6000 settings can be programmed using the USB terminal and PC Programming Software. You can also download the log data from the radio by using the PC Programming Software which may be downloaded from the Standard Horizon website. The PC Programming Software is compatible with Windows®.

To connect a PC, use the supplied USB cable through the **DATA** jack of the **GX6000**.

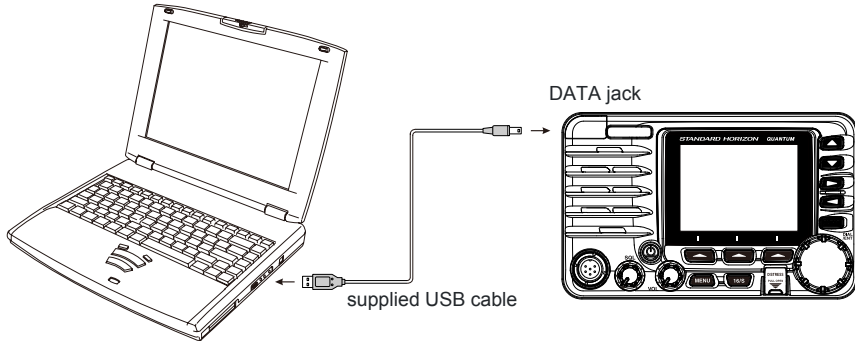

CAUTION

The **DATA** jack is NOT designed to be waterproof when the cover is opened. Connect the radio and PC in a dry location.

If you have further questions, please feel free to contact Product Support at:
Phone: (800) 767-2450
Email: marinetech@yaesu.com

21 MAINTENANCE

The inherent quality of the solid-state components used in this transceiver will provide many years of continuous use. Taking the following precautions will prevent damage to the transceiver.

- Never key the microphone unless an antenna or suitable dummy load is connected to the transceiver.
- Ensure that the supply voltage to the transceiver does not exceed 16 VDC or fall below 11 VDC.
- Use only STANDARD HORIZON approved accessories and replacement parts.

In the unlikely event of serious problems, please contact your Dealer or our repair facility. Address and phone numbers for this facility, as well as warranty information, are contained in section “**23 WARRANTY**”.

21.1 REPLACEMENT PARTS

Occasionally an owner needs a replacement mounting bracket or knob. These can be ordered from our Parts Department by emailing yaesuparts@yaesu.com or calling:

Marine Division of YAESU U.S.A.

6125 Phyllis Drive, Cypress, California 90630

Telephone (714) 827-7600

Commonly requested parts, and their part numbers are listed below.

- **Speaker Microphone:** SSM-76H
- **Power Cord:** T9027407
- **VOL and SQL Knob:** RA6057800
- **DIAL/ENT Knob:** RA6057700
- **Mounting Bracket:** RA6060600
- **Mounting Bracket Knob:** RA0978600
- **Microphone Hanger:** RA0458800
- **RAM4 Mic Routing Cable Assembly:** S8101512
- **USB Cable:** T9101648

21.2 FACTORY SERVICE

In the unlikely event that the radio fails to perform or needs servicing, please contact the following:

Standard Horizon

Attention Marine Repair Department

6125 Phyllis Drive, Cypress, California 90630, U.S.A.

Telephone (800) 366-4566

For repairs in Canada

Westcom Marine

488 East 62nd Avenue Vancouver BC V5X2G1

Telephone (604) 327-6280

An "RA" (Return Authorization) number is not necessary to send a product in for service. Include a brief note describing the problem along with your name, return address, phone number, and proof of purchase.

21.3 TROUBLESHOOTING CHART

SYMPTOM	PROBABLE CAUSE	REMEDY
Transceiver fails to power up.	No DC voltage to the transceiver, or blown fuse.	a. Check the 12VDC battery connections and the fuse. b. The  key needs to be pressed and held to turn the radio on.
Transceiver blows fuse when connected to power supply.	Reversed power wires.	Check the power cable for DC voltage, or replace the fuse (7A). Make sure the red wire is connected to the positive (+) battery post, and the black wire is connected to the negative (-) battery post. If the fuse still blows, contact your Dealer.
Popping or whining noise from the speaker while engine runs.	Engine noise.	Re-route the DC power cables away from the engine. Add noise suppressor on power cable. Change to resistive spark plug wires and/or add an alternator whine filter.
Sound is not emitted from the internal or external speaker.	Accessory cable.	Check the connections of the accessory cable. External speaker cable (WHITE/SHIELD) shorted together.
Sound is not emitted from the PA speaker.	Accessory cable.	Check the connections of the accessory cable. PA speaker cable (RED/SHIELD) shorted together.
Receiving station reports low transmit power, even with transceiver set to HI power.	Antenna.	Have the antenna checked or test the transceiver with another antenna. If the problem persists, contact your Dealer for servicing.
“HI BATTERY” or “LO BATTERY” message appears when the power is turned on.	The power supply voltage is too high or too low.	Confirm that the connected power supply voltage is between 11 volts and 16.5 volts DC.
Your position is not displayed.	SCU-31 cable.	Check the SCU-31 cable connection.
	Accessory cable.	Check the accessory cable connection. Some GPS use the battery ground for NMEA connection.
	Setting of the GPS chart plotter.	Check the output signal format of the GPS navigation receiver. This radio requires NMEA 0183 and NMEA 2000 format with GLL, RMB, or RMC sentence as an output signal. If the GPS has a baud rate setting make sure to select 4800 and parity to NONE.

22 CHANNEL ASSIGNMENTS

Tables on the following columns list the VHF Marine Channel assignments for U.S.A. and International use. Below are listed some data about the charts.

1. VTS. Where indicated, these channels are part of the U.S. Coast Guard's Vessel Traffic System.
2. Alpha channel numbers, that is, channel numbers followed by the letter A (such as Channel 07A) are **simplex** channels on the U.S.A. or Canadian channel assignments whose counterparts in the International assignments are **duplex** channels. International channels do not use "alpha" numbers. If you call the Coast Guard on Channel 16, they will sometimes ask you to "**go to channel 22 Alpha**". This is a channel assigned to U.S.A. and Canadian Coast Guards for handling distress and other calls. If your radio is set for **International** operation you will go to Channel 22 instead of 22A, and will not be able to communicate with the Coast Guard. To use Channel 22A, your radio must be set for **USA** or **Canada** operation, usually by a U/I/C (USA/International/Canada) control or combination of controls. Channel 22 (without an "A") is an **International** duplex channel for port operations. Some radios indicate an "A" adjacent to the alpha channels on the display; on others "alpha" is not indicated but the proper channel is selected based on the U/I/C setting.
3. Bridge-to-Bridge channels (for example, Channel 13) are for use by bridge operators on inter-coastal waterways and rivers. It is also used by marine vessels in the vicinity of these bridges for navigation and for communicating with the bridge operators. Note that a limit of 1 Watt is specified for these channels.
4. The **S/D** column on the chart indicates either S (simplex) or D (duplex). **Simplex** means transmitting and receiving on the same frequency. Only one party at a time can talk, unlike a telephone. Be sure to say "**over**" and release your microphone push-to-talk switch at the end of each transmission. **Duplex** operation involves the use of one frequency for transmitting and a separate frequency for receiving. On channels specified as duplex on the charts, correct mode of operation is established automatically by your radio when you select a channel; you cannot change the mode. And you still must release the push-to-talk switch after each transmission in order to listen to the radio.
5. Channels normally used by recreational boaters are those that include the term "non-commercial" in the **Channel Use** column of the chart. Some of these are shared with other users and some are used only in certain geographic regions.

6. Marine vessels equipped with VHF radios are required to monitor Channel 16.
7. 156.050 MHz and 156.175 MHz are available for port operations and commercial communications purposes when used only within the U.S. Coast Guard designated Vessel Traffic Services (VTS) area of New Orleans, on the lower Mississippi River from the various pass entrances in the Gulf of Mexico to Devil's Swamp Light at River Mile 242.4 above head of passes near Baton Rouge.
8. 156.250 MHz is available for port operations communications use only within the U.S. Coast Guard designated VTS radio protection areas of New Orleans and Houston described in Sec. 80.383. 156.250 MHz is available for intership port operations communications used only within the area of Los Angeles and Long Beach harbors, within a 25- nautical mile radius of Point Fermin, California.
9. 156.550 MHz, 156.600 MHz and 156.700 MHz are available in the U.S. Coast Guard designated port areas only for VTS communications and in the Great Lakes available primarily for communications relating to the movement of ships in sectors designated by the St. Lawrence Seaway Development Corporation or the U.S. Coast Guard. The use of these frequencies outside VTS and ship movement sector protected areas is permitted provided they cause no interference to VTS and ship movement communications in their respective designated sectors.
10. Use of 156.875 MHz is limited to communications with pilots regarding the movement and docking of ships. Normal output power must not exceed 1 watt. 5: 156.375 MHz and 156.650 MHz are available primarily for intership navigational communications. These frequencies are available between coast and ship on a secondary basis when used on or in the vicinity of locks or drawbridges. Normal output power must not exceed 1 watt. Maximum output power must not exceed 10 watts for coast stations or 25 watts for ship stations.
11. On the Great Lakes, in addition to bridge-to-bridge communications, 156.650 MHz is available for vessel control purposes in established vessel traffic systems. 156.650 MHz is not available for use in the Mississippi River from South Pass Lighted Whistle Buoy "2" and Southwest Pass entrance Mid-channel Lighted Whistle Buoy to mile 242.4 above Head of Passes near Baton Rouge. Additionally, it is not available for use in the Mississippi River-Gulf Outlet, the Mississippi River-Gulf Outlet Canal, and the Inner Harbor Navigational Canal, except to aid the transition from these areas.
12. Use of 156.375 MHz is available for navigational communications only in the Mississippi River from South Pass Lighted Whistle Buoy "2" and South-

west Pass entrance Mid channel Lighted Whistle Buoy to mile 242.4 above head of Passes near Baton Rouge, and in addition over the full length of the Mississippi River-Gulf Outlet Canal from entrance to its junction with the Inner Harbor Navigation Canal, and over the full length of the Inner Harbor Navigation Canal from its junction with the Mississippi River to its entry to Lake Pontchartrain at the New Seabrook vehicular bridge.

13. Within 120 km (75 miles) of the United States/Canada border, in the area of the Puget Sound and the Strait of Juan de Fuca and its approaches, 157.425 MHz is half of the duplex pair designated as Channel 88. In this area, Channel 88 is available to ship stations for communications with public coast stations only. More than 120 km (75 miles) from the United States/Canada border in the area of the Puget Sound and the Strait of Juan de Fuca, its approaches, the Great Lakes, and the St. Lawrence Seaway, 157.425 MHz is available for intership and commercial communications. Outside Puget Sound area and its approaches and the Great Lakes, 157.425 MHz is also available for communications between commercial fishing vessels and associated aircraft while engaged in commercial fishing activities.
14. When the frequency 156.850 MHz is authorized, it may be used additionally for search and rescue training exercises conducted by state or local governments.
15. The frequency 156.850 MHz is additionally available to coast stations on the Great Lakes for transmission of scheduled Coded Marine Weather Forecasts (MAFOR), Great Lakes Weather Broadcast (LAWEB) and scheduled Notices to Mariners or Bulletins. F3C and J3C emissions are permitted. Coast Stations on the Great Lakes must cease weather broadcasts which cause interference to stations operating on 156.800 MHz until the interference problem is resolved.
16. The frequency 157.100 MHz is authorized for search and rescue training exercises by state or local government in conjunction with U.S. Coast Guard stations. Prior U.S. Coast Guard approval is required. Use must cease immediately on U.S. Coast Guard request.
17. The duplex pair for channel 20 (157.000/161.600 MHz) may be used for ship to coast station communications.
18. Available for assignment to coast stations, the use of which is in accord with an agreed program, for the broadcast of information to ship stations concerning the environment.

VHF MARINE CHANNEL CHART							
CH	U	C	I	S/D	TX	RX	CHANNEL USE
01		X	X	D	156.050	160.650	Public Correspondence (Marine Operator)
1001	X			S	156.050		Port Operation and Commercial. VTS in selected areas
02		X	X	D	156.100	160.700	Public Correspondence (Marine Operator)
03		X	X	D	156.150	160.750	Public Correspondence (Marine Operator)
1003	X			S	156.150		U.S. Government Only, Coast Guard
04			X	D	156.200	160.800	Public Correspondence (Marine Operator), Port operation, ship movement
1004		X		S	156.200		Pacific coast: Coast Guard, East Coast: Commercial fishing
05			X	D	156.250	160.850	Public Correspondence (Marine Operator), Port operation, ship movement
1005	X	X		S	156.250		Port operation. VTS in Seattle
06	X	X	X	S	156.300		Inter-ship Safety
07			X	D	156.350	160.950	Public Correspondence (Marine Operator), Port operation, ship movement
1007	X	X		S	156.350		Commercial
08	X	X	X	S	156.400		Commercial (Inter-ship only)
09	X	X	X	S	156.450		Boater Calling channel, Commercial & Non-commercial (Recreational)
10	X	X	X	S	156.500		Commercial
11	X	X	X	S	156.550		Commercial. VTS in selected areas.
12	X	X	X	S	156.600		Port operation. VTS in selected areas.
13	X	X	X	S	156.650		Inter-ship Navigation Safety (Bridge-to-bridge)
14	X	X	X	S	156.700		Port operation. VTS in selected areas.
15	X			S	---	156.750	Environmental (Receive only)
15		X	X	S	156.750		Commercial, non-commercial, ship movement (1 W)
16	X	X	X	S	156.800		International Distress, Safety and Calling
17	X	X	X	S	156.850		State Controlled (1 W)
18			X	D	156.900	161.500	Port operation, ship movement
1018	X	X		S	156.900		Commercial
19			X	D	156.950	161.550	Port operation, ship movement
1019	X	X		S	156.950		Commercial (USA) Coast Guard (Canada)
1019			X	S	156.950		
2019			X	S	161.550		
20	X	X	X	D	157.000	161.600	Canadian Coast Guard Only, International: port operations and shipment
1020			X	S	157.000		
1020	X			S	157.000		Port operation
2020			X	S	161.600		
21			X	D	157.050	161.650	Port operation, ship movement
1021	X	X		S	157.050		U.S. Government Only (USA) Canadian Coast Guard (Canada)
2021		X			---	161.650	CMB Service
22			X	D	157.100	161.700	Port operation, ship movement
1022	X	X		S	157.100		US Coast Guard Liaison and Maritime Safety Information Broadcasts announced on channel 16 (USA) Canadian Coast Guard Liaison and Maritime Safety Information Broadcasts announced on channel 16 (Canada)

VHF MARINE CHANNEL CHART							
CH	U	C	I	S/D	TX	RX	CHANNEL USE
23		X	X	D	157.150	161.750	Public Correspondence (Marine Operator)
1023	X			S	157.150		U.S. Government Only
2023		X			---	161.750	CMB Service
24	X	X	X	D	157.200	161.800	Public Correspondence (Marine Operator)
25	X	X	X	D	157.250	161.850	Public Correspondence (Marine Operator)
2025		X			---	161.850	CMB Service
26	X	X	X	D	157.300	161.900	Public Correspondence (Marine Operator)
27	X	X	X	D	157.350	161.950	Public Correspondence (Marine Operator)
28	X	X	X	D	157.400	162.000	Public Correspondence (Marine Operator)
2028		X			---	162.000	CMB Service
60		X	X	D	156.025	160.625	Public Correspondence (Marine Operator)
61			X	D	156.075	160.675	Public Correspondence (Marine Operator), Port operation, ship movement
1061	X	X		S	156.075		Public Coast: Coast Guard; East Coast: commercial fishing only
62			X	D	156.125	160.725	Public Correspondence (Marine Operator), Port operation, ship movement
1062		X		S	156.125		Public Coast: Coast Guard; East Coast: commercial fishing only
63			X	D	156.175	160.775	Public Correspondence (Marine Operator), Port operation, ship movement
1063	X	X		S	156.175		Port Operation and Commercial. VTS in selected areas.
64		X	X	D	156.225	160.825	Public Correspondence (Marine Operator), Port operation, ship movement
1064	X	X		S	156.225		Public Correspondence (Marine Operator), Port operation, ship movement
65			X	D	156.275	160.875	Public Correspondence (Marine Operator), Port operation, ship movement
1065	X	X		S	156.275		Port Operations
66			X	D	156.325	160.925	Public Correspondence (Marine Operator), Port operation, ship movement
1066	X	X		S	156.325		Port Operations
67	X	X	X	S	156.375		US: Commercial. Used for Bridge-to-bridge communications in lower Mississippi River. Inter-ship only. Canada: Commercial fishing, S&R
68	X	X	X	S	156.425		Non-commercial (Recreational)
69	X	X	X	S	156.475		US: Non-commercial (Recreational), Canada: Commercial fishing only, International: Inter-ship, Port operations and Ship movement
70	X	X	X	S	---	156.525	Digital selective calling (voice communications not allowed)
71	X	X	X	S	156.575		US, Canada: Non-commercial (Recreational), International: Port operations and Ship movement
72	X	X	X	S	156.625		Non-commercial (Inter-ship only)
73	X	X	X	S	156.675		US: Port Operations, Canada: Commercial fishing only, International: Inter-ship, Port operations and Ship movement

VHF MARINE CHANNEL CHART								
CH	U	C	I	S/D	TX		RX	CHANNEL USE
74	X	X	X	S	156.725			US: Port Operations, Canada: Commercial fishing only, International: Inter-ship, Port operations and Ship movement
75	X	X	X	S	156.775			Port Operations (Inter-ship only) (1 W)
76	X	X	X	S	156.825			Port Operations (Inter-ship only) (1 W)
77	X	X		S	156.875			Port Operations (Inter-ship only) (1 W)
77			X	S	156.875			Port Operations (Inter-ship only)
78			X	D	156.925	161.525		Public Correspondence (Marine Operator), Port operation, ship-movement
1078	X	X		S	156.925			Non-commercial (Recreational)
1078			X	S	156.925			Port operation and Ship movement
2078			X	S	161.525			
79			X	D	156.975	161.575		Port operation and Ship movement
1079	X	X		S	156.975			Commercial
1079			X	S	156.975			Port operation and Ship movement
2079			X	S	161.575			
80			X	D	157.025	161.625		Port operation, ship movement
1080	X	X		S	157.025			Commercial
81			X	D	157.075	161.675		Port operation, ship movement
1081	X	X		S	157.075			U.S. Government Only - Environmental protection operations. (USA) Canadian Coast Guard Only (Canada)
82			X	D	157.125	161.725		Public Correspondence (Marine Operator), Port operation, ship movement
1082	X	X		S	157.125			U.S. Government Only (USA) Canadian Coast Guard Only (Canada)
83			X	D	157.175	161.775		Public Correspondence (Marine Operator)
1083	X	X		S	157.175			U.S. Government Only (USA) Canadian Coast Guard Only (Canada)
2083		X			---	161.775		CMB Service
84	X	X	X	D	157.225	161.825		Public Correspondence (Marine Operator)
85	X	X	X	D	157.275	161.875		Public Correspondence (Marine Operator)
86	X	X	X	D	157.325	161.925		Public Correspondence (Marine Operator)
87	X	X	X	S	157.375			Port operation, ship movement
88	X	X	X	S	157.425			Port operation, ship movement Commercial, Inter-ship Only

NOTE: Simplex channels, 1003, 1021, 1023, 1061, 1064, 1081, 1082 and 1083 CANNOT be lawfully used by the general public in U.S.A. waters.

23 WARRANTY

Marine Products Limited Warranty

PLEASE NOTE

The following "Limited Warranty" is for valid for products that have been purchased in the United States and Canada. For limited Warranty details outside the United States, contact the dealer in your country.

STANDARD HORIZON (a division of YAESU U.S.A.) warrants, to the original purchaser only, each new Marine Communications Product ("Product") manufactured and/or supplied by STANDARD HORIZON against defects in materials and workmanship under normal use and service for a period of time from the date of purchase as follows:

Fixed Mount and Portable Transceivers

1 year - if purchased before 01/01/91

3 years - if purchased between 01/01/91 and 01/01/94

3 years Waterproof - if purchased after 01/01/94

Loud hailers

1 year - if purchased before 01/01/91

3 years - if purchased after 01/01/91

Associated Chargers

1 year - if purchased before 01/01/91

3 years - if purchased after 01/01/91

Associated Batteries - 1 year. Note: Batteries will be deemed defective only if storage capacity drops below 80% of rated capacity or if leakage develops.

Associated Accessories - 1 year. Includes: Microphones/Handsets, External Speakers, Antennas, Carrying Accessories, Power Supplies, and Signaling Boards.

To receive warranty service, the purchaser must deliver the Product, transportation and insurance prepaid, to STANDARD HORIZON, Attention Marine repairs 6125 Phyllis Drive, Cypress, California 90630, U.S.A. Include proof of purchase indicating model, serial number, and date of purchase. STANDARD HORIZON will return the Product to the purchaser freight prepaid. Products purchased prior to January 1, 1991 will bear the STANDARD HORIZON warranty terms in effect prior to that date.

In the event of a defect, malfunction or failure of the Product during the warranty period, STANDARD HORIZON's liability for any breach of contract or any breach of express or implied warranties in connection with the sale of Products shall be limited solely to repair or replacement, at its option, of the Product or

part(s) therein which, upon examination by STANDARD HORIZON, appear to be defective or not up to factory specifications. STANDARD HORIZON may, at its option, repair or replace parts or subassemblies with new or reconditioned parts and subassemblies. Parts thus repaired or replaced are warranted for the balance of the original applicable warranty.

STANDARD HORIZON will not warrant installation, maintenance or service of the Products. In all instances, STANDARD HORIZON's liability for damages shall not exceed the purchase price of the defective Product.

This warranty only extends to Products sold within the 50 States of the United States of America and the District of Columbia.

STANDARD HORIZON will pay all labor to repair the product and replacement parts charges incurred in providing the warranty service except where purchaser abuse or other qualifying exceptions exist. The purchaser must pay any transportation expenses incurred in returning the Product to STANDARD HORIZON for service.

This limited warranty does not extend to any Product which has been subjected to misuse, neglect, accident, incorrect wiring by anyone other than STANDARD HORIZON, improper installation, or subjected to use in violation of instructions furnished by STANDARD HORIZON, nor does this warranty extend to Products on which the serial number has been removed, defaced, or changed. STANDARD HORIZON cannot be responsible in any way for ancillary equipment not furnished by STANDARD HORIZON which is attached to or used in connection with STANDARD HORIZON's Products, or for the operation of the Product with any ancillary equipment, and all such equipment is expressly excluded from this warranty. STANDARD HORIZON disclaims liability for range, coverage, or operation of the Product and ancillary equipment as a whole under this warranty. STANDARD HORIZON reserves the right to make changes or improvements in Products, during subsequent production, without incurring the obligation to install such changes or improvements on previously manufactured Products.

The implied warranties which the law imposes on the sale of this Product are expressly LIMITED, in duration, to the time period specified above. STANDARD HORIZON shall not be liable under any circumstances for consequential damages resulting from the use and operation of this Product, or from the breach of this LIMITED WARRANTY, any implied warranties, or any contract with STANDARD HORIZON. IN CONNECTION WITH THE SALE OF ITS PRODUCTS, STANDARD HORIZON MAKES NO WARRANTIES, EXPRESS OR IMPLIED AS TO THE MERCHANTABILITY OR FITNESS FOR A PARTICULAR PURPOSE OR OTHERWISE, EXCEPT AS EXPRESSLY SET FORTH HEREIN.

Some states do not allow the exclusion or limitation of incidental or consequential damages, or limitation on how long an implied warranty lasts, so the above limitations or exclusions may not apply. This warranty gives specific legal rights, and there may be other rights which may vary from state to state.

ONLY PRODUCTS SOLD ON OR AFTER JANUARY 1, 1991 ARE COVERED UNDER THE TERMS OF THIS LIMITED WARRANTY.

ON-LINE WARRANTY REGISTRATION

THANK YOU for buying STANDARD HORIZON (a division of YAESU U.S.A.) products! We are confident your new radio will serve your needs for many years!

Please visit **www.standardhorizon.com** to register your Marine VHF. It should be noted that visiting the website from time to time may be beneficial to you, as new products are released they will appear on the STANDARD HORIZON website. Also a statement regarding product support should be added to the manual.

Product Support Inquiries

If you have any questions or comments regarding the use of the radio, you can visit the STANDARD HORIZON website to send an E-Mail or contact the Product Support team at (714) 827-7600 ext 6300 M-F 8:00-5:00 PST.

In addition to the warranty, STANDARD HORIZON includes a lifetime "flat rate" and "customer loyalty" programs to provide service after the warranty period has expired. If you wish to obtain the flat rate price for out-of-warranty repair, you must include the information on the Owner's Record with the unit when you return it to your Dealer or to STANDARD HORIZON.

Lifetime Flat Rate Service Program: For the original Owner only, for the lifetime of the unit, STANDARD HORIZON will repair the unit to original specifications.

Note: The flat rate amount is payable by the Owner only if STANDARD HORIZON or the STANDARD HORIZON Dealer determines that a repair is needed. After the repair, a 90-day warranty will be in effect from the date of return of the unit to the Owner.

This service program is not available for equipment which has failed as a result of neglect, accident, breakage, misuse, improper installation or modification, or water damage (depending on the product).

24 SPECIFICATIONS

Performance specifications are nominal, unless otherwise indicated, and are subject to change without notice. Measured in accordance with TIA/EIA-603.

24.1 GENERAL

Channels	All USA, International and Canadian
Normal Input Voltage	13.8 V DC
Operating Voltage Range	11 V to 16.5 V
Current Drain	
Standby	0.55 A
Receiver (at Maximum AF Output)	0.9 A
Transmit	5.0 A (Hi), 1.0 A (Lo)
DSC Transmitted Call Log	24
DSC Distress Call Log	27
DSC Received Call Log	64
Individual Call Directory	80
Group Call Directory	32
Waypoint Directory	100
Display Type	2.8" x 2" (70 x 51 mm) Full Dot Matrix (222 x 162 pixels)
Dimensions (WxHxD)	6.9" x 4.3" x 6.8" (175.5 x 110 x 173.3 mm)
Flush-Mount Dimensions (WxHxD)	6.2" x 3.7" x 6.2" (157.4 x 93.4 x 158 mm)
Weight	3.7 lbs (1.66 kg)

24.2 TRANSMITTER

Frequency Range	156.025 MHz to 157.425 MHz (USA) 156.025 MHz to 161.600 MHz (INTERNATIONAL)
RF Output Power	25 W (Hi), 1 W (Lo)
Conducted Spurious Emissions	Less than -80 dBc (Hi), -66 dBc (Lo)
Audio Response	within +1/-3dB of a 6 dB/Octave pre-emphasis characteristic at 300 to 3000 Hz
Audio Distortion	Less than 5 %
Modulation	16K0G3E (for Voice), 16K0G2B (for DSC)
Frequency Stability	±0.0003 % (-20°C to +60°C)
FM Hum and Noise	50 dB

24.3 RECEIVER (for Voice and DSC)

Frequency Range	156.050 MHz to 163.275 MHz
Sensitivity	
20 dB Quieting	0.35 µV
12 dB SINAD	0.30 µV
Squelch Sensitivity (Threshold)	0.13 µV
Modulation Acceptance Bandwidth	±7.5 kHz
Selectivity (Typical)	
Spurious and Image Rejection	80 dB for Voice (75 dB for DSC)
Intermodulation and Rejection	80 dB for Voice (75 dB for DSC)
Audio Output	10 W (at 8 ohms external speaker output)
Audio Response	within +1 / -3dB of a 6 dB / Octave de-emphasis characteristic at 300 to 3000 Hz

Frequency Stability	±0.0003 % (–20°C to +60°C)
Channel Spacing	25 kHz
DSC Format	ITU-R M.493-13
Attenuator (Local)	Approx. 10 dB

24.4 RECEIVER (for AIS)

Frequency	161.975 MHz (CH A), 162.025 MHz (CH B)
Sensitivity	0.5 µV (at 12 dB SINAD)
Selectivity(Typical)	
Spurious and Image Rejection	70 dB
Intermodulation and Rejection	70 dB

24.5 NMEA INPUT/OUTPUT

4800 Baud selected:

NMEA 0183 Input (4800 baud)	GGA, GLL, GNS, RMC, GSA, & GSV
NMEA 0183 Output (4800 baud)	DSC, DSE, GGA, GLL, GNS, RMC, GSA & GSV

NMEA 0183-HS AIS Output (38400 baud)	VDM
--	-----

38400 Baud selected:

NMEA 0183-HS Input (38400 baud)	GGA, GLL, GNS, RMC, GSA, & GSV
NMEA 0183-HS Output (38400 baud)	DSC, DSE, GGA, GLL, GNS, RMC, GSA, GSV VDM

NMEA 0183-HS AIS Output (38400 baud)	VDM
--	-----

24.6 SCU-31 EXTERNAL GPS ANTENNA (Optional)

Receiver Channels	66 Channels
Sensitivity	Less than –147 dBm
Time to First Fix	1 minute typical (@Cold Start) 5 seconds typical (@ Hot Start)
Geodetic Datum	WGS84

24.7 DIMENSIONS

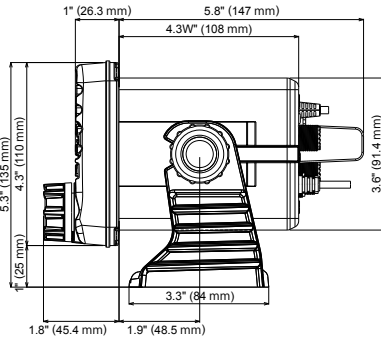
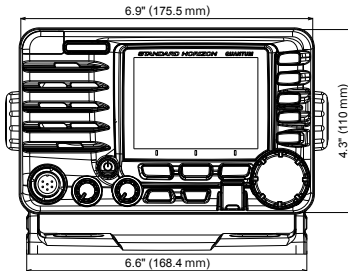
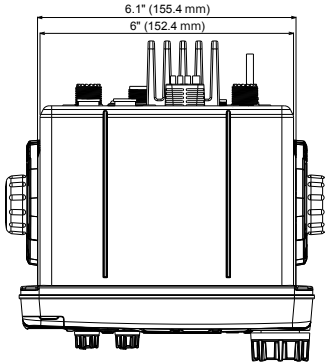
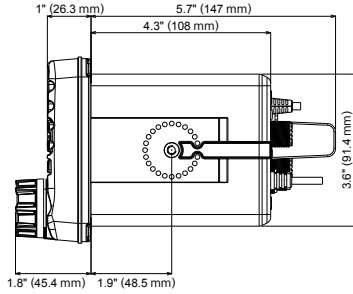
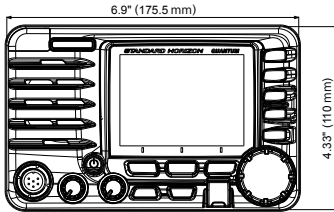
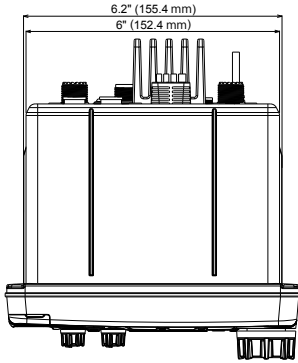

25 FCC RADIO LICENSE INFORMATION

Standard Horizon radios comply with the Federal Communication Commission (FCC) requirements that regulate the Maritime Radio Service.

25.1 STATION LICENSE

An FCC ship station license is no longer required for any vessel traveling in U.S. waters (except Hawaii) which is under 20 meters in length. However, any vessel required to carry a marine radio on an international voyage, carrying a HF single side band radiotelephone or marine satellite terminal is required to have a ship station license. FCC license forms, including applications for ship (605) and land station licenses can be downloaded via the Internet at <https://www.fcc.gov/fcc-form-605>. To obtain a form from the FCC, call (888) 225-5322.

25.2 RADIO CALL SIGN

Currently the FCC does not require recreational boaters to have a Ship Radio Station License. The USCG recommends the boats registration number and the state to be used when calling another vessel.

25.3 CANADIAN SHIP STATION LICENSING

You may need a license when traveling in Canada. If you do need a license contact their nearest field office or regional office or write:

**Industry Canada
Radio Regulatory Branch
Attn: DOSP
300 Slater Street
Ottawa, Ontario
Canada, KIA 0C8**

25.4 FCC / INDUSTRY CANADA INFORMATION

The following data pertaining to the transceiver is necessary to fill out the license application.

Type Acceptance FCC Part 80
Output Power..... 1 Watt (low) and 25 Watts (high)
Emission 16K0G3E, 16K0G2B
Frequency Range 156.025 to 163.275 MHz
FCC Type Number..... K6630593X3D
Industry Canada Type Approval 511B-30593X3D

26 FCC NOTICE

NOTICE

Unauthorized changes or modifications to this equipment may void compliance with FCC Rules. Any change or modification must be approved in writing by STANDARD HORIZON.

NOTICE

This equipment has been tested and found to comply with the limits for a Class B digital device, pursuant to Part 15 of the FCC Rules. These limits are designed to provide reasonable protection against harmful interference in a residential installation. This equipment generates, uses and can radiate radio frequency energy and, if not installed and used in accordance with the instructions, may cause harmful interference to radio communications. However, there is no guarantee that interference will not occur in a particular installation. If this equipment does cause harmful interference to radio or television reception, which can be determined by turning the equipment off and on, the user is encouraged to try to correct the interference by one or more of the following measures:

- Reorient or relocate the receiving antenna.
- Increase the separation between the equipment and receiver.
- Connect the equipment into an outlet on a circuit different from that to which the receiver is connected.
- Consult the dealer or an experienced radio/TV technician for help.

WARNING

It is a violation of the rules of the Federal Communications Commission to input an MMSI that has not been properly assigned to the end user, or to otherwise input any inaccurate data in this device.

THIS DEVICE COMPLIES WITH PART 15 OF THE FCC RULES. OPERATION IS SUBJECT TO THE FOLLOWING TWO CONDITIONS: (1) THIS DEVICE MAY NOT CAUSE HARMFUL INTERFERENCE, AND (2) THIS DEVICE MUST ACCEPT ANY INTERFERENCE RECEIVED, INCLUDING INTERFERENCE THAT MAY CAUSE UNDESIRE OPERATION.

Changes or modifications to this device not expressly approved by YAESU U.S.A. could void the User's authorization to operate this device.

This device complies with Industry Canada license-exempt RSS standard(s). Operation is subject to the following two conditions: (1) this device may not cause interference, and (2) this device must accept any interference, including interference that may cause undesired operation of the device.

Le présent appareil est conforme aux CNR d'Industrie Canada applicables aux appareils radio exempts de licence. L'exploitation est autorisée aux deux conditions suivantes : (1) l'appareil ne doit pas produire de brouillage, et (2) l'utilisateur de l'appareil doit accepter tout brouillage radioélectrique subi, même si le brouillage est susceptible d'en compromettre le fonctionnement.

Under Industry Canada regulations, this radio transmitter may only operate using an antenna of a type and maximum (or lesser) gain approved for the transmitter by Industry Canada. To reduce potential radio interference to other users, the antenna type and its gain should be so chosen that the equivalent isotropically radiated power (e.i.r.p.) is not more than that necessary for successful communication.

Conformément à la réglementation d'Industrie Canada, le présent émetteur radio peut fonctionner avec une antenne d'un type et d'un gain maximal (ou inférieur) approuvé pour l'émetteur par Industrie Canada. Dans le but de réduire les risques de brouillage radioélectrique à l'intention des autres utilisateurs, il faut choisir le type d'antenne et son gain de sorte que la puissance isotrope rayonnée équivalente (p.i.r.e.) ne dépasse pas l'intensité nécessaire à l'établissement d'une communication satisfaisante.

This radio transmitter (identify the device by certification number, or model number if Category II) has been approved by Industry Canada to operate with the antenna types listed below with the maximum permissible gain and required antenna impedance for each antenna type indicated. Antenna types not included in this list, having a gain greater than the maximum gain indicated for that type, are strictly prohibited for use with this device.

Le présent émetteur radio (identifier le dispositif par son numéro de certification ou son numéro de modèle s'il fait partie du matériel de catégorie I) a été approuvé par Industrie Canada pour fonctionner avec les types d'antenne énumérés ci-dessous et ayant un gain admissible maximal et l'impédance requise pour chaque type d'antenne. Les types d'antenne non inclus dans cette liste, ou dont le gain est supérieur au gain maximal indiqué, sont strictement interdits pour l'exploitation de l'émetteur. l'établissement d'une communication satisfaisante.

CAN ICES-3 (B) / NMB-3 (B)

cut here

TEMPLATE for the GX6000

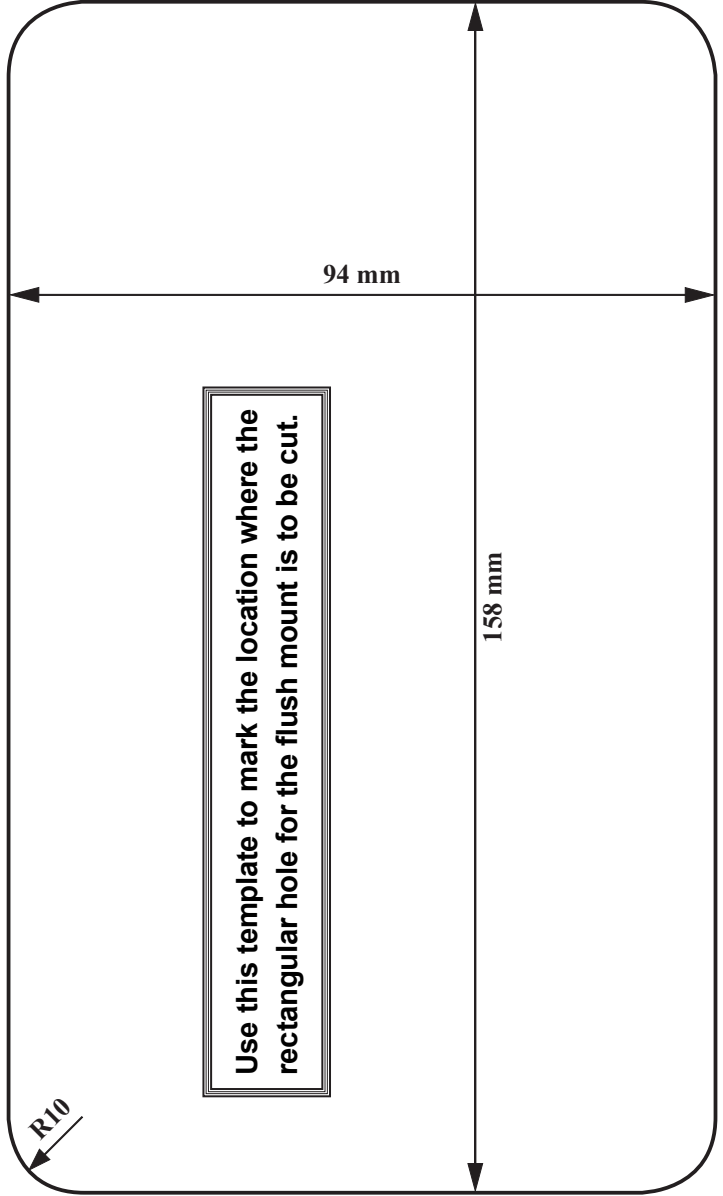

STANDARD HORIZON

Nothing takes to water like Standard Horizon

Copyright 2018
YAESU MUSEN CO., LTD.
All rights reserved.

No portion of this manual may be
reproduced without the permission of
YAESU MUSEN CO., LTD.

YAESU U.S.A.

6125 Phyllis Drive, Cypress, California 90630

www.standardhorizon.com