

USER MANUAL QUICK INSTALLATION GUIDE

MC900B

BLUETOOTH® 4-CHANNEL AMPLIFIER

BOSS[®]
AUDIO SYSTEMS

BOSS Audio Systems
3451 Lunar Court • Oxnard, CA 93030

www.bossaudio.com | 800.999.1236
Tech Support: www.bossaudio.com/support



iPod / iPhone are trademarks of Apple Inc. registered in the U.S. and other countries.
BOSS Audio Systems is not affiliated with Apple Inc.

0614 VER:1.0 EN



PRINTED IN CHINA

USER MANUAL QUICK INSTALLATION GUIDE

MC900B



BLUETOOTH® ENABLED
4-CHANNEL AMPLIFIER

BOSS[®]
AUDIO SYSTEMS

FEATURING
HANDLEBAR MOUNT REMOTE CONTROLLER

TABLE OF CONTENTS

BEFORE YOU START -----	2
<i>IMPORTANT SAFETY PRECAUTIONS</i>	
<i>INSTALLATION PRECAUTIONS</i>	
WIRE DIAGRAM -----	3
BEFORE INSTALLING THIS PRODUCT -----	4
<i>TECHNICAL SUPPORT</i>	
SUGGESTED MOUNTING METHODS -----	5
<i>FLUSH MOUNT</i>	
<i>SURFACE MOUNT</i>	
<i>HANDLEBAR MOUNT</i>	
GETTING STARTED -----	6
BLUETOOTH OPERATION -----	7
<i>PAIRING & DISCOVERING A NEW BLUETOOTH CONNECTION</i>	
<i>RECONNECTION</i>	
STREAMING MUSIC -----	9
<i>MULTIFUNCTION CONTROLLER BLUETOOTH OPERATION</i>	
AUX-INPUT -----	10
<i>AUX-IN OPERATION</i>	
<i>VOLUME CONTROL</i>	
INFORMATION TO THE USER -----	11
TROUBLE SHOOTING GUIDE -----	12
SPECIFICATIONS -----	12

All rights reserved. No part of this publication may be reproduced, distributed, or transmitted in any form or by any means, including photocopying, recording, or other electronic or mechanical methods, without the prior written permission of AVA Enterprises Inc.

Copyright © 2014 AVA Enterprises Inc.

BOSS[®]
AUDIO SYSTEMS

Thank you for purchasing this



MC900B Bluetooth Amplifier

Please read through these instructions carefully so you will know how to operate your model properly.

After you have finished reading the instructions, keep this document in a safe place for future reference.

THIS PACKAGE CONTAINS

1- MC900B Bluetooth 4-CH Amplifier



1- Multi-Function Controller

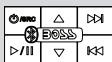

1- Flush Mount Bezel



1- Handlebar Mounting Bracket & Hardware Kit



1- Power Harness



1- User Manual



1- Warranty Card



The Bluetooth® word mark and logos are registered trademarks owned by Bluetooth SIG, Inc. and any use of such marks is under license.

Other trademarks and trade names are those of their respective owners.



BEFORE YOU START

IMPORTANT SAFETY PRECAUTIONS

- BE SURE TO OBSERVE THE FOLLOWING GUIDELINES:
 - Do not turn up the volume so high that you can't hear what's around you.
 - Use caution or temporarily discontinue use in potentially hazardous situations.
- Do not operate mobile video equipment while driving a motorized vehicle – safe driving and safety consideration of others should always be your highest priority.
- Set your volume control at a low setting, then slowly increase the sound until you can hear it comfortably without distortion, or ear discomfort.
- In the event you should notice smoke, strange noises or odor from this product, or any other abnormal signs, immediately turn off the power and consult your dealer or the nearest authorized **BOSS AUDIO** Service Center. Using this product in this condition may result in permanent damage to the system.

INSTALLATION PRECAUTIONS

WARNING - Always consult with a professional installer

- Do not attempt to install or service this product by yourself. Installation or servicing of this product by persons without professional training and experience in electronic equipment and motorized vehicle accessories may be dangerous and could expose you to the risk of electric shock, injury or other hazards
- Refer any repairs to a qualified **BOSS AUDIO SYSTEMS** Service Center
- The **MC900B** should be powered directly to a vehicles battery
- When wiring directly to the vehicles battery, be sure to disconnect the batteries negative terminal wire before starting any wiring procedures,if extending the main power wire, it is suggested that an optional fuse and fuse holder (not included) with minimum rating of **20 Amperes** be in-line with the positive battery terminal
- The ground cable length should not exceed 18-inches (See wiring diagram pg 4)
- The **MC900B** has a weather resistant design, it should not be submerged in or under water under any circumstances
- Use only the installation parts provided with the **MC900B**



CAUTION!! Using other mounting methods may void this warranty



WIRE DIAGRAM

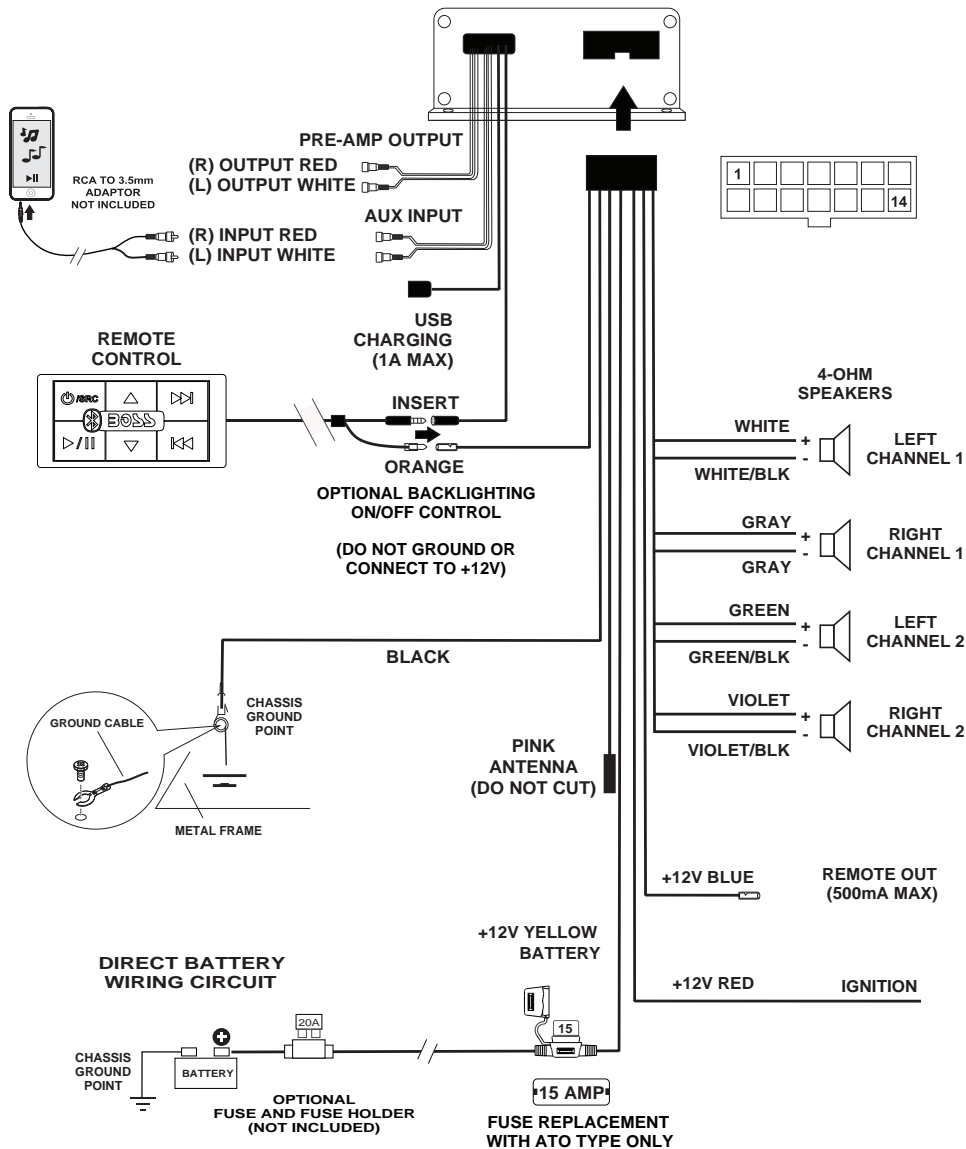

CAUTION!! Do not ground or short the PINK antenna wire

BEFORE INSTALLING THIS PRODUCT

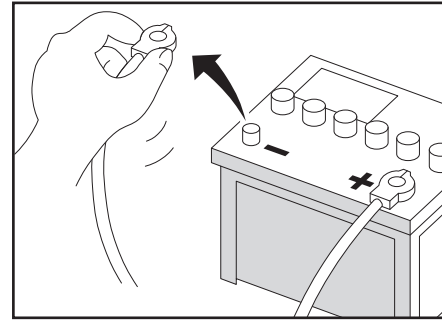

To avoid potential shorts in the electrical system, be sure to disconnect the (-) battery cable before installation. Use this unit with a 12-volt battery and negative grounding only. Failure to do so may result in a fire or malfunction.



When replacing the fuse, be sure to only use a fuse of the rating specified on this product.

To avoid short-circuiting, cover any disconnected leads with insulating tape. It is especially important to insulate any unused wires, which if left uncovered may cause a short circuit. When connecting other devices to this product, refer to the manual for the product to be connected. The black cable is ground, make sure to connect the ground wire first.

Ensure that the ground cable is properly connected to metal parts of the vehicles body frame or direct to the battery if your vehicle does not have a grounded chassis frame. The ground cable of this units power amp and a second powered system must be connected to the frame separately with different screws. If the screw for the ground wire loosens or falls out, it could result in fire or malfunction.

TECHNICAL SUPPORT

1-800-999-1236
www.bossaudio.com/support

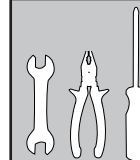

TOOLS NEEDED:

- Wrench and/or Pliers
- #2 Phillips screwdriver
- Crimp tool
- Electrical tape

SUGGESTED MOUNTING METHODS

The MC900B can be mounted in three different configurations:

1 FLUSH MOUNT

The flush mount quick mount bezel requires no screws and, use cutout dimensions: 3-3/16" W x 1-11/16" H (82mm x 43mm)

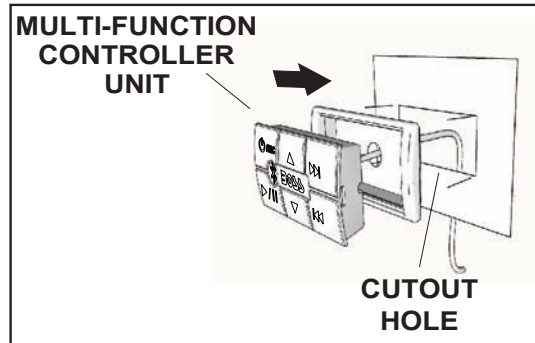

2 SURFACE MOUNT

The flush mount bezel has two recessed screw holes to facilitate the included two oval-head screws.

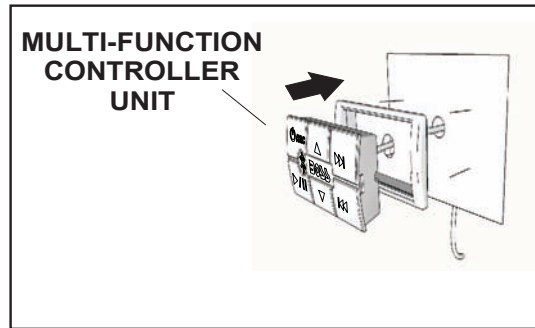

3 HANDLEBAR MOUNT

Use provided pan-head screws and stainless steel clamp, there are three mounting variations to secure the stainless steel clamp, try the best one for your application, securely tighten the stainless clamp to fit your application.

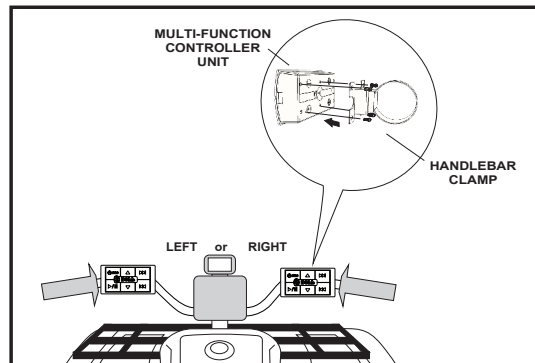

Tips: To release the *MC900B* controller from the mounting bezel, insert a small jewellers screwdriver into the left / right slots of the bezel.

GETTING STARTED

GETTING TO KNOW YOUR MC900B MULTIFUNCTION CONTROLLER (MFC)

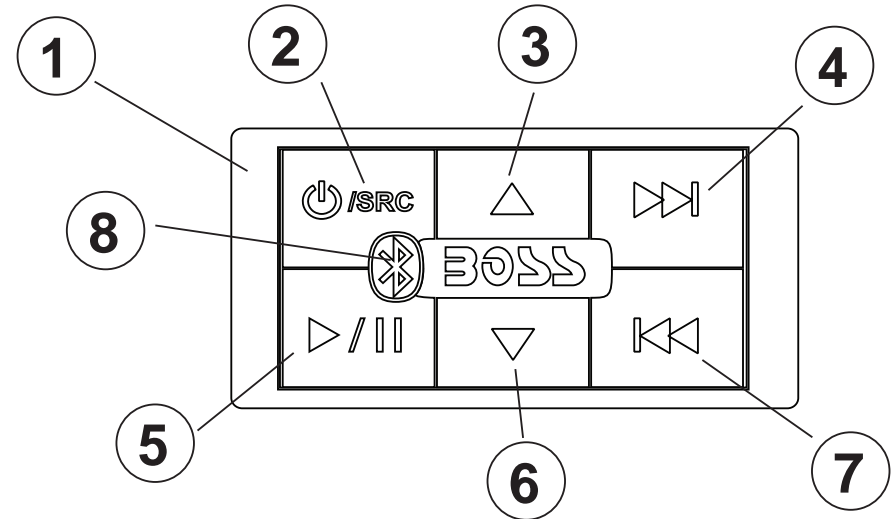

- 1 MFC - MULTIFUNCTION CONTROLLER
- 2 POWER / SOURCE - RED = AUX-IN MODE / BLUE = BT MODE
- 3 VOLUME UP
- 4 NEXT TRACK / FAST FORWARD
- 5 PLAY/PAUSE
- 6 VOLUME DOWN
- 7 PREVIOUS TRACK / FAST REWIND
- 8 BLUETOOTH PAIRING INDICATOR - BLUE COLOR

BLUETOOTH OPERATION

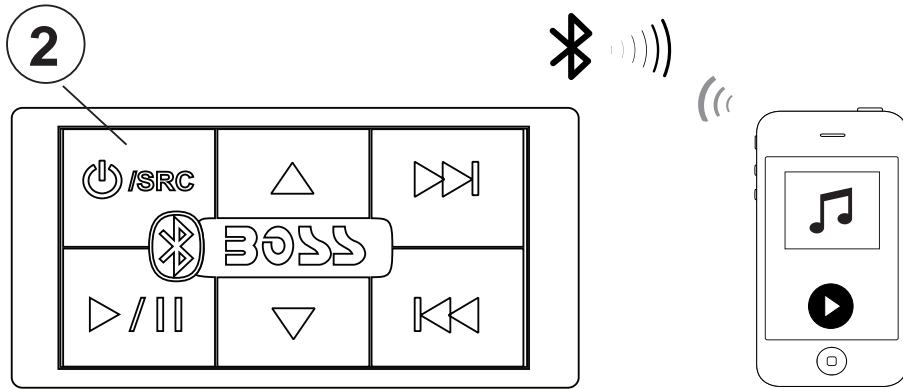

PAIRING & DISCOVERING A NEW BLUETOOTH CONNECTION

1) Power on the **MC900B** by pressing and holding down the **Power** **2** button for 2 seconds, the Bluetooth blue LED will start to flash, and a confirmation tone will be heard from the speakers signalling that the **MC900B** is now ready for Bluetooth pairing.

NOTE: You have 2 minutes before you must restart this procedure over again.

2) Now that the **MC900B** is in pairing mode:

ANDROID users:

- Go into the **Settings Menu** of your device
- Enter the **Bluetooth Menu** and press **SCAN**
- "**MC900B**" will now be display under **AVAILABLE DEVICES**
- If prompted, enter passcode: "**0000**"

iOS users:

- Go into the **Settings Menu** of your **iOS** device
- Enter the **Bluetooth Menu**
- "**MC900B**" will now be displayed
- If prompted, enter passcode: "**0000**"

3) If the **MC900B** is not seen, repeat the above steps to refresh the "**Device List**"

4) When the connection is successful you will hear a confirmation tone, you are now ready to stream music from your devices favorite media player to the **MC900B**



Tips:

To avoid battery exhaustion be sure to run the vehicles engine while using this product. Using this product without running the engine can drain the battery.

7

BOSS[®]
AUDIO SYSTEMS

BLUETOOTH OPERATION

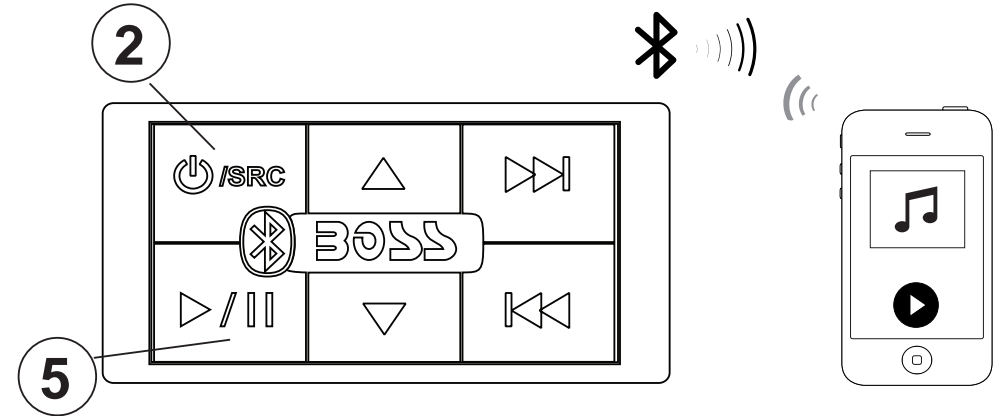

RECONNECTION

1) Power on the **MC900B** and your last paired device Bluetooth.

2) The unit will now automatically reconnect, and a confirmation tone will be heard from the speakers

3) If your device was previously paired with the **BOSS AUDIO MC900B**, but it wasn't the last paired device:

- Ensure no other devices are currently paired
- Enter the **Bluetooth Menu** on your device being paired
- "**MC900B**" will display under **AVAILABLE DEVICES**
- Choose the "**MC900B**" to reconnect

4) If the device is out of range from the **MC900B**, it will disconnect automatically:

- To reconnect once device is back in range, press the **Power** **2** button once
- The **MC900B** will now reconnect to the device, a confirmation tone will be heard from the speakers

CLEARING PREVIOUSLY PAIRED DEVICES MEMORY

1) Quick press the **POWER** **2** button **2X**, all **BLUE LED's** will start to flash

2) Press and hold the **PLAY/PAUSE** **5** button for 10 seconds, a confirmation tone from the speakers will be heard, the **LED's** will stop flashing, now only the **BT LED** will flash

3) **PAIR** a new device as described on **PG 8**

8

BOSS[®]
AUDIO SYSTEMS

STREAMING MUSIC

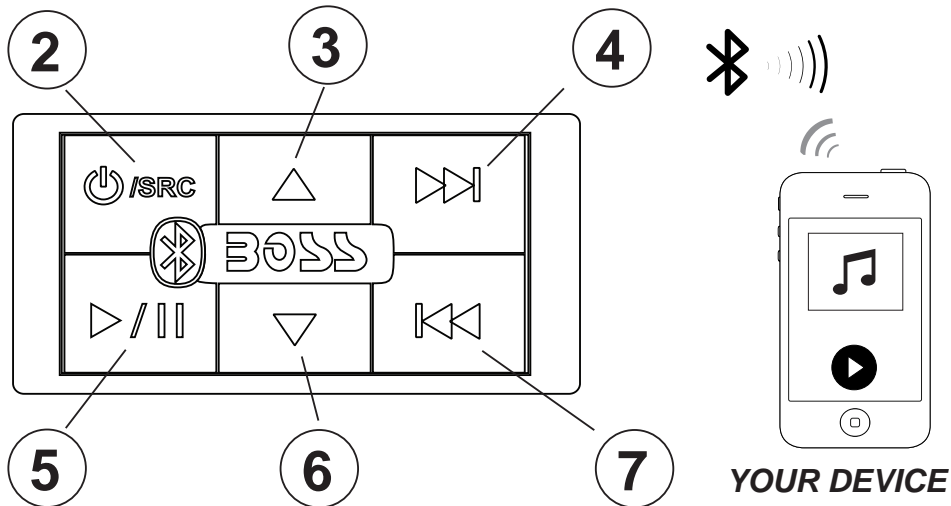

MULTIFUNCTION CONTROLLER BLUETOOTH OPERATION

- 1) Press the **5** **PLAY/PAUSE** once to start playing music or press the **PLAY** button from your device touch screen, press again to **PAUSE**
- 2) To skip songs or advance, press the **NEXT TRACK** **4** button, press and hold to **FAST FORWARD**
- 3) To select the previous song, press the **PREVIOUS TRACK** **7** button, press and hold to **FAST REWIND**

VOLUME CONTROL

- 1) To raise the **VOLUME** press **UP** **3** button
- 2) To lower the **VOLUME** press **DOWN** **6** button

 **Tips:** Turn the **BLUETOOTH** volume level on your device to it's 100% level

AUX-INPUT

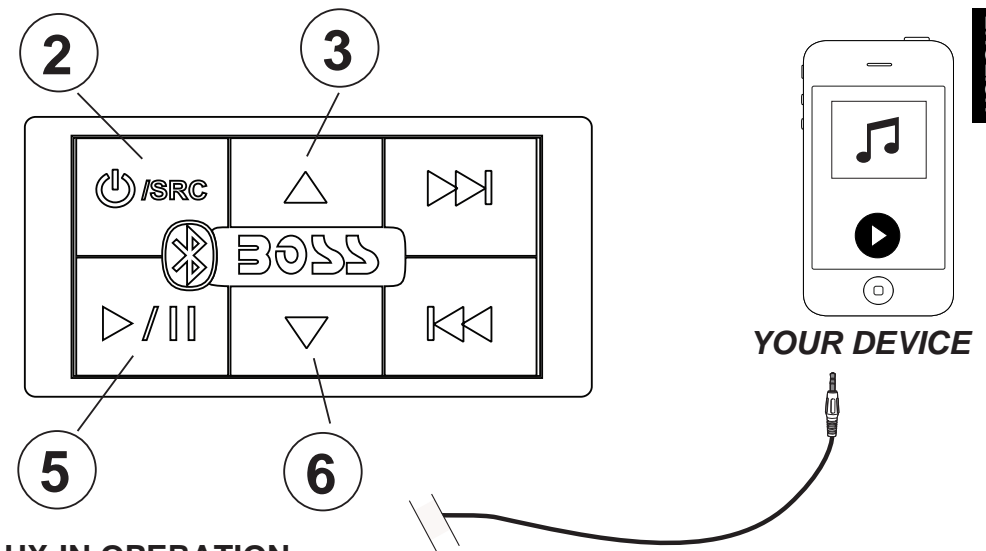

AUX-IN OPERATION

MC900B can play audio from any device that has a 3.5mm headphone audio jack.

- 1) Power on the **MC900B** by pressing and holding down the **POWER** **2** button for 2 seconds
- 2) Short press the **POWER** **2** button again once, the controller **LED** lighting will change to **RED**, indicating the system is in **AUX-IN** mode
- 3) **Bluetooth** devices will remain paired even in **AUX-IN MODE**
- 4) Connect the integrated **RCA AUX-IN** cable on the amplifier to a 3.5mm adaptor (3.5mm to RCA adaptor is not included)
- 5) Route the audio wires back to a convenient stowage place, secure your device.

VOLUME CONTROL

- 1) To raise the **VOLUME** press **UP** **3** button
- 2) To lower the **VOLUME** press **DOWN** **6** button
- 3) To **MUTE / UN-MUTE** the **VOLUME** press **PLAY/PAUSE** **5** button

 **Tips:** Turn the **HEADPHONE** volume level on your device to it's 100% level

INFORMATION TO THE USER

FCC COMPLIANCE STATEMENT

This device complies with part 15 of the FCC Rules. Operation is subject to the following two conditions:

- (1) this device may not cause interference, and
- (2) this device must accept any interference, including interference that may cause undesired operation of this device.

This transmitter must not be co-located or operated in conjunction with any other antenna or transmitter. The Bluetooth antenna cannot be removed (or replaced) by user. This equipment complies with FCC/ IC radiation exposure limits set forth for an uncontrolled environment and meets the FCC radio frequency (RF) Exposure Guidelines and RSS-102 of the IC radio frequency (RF) Exposure rules. This equipment has very low levels of RF energy that it deemed to comply without maximum permissive exposure evaluation (MPE). But it is desirable that it should be installed and operated keeping the radiator at least 20 cm or more away from person's body (excluding extremities: hands, wrists, feet and ankles). Alteration or modifications carried out without appropriate authorization may invalidate the user's right to operate the equipment.

NOTE: This equipment has been tested and found to comply with the limits for a Class B digital device, pursuant to Part 15 of the FCC Rules. These limits are designed to provide reasonable protection against harmful interference in a residential installation. This equipment generates, uses and can radiate radio frequency energy and, if not installed and used in accordance with the instructions, may cause harmful interference to radio communications. However, there is no guarantee that interference will not occur in a particular installation. If this equipment does cause harmful interference to radio or television reception, which can be determined by turning the equipment off and on, the user is encouraged to try to correct the interference by one or more of the following measures:

- Relocate or reorient the receiving antenna.
- Increase the separation between the equipment and receiver.
- Connect the equipment into an outlet on a circuit different from that to which the receiver is connected.
- Consult the dealer or an experienced radio/TV technician for help.



CAUTION!!
ADJUSTMENT OR ALTERATIONS OF THIS DEVICE MAY RESULT
IN HAZARDOUS RADIATION EXPOSURE.

11

BOSS[®]
AUDIO SYSTEMS

TROUBLE SHOOTING GUIDE

TROUBLE	CAUSE	SOLUTION
Unit will not turn on	The fuse is blown	Check / replace the fuse
	Ignition not engaged	Turn ignition to on position
No sound is heard	Blown speaker	Replace faulty speaker
	Volume is low / muted	Press the volume level up
	Device is paused or muted	Check your devices playing / volume status
Cannot pair Bluetooth	The Bluetooth function of the device is not enabled	Refer to the user manual of the device for how to enable the Bluetooth function
	The MC900B memory is full	Follow how to clear the memory on PG 8
The audio quality is poor after connection with a Bluetooth enabled device	The Bluetooth reception is poor	Move the device closer to the audio system or remove any obstacle between the device and the systems antenna
Unit has become unresponsive	Power glitch or interference	Disconnect power for 10 seconds to reset

SPECIFICATIONS

BLUETOOTH

- BT: 4.0
- BT Range: 33Ft / 10M (Class 2)
- BT Profiles: A2DP

AMPLIFIER

- Channels: 4
- **MAX** Continuous Output: 500W (All channels driven)
- **PEAK** Power Rating:
- 4Ω: 125W /channel
- **RMS** Total Power Output: 150W
- Class: AB
- Frequency response: 20-25kHz
- 4Ω stable
- Input impedance: 22k Ohm

CHASSIS

- Chassis Dimensions HxDxW :
1.75"x 7.8" x 3.8" / 44.5mm x 198mm x 96.5mm
- Controller Dimensions HxDxW:
0.81"x 3.75" x 1.85" / 20.5mm x 95.2mm x 47mm
- Controller cable length: 20ft / 6m
- Backlight illumination control wire
- Quick connect Molex power harness

GENERAL

- Power source: 14.4VDC (10.8V ~ 16V allowable)
- Grounding System: Negative type
- Maximum Current Consumption: 15A
- 3-way protection circuitry (thermal, overload, and speaker short protection)
- USB output voltage: 5VDC @ 1A
- Unit Weight: 2.08lbs / 0.94kg
- Storage Temperature: 5°F to 113°F / -15°C to 45°C
- Operation Temperature: 14°F to 104°F / -10°C to 40°C
- Replacement Fuse: 15A

(Replace with ATO Fuse Type Only)

SPECIFICATIONS SUBJECT TO CHANGE WITHOUT NOTICE

BOSS[®]
AUDIO SYSTEMS

12