

IRIS402/740

Marine Network IP Camera - 2MP

INSTALLATION & OPERATION GUIDE

Important Notices. Read before Use:

This instruction manual is intended for administrators and users of the IRIS402 and 740 IP Cameras, including instructions for using and managing the camera on your network. The use of video surveillance devices can be prohibited by laws that vary from country to country. It is the user's responsibility to ensure that the operation of such devices is legal before installing this unit for surveillance purposes.

Before installing the IP Camera, please read and follow all the safety and operating instructions to avoid any damages caused by faulty assembly and installation. The user must adhere to all the warnings on the product and in this manual.

Liability

Every reasonable care has been taken in the preparation of this instruction manual. Iris can not be held responsible for any technical or typographical errors and reserves the right to make alterations to the product and manuals without prior notice. Iris makes no warranty of any kind with regard to the material contained within this manual, including, but not limited to, the implied warranties of merchantability and fitness for a particular purpose. The user should verify the relevant information is current and complete before placing orders. All products are sold subject to Iris' terms and conditions of sale at the time of order acknowledgement.

Iris shall not be liable nor responsible for the applications and resale of its products or bundled software with statements different from or beyond the specification/parameters stated by Iris. Iris is under no obligation to provide any further technical support service or product/software alteration beyond Iris' representation.

CE/FCC Statement (EMC)

This equipment has been tested and found to comply with the limits for a Class A digital device, pursuant to Part 15 of the FCC Rules which are designed to provide reasonable protection against such interference when the equipment is operated in a commercial environment. If the equipment is not installed and used in accordance with the instruction, it generates, uses, and can radiate radio frequency energy which may cause harmful interference to radio communications. Operation of this equipment in a residential area is likely to cause interference, in which case the user at his/her own expense will be required to take whatever measures may be required to correct the interference.

Overview

The IRIS402 Network Marine Camera from Iris Innovations packs state of the art Internet Protocol CCTV technology into an incredibly compact, robust housing that measures only 10cm in length and 6cm in diameter. With an ingress protection rating of IP67, and manufactured from high quality materials, the 402 is perfect for operation in harsh marine environments. Ideal for on board surveillance, situational awareness and for Sports Fishing applications.

Key features of the 402 camera include:

- 📹 High Definition 2 Mega Pixel Image Resolution
- 📹 'True' Day/Night Operation with Mechanical IR cut out filter for optimized night operation
- 📹 Built-in Infra Red Illuminators. Working IR Distance of 10 meters.
- 📹 Up to 30fps @ 1080p Full HD (1920 x 1080).
- 📹 Supports H.264, MPEG-4 and MJPEG triple codec compression with dual streams
- 📹 Secondary 1VP~P Composite Video output for 'Non IP" operation (optional).
- 📹 Wide Dynamic Range Image Processing
- 📹 IP67 Waterproof Rating
- 📹 Built-in Micro SD card slot for local storage
- 📹 PoE 802.3af compliant, and DC 12V Power (optional).
- 📹 Supports ONVIF standard to ensure reliable interoperability

The IRIS740 'Barracuda' camera packs the same network camera engine into a solid, through-hull housing to deliver beautifully crisp, high resolution underwater footage. As well as the features above, the 740 has the following features:

- 📹 Aluminium Bronze Bezel
- 📹 Hard Anodized Aluminium
- 📹 IP68 Waterproof Design
- 📹 Waterproof RJ45 Connector
- 📹 Housing Dimensions: 118mmø Bezel. Shaft Length: 120mm. Shaft Diameter: 89mmø
- 📹 Hole Cut-Out: 90mm (3.54")
- 📹 Weight: 1.8Kg

About IP Cameras

An IP camera usually combines a standard CCTV type camera with additional circuitry and software to convert the signal from and communications to the camera into a digital format that can be accessed via the internet or an ethernet based network.

The circuitry within the camera literally hosts it's own website. IP cameras are simply CCTV cameras with integrated video web servers.

Package Contents:

Contents may vary depending on model and specific OEM applications.

1. Marine Network Camera (IRIS402 / IRIS740)
2. Waterproof CAT5e Ethernet Cable
3. User Guide

Please Note: PoE injectors are not supplied with the camera and must be ordered separately.

Installation: IRIS402

Warning: Installation of this product must only be carried out by a marine electronics professional or competent person. Failure to observe these installation guidelines and good electrical practices could result in fatal damage to the product, other on board equipment and personal injury. Observe electrical codes and practices of the region in which the device is being installed.

When installing on board, it is essential to observe electrical safety precautions associated with the installation and operation of DC powered electronic equipment in and around water. Ensure the waterproof integrity of the camera, cables and connection of the device are never breached or compromised. Always power the device from an appropriately rated fuse board or distribution panel.

DC Power Supply (Optional)

The IP2 requires a 12V DC supply. Although the camera draws much less current during operation, allow for a 2A peak surge during power up. Always use suitably rated cable to deliver power to the camera.

Power over Ethernet (PoE) (Standard)

As standard, power to the camera is delivered via the CAT5e STP ethernet connection, and injected into the PoE junction box (not included). The PoE junction box requires an 8~36VDC input. Although the camera draws much less current during operation, allow for a 2A peak surge during power up. Always use suitably rated cable to deliver power to the camera. Please note, the PoE junction box is not waterproof and must be installed away from water, moisture and excessive heat sources. The 402/740 can also be powered from a PoE ethernet hub (not supplied).

Cabling

The 402/740 is supplied as standard with a 20 meter, PUVC CAT5e STP waterproof cable. At one end is an IP68 rated waterproof RJ45 connector that plugs into the camera. The other end of the cable has intentionally been left bare in order to reduce the size of the entry hole required into the side of the vessel.

The outside diameter of the cat 5 cable is 6mm. Once the cable has been routed through the side of the vessel and into the boat it will be necessary to fit an STP RJ45 jack. A STP RJ45 connector is supplied.

Use STP CAT5e cable to connect the PoE injector to the server, computer or hub.

Brackets

As the IRIS402 can be used for different purposes, brackets are not included. Please contact your Iris dealer to purchase the bracket suitable for your requirements.

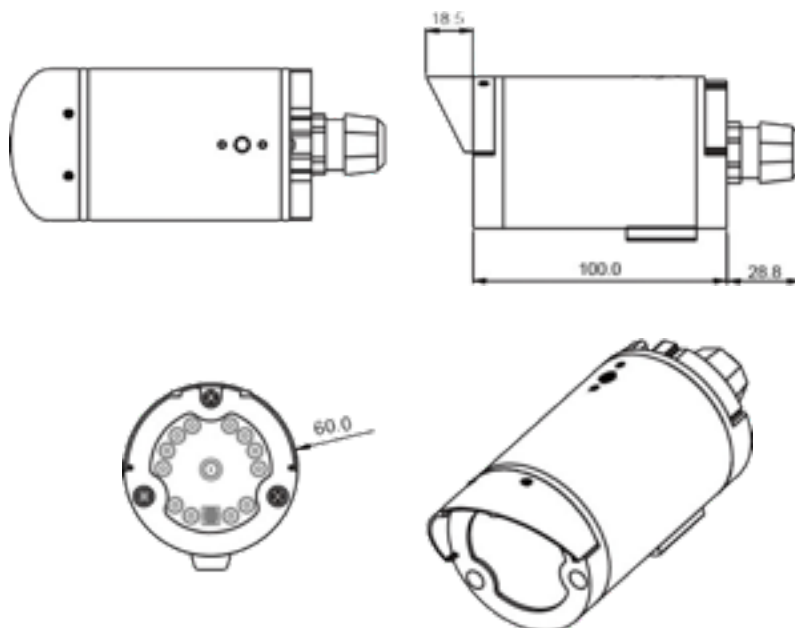

Installation: IRIS740

WARNING:

Installation of the IRIS740 necessitates a hole being cut into the structure of the vessel. Although guidelines are provided below, the responsibility to ensure the camera is installed correctly and is sealed sufficiently to prevent water ingress belongs to the installer, who must be suitably competent. Iris Innovations Limited and Iris Innovations USA Corporation accept no liability whatsoever for issues that may arise as the result of improper or sub standard installation that results in damage caused directly or indirectly as a result of leakage.

IMPORTANT:

- 🔊 Always ensure that the vessel's power source and battery are disconnected prior to installation
- 🔊 Ensure a suitable fuse or circuit breaker are used. Iris recommend a 3A fuse.
- 🔊 Prior to installation, ensure there is sufficient space within the vessel to accommodate the camera, taking into consideration room to tighten the cameras lock nut and facilitate access to connect and disconnect the cable.
- 🔊 Although the camera housing and rear connector are waterproof, the PoE injector may not be. Ensure this is installed well away from any moisture or direct heat sources.

Procedure:

- 1) Locate the camera as desired, taking into consideration internal or external obstacles that may affect the performance of the camera or inhibit the installation.
- 2) The camera should be positioned on a flat surface. Ensure the external surface of the hull (or transom) are even and parallel. It may be necessary to sand or grind the surface.
- 3) Once the installation area is prepared, drill a 90mm (3.54") hole using a suitable pilot hole and hole saw.
- 4) Ensure the inner hull surface is sealed to prevent water intrusion into the hull before the camera is secured in place.
- 5) Ensure that the hull surface is free from dirt, grease and debris. Remove anti-foul from the hull surface where the camera bezel will sit.
- 6) Use a suitable marine adhesive sealant (3M 4200 for example) to apply a liberal bead of sealant around the entire circumference of the back side of the bronze bezel. A channel is machined into the back of the bezel - ensure this is completely filled with sealant.
- 7) Apply a bead of sealant around the edge of the 90mm (3.54") hole.
- 8) Carefully slide the camera into the hole, ensure the orientation of the camera is as required. The camera is shipped with a removable stick-on arrow to indicate the 'top' of the cameras field of view.
- 9) From inside the vessel, slide the rubber spacer rings over the camera shaft as required to ensure the lock nut will provide a suitably tight fixing. Two rings are supplied.
- 10) Screw the lock nut in place and hand tighten. Do not lock fully in place at this stage.
- 11) Connect the waterproof RJ45 plug into the back of the camera. Details on connecting to the network via a PoE injector are listed above.
- 12) Ensure the camera orientation is as desired. Make any changes to the cameras orientation now before the sealant cures and the lock nut is fully tightened.

Procedure (Continued...):

- 13) Disconnect the cable from the camera.
- 14) Follow the sealant manufacturers instructions on curing time before fully tightening the camera lock nut.
- 15) From inside the vessel, apply another bead of sealant fully around the circumference of the camera shaft.
- 16) Allow the sealant to fully cure before putting the boat back into the water.
- 17) Connect the waterproof CAT5 cable to the camera connector, ensuring the connector sits true in the receptacle and the connector lock-nut is fully tightened without cross threading.
- 18) Now connect the cable to your network and follow the setup instructions below.

DO NOT LAUNCH THE VESSEL UNLESS THE SEALANT IS FULLY CURED IN ACCORDANCE WITH THE SEALANT MANUFACTURERS INSTRUCTIONS AND YOU ARE SATISFIED THERE ARE NO LEAKS.

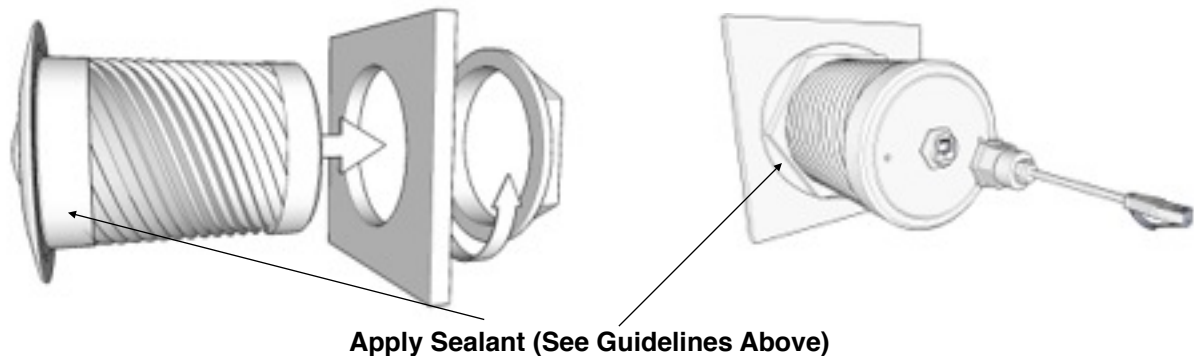

Setup

1. Connect the camera to a powered Ethernet source so that the unit is connected directly or indirectly to a DHCP server.
2. The camera will adopt an I.P. address provided by the DHCP server, and will initially be displayed on the host as a new attached device with name “-“ (Please refer to Router/DHCP server manual for relevant instructions on performing this).
3. Once this is connected, new I.P and network details can be set via the Network setup page.
4. In the event of there being problems connecting the camera to your network, please contact your network administrator or IP specialist quoting the cameras individual MAC address which can be found printed on the carton label.

By default the camera is set to DHCP. Once connected directly or via your network to a DHCP router or server, the camera should automatically assume the address it has been assigned.

A software discovery tool is provided with the camera to assist camera discovery and assigning addresses if necessary. The tool is an executable program which can be copied onto your computer and run directly. Once opened, the discovery tool can be set to SCAN the network for any connected IRIS402 or 740 cameras. It does this by broadcasting specific information across the network which only an Iris camera will respond to. In doing so, the camera will return it's current IP address. The tool can be used to assign a new address if required.

Accessing the Camera

Viewing Live Video

Once the camera has been correctly addressed and set up on your network, live video can be viewed in three ways:

- Internet Browser: Simply launch your internet browser and enter the IP address of the camera.
- RTSP Player: The live video from the camera can be played with RTSP players such as VLC or QuickTime. The camera supports two simultaneous video streams (See Video & Audio / Video Settings). To gain access to the camera for each video stream, the RTSP URL will be required. The default paths for the 2 streams are 'stream1' and 'stream2'. The URL format should be input as below:

Stream1: `rtsp://Camera_IP/stream1`

Stream2: `rtsp://Camera_IP/stream2`

The example below is the live video displayed using QuickTime Player:

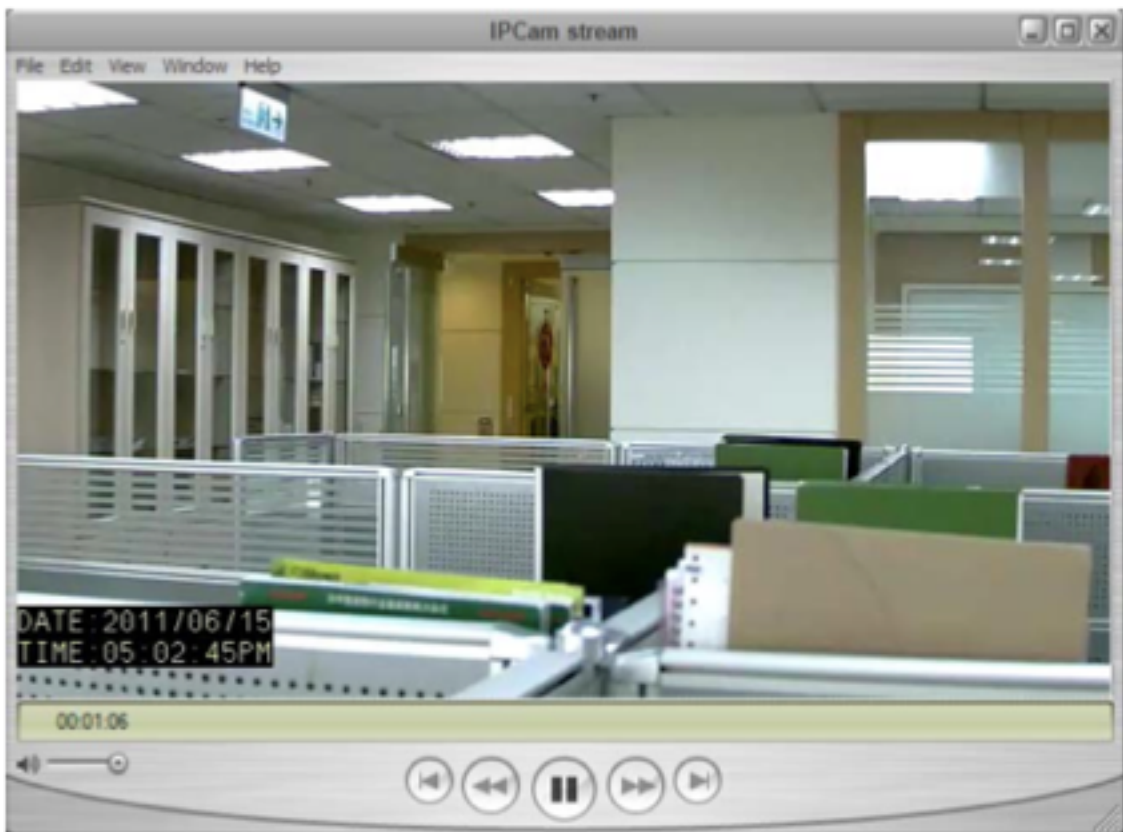
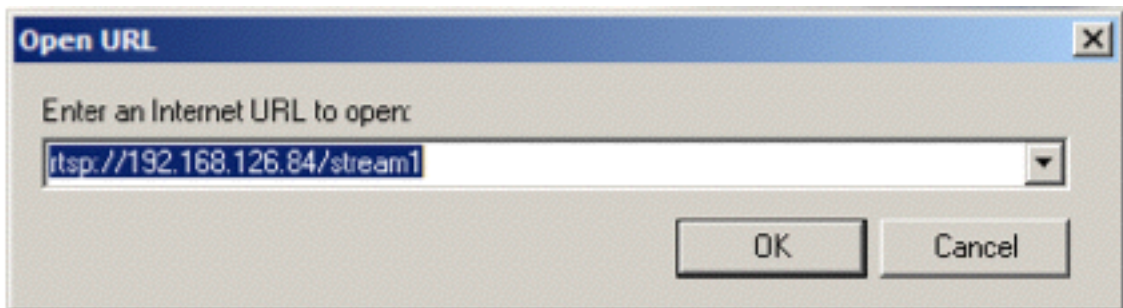

Accessing the Camera (Continued...)

- 💡 NVR / CMS Software: The Iris IP2 camera is an ONVIF compatible product. Most ONVIF compatible NVR / CMS software can retrieve the video from the camera for both live view and recording. For further details on compatibility and operation, please contact the specific software vendors.

The Live View Page

The screen-grab below details the front page of the IRIS402 / 740 camera website.

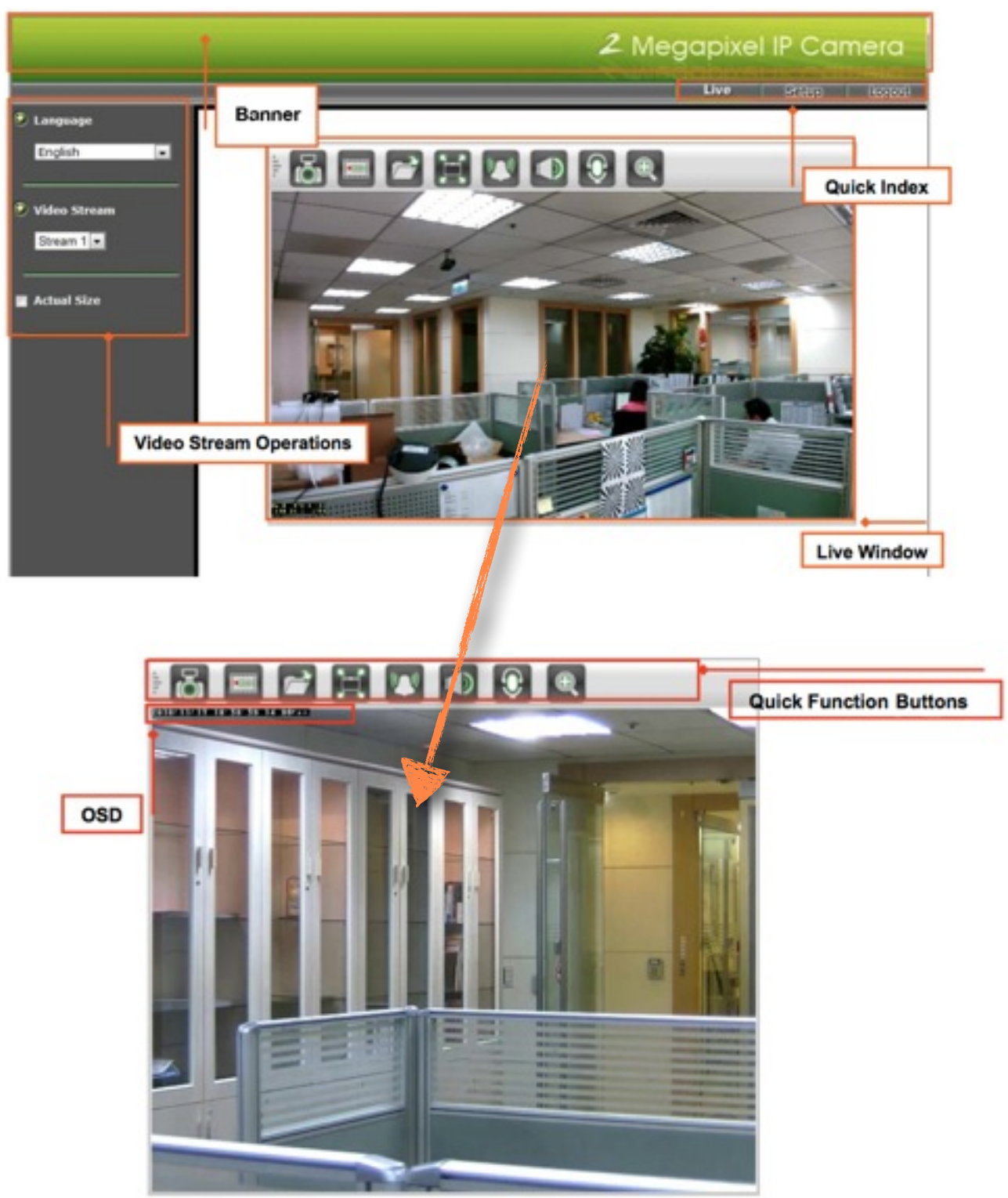

Quick Function Buttons Explained.



Snapshot:
Press the button to capture an image photo



Record:
Press the button to start recording.
Press again to stop recording.



Record Path:
Set up the file path into which video clips and snapshots can be stored.



Full Screen:
Press to enter Full Screen Display mode.
Press the ESC key to return to normal view.



Manual Trigger:
Press to trigger an 'Event'. (See Event Management for further details).



Listen:
Toggle to enable / disable Audio from the camera (on Audio Enabled models only).



Talk:
Select to enable / disable speech to the camera (on Audio Enabled models only).



Digital Zoom:
Toggle the Digital Zoom function.

Video Stream Operations Explained.

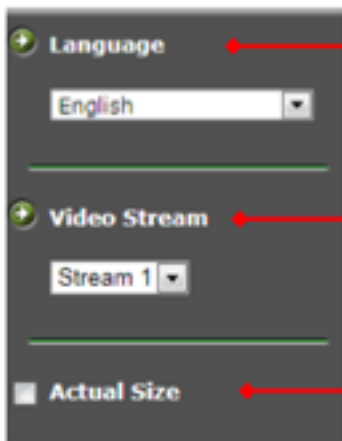

Language selection for the WEB UI

Select video stream for displaying on live video window

Display the video in actual (configured) size or digital (scaled) size

Video & Audio:

This section describes how to configure the video streaming of the device and the related camera image configurations. Users with Administrator or Operator authority (see *System → User Management*) are able to set these configurations.

Click on 'Setup' to enter the configuration pages:

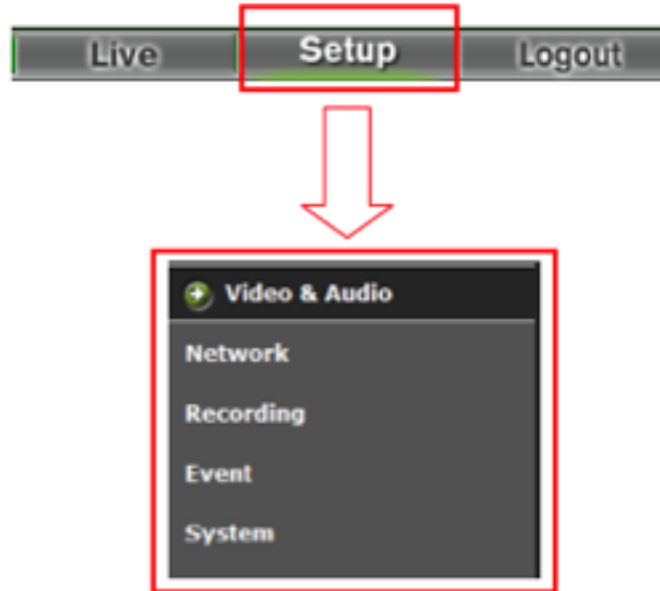

There are three sub settings under the 'Audio & Video' Tag:

- 👤 Camera Settings (With sub-headings, Image Settings, Day/Night & Advanced Settings)
- 👤 Video Settings
- 👤 Audio Settings

Camera Settings:

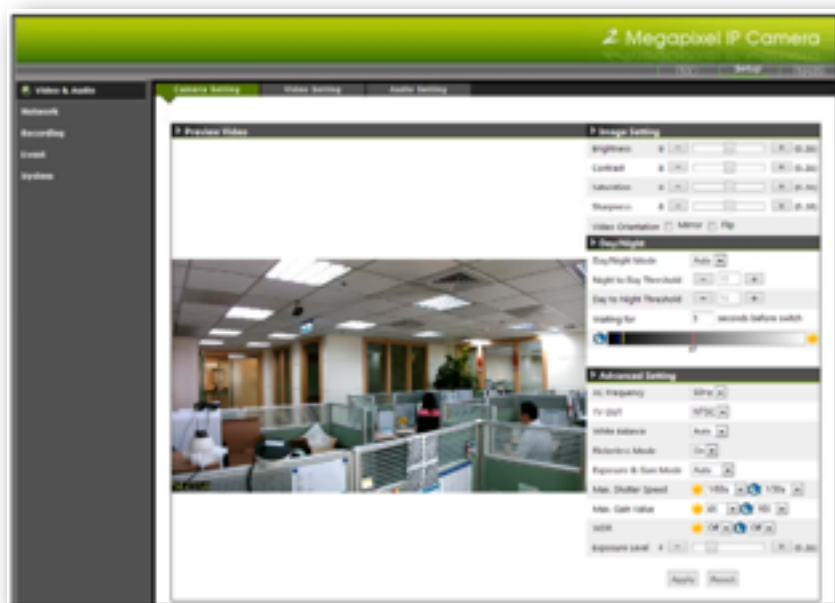

Image Settings:

- Brightness:** The luminance of image view. Default value is 8; adjustable from 0 to 16.
- Contrast:** The ratio of luminance of white to black. Default value is 8; adjustable from 0 to 16.
- Saturation:** Depth of a colour in relation to it's brightness. Default value is 8, adjustable from 0 to 16.
- Sharpness:** Determines the degree of edge contrast of objects within the image. Default value is 8, adjustable from 0 to 16.

Video Orientation:

Changes the horizon (Mirror) and vertical (Flip) orientation of the image.

Day / Night :

Day night mode is used to switch the video images for Day (plenty of ambient light), or Night (low ambient light) optimisation. The default setting is Auto in which the camera will switch to Day or Night operation depending on the intensity of ambient light in the scene. The Day / Night modes perform two actions; switching the mechanical IR filter on or off whilst also switching the image hue from Colour (Day) to Monochrome (Night).

In day mode, the IR filter is switched in to avoid the image sensor from receiving the infrared, thus the true colour image is provided. When camera enters night mode, IR filter is switched off to allow IR illuminations going into the sensor, thus increasing the images light level. The image colour is switched to B/W (Mono mode).

Advanced Settings:

AC Frequency: Anti-flicker setting for environment with fluorescent light sources, image sensor needs to set the frequency of light (power) source. For instance, the power frequency is 50Hz for most European countries, while 60Hz is typically for US. This setting is therefore regionally different.

White Balance: Usually set to Auto. Manual configuration allows adjustment of colour temperature in accordance with the lighting condition of the scene, varying from blue to red.

IRIS Mode: Enable auto IRIS mode when DC-Iris lens is installed. System will enable auto exposure and gain control (default setting is Auto).

Flicker-less Mode: flickering can also effect exposure levels. Set "Flickerless" Mode "On" to fix the maximum shutter speed (auto exposure control), eliminating flicker.

Exposure & Gain Mode: Selectable between auto and manual mode. This selection defines control over a range (manual) or a fixed value (auto), according to the following two items (Shutter Speed and Gain Value). The configurations will be limited at selected maximum rates when AUTO mode is on.

Max. Shutter Speed: Sets exposure time. Higher shutter speed is normally applied under strong light conditions, so the image won't be overexposure. Lower shutter speed, on the other hand maintains image luminance in low light environment.

Max. Gain Value: the amplification factor for the incoming light. Increasing the gain value provides a brighter image, but the noises may also be increased.

WDR: Wide Dynamic Range. Switches dynamic processing of image under high contrast conditions.

Exposure Level: Adjust Exposure level for a target exposure time that is the amount of light allowed for the image sensor.

Note:

The "**Shutter Speed**", "**Gain Value**" and "**WDR**" can be configured for daytime and nighttime. The configurations will be applied according to the current status of "**Day/Night Mode**".

Advanced Settings (continued):

The Advanced Settings panel:

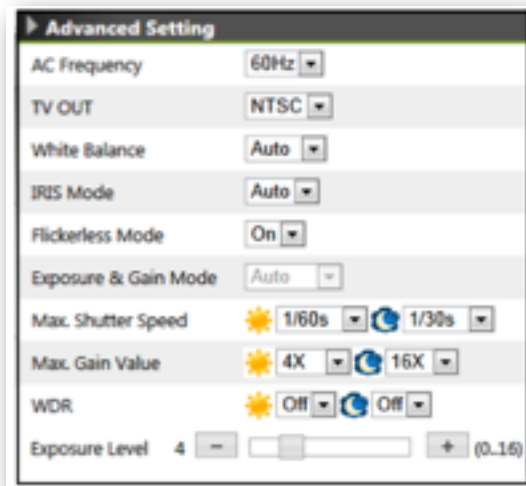

Video Settings:

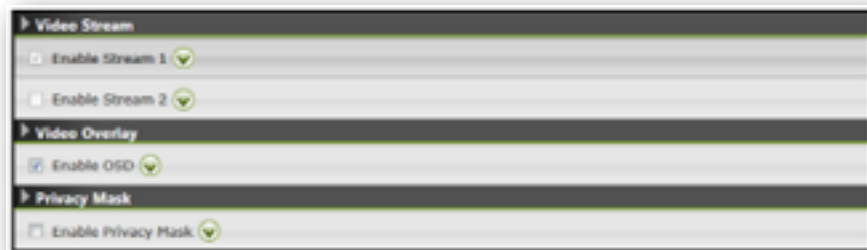

Video Stream:

This tab provides detailed stream configurations. These settings can affect video size, quality. The maximum transmission performance can be expected under the condition of full network bandwidth.

The camera supports up to 2 video streams. Each stream can be configured with following items.

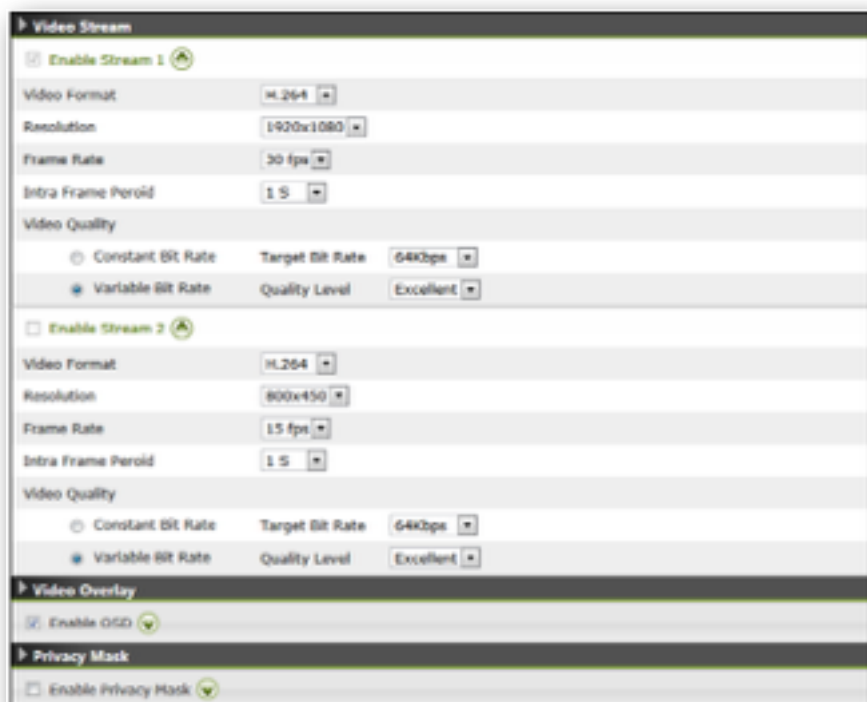

Video Format:

H.264, MPEG4 and MJPEG are available for the selection. The demand of bandwidth and storage requirement differs from the selection of video format. In the request of same video quality, H.264 contributes to less bandwidth and storage requirement, which can be more efficient than MPEG4 or MJPEG.

Resolution:

The resolution here describes an image size counted in width by height, e.g. 1280x720, referring to pixel resolution.

The available resolutions for Stream 1 and Stream 2 are listed in the following table:

Resolution	Stream 1	Stream 2
1920 x 1080	V	-
1280 x 720	V	-
800 x 450	V	V
640 x 360	V	V
320 x 180	V	V

"V": available
 "-": not available

Frame Rate:

Represents the number of frames that are displayed per second. The higher the frame rate is the better / smoother the video stream can be obtained. However, there is a trade-off for with higher network bandwidth and storage requirements depending on the frame rate. The higher the frame rate, the more bandwidth and storage required and vice versa.

Intra Frame Period:

This is applied only in MPEG4 / H.264 formats, in which the video stream is composed of I- frames (full image information) and P-frames (motion-compensated difference information).

This setting configures the time period between 2 I-frames. The shorter period means the higher frequency of I-frame and improved video handling, but also a higher bit rate.

Video Quality:

There are two types of bit-rate controls for video quality adjustment, Constant Bit Rate (CBR) and Variable Bit Rate (VBR).

CBR settings are used to limit a fixed rate of data transfer. However, VBR can be utilized when network bandwidth is less of an issue.

Note: CBR is not applicable in MJPEG modes.

Video Overlay:

The camera supports stamping text information on the video images. The options of the date/time string or/ and a line of text message (e.g. camera name or location) are available for displaying on the images.

Privacy Mask:

Privacy Mask can block out specific areas from view. The blocked areas will not be seen in both live view or recorded video clips. A total of 8 profiles can be allocated to the list.

To create Privacy Mask, simply input Privacy Mask Name and click "Add New" button and then apply it to complete the addition.

Privacy Mask (continued):

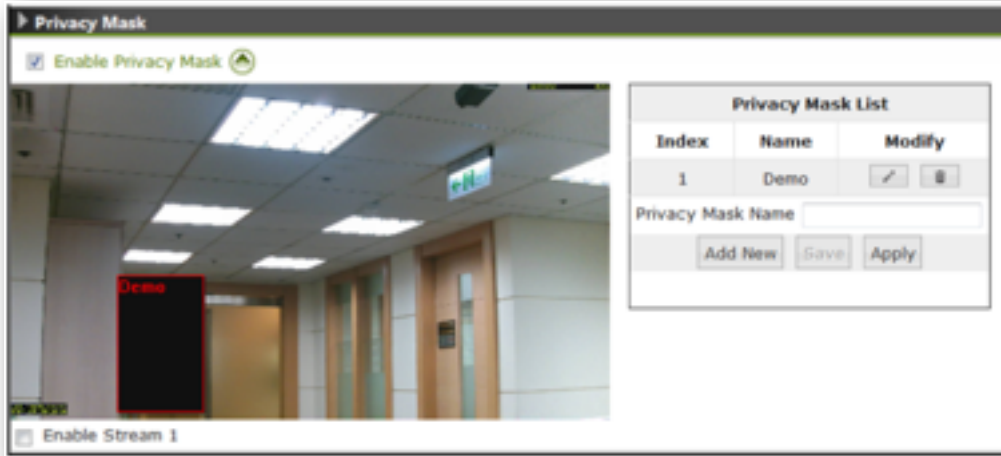

Privacy Mask Window.

Audio Settings:

Check the “Enable Audio” checkbox to enable video streaming with audio. The audio encoding supports G.711 ulaw. For Audio Input Setting, there are two types of input sources: Internal / External Microphone. The default setting will be internal microphone.

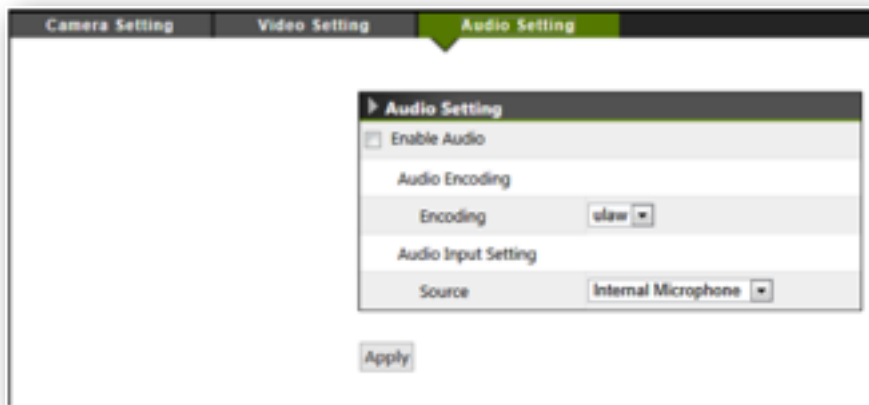



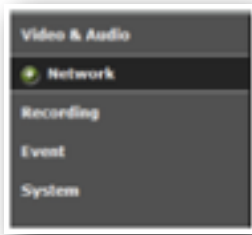

Network Configuration:

The IP Camera acts as a network device. It allows users to configure network functionalities based on applications. This section will describe the network configurations. Fundamentally, for instance, the IP assignment of the device can be done via DHCP server, static IP option or PPPoE to obtain IP from the service provider.



There are six subdirectories within the Network Configuration category:

-  Network Type
-  Network Connectivity
-  Quality Service
-  Access Port
-  Access IP Filter

Network Type:



Network Type:

There are 3 ways to configure IP address for the IP camera device, including DHCP, Static IP and PPPoE.

Enable DHCP Service: (Default Setting). The camera is automatically assigned an IP address by the DHCP server when connected to a network.

Use Static IP: Camera may also be manually assigned a static IP address. Subnet mask, Gateway and DNS server(s) will also need to be specified for certain network functionality.

Enable PPPoE Service: This service is usually provided by an ISP (Internet Service Provider). IP Camera can establish a dial-up connection to the ISP and then get connected to Internet.

RTSP Streaming:

The 4 RTSP streaming protocols below are available for different network environments.

UDP: This is unicast method in “RTP over UDP”. UDP is a simple transmission mode and more likely for request of the most up-to-date information. However, video packets may be lost or dropped in the network traffic as UDP does not guarantee the endpoint transmission. This method is usually applied in a smaller scale of LAN or intranet environment where packet lost may not be an issue.

UDP Multicast: This provides RTP over UDP in multicast manner, which is one-to-many communication over an IP infrastructure in a network.

TCP: This is unicast method in “RTP over RTSP (TCP)”. TCP is a reliable for end-to-end data transmission when comparing to UDP mode. Thus, it is applied for quality of the data is concerned. This method is used when data is sent through networks or Internet.

HTTP: It is unicast method in “RTP over RTSP over HTTP”. As firewalls normally allow HTTP protocol, it is not necessary to enable the specific port for RTSP video traffic. That is the IP camera's web page with live video stream can be retrieved through HTTP port.

Network Connectivity:

This page details connectivity configuration, so that IP camera can be accessed without necessarily providing the numerical IP address.

The screenshot shows a web interface with a tabbed menu at the top: "Network Type", "Network Connectivity" (highlighted), "Quality Service", "Access Port", and "Access IP Filter". Below the tabs, the "Network Connectivity" section is expanded, displaying a form with the following fields:

- Enable UPnP Service
- UPnP Name:
- Enable DDNS Service
- Service Provider:
- Hostname:
- Account:
- Password:

An "Apply" button is located at the bottom left of the form area.

Enable UPnP Service: with UPnP enabled, the IP camera device can be easily discovered in Windows Network (My Network Places). See “Discover devices in Windows Network” in previous section.

Enable DDNS Service: By registering this sort of service, the camera can be assigned and accessed over an Internet connection with a hostname instead of IP address. To enable the services, visiting the website of the service provider and registering an account are required.

Quality Service:

Quality Service provides network traffic management to guarantee the quality of services in higher priority, especially when network is insufficient. DSCP (Different Service Code Point) is a 6-bit IP header which defines the service level of the packet. According to the DSCP value, routers with PHB (Per-Hop Behavior) will define a specific class of traffic for the packet, in terms of bandwidth, latency, or loss rate, etc. Enable QoS and set DSCP value for the service to ensure its quality to be maintained.

Quality Service (continued):

The screenshot shows the 'Quality Service' configuration page. At the top, there are tabs for 'Network Type', 'Network Connectivity', 'Quality Service' (which is selected), 'Access Port', and 'Access IP Filter'. Below the tabs, there is a 'Quality Service' section with a dropdown arrow. Inside this section, there is a checkbox for 'Enable QoS / DSCP' which is currently unchecked. Below this, there are three rows, each with a label and a text input field: 'RTSP (0 to 63)' with '0', 'Event (0 to 63)' with '0', and 'HTTP (0 to 63)' with '0'. At the bottom of the section is an 'Apply' button.

Note: To make the QoS function work, all the switches and routers in the network must support QoS.

Access Port:

The Web access port can be changed in this page. Default HTTP and HTTPS port numbers are 80 and 443 respectively. Configuration of these port numbers provides a base level of security.

The screenshot shows the 'Access Port' configuration page. At the top, there are tabs for 'Network Type', 'Network Connectivity', 'Quality Service', 'Access Port' (which is selected), and 'Access IP Filter'. Below the tabs, there is an 'Access Port' section with a dropdown arrow. Inside this section, there are three main settings: 'HTTP Setting' with 'HTTP Port' set to '80'; 'HTTPS Setting' with 'HTTPS Port' set to '443'; and 'Multicast Setting'. The 'Multicast Setting' section contains three sub-sections, each with a checkbox and several input fields: 'Enable Multicast for Streaming 1' (unchecked), 'Multicast Group Address' (238.128.1.99), 'Multicast Video Port' (5560), 'Multicast Audio Port' (5562), and 'Multicast TTL [1-255]' (15); 'Enable Multicast for Streaming 2' (unchecked), 'Multicast Group Address' (238.128.1.100), 'Multicast Video Port' (5564), 'Multicast Audio Port' (5566), and 'Multicast TTL [1-255]' (15); and 'Enable Multicast for Streaming 3' (unchecked), with empty input fields for 'Multicast Group Address', 'Multicast Video Port', 'Multicast Audio Port', and 'Multicast TTL [1-255]'. At the bottom of the section is an 'Apply' button.

Access IP Filter:

This setting also provides a basic security by filtering the accesses from other hosts. Enable this function and choose “Allow / Deny” of the listed IP addresses. Up to 15 IP address can be added in the list.

Network Type Network Connectivity Quality Service Access Port **Access IP Filter**

Access IP Filter

Enable IP Filter

Filter Type Allow Deny

No.	IP Address	Enable
1	<input type="text"/>	<input type="checkbox"/>
2	<input type="text"/>	<input type="checkbox"/>
3	<input type="text"/>	<input type="checkbox"/>
4	<input type="text"/>	<input type="checkbox"/>
5	<input type="text"/>	<input type="checkbox"/>
6	<input type="text"/>	<input type="checkbox"/>
7	<input type="text"/>	<input type="checkbox"/>
8	<input type="text"/>	<input type="checkbox"/>
9	<input type="text"/>	<input type="checkbox"/>
10	<input type="text"/>	<input type="checkbox"/>
11	<input type="text"/>	<input type="checkbox"/>
12	<input type="text"/>	<input type="checkbox"/>
13	<input type="text"/>	<input type="checkbox"/>
14	<input type="text"/>	<input type="checkbox"/>
15	<input type="text"/>	<input type="checkbox"/>

Recording:

This section provides the recording configuration on the camera. Unlike the recording function on the live view page, video is recorded to the storage attached to the camera (that is the SD card) according to a time based schedule.

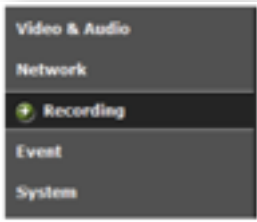

There are four subdirectories within the 'Recording' category:

- Recording Plan
- SD Storage (Only available on certain models. Contact vendor for further details).
- SD File List (Only available on certain models. Contact vendor for further details).
- Samba

Recording Plan:



A screenshot of the 'Recording Plan' configuration interface. At the top, there are tabs for 'Recording Plan', 'SD Storage', 'SD File List', and 'Samba'. The 'Recording Plan' tab is active. Below the tabs, there is a 'Recording Plan List' table with columns for Name, Status, Mon., Tue., Wed., Thu., Fri., Sat., Sun., Src., Dest., and Remove. Below the table, there is an 'Add / Edit Recording Plan' section. It includes a checkbox for 'Enable This Recording Plan', a text input for 'Plan Name', a dropdown for 'Video Source' (set to 'None'), a dropdown for 'Maximum File Size' (set to '200MB'), and a dropdown for 'Destination' (set to 'SD'). Below these fields, there is a date and time stamp '1970/01/02 21:27:13 FH' and radio buttons for 'Select All' (selected) and 'Scheduled Pattern'. Below the radio buttons is a grid for scheduling, with columns for hours 0-23 and rows for days of the week (Mon. to Sun.). The grid is currently empty. At the bottom, there are 'Apply' and 'Remove all schedule' buttons.

Recording Plan List:

The details of a recording plan include:

- Plan Name:** identifier of the recording plan
- Status:** enable or disable the recording plan
- Mon ~ Sun:** displays the hours in days of a week that recording is effective
- Source:** the video source selected to be recorded

Recording Plan List (Continued):

-  **Destination:** the stored path for the recording file
-  **Remove:** click to delete this recording plan.

Recording Plan List											
Plan Name	Status	Mon	Tue	Wed	Thu	Fri	Sat	Sun	Source	Destination	Remove
plan1	Enabled	8-17	8-17	8-17	8-17	8-17	X	X	Stream 1	SD	Remove

Add / Edit Recording Plan:

Maximum File Size: Defines the maximum file size of each video clip.

Select All: 24/7 Continuous recording.

Scheduled Pattern: User-Defined time frame.

All	0	1	2	3	4	5	6	7	8	9	10	11	12	13	14	15	16	17	18	19	20	21	22	23
Mon.																								
Tue.																								
Wed.																								
Thu.																								
Fri.																								
Sat.																								
Sun.																								

SD Storage:

This page shows the SD card information when it is attached to the IP camera. Click on “Refresh” button to update the SD space information. The SD card can be formatted in this page.

Recording Plan	SD Storage	SD File List
SD Card		
SD Card Status	Recording	
Total Size	29.87 GBytes	
Free Size	5.53 GBytes	
Used Size	24.34 GBytes	
Used (%)	81.491%	Refresh
Disk Format	Format	

NOTE

1. It is recommended to insert the SD card before powering up the system. This is to ensure that the attached device is properly detected in the initialization stage.
2. When the SD storage is full, the system will automatically overwrite the earliest recorded files.

SD File List:

This page provides the facility to search recorded files and images. The SD storage may contain both “triggered-by-schedule” recordings and “triggered-by-events” snapshot / video. Search conditions as described here are used to narrow down the search results.

Latest 10 Records:

The most recent 10 records are listed in this table. Each record name is a link to view this video or image. Following the “Record Name”, each record is listed with its “Trigger Type” and “Record Size” details.

▶ Latest 10 Records		
Record Name	Trigger Type	Record Size
20101210111505125_E.jpg	Motion Detection	94 KB
20101210111503949_E.jpg	Motion Detection	95 KB
20101210111502777_E.jpg	Motion Detection	94 KB
20101210111454709_E.avi	Motion Detection	1 MB
20101210111452393_E.jpg	Motion Detection	94 KB
20101210111451260_E.jpg	Motion Detection	96 KB
20101210111439639_E.avi	Motion Detection	1 MB
20101210111335085_E.jpg	Motion Detection	94 KB
20101210111335055_E.avi	Motion Detection	1 MB
20101210111333918_E.jpg	Motion Detection	95 KB

▶ Searching the Records	
Search Criteria	
Trigger Type	
<input type="checkbox"/> Motion Detection	<input type="checkbox"/> Schedule Recording
<input type="checkbox"/> Manual Recording	<input type="checkbox"/> Network Fail
<input type="checkbox"/> Digital Input	
Trigger Time	
From Date <input type="text"/>	Time <input type="text"/>
To Date <input type="text"/>	Time <input type="text"/>
(yyyy-mm-dd)	(hh:mm:ss)
File Type	
<input type="checkbox"/> AVI	<input type="checkbox"/> JPEG
<input type="button" value="Search"/>	

Search Records:

After the Recording Plan and/or Event Handling (see Event Management) is launched for a certain time, the records held in the SD Storage medium could become considerable in size. Therefore this facility provides various criteria to simplify specific searches. There are 3 categories of search criteria:

1. **Trigger Type:** It includes [Motion Detection], [Digital Input], [Manual Trigger] and [Network Fail] as the type of “triggered-by-events” and [Schedule Recording] as the type of “triggered-by-schedule”.
2. **Trigger Time:** Input Date / Time range that recording was created.
3. **File Size:** Select the file type that is either video clips (.avi) or pictures (.jpeg) or both.

Searching the Records

Search Criteria

Trigger Type

Motion Detection Schedule Recording

Manual Recording Network Fail

Digital Input

Trigger Time

From Date Time

To Date Time

(yyyy-mm-dd) (hh-mm-ss)

File Type

AVI JPEG

Search Result

Record Name	Trigger Type	Record Size
<input type="checkbox"/> 20101207090452709_E.jpg	Network Fail	85 KB
<input type="checkbox"/> 20101207090451617_E.jpg	Network Fail	85 KB
<input type="checkbox"/> 20101207090441823_E.avi	Network Fail	1 MB
<input type="checkbox"/> 20101207090025323_E.jpg	Network Fail	90 KB
<input type="checkbox"/> 20101207090024207_E.jpg	Network Fail	85 KB

Page: 1 / 1

NOTE

Searches can include multiple criteria. For instance, the search result can be the combination of Network Fail and Digital Input.

Event Management:

Event management describes the handling of events with the corresponding actions. A common case can be exemplified is storing a captured image to a local storage (Actions), when there is a Motion Event (Trigger Condition). This chapter gives the configurations of Triggers (what to detect?) and Actions (“what to send” and “where to send”). A time based schedule can also be applied.

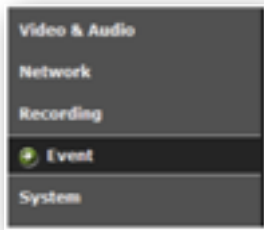

Event Management Configuration:

There are 4 subdirectories in the “Event” category. The 4 configuration groups are correlated. A completed event setting may need to configure each part in sequence.

- 🔑 **Event Server & Media**
- 🔑 **Motion Configuration**
- 🔑 **DI / DO Settings**
- 🔑 **Event List**

Event Server & Media:

The “Event Server” is the configuration of “where to send”, e.g. FTP server, while Media is the sending file type. The combination of file type and the remote servers will then be applied as an event action.

Event Server List:

Click on “Add New” button to add the remote servers. These are email recipients and FTP server.

Email: Send the media file via email when an event is triggered.

Mail Server Address: Enter a host name or IP address of the email server.

User Name: Enter the user name of the email account.

Password: Enter the password of the email account.

Server Port Number: Enter the server port of the mail server. The default is 25.

Sender’s E-mail Address: Enter the email address of the sender

Mail Subject Prefix: Enter the subject description for the mail.

Receiver Table: Enter the recipients’ email address. The mail can be sent to up to 5 recipients.

FTP: Send the media file to a FTP server when an event is triggered.

FTP Server address: Enter the FTP server’s address.

User Name: Enter the user name of the FTP login account.

Password: Enter the user name of the FTP login password.

Server Port Number: Enter the server port of the FTP server. The default is 21.

Event Server List (Continued):

Upload Path: Enter the file path that files will be sent to.

Index	Email Address	Description
1		
2		
3		
4		
5		

Media Type:

There are 2 types of media (file) available, snapshot (.jpg image) and video clip (.avi).

Video Source: Select the video source to be captured

Pre-alarm / Post-alarm image(s): Enter the numbers of images that will be captured before and after trigger is activated.

Pre-alarm / Post-alarm video: Enter the numbers of seconds that video will be recorded before and after trigger is activated.

Maximum file size: Define the maximum file size that a video clip is generated.

Media Type (Continued):

Event Server & Media Motion Configuration DI/DO Setting Event List

Event Server List

Server Name	Server Type	Address	Remove
<input type="button" value="Add New"/> Note: Maximum number of event server list is 2.			

Media Type

Snapshot

Video Source Stream 1

Send 1 pre-alarm image(s) [0-7]

Send 2 post-alarm image(s) [1-7]

Video Clip

Video Source Stream 1

Pre-alarm record 10 seconds [0-10]

Post-alarm record 10 seconds [1-10]

Maximum file size 5000 Kbytes [500-5000]

Motion Configuration:

Up to 3 MD (Motion Detection) areas can be enabled. Each MD can be individually enabled/disabled, covering range defined and trigger sensitivity set.

To enable and verify MD areas, follow the steps provided below:

1. Check the box to enable the motion area
2. Drag and drop to position the motion window
3. Hold and drag any corner of the rectangle to resize the window.
4. Adjust the detection "Sensitivity" and "Object Size" of the MD area by dragging the pin of the slider bars.

NOTE:

The "**Sensitivity**" setting applies to the sensitivity level of the motion detection feature; the higher the value, the more sensitive the activation trigger. "Object Size" indicates the trigger threshold. A lower "Object Size" value means it is easier to exceed the value, and thus trigger the motion event.

5. The status chart shows motion activities. When the motion vector exceeds a threshold (the Object Size), the motion trigger is activated.
6. To enable other motion areas, repeat the steps above.
7. Click on the "Apply" button to save the settings.

Motion Configuration (Continued):

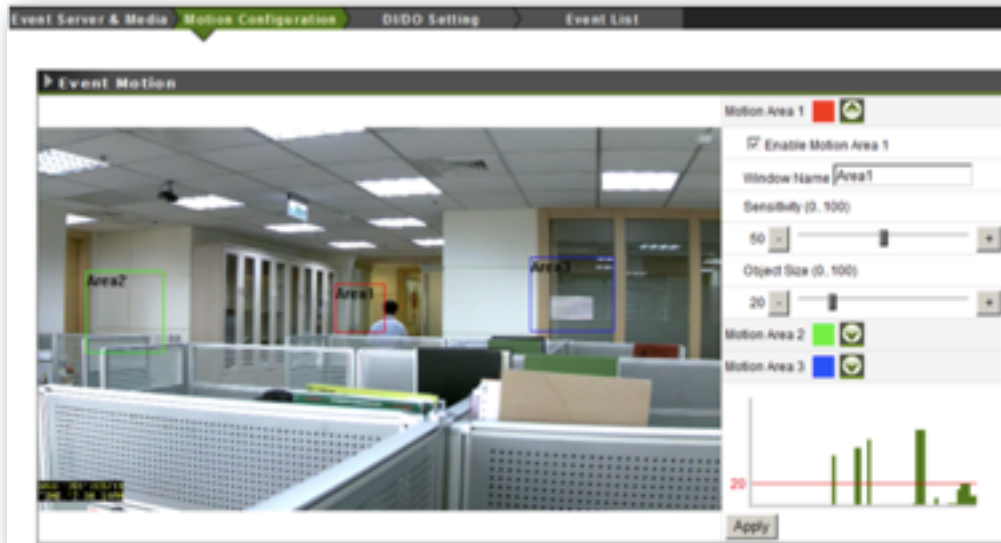

DI / DO Setting: (Not available on all models. Contact Vendor for details)

The DI/DO setting provides the information of Digital I/O's initial and current status. The initial status can be configured while current status is detected by the IP camera system.

Digital input (DI) can be configured as one of the trigger conditions. When its current status is different from the initial status, the trigger is activated.

Digital output (DO), on the other hand, can be one of the responding actions. When its current status is different from the initial status, the output is triggered.

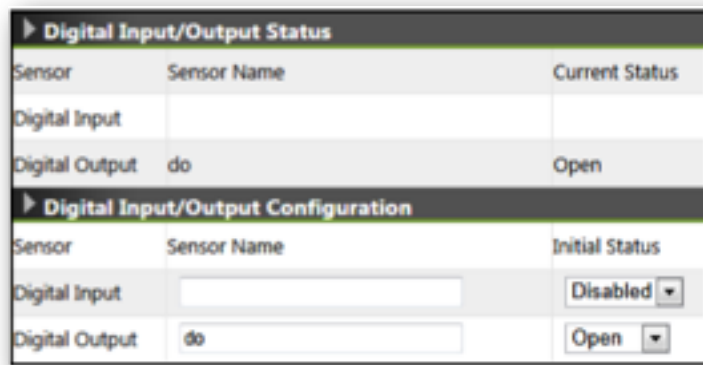

Event List:

Lists a summary of configured events. That is the configuration of trigger condition(s) and the corresponding actions, as well as the scheduling. Up to 10 event objects can be configured.

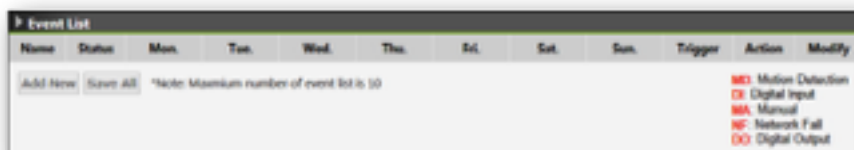

Event List (continued):

Click on “Add New” button to reveal the detailed configuration panel.

Event List

Name	Status	Mon.	Tue.	Wed.	Thu.	Fri.	Sat.	Sun.	Trigger	Action	Modify
------	--------	------	------	------	------	------	------	------	---------	--------	--------

*Note: Maximum number of event list is 10

MD: Motion Detection
DI: Digital Input
MA: Manual
NF: Network Fail
DO: Digital Output

Add / Edit Event List

Enable This Event

Event Name:

1970/01/02 22:57:56 Fri
 Select All
 Scheduled Pattern

All 0 1 2 3 4 5 6 7 8 9 10 11 12 13 14 15 16 17 18 19 20 21 22 23

Mon.
Tue.
Wed.
Thu.
Fri.
Sat.
Sun.

Triggered by

Motion Detection
 Motion Area 1 Motion Area 2 Motion Area 3
 Digital Input
 Manual Trigger
 Network Fail

Action

Trigger digital output for seconds

Upload files to a server

Event Server Media Type

-Select Event Server- -Select Media Type-
 -Select Event Server- -Select Media Type-
 -Select Event Server- -Select Media Type-
 -Select Event Server- -Select Media Type-

Event Name: Enter an event name, e.g. Motion Detection, to identify this configured event.



Select All: 24/7 continuous recording Scheduled Pattern: User-defined time frame

Triggered by: Select trigger conditions (as listed below):

- Motion Detection:** Select the motion detection area(s) used for trigger condition. To enable and configure the motion detection areas, go to *Motion Configuration*.
- Digital Input:** Enable system to detect the DI (Digital Input) status as a trigger condition. For more details about the DI setting, go to *DI/DO Setting*.
- Digital Input:** Enable system to detect the DI (Digital Input) status as a trigger condition. For more details about the DI setting, go to *DI/DO Setting*.
- Manual Trigger:** Enable system to detect the user input action (press the alarm button, on the live view page).
- Network Fail:** Enable system to detect the network connection status.

Event List (continued):

Action: Two actions are available upon activation of trigger:

-  **Digital output:** Check the box to enable the digital output as a responding action. For detailed configurations, go to *DI/DO Setting*.
-  **Upload files to a server:** This sort of action contains 2 variables; selection of the destination and selection of file type. The destination includes the local SD storage, an FTP server or email recipients. The file type includes snapshot image and video clip. For detailed configurations, go to *Event Server & Media*.

System Options:

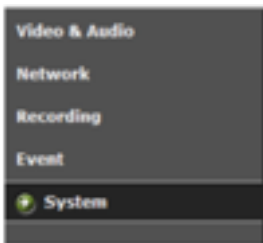

System Information:

This page allows details of the IP camera system to be defined.

In **System Status**, the Model ID, Firmware Version and MAC Address are listed. The Camera Name and Location fields are revisable to identify a unit among multiple cameras installed.

The IP address info of this IP camera is listed in **Network Status**. The RTSP Status field shows the video stream(s) being requested by the listed client(s).

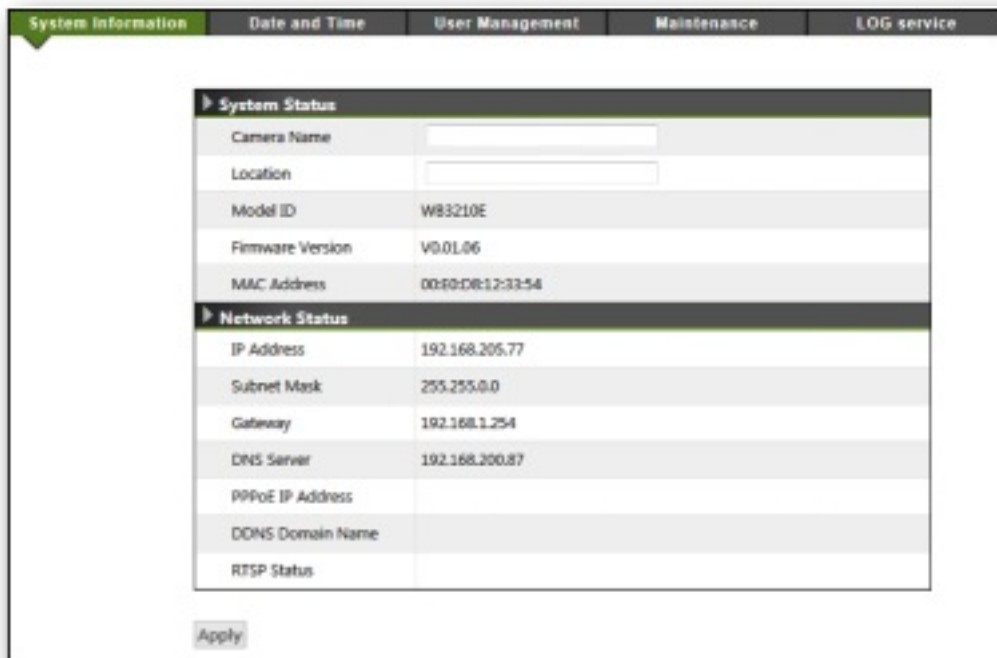

The screenshot shows a web interface with a navigation bar at the top containing: System Information (active), Date and Time, User Management, Maintenance, and LOG service. Below the navigation bar is a table with two sections: System Status and Network Status.

System Status	
Camera Name	<input type="text"/>
Location	<input type="text"/>
Model ID	W83210E
Firmware Version	V0.01.06
MAC Address	00:10:00:12:33:54

Network Status	
IP Address	192.168.205.77
Subnet Mask	255.255.0.0
Gateway	192.168.1.254
DNS Server	192.168.200.87
PPPoE IP Address	
DDNS Domain Name	
RTSP Status	

Apply

Date and Time:

Date and time adjustments for the IP2 camera are defined within this section. Settings can be set to automatic (Synchronise with NTP Server / PC) or manual.

Current Date & Time	
Date (yyyy/mm/dd)	2010/11/12
Time (hh:mm:ss)	14:34:24

Configure Date & Time	
<input type="radio"/> Keep Current Date & Time	
<input type="radio"/> Synchronize with NTP Server	
NTP Server Address	time.windows.com
Update Interval	Daily
<input checked="" type="radio"/> Synchronize with PC	
Computer Date	2010/11/12
Computer Time	14:33:49
<input type="radio"/> Set Manually	
Date	2010/11/12
Time	14:34:15
Date Display Format	YYYY/MM/DD
Time Zone	GMT
<input type="checkbox"/> Daylight Saving Time Enable Automatically	

Apply

Current Date & Time:

Display current system date/time settings. The date format can be changed from the drop-down list in **Configure Date & Time**.

Configure Date & Time:

Keep Current Date & Time: The option of keeping current date and time, not to be adjusted.

Synchronise with NTP Server: automatic method for date/time adjustment. The IP Camera must be able to gain access to the given NTP server (e.g. time.windows.com), which is usually via an Internet connection. The IP camera system can therefore synchronize with the time server.

NOTE: To apply “synchronise with NTP Server”, a **Time Zone** must be selected for referencing to the local time.

Synchronise with PC: The PC connected to the IP camera can also provide date/time information. However, if the PC is connecting from a **time zone** different from where camera is installed, the system will display a warning message for time zone differential.

Set manually: Manually adjust the date / time for the system

Date Display Format: The system date can be displayed in the format of DD/MM/YYYY, MM/DD/YYYY or YYYY/MM/DD.

Time Zone: Select an appropriate time zone for local where IP camera is installed. The automatic adjustments will be applied based on the selected time zone. Check the “Daylight Saving Time” checkbox for areas that are observing DST.

User Management:

By default, access to the camera is not user authenticated. For security, the IP camera should be restricted to account only access. It is able to enable user accounts, as well as to manage the added users from this page.

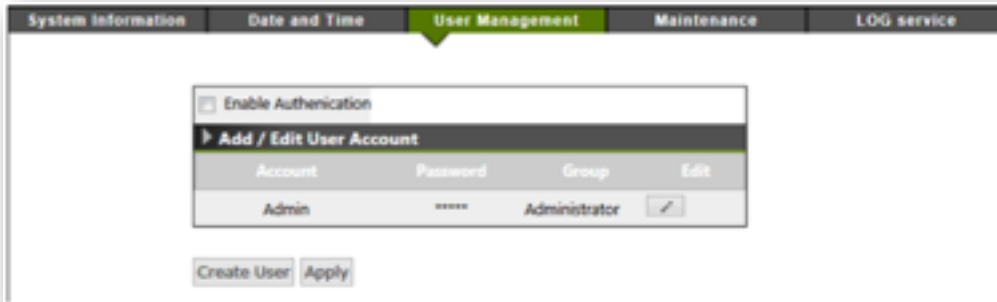

Initially, there is a default account, **Admin** in the “User List”. To enable this account, click on “Enable Authentication” and then apply. To edit password for the default account, click “Edit” to enter the configuration window.

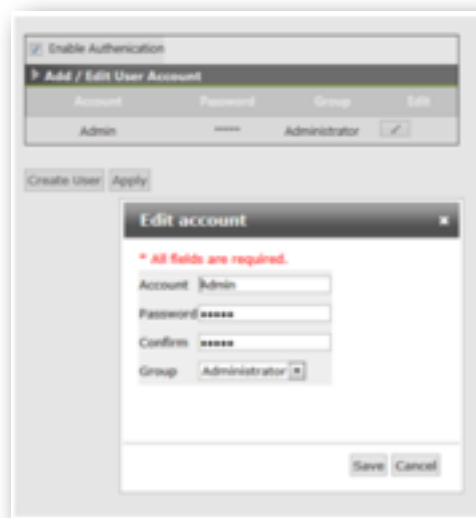

To create a new account, click “Create User” button. Enter Account / Password for this account with the group type on the “Create account” window.

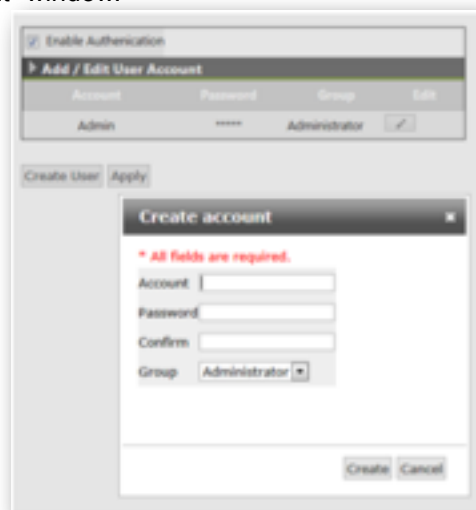

Users with “**Administrator**” account authentication have full administrative access. “**Operator**” has the same rights as Administrator, except for **User Management** configuration. “**Viewer**” is allowed only the access to live view page. Up to 8 user accounts can be added in the User List.

Maintenance:

This page provides tools for camera system maintenances.

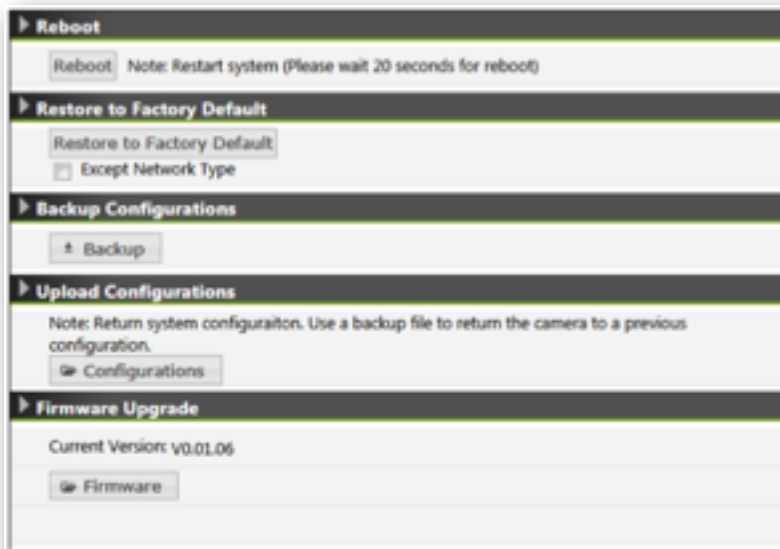

Reboot: Restarts the camera system

Restore to Factory Default: Restore camera factory default settings. Network setting can be kept by checking the “**Except Network Type**” checkbox.

Backup Configurations: System settings can be backed up and exported to a file. The file can be applied to upload the previous user settings to the camera, or other cameras.

NOTE

The backup file can be applied to other IRIS IP2 cameras, so users won't need to configure each device. It is recommended to switch the IP setting to DHCP mode before exporting the backup file, Otherwise, all IP cameras will have the same IP address.

Firmware Upgrade: Upgrades firmware for the camera. Retrieve the firmware image file, import to the camera and then instigate the upgrade process.

LOG Service:

System operations and / or process are recorded in the log system. These links allow the various log records to be reviewed.



System Log: Contains records of system changes such as login failed or link on/off.

Event Log: Records the log message of triggered event, for instance, motion detection activation.

Parameter List: Lists system parameters with current values.

Install Micro-SD Card (not supported on all models - please check with your vendor for details):

The IP2 camera supports on-board Micro-SD storage. Due to the water-resistance design, it is necessary to follow the SOP provided below to complete the installation properly. Please note, this feature is not available on certain models. Please consult your supplier for further details.

PLEASE NOTE:

IRIS PREFIT ALL CAMERAS WITH SD CARDS. THEREFORE WE STRONGLY RECOMMEND THE UNIT IS NOT DISMANTLED. IN THE EVENT OF A FAULT, PLEASE CONTACT YOUR IRIS DEALER!

Step 1: Unscrew the rear cover of the camera:

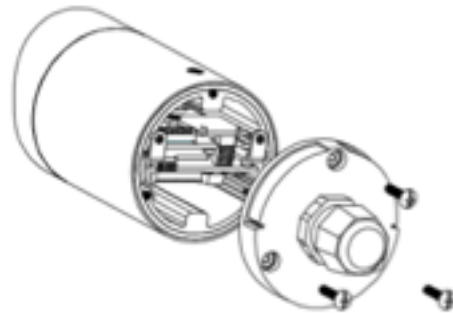

Step 2: Carefully open the rear cover and find the card slot for installation:

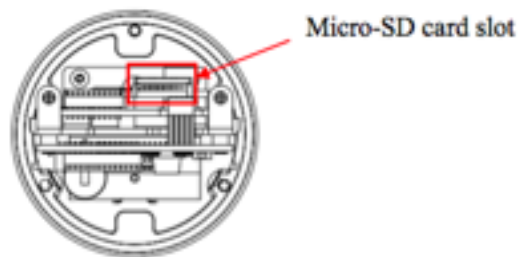

Step 2: Carefully open the rear cover and find the card slot for installation:

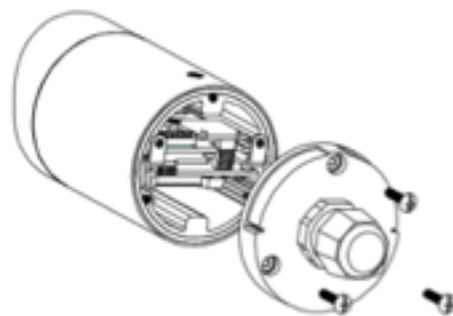

Troubleshooting:

Check Firmware Version:

In the event of a problem occurring with the functionality of the camera, it's always best to ensure the latest version of firmware is installed as the issue may have already been addressed by a new firmware release. Therefore the first step of troubleshooting functionality issues is always to check the firmware version number and establish whether a subsequent release is available.

The firmware version number can be found in **Setup -> System -> System Information**. See screen-grab below:



System Status	
Camera Name	<input type="text"/>
Location	<input type="text"/>
Model ID	IRIS402
Firmware Version	V0.01.06
MAC Address	00:E0:D8:12:33:54

Upgrade Device Firmware:

Firmware upgrade process should be done via the cameras web connection (as opposed to the SD card for example): **Setup -> System -> Maintenance -> Firmware Upgrade**. Before the process, read the instructions and release notes coming with each new released version.

Read Prior to Upgrading:

1. The latest firmware image is available on Iris' official website:

<http://www.boat-cameras.com/product.php?ProdID=48&CatID=12>

2. Make sure all other client connections are disconnected and current jobs such as recording are finished.
3. During the upgrading period, **DO NOT** disconnect the power to the camera, otherwise the cameras memory might become damaged necessitating 'outside warranty' repair.
4. The front LED indicator will flash red slowly during the upgrading procedure. When the LED changes to steady green, the upgrading process is completed.

Firmware Upgrading Procedure:

1. Go to firmware upgrade page on the cameras web interface. **Figure 1**
2. Click "Firmware" button to open browser pane to navigate to and select the firmware image. **Figure 1**
3. Click "Upgrade" to begin (the upgrade progress bar will pop up). **Figure 2**
4. Once the upload is complete, the system will reboot automatically. The new firmware will load in at this point.
5. Go back to firmware upgrade page and confirm if the "current version" is up-to-date. **Figure 3**

Upgrade Device Firmware (continued):

Figure 1.

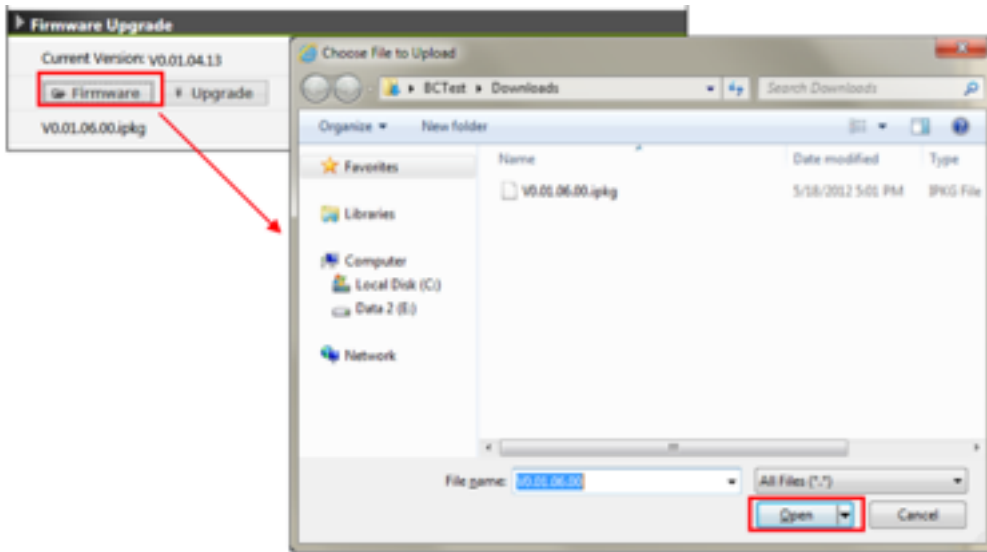

Figure 2.

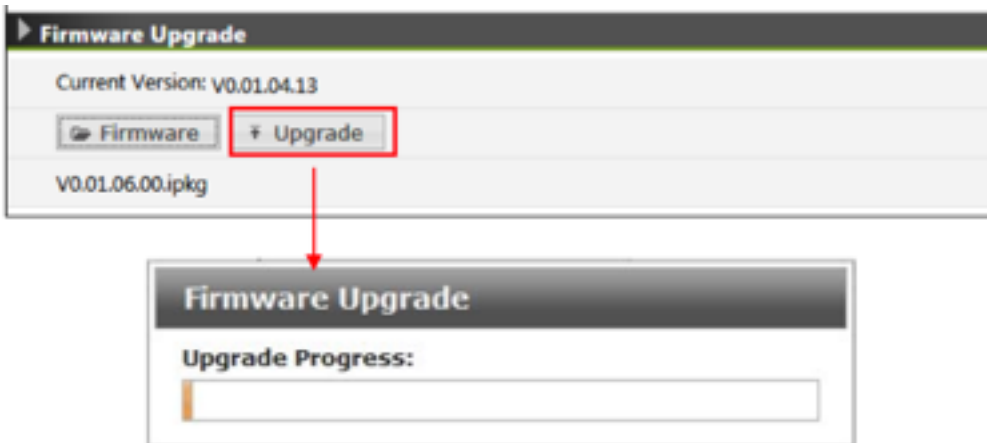
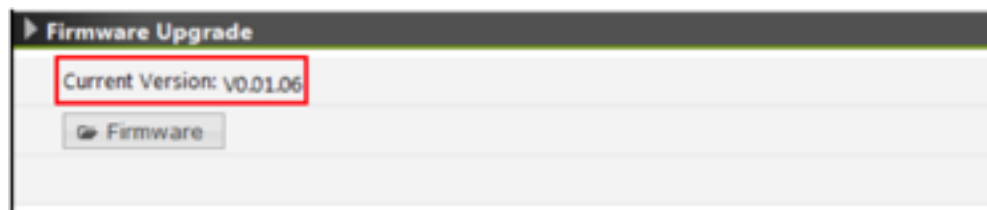

Figure 3.



Restore to Default Settings :

In certain situations whereby the camera 'locks up' or fails to respond to communications / commands etc it may be necessary to carry out a system reset, restoring the cameras configuration to it's factory settings. This is achieved by using the Reset button.

Due to the water-resistance design, the Reset button is located inside the housing. To press the Reset button, it is necessary to open the rear cover. To learn the procedures, please refer to the previous "Install a Micro- SD card" section.

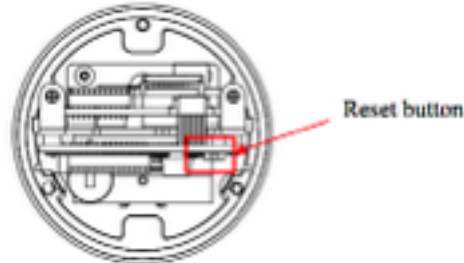

1. Restart / Reboot the device

Press and release the **Reset Button**. Within 1 second, the system will be restarted (the **LED Indicator** will be **steady amber**). Upon successful reboot, the LED will be **steady green** during normal operation.

2. Reset User Management

Press and hold the **Reset Button** until (around 5 seconds) the **LED Indicator flashes green**. User management settings will be reset to default (the LED keeps **amber** during the process). Upon successful restore, the LED will be **steady green** during normal operation.

3. Reset to factory default settings

Press and hold the **Reset Button** until (over 10 seconds) the **LED Indicator** becomes **red**. The system will start to process restoring settings (the LED keeps **amber** during the process). Upon successful restore, the LED will be **steady green** during normal operation.

LED Indicators :

RJ45 LED's (Standard 'Non Waterproof' Models Only:

	LED1 (Green)	LED2 (Amber)
10 Link / Traffic	Steady ON / Flashing	OFF / OFF
100 Link / Traffic	Steady ON / Flashing	Steady ON / Steady ON

Power & System Status LED's:

	Green	Red
Power On / System Reboot	Steady ON	Steady ON
Initial Process Ready	3 Flashing then ON	OFF
Normal Operation	Steady ON	OFF
Firmware Upgrade	OFF	Flashing (per second)
Internal (Hardware) Failure	OFF	Steady ON

Technical Specifications : IRIS402

	Iris IP2
System	Embedded Linux, ARM based 32-Bit RISC Processor, 16MB Flash ROM
Video Compression	H.264, MPEG4, MJPEG
Resolution	Up to HD1080 (1920x1080)
Frame Rate	30fps
Image Sensor	1/2.7" Progressive Scan CMOS sensor
Lens	Board type, 4.0mm, F1.5, Fixed Iris as standard. Others by request
Minimum Illumination	0 Lux with IR ON
Image Settings	ICR (Removable IR-cut filter) for Day & Night Vision
	WDR / AEC / AWB / Brightness, Contrast, Saturation, Sharpness
	Image Flip & Mirror
	OSD Timestamp and text caption overlay
Event Triggers	Motion Detection, Digital Input, Manual Trigger
Event Actions	Digital Output
	Email Notification, FTP, SD with attached video clip or snapshot
On-board Storage	Micro SD card slot (4MB Max)
Network Interface	10/100 Base-T ethernet
Network Protocols	IPv4, HTTP, HTTPS, SMTP, FTP, DHCP, NTP, TCP/IP, UpnP, RTSP/RTP/RTCP, DNS, DDNS, PPPoE, IGMP, QoS, Bonjour, Samba, Multicast
Power Supply	DC 12V / 2A Maximum. Built in PoE IEEE 802.3af compliant
Operating Temperature	-10°C ~ 50°C (14°F ~ 122°F)
Operating Humidity	20% - 90% RH
Dimensions (L x W x H)	114mm x 60mm x 60mm
Net Weight	548 grammes
Approvals	CE, FCC, ONVIF Compliant
Connections	1 x RJ45 ethernet LAN connector
	2 x Phono Jacks (external MIC In and Audio out)
	1 x DC 12V Jack connector 2.1mm Barrel type.
	1 x BNC Connector
	Micro SD Card Slot

For specific mounting options contact Iris Innovatiions. Camera body features 2 x standard 1/4" Whitworth camera mounting threads.

Iris Innovations Limited UK

Units 8 & 9 Swanwick Business Centre
Bridge Road, Swanwick. Hampshire SO31 7GB
United Kingdom.

Tel: +44(0)1489 570797

email: info@boat-cameras.com

www.boat-cameras.com

Iris Innovations Limited USA

1515 SE17th Street, Suite A133
Fort Lauderdale 33316
Florida
United States of America

Tel: +1(954) 533 9381

email: info@boat-cameras.com

www.iris-innovations.com