

SITEX®

MARINE ELECTRONICS







SVS-460 & SVS-560

OPERATION MANUAL

Pictorials





This manual uses the following symbols for easy understanding safety instructions. Always follow these instructions carefully.

 WARNING	Always follow this safety instruction to prevent death or injury.
 CAUTION	Follow this safety instruction to avoid possible injury or damage to your property. Symbol “△” is a CAUTION or WARNING label indicating the safety instruction.
 WARNING	This symbol is an Electrical Shock WARNING label.
	Symbol is an instruction that you must not violate. (This symbol instructs NOT to disassemble the system components)
	Symbol is an operation instruction that you must follow. (This symbol shows the main power OFF instruction.)



WARNING <For System Operators>

Always follow this instruction to prevent death or personal injury.

	Turn power off During abnormality.	If smoke or a small of burning occurs, a fire or an electrical short circuit may result. Turn the power switch OFF and shut down the power supply immediately. Never try to repair the system yourself. Call for service.
	Do not open Cabinet.	High voltage exists in the instrument. Contact with voltage may cause possible injury or death.
	Do not touch back side of the equipment.	Harmful line voltage is present on back side of the equipment. Never try to touch back side while power is turned on.
	Avoid excessive shock to display unit.	The LCD display module contains a liquid. Do not apply any mechanical shock to the display. If the display broken, liquid may leak and injure your skin and eyes.
	Do not use with poor ventilation.	If you cover this unit or use in an enclosed place, it may malfunction or become damaged as a result of overheating. Use only where there is sufficient ventilation.



Installation Cautions <For service Personnel>

Follow installation instructions to avoid personal injury and system malfunction.

Installation in rigid location.	Mount your SVS-560/460 on a rigid frame or base to prevent your unit from working loose.
Use correct Installation materials.	Use the installation materials provided in the standard accessory pack only. If you use hardware of insufficient strength, your system may loosen causing damaged.
Keep away from direct sunlight.	Keep your system out of direct sunlight as it may become damaged by overheating.
Keep away from water.	Take care not to get water on or in your unit as it may be damaged and/or cause an electrical shock.
Keep away from heat source.	Keep your system away from other heat source as it may malfunction, be damaged, or burn.
Use correct power source.	Operate your system within the specified power voltage. An incorrect power supply may cause



Maintenance Cautions<For Maintenance Personnel>

Use the following safety precaution internal inspection.

Discharge capacitors.	High voltage may be retained in the capacitors if the high-tension circuit several minutes after you have turned the power switch off.
Check that power is OFF	To prevent an electrical injury due to erroneous power switching, make sure that the main power supply and the system power switch are both in the off position. Additionally, attach a safety label showing that service is in progress.
Avoid EMI.	Take care not to damage the ESDs (Electrostatic Sensitive Devices) by static electricity from carpet and cloths.
Avoid dust.	Wear a safety mask so as not to breath in dust during inspection or cleaning inside your system instruments.

Operation Notes <For operators>

Observe the following operation notes, otherwise the system failure or deterioration can result. And periodical inspection and maintenance are required for keeping the system in an optimum condition.

Backup important data.	The waypoint and other registered data may become unreadable by unexpected failure. We recommend recording this data separately.
Use correct transducer only.	If you use incorrect transducer, the transmitter circuit may be damaged due to a matching error. Consult us for system information.
Check transducer Connection before power on	Do not turn the power switch ON if the transducer is disconnected or if it is not inserted into the water. If done, the transducer or transmitter circuit may be damaged.
Always clean the transducer	Since transducer performance can drop due to accumulated bottom growth, keep the transducer clean. Never paint transducer surface.
Transducer must be installed by authorized personnel.	Consult us for transducer installation by authorized personnel.

 WARNING	This product is designed to assist a navigation. When you are sailing, use the certified chart from the Government or IMO.
----------------------------------------------------------------------------------------------------	-------------------------------------------------------------------------------------------------------------------------------

SVS-560/460 Series

CAUTION

The **SVS-560/460 Series** Color LCD Chartplotter & Fishfinder Systems employs the latest in proven technology to provide accurate fish & bottom information. The Plotter functions of SVS-560/460 series are totally dependent upon the capability of the navigation source to provide accurate position information. This device is only an aid to navigation. It should be used in conjunction with all other navigation accuracy. For safety, always resolve any uncertainty before continuing navigation. There is no direct relationship between the color of water areas and their depth. The navigator shall always query the area for depth information and use the official paper chart.

CAUTION

The performance of LCD displays are degraded by continuous direct exposure to ultraviolet rays. Locate your SVS-560/460 series Display away from direct sunlight. When not in use. Keep the display covered.

DISPLAY BREAKAGE WARNING

The LCD display module contains a liquid. If the display is broken and the liquid contacts your skin, wash it off immediately in running water for 15 minutes. If the liquid contacts your eyes, immediately flush your eyes with running water for 15 minutes. Contact a physician if any abnormal symptom is experienced.

INDICATION NOTICE

*: It is important or warning notice on front of article

#: It is only functions for the SVS-560CF/SVS-460CF on front of article.

[]: Keyboard.

SVS-560/460 series Introduction

Fix Text Below, so that Words Do Not Separated Strangely at End of each Line.

For centuries, sailors have been searching for a reliable and precise method of travelling the world's waterways. From celestial navigating to the modern navigation techniques as Loran, Decca navigator, Omega or Transit Satnav, each system has had its problems with weather, range and reliability. Without doubt, the "Global Positioning System", or GPS for short, is the most significant advance in navigation: it provides the navigator a position 24 hours a day, 365 days a year in any weather condition. GPS is a satellite based navigation system which provides suitably equipped users with accurate position, velocity and time data. Originally the GPS, developed by the U.S. Department of Defense, was conceived for military purposes, but now it is used in a host of civilian applications. GPS navigation uses satellite signals to determine your position in relation to a set of satellites orbiting the earth. The GPS constellation of satellites continuously sends radio signals, containing the precise position for each satellite back to earth. By knowing the position of 3 or 4 satellites and calculating various time differences between transmitted signals, the GPS receiver can determine its present position anywhere on earth, and thanks to continuous updates, calculate speed and course information.

Display Unit Installation

Temporarily install the mounting bracket on the Genesis display unit and place the unit at the selected location.

CAUTION

The Smart4/5 series display unit is unstable when the mounting bracket is not secured. Hold the unit in place at all times.

Check the suitability of the location and make any adjustments. When all is satisfactory, use the holes in the mounting bracket as a guide and mark the holes locations on the mounting surface.

Drill a 1/4 in. diameter hole at each marked location. Mount the Smart4/5 series display bracket using

bolts through the mounting surface. Place large flat washers on the opposite side of the mounting surface from the bracket and then install lock washers and nuts. Tighten securely.

Install the display unit into the mounting bracket. Check alignment and operation of the pivots and security of the mounting. Make any adjustments necessary to prevent binding and assure even meshing of the pivot locking washers. It is advised to remove the display unit and store it in a safe place to prevent damage during the rest of the installation process.

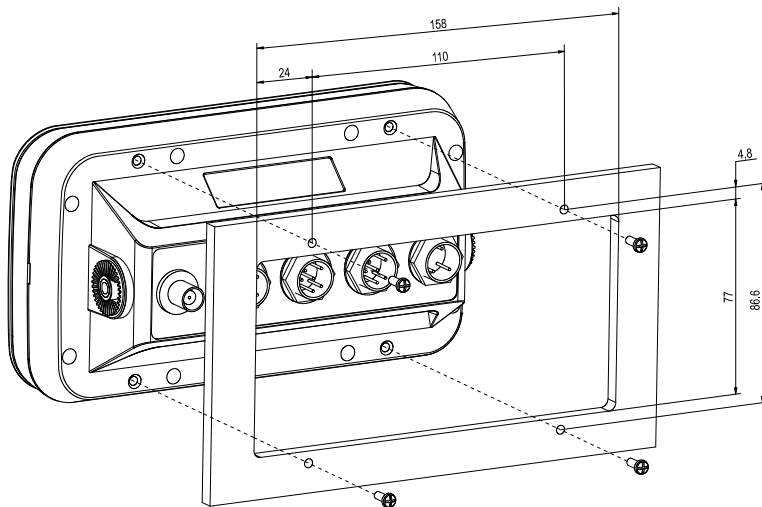
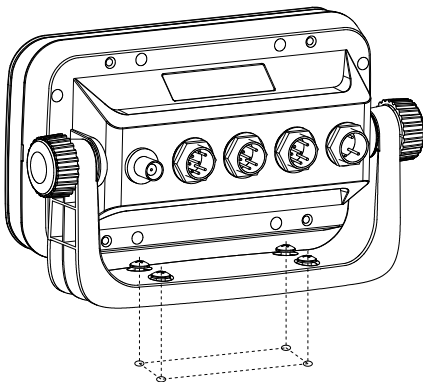

SVS-560/460 series Introduction

HOW GPS WORKS

Currently, the GPS constellation consists of 26 orbiting satellites (including 3 spares), but this number will increase in the future.

The GPS receiver computes an accurate position by calculating the distance to the GPS satellites that orbit the earth. Signals are required from 3 satellites for two dimensional (2D) position calculation whilst 4 satellites are required for three dimensional (3D) position calculation.

As mentioned earlier, GPS satellites are not geostationary, but they are orbiting the earth as illustrated on the following figure:

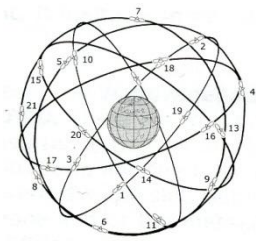

[The GPS constellation]

Note that position is repeatedly fixed through the following three steps while any 3 satellites are in line of sight.

The position calculation procedure is indicated in the following three steps:

1. GPS satellites continuously transmit their own precise orbital data and the GPS receiver computes their locations by receiving this data.
2. In this receiving process, the GPS receiver measures very accurate distances to the satellites, using the "Spread Spectrum Modulation" method. Excellence in GPS's position-fixing accuracy is mainly due to this technology.
3. When the satellite locations and their distances are known, the GPS receiver fixes its own position by triangulation:

SVS-560/460 series Introduction

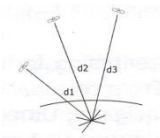

[The GPS position calculation]

As illustrated in the previous figure, the position is calculated as the meeting point of three spheres, which are drawn around the three satellites with diameters d_1 , d_2 and d_3 .

Position Fixing Accuracy: HDOP

The GPS fix accuracy is due to the locations of 3 satellites in the sky. High accuracy is obtainable when the satellites are widely scattered in the sky; on the contrary, accuracy is reduced when the satellites have gathered in a narrow space. In the following figure, in both cases it is possible to obtain the GPS fix, but in the left case the accuracy will be higher than the right:

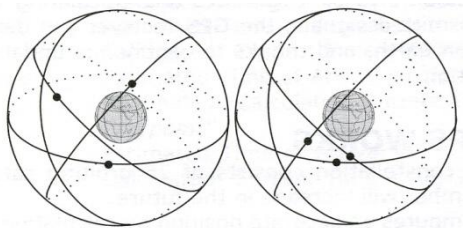

[HDOP]

The index for position-fixing accuracy is called HDOP ("Horizontal Dilution Of Precision"). The smaller the HDOP value, the more accurately the position can be fixed.

SVS-560/460 series Introduction

#Fishfinder - How it works-

The **SVS-560/460CF** echo sounder consists of a **transceiver** display unit and a dual frequency transducer. An electronic signal pulse is generated in the transmitter section of the display unit. When coupled to the transducer, this signal is converted into an ultrasonic signal and is transmitted toward the bottom. The signal travels through the water until it strikes an object or the bottom. It is reflected back, hits the transducer surface, and is reconverted into an electronic signal by the transducer. Then it is amplified in the receiver section, processed in the main logic section, and displayed, as an image on a LCD screen. (Picture 3)

When your boat travels from point A to point B as shown in Picture 1, the beam of the transducer installed on your boat shown a cross-sectional view in the water.

Picture 2 indicates a cutaway view under the water when your boat moves from A to point B.

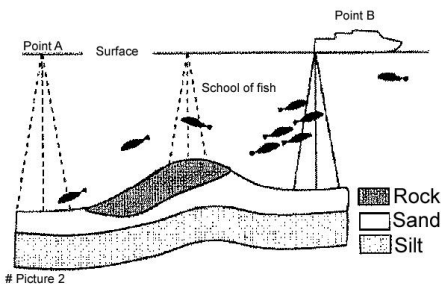
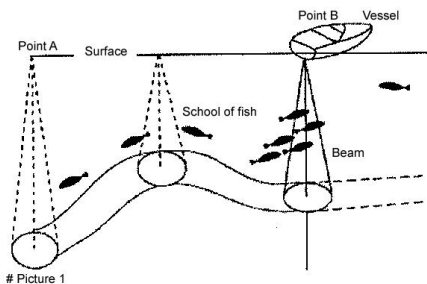

The screen shows the latest scan data at its right position. After the next scan, the previous data is moved to the left and the latest scan data is shown at the right position. When your boat moves from point A to point B, the screen shows the scan data as shown in Picture 3.

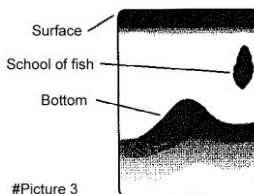

Installation of GPS ANTENNA

The installation of the GPS ANTENNA.

The GPS ANT must be installed at the highest area of the boat and the easiest place to receive the signal from the satellites. If there are obstacles around the GPS ANT, it isn't able to receive all signals. The receiving time could be longer or the receiving power would be weaker. Please, follow the instruction for your installation.

1. Keep from a metal.
2. Over 4m away from a MF/HF ANT, VHF or HF whip ANT.
3. Over 1.5m higher than MF/HF ANT.
4. Over 1m away from a receiving ANT.
5. Don't put the GPS ANT into the range of radar's beam. (Range: 30° ~ 40°)
6. Over 1m away from the scanner of the radar.
7. Over 5m away from the ANT of the Inmarsat.
8. Over 3m away from the ANT of the roof.
9. Over 2m away from the engine.
10. Over 0.5m away from the metal surface.

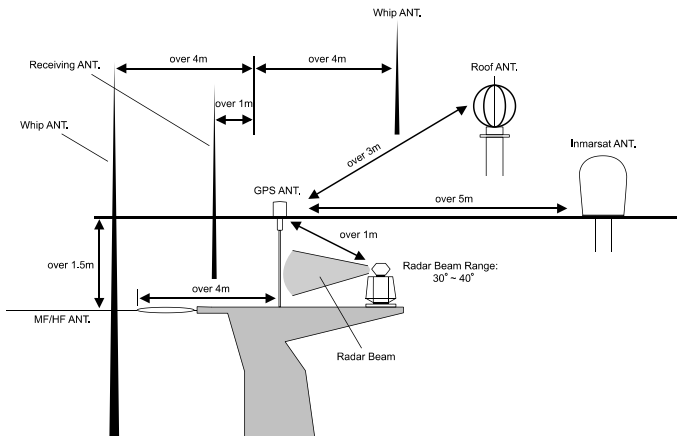

※ Warning: Not less than 0.5m away from the metal surface.

If the environment can't be satisfied from 1 to 10, have NO. 10 satisfied and consider the others.

|| Installation of the Transducer

A careful installation will assure maximum performance from your new SVS-560/460 series.

Display Unit Location

Select a location for your Display unit that provides easy viewing from all likely operator's positions. The display unit is designed to be mounted on either a console or from an overhead surface. The Display unit is also designed for flush mounting using six threaded holes on the rear panel. Locate the display in an area with protection from the elements and avoid direct sunlight on the viewing window. Also, consider access to the rear panel of the unit for connecting power and cables to the various remote sensors. The mounting surface must be flat and solid to support the unit and prevent vibration. There should be access to the inside of the surface to permit through bolt fastening for the mounting bracket.

Display Unit Installation

Temporarily install the mounting bracket on the SVS-560/460 series display unit and place the unit at the selected location.



The Display unit is unstable when the mounting bracket is not secured. Hold the unit in place at all times.

Check the suitability of the location and make any adjustments. When all is satisfactory, use the holes in the mounting bracket as a guide and mark the holes locations on the mounting surface.

Installation of the Transducer

Drill a 1/4 in. diameter hole at each marked location. Mount the Display unit bracket using bolts through the mounting surface. Place large flat washers on the opposite side of the mounting surface from the bracket and then install lock washers and nuts. Tighten securely.

Install the display unit into the mounting bracket. Check alignment and operation of the pivots and security of the mounting. Make any adjustments necessary to prevent binding and assure even meshing of the pivot locking washers. It is advised to remove the display unit and store it in a safe place to prevent damage during the rest of the installation process.

Power Connection

Power is supplied to the Unit through a connector on the rear panel of the display unit.

Route the power cable from the Unit location to the ship's power distribution panel.

Connect the black wire to a battery negative (-) terminal of the power panel.

Connect the white wire to a fused battery positive (+) terminal of the power panel (12 to 24 Vdc nominal). If a fused terminal is not available, install an in-line fuse holder.

Transducer Connection

There are many transducers available which may be used to expand the capabilities of the **SVS-560/460** Fishfinder Unit. Connectors for these accessories are provided on the rear panel of the Fishfinder Unit.

See table on following page for list of optional transducers

SVS-560/460 Transducer Options			
Model #	Beam Angles	Type	Hole Size
250/50/200ST-CX	45° @ 50kHz 11° @ 200kHz	Plastic transom mount w/ depth, spd, temp.	N/A
1700/50/200T-CX	45° @ 50kHz 11° @ 200kHz	Bronze thru hull depth & temp.	7/8"
500/50/200ST-CX	45° @ 50kHz 11° @ 200kHz	Bronze thru hull depth, speed, & temperature	2"
P319/50/200T-ES	45° @ 50kHz 12° @ 200kHz	Plastic thru-hull flush mount with temp	2"
B-60-0 - CX (for 0° to 7° hull dead rise)	45° @ 50kHz 12° @ 200kHz	Bronze thru Hull, Tilted Element Flush Mount, Depth & Temperature Only	2.375"
B-60-12 - CX (for 8° to 15° hull dead rise)	45° @ 50kHz 12° @ 200kHz	Bronze thru Hull, Tilted Element Flush Mount, Depth & Temperature Only	2.375"
B-60-20 - CX (for 16° to 24° hull dead rise)	45° @ 50kHz 12° @ 200kHz	Bronze thru Hull, Tilted Element Flush Mount, Depth & Temperature Only	2.375"
810-15	15ft Transducer Extension Cable		
810-30	30ft Transducer Extension Cable		
Digital A Cable	Adapter Cable for use with All Dual Freq. CVS-106 Versions		

*All SVS Transducers come with a Conxall (Model #CX-128) 8 pin Conn. On the end of the transducer cable

Installation of the Transducer

Installing the Transducer Cable-

Thru-Hull and transom-Mount Installation

cable, with the connector attached, is supplied with the transducer. During the installation, **do not cut the transducer cable or remove the connector**. Do not try shorten or splice the cable. The transducer cable includes several wires, along with shielding and insulation. If the cable is cut, it cannot be repaired. (Cutting the cable will also void the warranty.) During installation, if you need to drill any holes for the cable, they must be large enough to accept the connector (.3/4" or 19mm) This will allow you to complete the installation without cutting the wire.

1st) For a transom-mount installation - Route the cable up and over the top edge of transom. Secure the cable using cable clamps. (These clamps are available from your local marine equipment supplier.) If you do not want to expose the cable on the deck, you may drill a new hole (3/4" or 19mm) through the transom for the cable. (Remember - this hole must be large enough to accept the cable with the connector attached. Do not cut the cable!) To seal the opening, use a feed-thru cap where the cable passes through the transom.

2nd) For either type of installation - Run the cable through the interior of the boat.

3rd) Be careful not to tear the cable jacket when passing it through bulkheads and other parts of your boat. Secure the cable in place using Nylon Wire Ties. Coil the extra cable and tie it out of the way.

4th) If transducer cable is not long enough, 15 & 30 foot extension cables are available from SI-TEX When you attach the extension cable, be sure that the connections are tight and watertight. Use Dow Corning DC-4 or an equivalent sealing compound to protect the connector assemblies.

Installation of the Transducer

Installing the Power Cable-

1st) The 6-foot power cable supplied with the display unit should reach the source of DC power. Connect the power leads directly to the main battery isolation switch or breaker, or route the power leads to the DC power distribution panel. At the power source, connect the red wire to the positive terminal (+), and the black wire to the negative terminal (-). The negative terminal may also be called "ground" or "earth." (The display unit is internally protected if you accidentally reverse the polarity of the power wires.)

2nd) Attach the red or positive wire to a 5 amp circuit breaker. If the unit is connected directly to the boat's battery, include a 2amp in-line fuse. (In-line fuses are available at most marine supply stores.)

3rd) To prevent any interference or electrical noise, separate the Fishfinder power wiring as much as possible from other devices. See the section on "EMC Installation Guidelines."

4th) If you need to extend the power wiring by more than 10 feet, use a larger wire size. This will allow the wires to deliver the correct voltage in spite of the longer wire distance. For runs of 20 to 35 feet, use #14 AWG wire. If you need to extend the power wiring, be sure all electrical connections are solid and durable. Insulate all connections using heat-shrink tubing or electrical tape. You may use crimp connectors or a terminal strip, but be sure to use good-quality marine-grade parts.

5th) Plug in the power cable at the rear of the display unit.

6th) When you press the Power button, the display unit should turn on. If the unit will not turn on and you suspect that you may have reversed the power connections, check the DC power lines all the way back to the battery. If the polarity is not correct, reconnect the leads properly and try again. (The display unit is internally protected if you accidentally reverse the polarity of the power wires.)

Installation of the Transducer

Installing a Thru-Hull Transducer

Follow these instructions if you are installing the thru-hull transducer.

1st) Once you have decided where to install the transducer, drill the hole for the part. Begin by drilling a small pilot hole (1/8" or 3mm) from the inside of the hull. (This small hole can be filled easily if the mounting location is not suitable.) Before you drill the hole, be sure you will be able to reach the large nut on the top of the transducer, once it has been mounted. Also be sure there will be enough clearance for the cable. If there is a strake or other feature on the hull, drill from the outside of the hull instead.

2nd) Drill a larger hole from the outside of the hull using the appropriate size hole saw or paddle bit for the selected transducer.

3rd) Uncoil the transducer cable. Remove the large hex nut from the housing and slide it over the end of the cable.

4th) Thread the cable through the hole to the inside of the hull. Never pull or carry the transducer in place by pulling on the transducer cable.

5th) Apply a thin layer of sealant (1/8" or 3mm) to the transducer between the upper flat surface of the transducer and the faring block. Use a high quality marine sealant suitable for underwater use. (Caution do not use 3M 5200) Also apply a thin layer up the side walls. this should cover all of the threads where the part will touch the hull material, plus an additional 1/4"(6mm). This will seal the threads for the large hex nut.

6th) Push the transducer housing (with the sealant applied) into the hole from the outside of the hull. Twist the housing slightly to squeeze out any excess sealant and to get a good seal. Be sure that the transducer is aligned so that the correct part of the unit is toward the bow of the vessel. Hold or prop the transducer in place temporarily.

Installation of the Transducer

7th) Go to the inside of the hull and slide the hex nut over the end of the cable. Fit the hex nut over the end of the transducer and tighten it. (On a vessel with a wooden hull, do not tighten the nut completely right away. Allow some time for the wood to swell after the vessel is put in the water. Be sure that the correct end of the transducer is pointing forward see Picture 1-1

8th) Remove any excess sealant from the outside of the unit to assure smooth water flow over the face of the transducer.

9th) As soon as the boat is placed in the water, check for leaks. Check again within 3 to 5 hours. (You may not be able to see a small leak right away.) If there are any leaks, you must repeat the installation procedure.

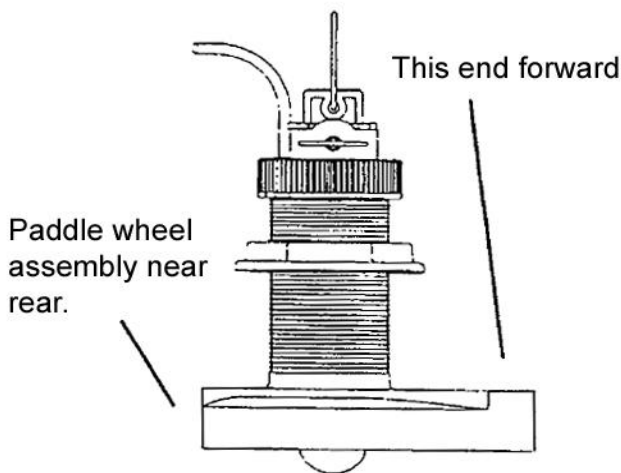

<Picture 1-1>

Installation of the Transducer

Positioning the Transom-Mount Transducer

Follow these instructions if you are installing the transom-mount transducer.

Begin by finding the best location for the mounting bracket. Here are the rules:

If your boat has one propeller (outboard or inboard-outboard), mount the transducer about 18" (455mm) to the side of the centerline of the boat. See Picture 1-2. Choose the side that is on the down stroke of the propeller. (This is usually the starboard side of the boat.) This will reduce any interference caused by air bubbles.

If your boat has twin propellers (outboard or inboard-outboard), place the transducer near the centerline of the boat.

If the propeller can be turned to steer the boat, allow at least 2" (50mm) beyond the swing radius of the propeller. This will prevent the propeller from damaging the transducer when it is turned.

Do not mount the transducer behind any hull fittings, intakes, or other parts which extend from the hull. These may cause turbulence or air bubbles.

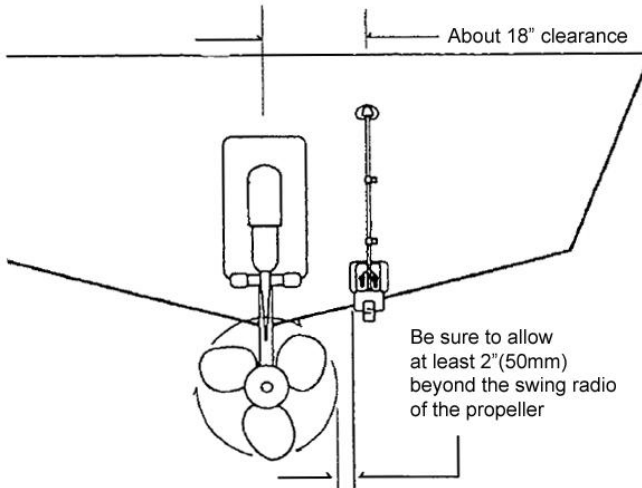

<Picture 1-2>

If the boat will be carried on a trailer, be sure the transducer will not hit any rollers, bunks or fittings on the trailer.

Installation of the Transducer

Mounting the Transom-Mount Transducer

Follow these instructions if you are installing the transom-mount transducer.

1st). On a boat with a fiberglass hull, the leading edge of the transducer should extend 1/8" (3.2mm) to 1/4" (6mm) below the bottom edge of the hull. See picture 1-3. On an aluminum hull, the transducer should extend a bit more - 1/4" (6mm) to 3/8" (9mm). If the boat will be operated at high speeds, the transducer may be mounted closer to the centerline of the hull.

2nd) The lower surface of the transducer should tilt down toward the rear at a slight angle (2° to 5°). The mounting bracket includes a wedge. Depending on the angle of the transom on your boat, you may need this wedge to get the correct angle for the bottom of the transducer.

3rd) Looking at the rear of the boat, be sure the bracket is vertical (perpendicular to the water line).

4th) Hold the bracket (and the wedge, if used) against the transom and trace the position of the screw slots.

5th) Remove the bracket. The screws in the outer slots should be placed about 1/4" (6mm) up from the bottom of each slot. The screw in the center slot should be placed 1/4" (6mm) down from the top. (This will allow you to adjust the bracket up or down a bit.)

Drill pilot holes 3/4" (19mm) deep. Use a 9/64" (3.5mm) drill bit. To prevent drilling too deeply, wrap masking tape around the drill bit about 7/8" (22mm) from the tip. Drill in only as far as the tape marker. If you are attaching the bracket to a fiberglass hull, you can minimize any surface cracking of the gel coat. Before drilling each pilot hole, drill a shallow hole (chamfer) at each location about 1/16" (1.5mm) deep. Use a 1/4" (6mm) drill bit.

6th) Attach the bracket to the hull using the pinhead screw with flat washers. Before you tighten the screws, apply a good-quality marine sealant to the pilot hole. This will protect the hull from water penetration. Do not tighten the screws completely yet.

Installation of the Transducer

7th) Tilt the transducer in the brackets until it is positioned as illustrated in Picture 1-3

8th) Once the bracket is in the correct position, you can tighten the screws.

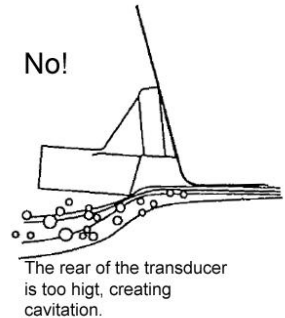
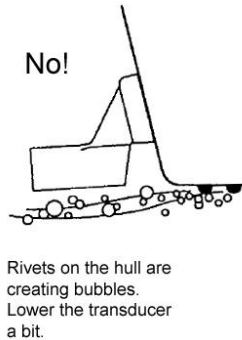
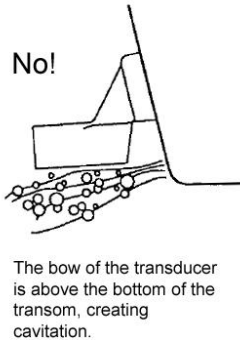
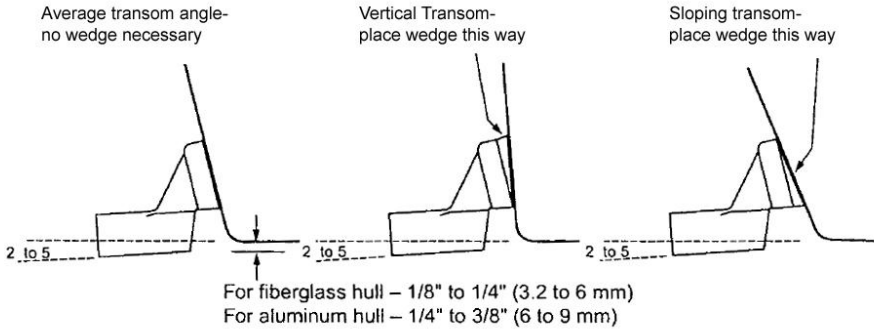









<Picture 1-3>









Getting Started

1. The Keyboard

1.1. Model:SVS-560C/SVS-460C

KEY	Description
	use this to select menu items, move the on-screen cursor
	Rotary: use this to select menu items Button: push the end of the everything to confirm a selection or entry
	Change the chart of scale
	Open the menu
	Select the Goto function
	Select the configuration & modification you wish.
	Select the activated section
	Press to place a waypoint and access the waypoint option. Press and hold to place a MOB marker at your current position.
	Power "on/off", brightness and day/night mode .

1.2 Model: SVS-560CF/SVS-460CF

KEY	Description
	use this to select menu items, move the on-screen cursor and Choosing the frequency
	Rotary: use this to select menu items and Adjustment of gain & STC level with turning. Button: push the end of the everything to confirm a selection or entry
	Change the chart of scale and Setting up the depth range
	Open the menu
	Select the Goto function
	Select the configuration & modification you wish.
	Select the activated section
	Press to place a waypoint and access the waypoint option. Press and hold to place a MOB marker at your current position.
	Power "on/off", brightness and day/night mode.

1.3. How to use



(Fig.1.1)

1.3.1. Turn on

 Switch on.

1.3.2 Turn off

 Keep pressing to switch off.

1.3.3. Adjust brightness

 Pressing (Fig.1.1) and controlling the brightness with [◀] [▶].

1.3.4. Use day/night mode

 Pressing (Fig.1.1) and changing the day and night with [▲][▼].

2. Specification of the connectors

TRANSDUCER

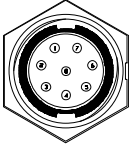

NO	COLOR	NAME
1	Black	SPD_PULSE
2	Red	SPD_VCC
3	White	TD1
4	Green	TD_GND
5	Gray	TD2
6	Yellow	TEMP_VCC
7	Brown	TEMP_SIG
8	Blue	SPD_GND

PWR/NMEA

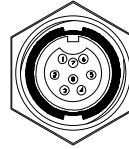

NO	COLOR	NAME
1	Black	GND/COMMON
2	Red	PWR(12~36V)
3	White	INPUT1 +
4	Green	INPUT1 -
5	Gray	OUTPUT2 +(AIS)
6	Yellow	OUTPUT1 +
7	Brown	INPUT2 -(AIS)
8	Blue	NC

3. Screen Overview

3.1. Chartplotter page

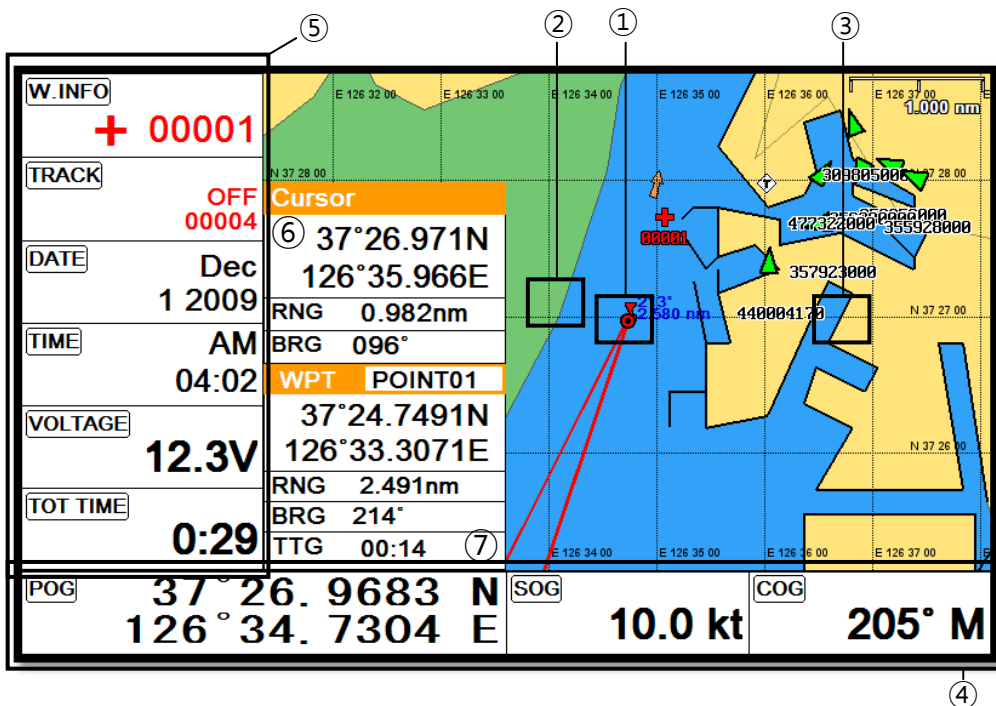

①	Vessel icon	The present position.
②	Cursor	Showing the cursor icon.
③	AIS target	Showing the received AIS target.
④	Databar	Showing various data on the top or bottom.
⑤	Sidebar	Showing various data on the right or left.
⑥	Cursor INFO	The information of the cursor.
⑦	WPT INFO	The information of WPT such as LAT/LOT, Range, etc.

3.2. Fishfinder page

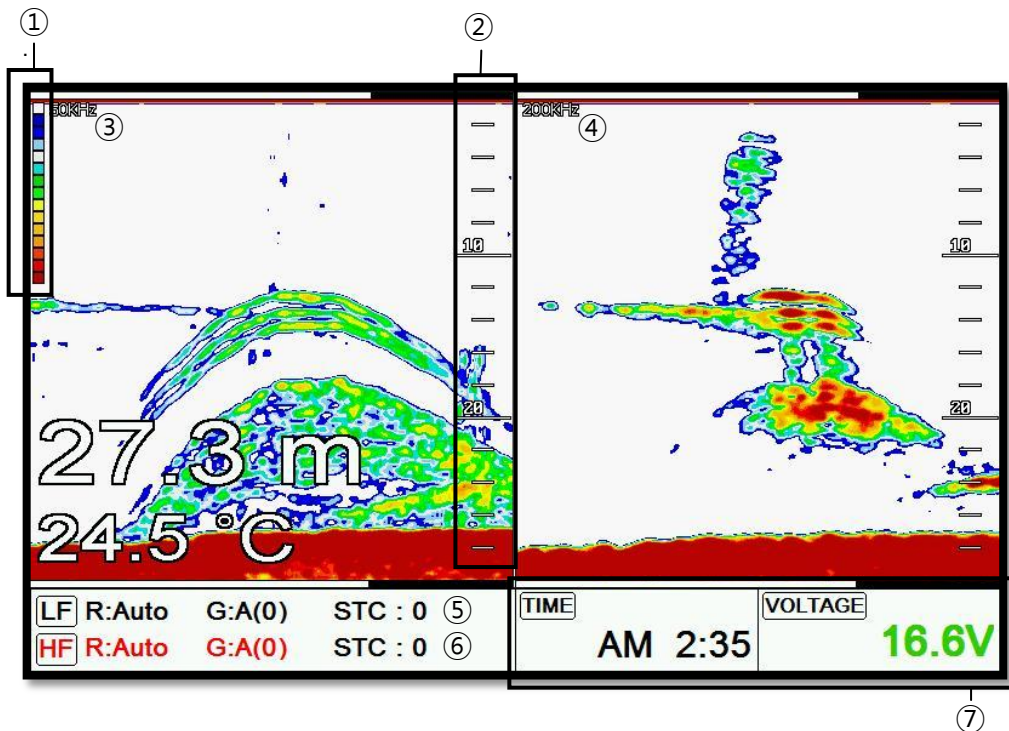

①	Palette	Showing the chosen colors.
②	Depth bar	The current depth.
③	Low Frequency	Showing 50KHz.
④	High Frequency	Showing 200KHz.
⑤	LF INFO	The information of Low Frequency, 50KHz.
⑥	HF INFO	The information of High Frequency, 200KHz.
⑦	Databar	Showing various data on the top or bottom

3.3. Navigation Data page

3.3.1. Navigation Data Type1

37° 25. 6046 N			
126° 34. 1458 E			
SOG	COG	WPT	
10.0 kt	205° M	37° 26. 7810 N 126° 34. 7830 E	
DEPTH	TEMP	WPT NAME	XTE
27.4 m	24.5 °C	POINT00	L 0.30 nm

3.3.2. Navigation Data Type2

POS		WPT	
37° 25. 1559 N 126° 33. 9535 E		37° 24. 9870 N 126° 33. 8420 E	
TRACK	WPT INFO	WPT NAME	BRG
OFF 00000	+ 00000	POINT00	207°
DATE	TIME	RNG	TTG
Dec 1 2009	AM 04:10	0.190 nm	00:01
DEPTH	TOT TIME	XTE	VOLTAGE
27.4 m	1:37	R 0.00 nm	12.2V

3.4. Highway page

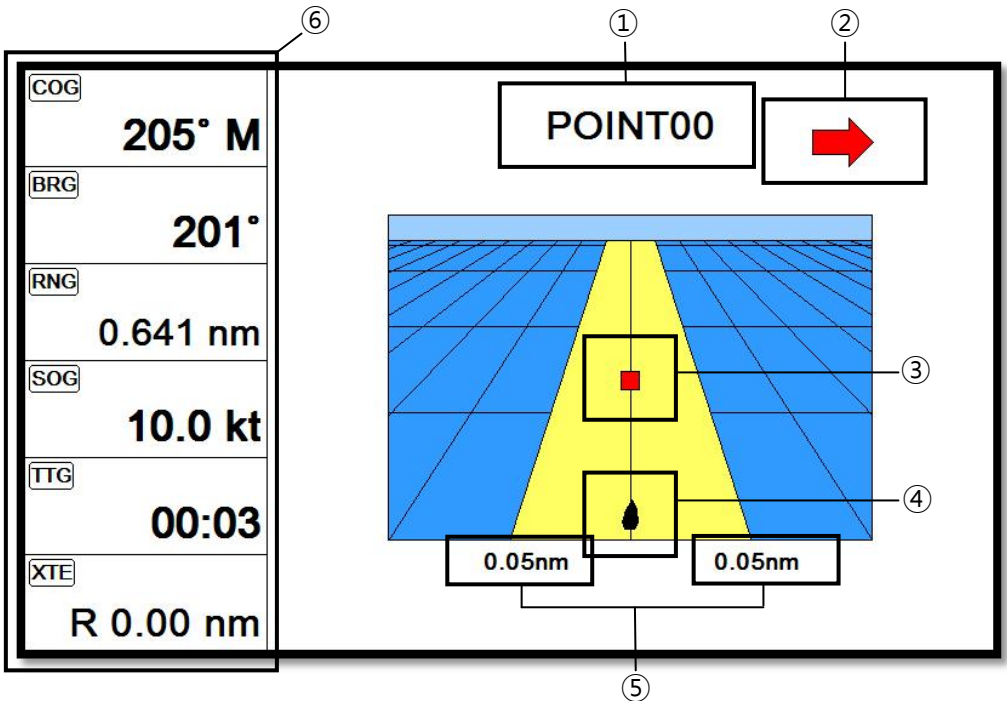

①	WPT name	The current WPT name.
②	Direction of steer	The best direction of the steering.
③	WPT icon	The remaining distance of the WPT.
④	Vessel	The out of the range from the best.
⑤	XTE Range	The range of the XTE alarm.
⑥	Navigation Data	The information of the various data.

3.5. Steering page

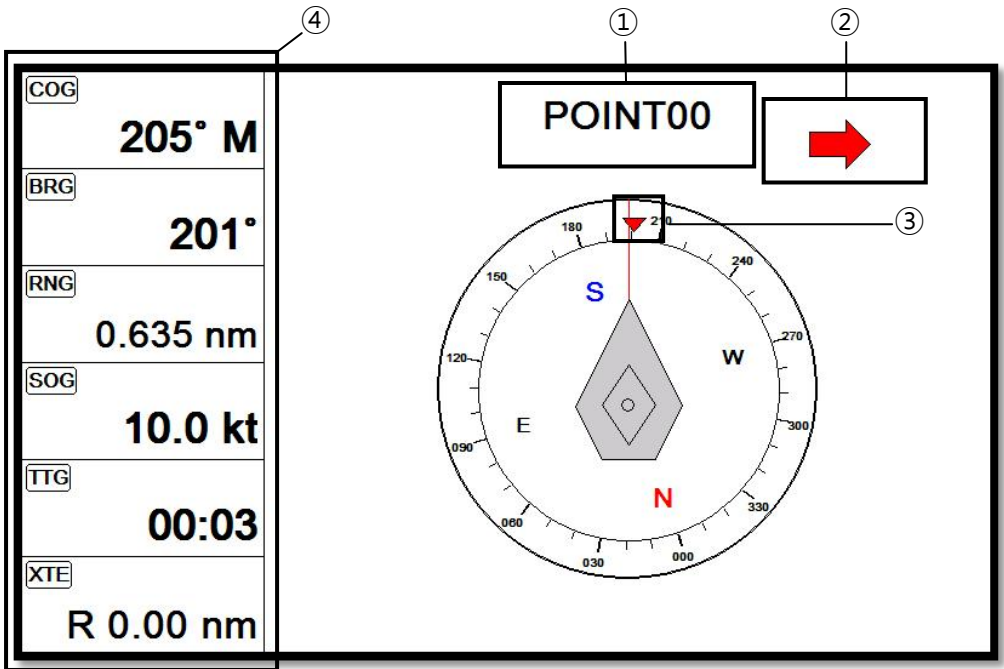

①	WPT name	Name of the WPT.
②	Direction of steer	The best direction of the steering.
③	WPT icon	Showing the WPT and the bearing
④	Navigation Data	Information of the various data.

3.6. GPS Status page

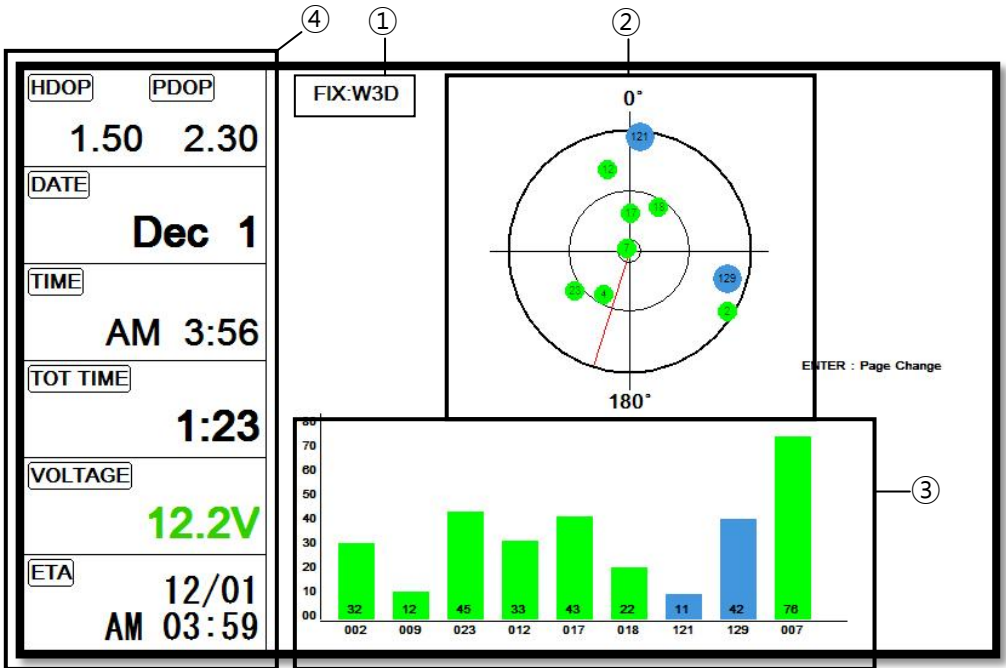

①	Receiver status	The current GPS status.
②	Position of SAT.	Position of the satellites.
③	SNB Graph	Showing the WPT and the bearing.
④	Navigation Data	Information of the various data.

* Colors of the GPS status

- Black:** Tracked, but no signal
- Blue:** Tracked, but not used, Satellite
- Green:** Used Satellite
- Light Blue:** SBAS Satellite

4. Databar

Showing various data on the top or bottom.

POS	37° 27.6640 N	SOG	10.0 kt	COG	205° M
	126° 35.0287 E				

4.1. Mode

► [MENU]->Advance->Setup->Customizing->Databar->Mode

Databar has three meanings as below.

4.1.1. Fix Mode 1

Showing the largest LAT/LOT.

37°26.248 N	126°34.421 E
-------------	--------------

4.1.2. Fix Mode 2

Showing the LAT/LOT, SOG, COG and userdata.

37°27.7498 N	SOG	10.0 kt	TRACK OFF 00000	Dec 1 2009 AM 02:33
126°35.656 E	COG	205° M	W/M + 00000	PDOP 2.30

4.1.3. Customizing

Showing various data as what the user wants.

► [MENU]->Advance->Setup->Customizing->Databar->Edit

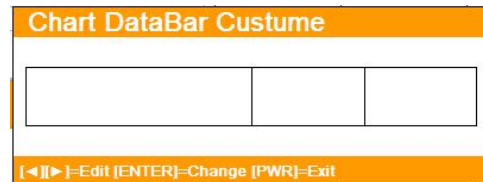

(Fig.1.2.1)

The databar is coming as (Fig.1.2.1), and choose the frame with [◀||▶].

Four frames are available as (Fig 1.2.2).

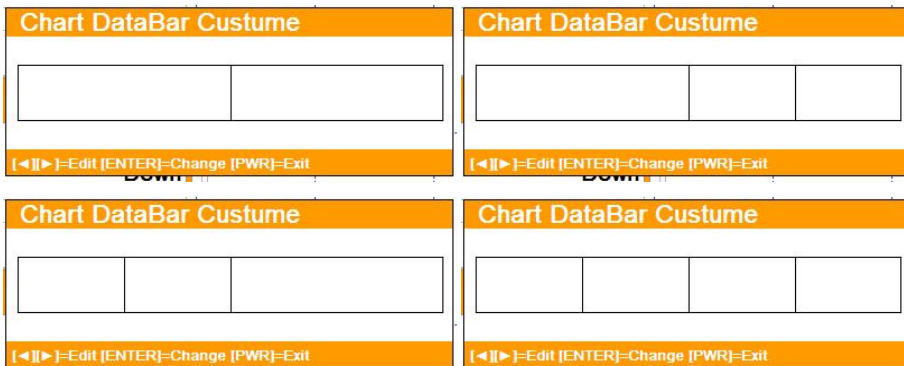

(Fig.1.2.2)

When choosing the frame, setting up in each box as (Fig.1.2.3).

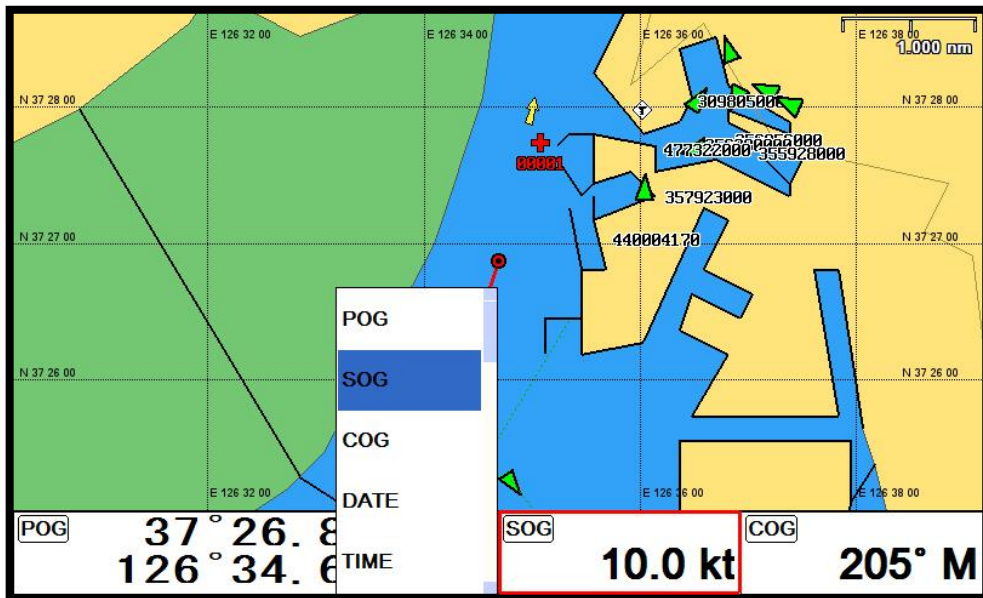

(Fig.1.2.3)

When finishing the set up, press **PWR** (PWR) to exit.

(*Please, refer “Customizing” for further question.)

4.2. Display

► [MENU]->Advance->Setup->Customizing->Databar->Display

Setting the databar, "Shown/Hidden".

4.3. Position

► [MENU]->Advance->Setup->Customizing->Databar->Position

Setting the databar position on the top or bottom.

5. Cursor

5.1. Calling the cursor

Press [◀][▶][▼][▲] on the chart, the cursor comes out.

5.2. Moving

Press [◀][▶][▼][▲], the cursor is moving to the direction.

Press [◀][▼] together, the cursor is moving to "↙".

Press [▶][▼] together, the cursor is moving to "↘".

Press [◀][▲] together, the cursor is moving to "↖".

Press [▶][▲] together, the cursor is moving to "↗".

5.3. Removing the cursor

Press  to remove the cursor.

5.4. Cursor information window

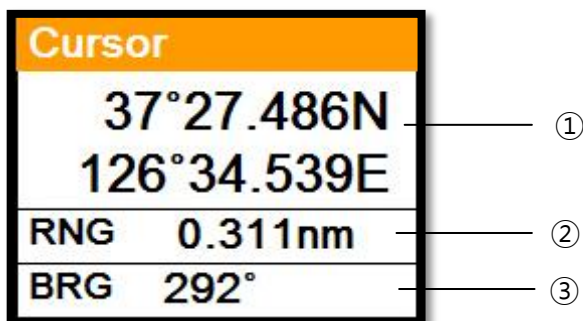

①	Latitude/Longitude	LAT/LON of the cursor.
②	Range	Distance between the cursor and the present position.
③	Bearing	Bearing from the present position to the cursor.

5.5 . Cursor information window shown/hidden

► MENU->Advance->Setup->Customizing->INFO window->Cursor

Cursor information window "Shown/Hidden".

6. Page

► [PAGE]

Choosing the various pages that set up pages or customized.

Move the red box to choose the page.

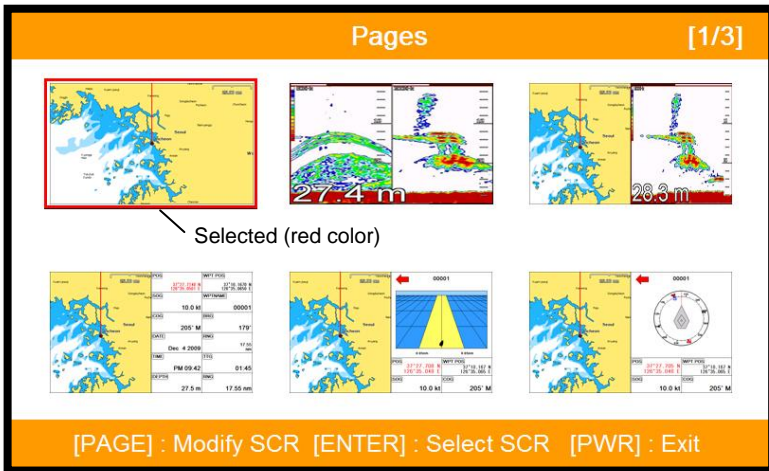

(Fig.1.3)

6.1. Page mode

► [MENU]->Advance->Setup->Customizing->Page mode

Two ways to choose the page.

6.1.1. Standard

With seeing the set up page, choosing the page or modifying.

6.1.2. Flip

Showing the set up pages in order.

(* In Flip mode, modifying the order is available.)

6.2. Modify

After choosing the page in (Fig1.3), keep pressing **PAGE** until the window comes out as

(Fig.1.3.1).

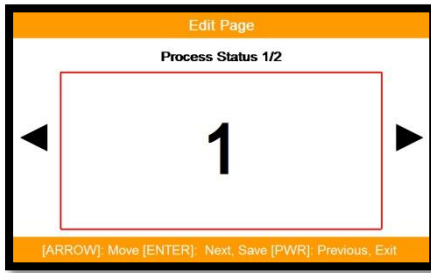

(Fig.1.3.1)

Choosing the frame with [◀][▶].

Two frames as (Fig 1.3.2).

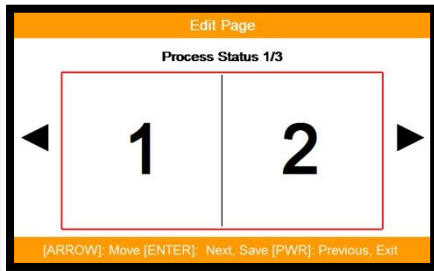
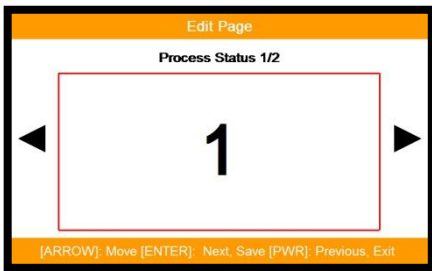

(Fig.1.3.2)

After choosing the box, choose the page as (Fig.1.3.3).

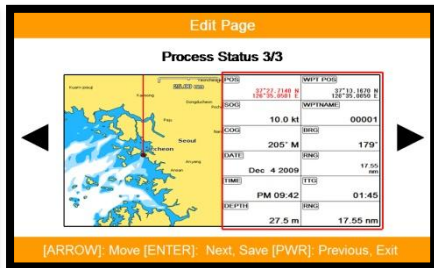
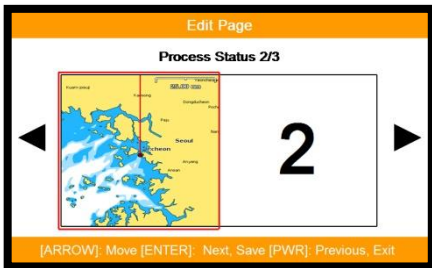

(Fig.1.3.3)

When finishing, press **PWR** (⏻) to exit.

7. Active

► [ACTIVE]

When pressing [ACTIVE], the red box moves to to chartplotter or fishfinder.

(*All key functions change to chartplotter or fishfinder)

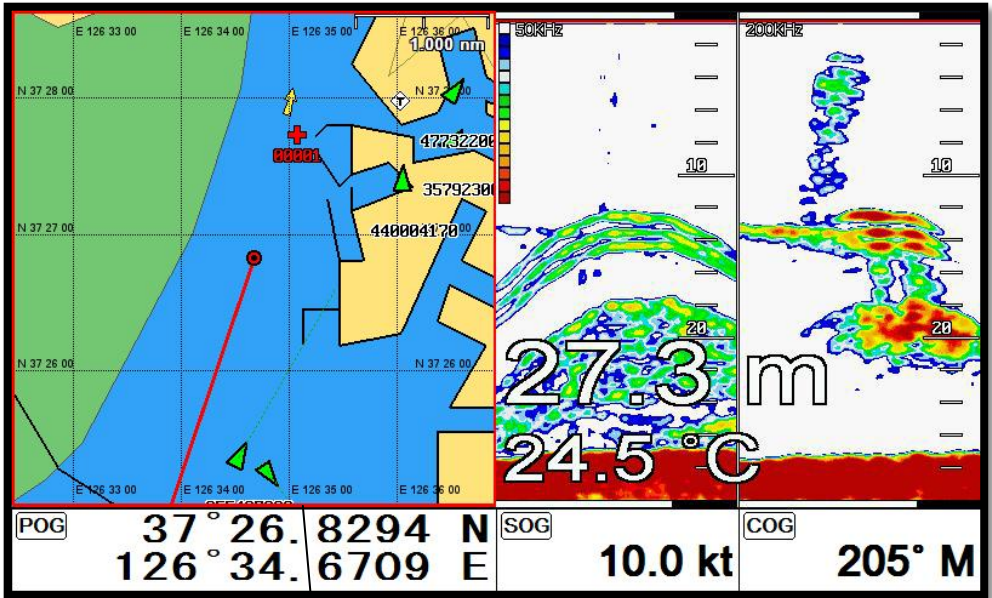

Selected (red color)

8. Sidebar

Databar on the right or left.

(*Sidebar is available only in the full chartplotter and the full fishfinder)

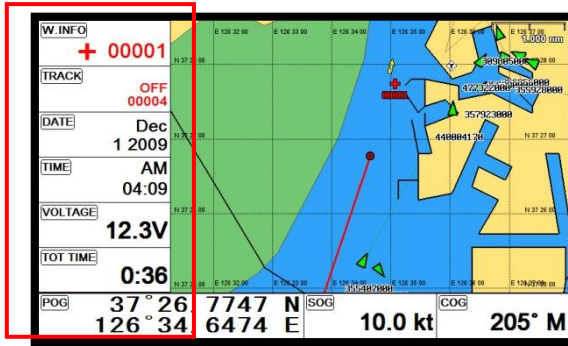

8.1. Display

► [MENU]->Advance->Setup->Customizing->Sidebar->Display

Choosing the sidebar, “Shown/Hidden”.

8.2. Position

► [MENU]->Advance->Setup->Customizing->Sidebar->Position

Choosing the sidebar on the right or left.

8.3. Edit

► [MENU]->Advance->Setup->Customizing->Sidebar->Edit

After finishing all of them as (Fig.1.4), press **PWR** (⏻) to exit.

(*Please, refer “Customizing” for further question)

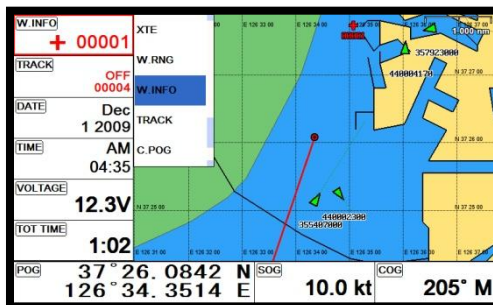

(Fig.1.4)

9. Navigation Data

Navigation data is available in Navigation data page, Steering page, Highway page as (Fig.1.5).

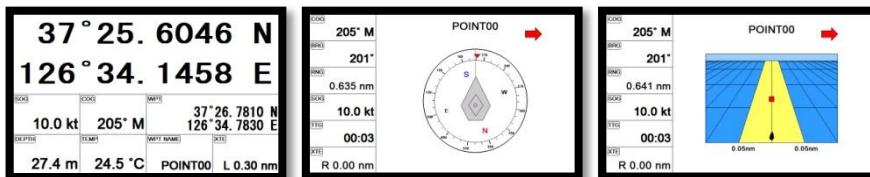

(Fig.1.5)

9.1. Type

► [MENU]->Advance->Setup->Customizing->Navigation data->Type

Two types of Navigation data page.

9.1.1.Type1

Large LAT/LOT as (Fig.1.6.1).

(*Editing the LAT/LOT is unavailable)

9.1.2. Type2

Various data as (Fig.1.6.2).

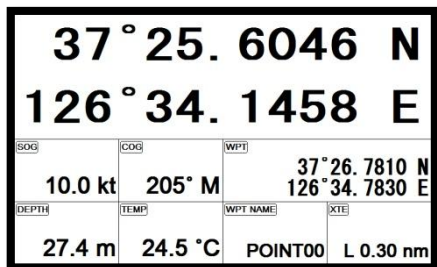

(Fig.1.6.1)

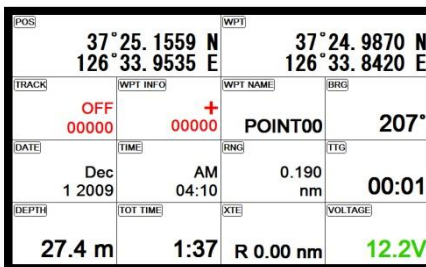

(Fig.1.6.2)

9.2. Edit

(*If there is no navigation data on the page, editing the navigation data is unavailable)

► [MENU]->Advance->Setup->Customizing->Navigation data->Edit

After finishing as (Fig.1.6.3), press **PWR** to exit.

(*Please, refer “Customizing” for further question)

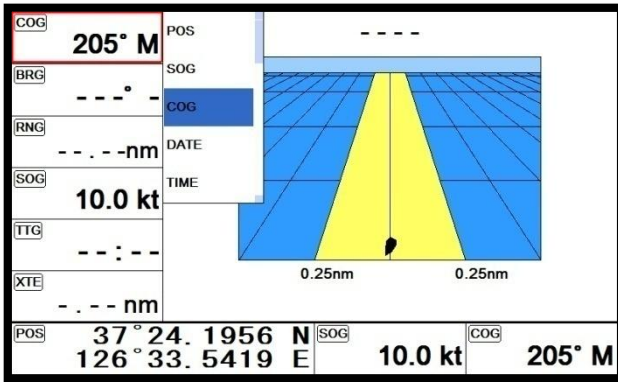

(Fig.1.6.3)

10.MOB

If a person or missing an object overboard and you need to get present position, use the MOB function.

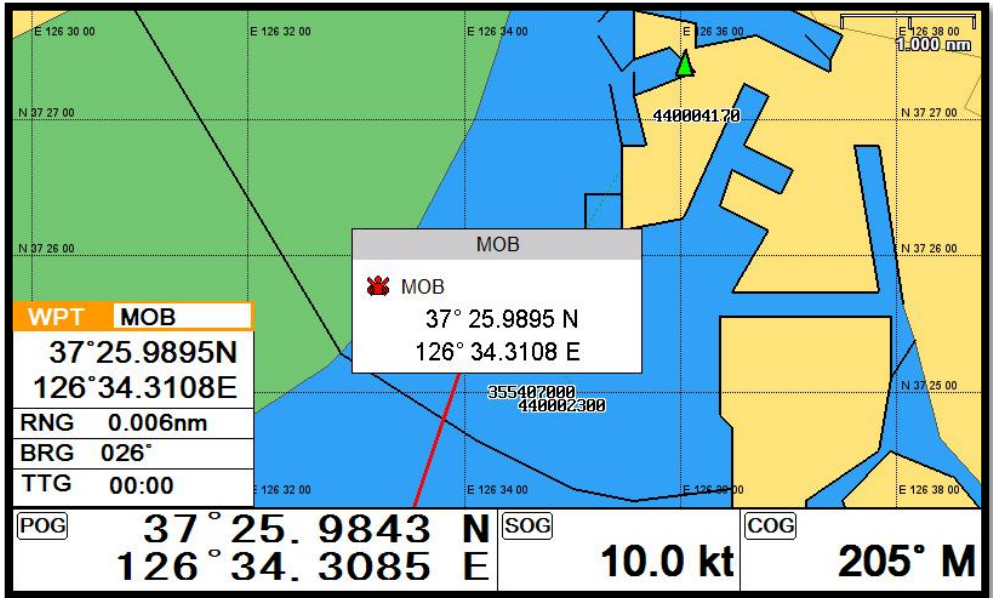

10.1. Inputing

Keep pressing until the window comes out as [Fig.10.1] and then “MOB” comes out with alarm.

10.2. Exiting the alarm

When alarming, press and you may exit the alarm.

10.3. Removing

While MOB is setting, press again and you may remove the “MOB”.

(*MOB is not stored in the flash memory)

11. MircoSD

Inserting the micro SD as (Fig.1.7).

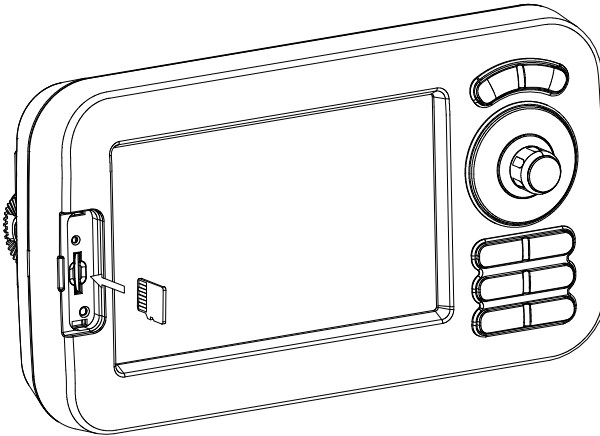

(Fig.1.7)

12. Save Userdata

►[MENU]->Userdata->Save Userdata

Userdata is stored in the external Micro SD. So if you want to save the userdata, a micro SD must be inserted in the slot.

(*Userdata is in “..\HY\UserData”)

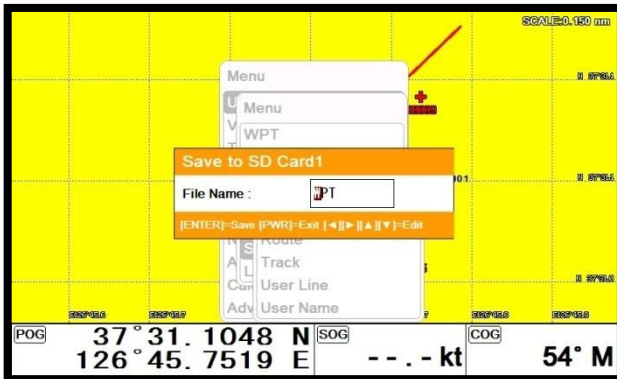

12.1. WPT

WPT can be stored in a micro SD.

When storing, give it a name and you will be able to store many WPT' in the micro SD.

12.2. Route

Route can be stored in a micro SD.

When storing, give it a name and you will be able to store many routes in the micro SD.

12.3. Track

12.3.1. Type1

Track can be stored in a micro SD.

When storing, give it a name and you will be able to store many tracks in the micro SD.

12.3.2. Type2

Track can be stored in a micro SD.

Index will be a standard in Type2. After choosing the index, stored it.

12.4. User Line

User Line can be stored in a micro SD.

When storing, give it a name and you will be able to store many user lines in the micro SD.

12.5. User Name

User Name can be stored in a micro SD.

When storing, give it a name and you will be able to store many user names in the micro SD.

13. Load Userdata

► [MENU]->Userdata->Load Userdata

Userdata loads from the stored micro SD. If you need to load the userdata, the stored micro SD must be inserted in the slot.

(*Userdata is in “..\HY\UserData”)

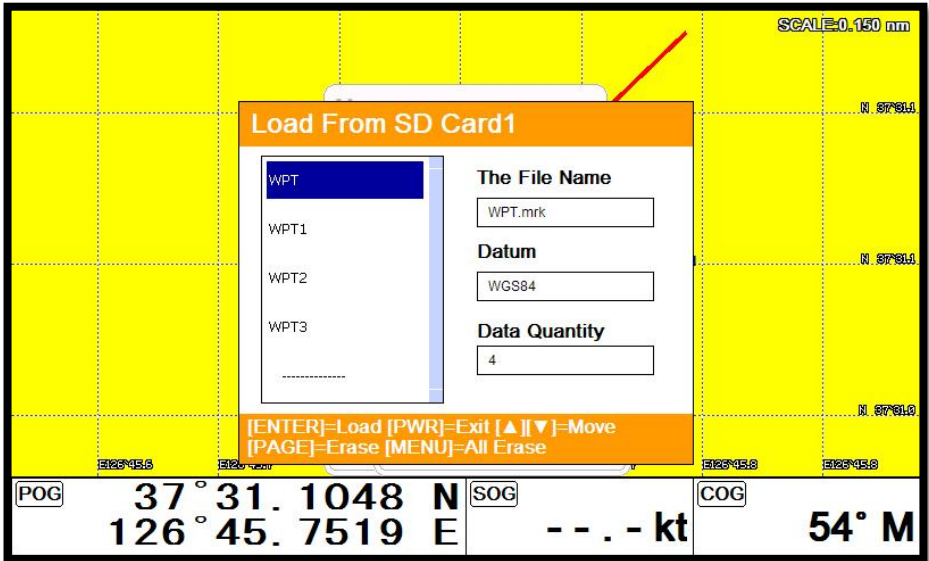

13.1. WPT

WPT loads from the stored micro SD.

All of WPT in the micro SD show on the list. Choose one of them and it will show.

There are two ways to load WPT.

First, showing the stored WPT as well as the existing on the screen. After loading the stored, you will see the window and press **[MENU]**.

Second, showing only stored WPT. After loading the stored, press [ENTER].

13.2. Route

Route loads from the stored micro SD.

All of route in the micro SD show on the list. Choose one of them and it will show.

13.3.Track

13.3.1. Type1

Track loads from the stored micro SD.

All of track in the micro SD show on the list. Choose one of them and it will show.

13.3.2. Type2

Track loads from the stored micro SD.

Index will be a standard in Type2. After choosing the index, stored it.

13.4. User Line

User line loads from the stored micro SD.

All of user line in the micro SD show on the list. Choose one of them and it will show.

13.5. User Name

User name loads from the stored micro SD.

All of user name in the micro SD show on the list. Choose one of them and it will show.

|| Chartplotter getting started

1. GOTO

1.1. Goto type1

1.1.1. Setting

► [MENU]->Navigation->Goto type->type1

Setting GOTO with creating a route at the same time.

Move the cursor to the position where you want to go and press [ENTER].

(*While navigating, WPT can be added in the route)

1.1.1.2. Exit/Store

If you want to exit, remove the cursor and press [GOTO]. The window to store or not shows up.

Choose one of them and you will exit.

(*If you have one WPT in the route, the WPT will be stored. If you have more than two, all of WPT and the route will be stored together)

1.2. Goto type2

1.2.1. Setting

► [MENU]->Navigation->Goto type->type2

Direct GOTO where you want to go. Only one destination is available.

1.2.2. Exit/Store

If you want to exit, remove the cursor and press [GOTO]. The window to store or not shows up.

Choose one of them and you will exit.

1.2.3. Changing

While navigating, you can change a new destination. Move the cursor and press [GOTO] for the new destination.

2. WPT

2.1. List

► [MENU]->Userdata->WPT->List

Editing, creating, erasing and navigating are available on the WPT list.

WPT LIST

Page 1 ① Selected(blue color)

00001	-----	-----
00002	-----	-----
00003	-----	-----
-----	-----	-----
-----	-----	-----

Latitude/Longitude ⑤

37° 27. 6180 N
 126° 34. 8920 E

⑥ Depth

0m

⑦ BRG

14°

⑧ RNG

1nm

② **WPT Name**

00001

③ **Symbol**

+

④ **Color**

Date & Time ⑨

12. 01. 2009 AM 02:33

[ENTER]=Edit [+]=Add [-]=Erase [MENU]=Sort
 [GOTO]=Goto [PAGE]=All Erase [◀][▶]=Move

①	List	Showing all of the stored WPT.
②	Name	Name of the WPT.
③	Symbol	Symbol of the WPT.
④	Color	Color of the WPT.
⑤	Latitude/Longitude	LAT/LOT of the WPT.
⑥	Depth	Depth of the WPT.
⑦	Bearing	Bearing between the WPT and the present position.
⑧	Range	Distance between the WPT and the present position.
⑨	Date & Time	Date and time of the WPT when stored

2.2. Setting the WPT symbol

► [MENU]->WPT Symbol

- 49 -

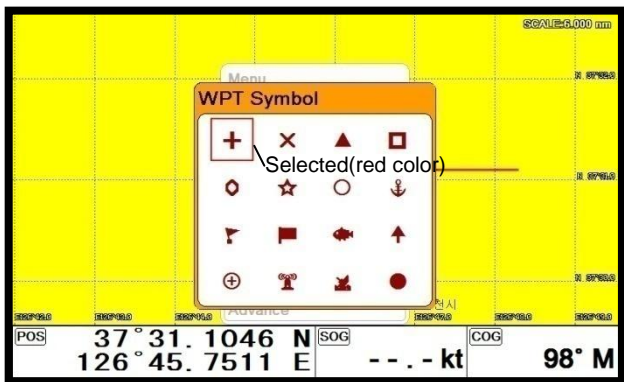

Choose the symbol and press [ENTER].

The chosen symbol will show when inputting WPT.

2.3. Setting WPT Color

► [MENU]->WPT Color

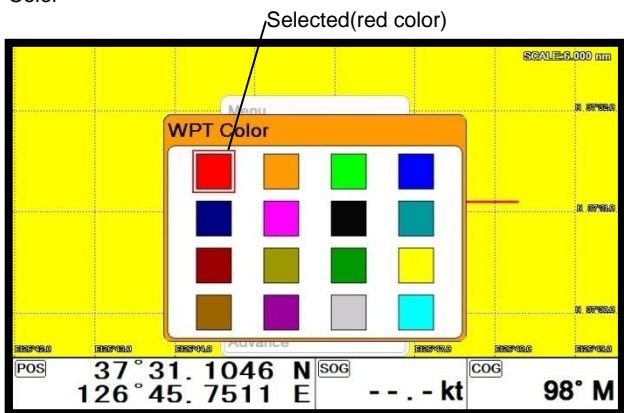

Choose the color and press [ENTER].

The chosen color will show when inputting WPT.

2.4. Creating

2.4.1. Creating on the list

► [MENU]->Userdata->WPT->List->[+]

Adding WPT with pressing .

(*When adding, LAT/LOT show the present position and current symbol/color show for the WPT)

2.4.1. Inputting on the chart

Call the cursor and move the position where you want, and press **WPT** (with cursor icon) .

(*The current symbol/color show for the WPT)

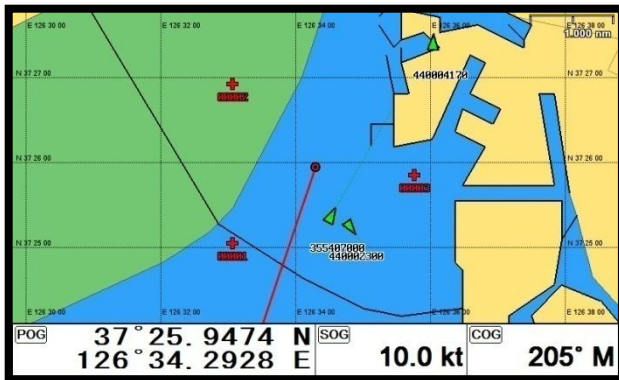

2.5. Erasing

2.5.1. Erasing on the list

► [MENU]->Userdata->WPT->List->[-]

Choose the WPT you want to erase and press **-** .

2.5.2. Erasing on the chart

Call the cursor and put it on the WPT, and press [ENTER].

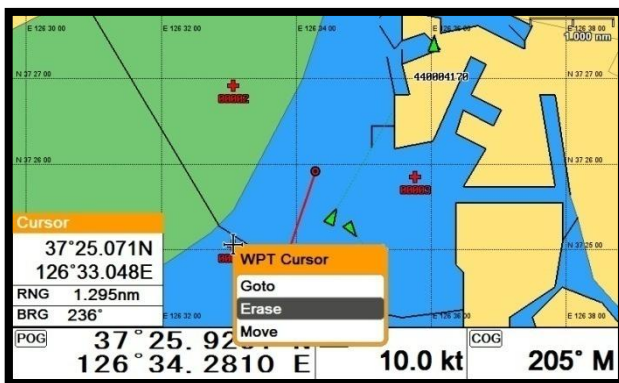

2.6 Erasing all of WPT

► [MENU]->Userdata->WPT->List->[PAGE]

On the WPT list, press **PAGE** .

2.7. Moving the WPT

1. Call the cursor and move it on the WPT, and press [ENTER].

2. Choose "Move".

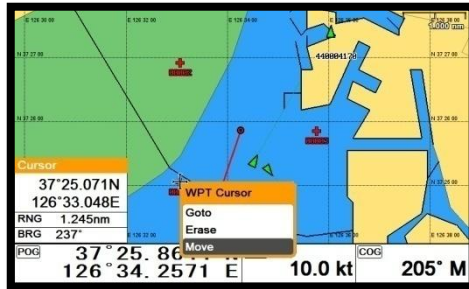

3. Move the WPT to the position where you want to move, and press [ENTER].

2.8. Navigating

2.8.1. Navigating on the list

► [MENU]->Userdata->WPT->List->[GOTO]

Choose the WPT on the list and press **GOTO** .

2.8.2. Navigating on the chart

Call the cursor and move it on the WPT, and press [ENTER]. Choose "GOTO" to start.



2.9. Sorting

► [MENU]->Userdata->WPT->List->[MENU]

Sorting the order of WPT on the list.

WPT LIST

Page 1

00001	-----	-----
00002	-----	-----
00003	-----	-----
-----	-----	-----
-----	-----	-----

Latitude/Longitude

37° 27. 6180 N
126° 34. 8920 E

Depth BRG RNG

0m	235°	0nm
----	------	-----

WPT Name Symbol Color

00001	+	■
-------	---	---

Date & Time

12. 01. 2009 AM 02:33

Sort by [MENU]=Name [+] =Recent [-] =Old
[GOTO]=Symbol [PAGE]=Color

2.10. Editing

► [MENU]->Userdata->WPT->List

Editing the WPT on the list.

WPT LIST

Page 1 WPT Selected(Blue color) Latitude/Longitude

00001	-----	-----
00002	-----	-----
00003	-----	-----
-----	-----	-----
-----	-----	-----

37° 27. 6180 N
126° 34. 8920 E

Depth	BRG	RNG
0m	15°	1nm

WPT Name **Symbol** **Color** **Date & Time**

00001

+

12. 01. 2009 AM 02:33

[◀][▶]=[▲][▼]=Move [ENTER]=Select / Input
[PWR(⏏)]=Cancel / Exit

Edit Selected(green color)

1. Choose the WPT as the blue and press [ENTER].
2. Choose the item as the green and you may begin to edit.
3. After finishing, press PWR(⏏) to exit.

3. Route

3.1. List

►[MENU]->Userdata->Route->List

ROUTE LIST

Page 1 ①

ROUTE001	-----	-----
-----	-----	-----
-----	-----	-----
-----	-----	-----

④ Total distance

2.1nm

⑤ Display

Shown

Date & Time ⑥

2009.12.01 AM 02:34

② Route Name

ROUTE001

③ Number of WPT

3

Start WPT ⑦

Name: 00004

LAT/LON
37°27.2040 N
126°34.3670 E

End WPT ⑧

Name: 00006

LAT/LON
37°28.3540 N
126°35.5650 E

[ENTER]=Edit [+]=Add [-]=Erase [MENU]=Sort
[GOTO]=Goto [PAGE]=Detail [◀][▶]=Move

①	List	Showing the stored WPT
②	Name	Name of the route
③	Number of WPT	Number of WPT in the route
④	Total distance	Total distance of the route
⑤	Display	Shown/Hidden the route on the chart
⑥	Date & Time	Date and time of the WPT when stored
⑦	Start WPT	The beginning of the route
⑧	End WPT	The end of the route

3.2. Route detail

► [MENU]->Userdata->Route->List->[PAGE]

ROUTE DETAIL

Page 1 ^①

00004	-----	-----
00005	-----	-----
00006	-----	-----
-----	-----	-----
-----	-----	-----

Latitude/Longitude ^⑤

37° 27. 2040 N

126° 34. 3670 E

Depth ^⑥

27m

BRG ^⑦

227°

RNG ^⑧

0nm

WPT Name ^②

00004

Symbol ^③

Color ^④

Date & Time ^⑨

2009. 12. 01 AM 02:34

[ENTER]=Edit [MENU]=Add Saved WPT [+]=Add New WPT
[-]=Erase [GOTO]=Find [◀][▶]=Move

①	List	Showing the stored WPT
②	Name	Name of the WPT
③	Symbol	Symbol of the WPT
④	Color	Color of the WPT
⑤	Latitude/Longitude	LAT/LOT of the WPT
⑥	Depth	Depth of the WPT
⑦	Bearing	Bearing between the WPT and the present position
⑧	Range	Distance between the WPT and the present position
⑨	Date & Time	Date and time of the WPT when stored

- 56 -

3.3. Creating

Two ways to create route

The first uses "GOTO type1" and the second is "Creating new route" on the list.

3.3.1. Using "GOTO"

Use "GOTO type1" and create a route. Press [ENTER] to start.

Press **GOTO** to exit and choose "Store" if needed.

3.3.2. Creating new route on the list

► MENU->Userdata->Route->List

Press ***** on the list to create a route.

The screenshot shows a screen titled "ROUTE LIST" with a yellow header. The screen is divided into several sections:

- Page 1**: A label with an arrow pointing to the "Selected(Blue color)" text.
- ROUTE001**: A list of routes with "ROUTE001" highlighted in blue.
- Total distance**: A box containing "2.1nm".
- Display**: A box containing "Shown".
- Date & Time**: A box containing "2009. 12. 01 AM 02:34".
- Start WPT** and **End WPT**: Two columns of data for the start and end waypoints.
- Route Name** and **Number of WPT**: Two boxes containing "ROUTE001" and "3" respectively.
- Legend**: A yellow bar at the bottom with the following text: [ENTER]=Edit [+]=Add [-]=Erase [MENU]=Sort [GOTO]=Goto [PAGE]=Detail [◀▶]=Move

Start WPT	End WPT
Name: 00004	Name: 00006
LAT/LON 37°27.2040 N 126°34.3670 E	LAT/LON 37°28.3540 N 126°35.5650 E

3.4. Edit

► MENU->Userdata->Route->List

Choose the route on the list to edit.

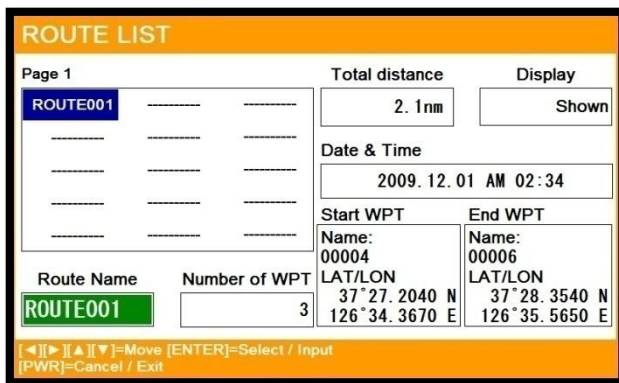

3.5. Detail edit

► [MENU]->Userdata->Route->List->[PAGE]

Choose the route on the list and press **PAGE**. The window of Route detail shows.

3.5.1. Adding WPT

Two ways to add WPT

3.5.1.1. Adding the stored WPT

► [MENU]->Userdata->Route->List->[PAGE]->[MENU]

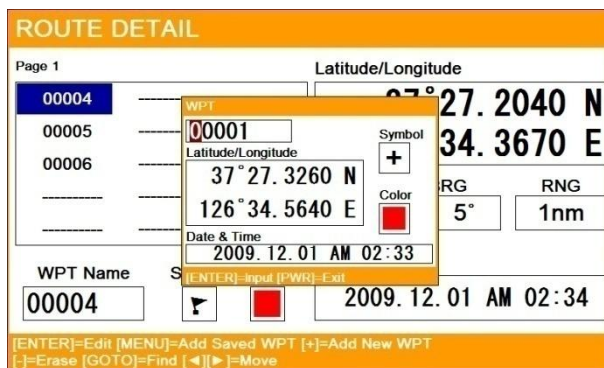

(Fig.2.1)

Press **MENU** on the Route detail and you may add the stored WPT as (Fig.2.1).

3.5.2.1. Adding new WPT

Press  on Rout detail and you may add new WPT.

3.5.3. Erasing WPT

Choose the WPT and press  .

3.6. Navigating

► [MENU]->Userdata->Route->List->[GOTO]

Choose the route on Route list and press  .

3.7. Erasing

Choose the route and press  .

4. Track

The maximum point is 50,000.

Two ways to manage the track. The first is to manage the total 50,000 points by colors. The second is to divide 50,000 points in five rooms, and you can store 10,000 points for the maximum in each room.

Tracking has two types, "by time and by distance".

4.1. Track on/off

► [MENU]->Track

Shown/Hidden the track.

4.2. Choosing the track

4.2.1. By time

► [MENU]->Userdata->Track->Track Setup->Record Setup->Time

Tracking by the set time.

4.2.2. Setting the time interval

► [MENU]->Userdata->Track->Track Setup->Time Interval

Setting the time interval.

4.2.3. By distance

► [MENU]->Userdata->Track->Track Setup->Record Setup->Distance

Tracking by the set distance.

4.2.4. Setting the distance interval

► [MENU]->Userdata->Track->Track Setup->DIST Interval

Setting the distance interval.

4.3. Setting the thickness

► [MENU]->Userdata->Track->Track Setup->Thickness

Setting the track thickness.

4.4. Track Color

► [MENU]->Track Color

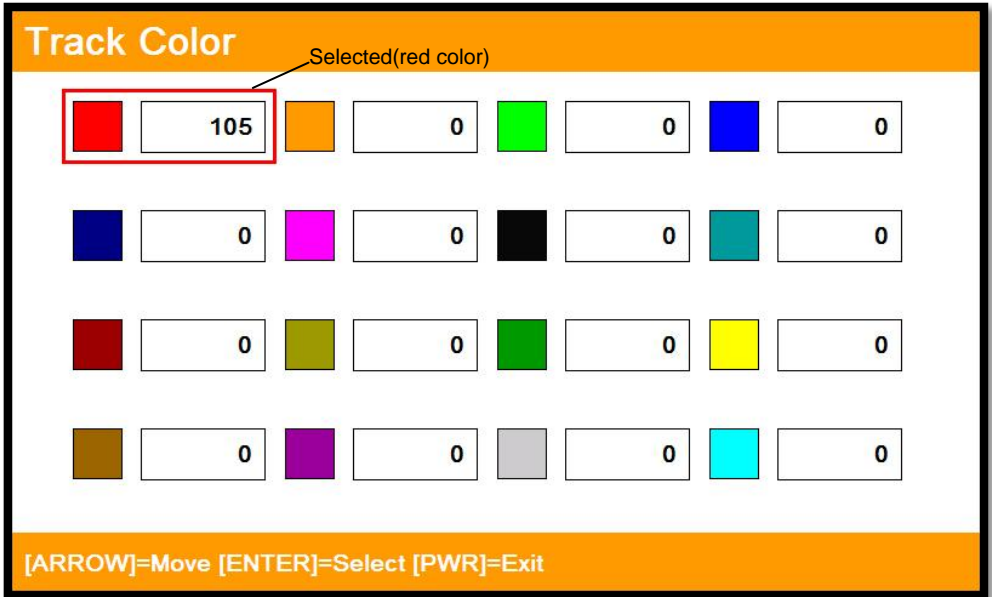

Choose the color and press [ENTER].

(* The number next the color shows the number point of the track color)

4.5. Track type

4.5.1. Type1

► [MENU]->Userdata->Track->Track Setup->Type1

4.5.1.1. Erasing

► [MENU]->Userdata->Track->Erase

Choose the color and press [ENTER].

(*The number next the color shows the number point of the track color.)

4.5.1.2. Erasing all of track

► [MENU]->Userdata->Track->Erase

Press MENU .

4.5.2. Type2

► [MENU]->Userdata->Track->Track Setup->Type2

4.5.2.1. Select index

► [MENU]->Userdata->Track->Select Index

Five rooms in the index. The maximum is 10,000 points in each room.

In Type2, storing, loading and erasing are available to manage in the room.

4.5.2.2. List

Showing the information of each room.

TRACK LIST

<div style="border: 1px solid black; padding: 5px;"> <p style="background-color: blue; color: white; padding: 2px;">TRACK1</p> <p>TRACK2</p> <p>TRACK3</p> <p>TRACK4</p> <p>TRACK5</p> </div>	<p>①</p>	<p>Number of Point ②</p> <div style="border: 1px solid black; padding: 5px; text-align: center;">10</div>	<p>Date & Time ③</p> <div style="border: 1px solid black; padding: 5px; text-align: center;">2009. 12. 01 AM 02:59</div>	
	<p>④</p>	<p>Color ④</p> <div style="border: 1px solid black; padding: 5px; text-align: center; background-color: red;"> </div>	<p>Start Point ⑦</p> <div style="border: 1px solid black; padding: 5px;"> <p>LAT/LON</p> <p style="text-align: center;">37° 27. 0708 N</p> <p style="text-align: center;">126° 34. 7744 E</p> </div>	<p>End Point ⑧</p> <div style="border: 1px solid black; padding: 5px;"> <p>LAT/LON</p> <p style="text-align: center;">37° 27. 0487 N</p> <p style="text-align: center;">126° 34. 7649 E</p> </div>
<p>OnOff ⑤</p> <div style="border: 1px solid black; padding: 5px; text-align: center;"> <p style="margin-top: 5px;">On</p> </div>	<p>Display ⑥</p> <div style="border: 1px solid black; padding: 5px; text-align: center;"> <p style="margin-top: 5px;">Shown</p> </div>			

[ENTER]=Edit [-]=Erase

(Fig.2.2)

①	List	Showing the track room
②	Number of Point	Total track point in the track room

③	Date&Time	Date and time of the track room when stored
④	Color	Color of the track room
⑤	On/Off	선택된 index에 항적 상태를 표시합니다.
⑥	Display	Show/Hidden the track room
⑦	Start Point	The beginning of the track room
⑧	End Point	The end of the track room

4.5.2.3. Erasing

Choose the track room on the list and press .

5. Measuring the distance and bearing

Measuring two points, "A" and "B".

1. Call the cursor and move it on the point, "A".
2. Move the cursor on the point, "B".
3. The cursor windows provides the distance and bearing between A and B.
4. Press **PWR**() to exit.

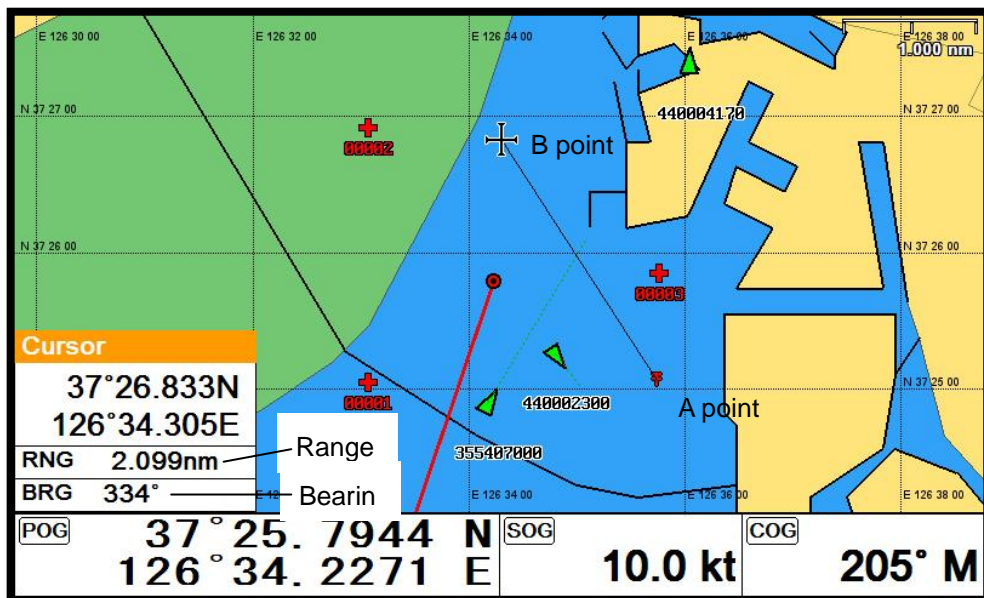

6. User Line

Adding lines directly on the chart.

1. Call the cursor.
2. Press [ENTER] and "User Line" shows.
3. Move the cursor to the beginning point and press [ENTER].
4. Keep moving the cursor and press [ENTER] each time.
5. Press **PWR**() to exit.

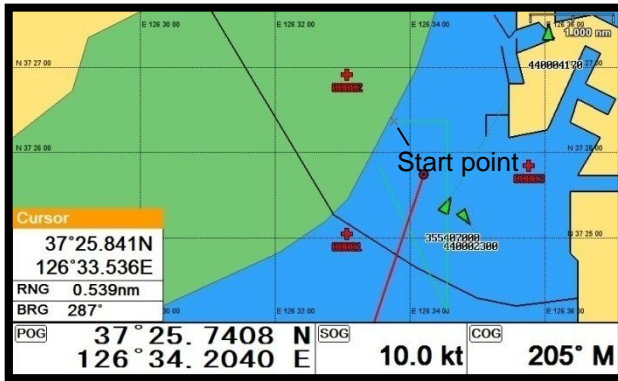

7. User Name

Adding a place name directly on the chart.

1. Call the cursor and move it to the point.
2. Press [ENTER] and choose "User Name".
4. Inputting letters with [◀][▶][▼][▲].
5. Press **PWR** (⊗) to exit.



8. Correction Offset

When the chart position is wrong, making it correct.

1. Call the cursor and move it to the correct position.
2. Press [ENTER] and choose "Correction Offset".

(* The maximum range of Correction Offset is 5nm.)

|| Chartplotter operation

1. Map Orientation

▶ [MENU]->Advance->Map Setup->Map Orientation

1.1. True Motion

▶ [MENU]->Advance->Map Setup->Map Orientation->True motion

The True Motion is in the way the vessel position is presented. In True Motion mode, the vessel icon moves over the map while the map remains stationary.

(* It is not available to operate on Course up and Head up.)

1.2. North Up/South Up/East Up/West Up

▶ [MENU]->Advance->Map Setup->Map Orientation->Up mode

They setting the vessel present position remains fixed in the center of the Main Screen while the map moves under it.

1.3. Course Up

▶ [MENU]->Advance->Map Setup->Map Orientation->Up mode

The Course Up mode screen orientation is determined by whether or not navigation is in progress. During navigation vessel present position is in the center of the Screen and the course line to the destination is straight up. As your present position changes, the map moves under the stationary vessel icon.

(*If navigation is stopped, the Main Screen appears as Head up.)

1.4. Head Up

▶ [MENU]->Advance->Map Setup->Map Orientation->Up mode

For Head Up mode, vessel present position is fixed in the center of the Main Screen and vessel heading is upward. As your present position changes, the map moves under the vessel icon.

2. Map setup

► [MENU]->Advance->Map Setup

2.1. Map orientation

2.1.1. True motion

You can select "True motion"

( The default setting is OFF.)

2.1.2. Up mode

You can select "Map Orientation"

( The default setting is North Up.)

2.2. UserData Display

Setting up shown/hide the user data on the display.

2.3. INFO Display

Setting up shown/hide common item between the HY-MAP and the C-MAP on the display.

2.4. Map scale

Setting up the map scale on the display.

2.5. Palette

It is possible to the palette used to enhance the visibility of the screen depending on the surround light condition. The possible choices are listed in the table below:

2.5.1. Normal

It set the maps are displayed in ordered to use colors as similar as possible to the ones used in the original paper charts.

2.5.2. Sunlight

It is designed to enhance the visibility of the screen when Smart4/5 series is exposed to the sunlight.

The maps are much brighter than in the other displays.

2.5.3. NOAA

Allows setting NOAA paper chart colors presentation.

(*It is available NOAA menu on C-MAP.)

2.6. LAT. Modification

Though GPS information is accurate, there could be an error in the chart at latitude. The error can be modified in the chart latitude modification.

2.7. LOT. Modification

Though GPS information is accurate, there could be an error in the chart at longitude. The error can be modified in the chart longitude modification.

2.8. Chart

Select the chart among HY-MAP,C-MAP and External map.

2.9-1. HY-Map (*Only for *HY-MAP mode.)

2.9-1.1. Depth Line

Setting up 2m,5m,10m,20m,50m of the depth line on the HY-MAP.

2.9-1.2. Rock

Setting up the Rock on the HY-MAP

(☞The default setting is shown.)

2. 9-1.3. Fishing Banks

Setting up the Fishing Banks on the HY-MAP.

(☞The default setting is shown.)

2.9-1.4. Land Color

Select the land color as you want.

(☞The default setting is yellow.)

2.9-1.5. Lighthouse Info

Setting up the Lighthouse on the HY-MAP.

(☞The default setting is shown.)

2.9-1.6. EEZ

Setting up the EEZ line on the HY-MAP.

2.9-1.7. Screen Magnification

Setting up the Screen Magnification on the HY-MAP.

(*MAX Magnification [ON = 0.05nm, OFF = 0.2nm])

2.9-1.8. Zoom mode

Choosing how to zoom-in/out.

(☞The default setting is Turbo.)

2.9-2. C-Map (*Only for *C-MAP mode.)

2. 9-2.1. SAT.Image

Setting up the overlay Satellite Image on the C-MAP.

(☞The default setting is shown.)

2.9-2.2. Font & Symbols

On charts it is possible to set the size of all names and symbols drawn on the charts, selecting between Normal size and Large size.

(☞The default setting is normal.)

2.9-2.3. Mixing Level

When the map coverage at the current zoom level does not fill the entire screen, the chartplotter draws the rest of the map expanding the cartographic information read from, at most, two zoom levels above the current zoom level. For this reason the map is drawn three times; firstly it draws the two levels before the current level and then the current level. The area covered by the cartographic data read from the previous levels is identified by a dotted pattern. When the cursor is moved area not covered by data of the currents level the chartplotter zooms out to the first level covered by cartographic data.

The default setting is ON.

(☞The default setting is on.)

2.9-2.4. Perspective View

Chart data may be projected in perspective mode during navigation. This function allows setting the panoramic View of the chart.

As the upper side of the map is more compressed than the lower side, a wider map area is visible. The perspective view allows showing more chart information immediately ahead and around the cursor.

(☞The default setting is off.)

2.9-2.5. Chart Boundaries

Sets ON/OFF the displaying of the chart boundaries, which represents the boundaries of the charts available on the chartplotter. Selecting Auto instead, if we are in background charts only the first chart

levels contained in the C-CARD are displayed, if we are in a charts level contained in the C-CARD the next four charts level are displayed.

(☞The default setting is auto.)

2.9-2.6. Multi Language

Select language for name of the place, lighthouse or buoy.

(☞The default setting is English.)

2.9-2.7. QuickView

It is available to set up. Place the cursor on buoys or icons on the C-MAP, the information window is shown up automatically.

(☞The default setting is hidden.)

3. Vessel

3.1. Vessel Icon Size

The size of the present position is adjustable from 0 to 9. The biggest size is '0'.

(☞The default setting is 9.)

3.2. Heading Line

The length of the heading line is adjustable from 50 until 300. The bigger number, the longer line. The heading line is used in modes of the true motion and the north up.

(☞The default setting is 270.)

3.3. Vessel style (Circle/Arrow/Vessel)

Select the vessel symbol among Circle, Arrow and vessel.

(☞ The default setting is circle.)

3.4. Orient. Resolution

Sets you preferred Rolling Road Scale.

(☞The default setting is 0.)

4. Cursor Icon

Select the cursor icon between Cross to Arrow.

(☞The default setting is Cross.)

5. Alarm

5.1. Navigation

5.1.1. Arrival Alarm:

When you approach into the waypoint range, it gives you a notice with alarm.

(☞ The default setting is OFF.)

5.1.2. Arrival Radius:

It is to adjust the range of arrival from your waypoint. If you have a route, it changes to the next waypoint automatically.

(☞ The default setting is 0.05nm.)

5.1.3. XTE Alarm:

If you are out of the course, it gives you a notice with alarm.

(☞ The default setting is OFF.)

5.1.4. XTE Radius:

It is to adjust the range of the off course.

(☞ The default setting is 0.25nm.)

5.2. Anchor

5.2.1. Anchor Alarm:

It is necessary when your vessel anchors.

(☞ The default setting is OFF.)

5.2.2. Anchor Radius:

If your vessel is out of the range of the anchor, it gives you notice with alarm.

(☞ The default setting is 0.05nm.)

5.3. Interval

5.3.1. Interval Alarm:

It alarms every time you set.

(☞ The default setting is OFF.)

5.3.2. Interval Time

The time is available from one minute until sixty minutes.

(☞ The default setting is 3 min.)

5.4 User Line

5.4.1. User Line Alarm

It alarms if it breaks into the setting area.

(☞The default setting is OFF.)

5.4.2. User Line Radius

It sets the range of the course alarm.

(☞The default setting is 0.05nm.)



AIS getting started



1. What is AIS?

AIS is an Automatic Identification System. It has been introduced to improve the safety of navigation by assisting in the efficient operation of ship to ship, ship reporting and VTS applications. The system should enable operators to obtain information from the ship automatically, requiring a minimum of involvement of ship's personnel, and should have a high level of availability.

Connecting to the chart plotter an AIS receiver, vessels with AIS transponder within VHF range are displayed on screen giving the skipper or navigator a visual interpretation of the data of nearby vessels. This improves safety, and specifically for collision avoidance reasons.

2. AIS system definitions

CPA	Closest Point of Approach is the closest distance that will be achieved between your vessel and the tracked target, based on your vessel's speed and direction and the target's speed and direction.
TCPA	Time to Closest Point of Approach is the time remaining until the CPA will occur.
Name	Name of ship, 20 characters.
MMSI	Maritime Mobile Service Identity.
MMSI number	A unique 9 digit number that is assigned to DSC radio station. It primarily registers the boat information in the U.S. Coast Guard's national distress database for use in emergency situations.
 Target	It is a vessel equipped with AIS. Information about the targets is being received by AIS Receiver and displayed on the screen.
 Active Target	Target located within the Activation Range. Active target is represented by oriented triangle with COG and Heading vectors. Rate of turn may also be displayed.
 Selected Target	Target selected with cursor. Can view AIS information window.
Dangerous	Target detected by CPA or TCPA Alarm. Dangerous target is Active Target by definition. For better visibility Dangerous Target symbol is changed from basic color

<p>Target</p> 	to red color.
<p>Sleeping Target</p>	Target located outside the Activation Range. Sleeping target is represented by a small oriented triangle.
<p>Lost Target</p> 	When the AIS info is not received from that vessel. The presentation will be marked X on the target.

3. AIS information window

Press [ENTER] key on Target which wants to see. It shows Information of “AIS INFO” window.

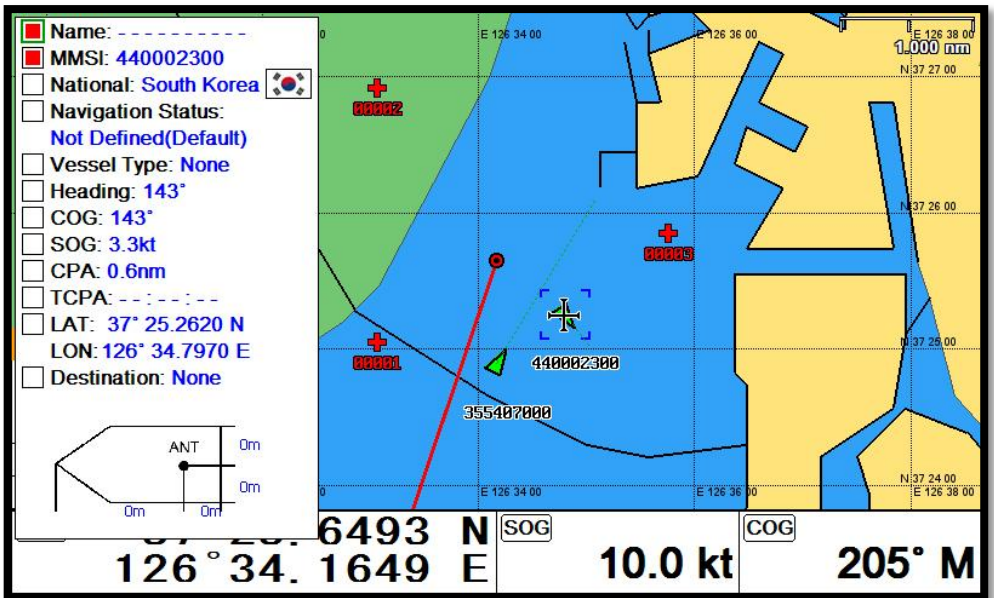

(Fig.3.1)

4. Quick INFO on AIS target

Choose "AIS information window" on (Fig.3.1) and AIS data shows under the AIS target.

(*Up to four kinds of data is available to choose in Quick INFO)

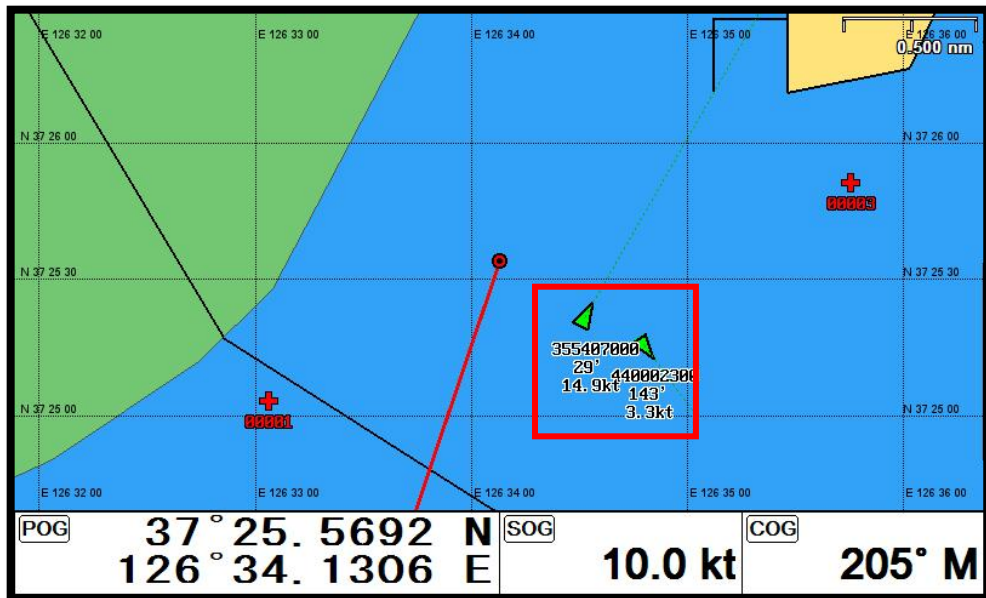

|| AIS operation

▶ [MENU]->AIS

1. AIS On/Off

Turns the display of AIS targets overlay on the screen On or Off.

(☞The default setting is On.)

2. List

2.1. List

Selected(blue color)

AIS LIST		PAGE [1/2]	
① Name	② MMSI	③ Range	④ BRG
-----	256056000	2.3nm	59'
-----	440400150	3.6nm	38'
-----	440003450	2.0nm	13'
-----	356380000	2.1nm	56'
-----	440101050	3.6nm	18'
VICTOR KONETSKY	209110000	3.3nm	19'
-----	440002300	1.7nm	178'
-----	357923000	1.6nm	62'

[ENTER]=Detail [MENU]=Sort [GOTO]=Goto

(Fig.3.2)

①	Name	Name of the AIS target
②	MMSI	MMSI of the AIS target
③	Range	Distance between the AIS target and the present position
④	BRG	Bearing between the AIS target and the present position

2.2. Detail

Choose the AIS target and press [ENTER].

VICTOR KONETSKY

MMSI	IMO	Latitude/Longitude
<input type="text" value="209110000"/>	<input type="text" value="C4UK2"/>	37° 30.1060 N 126° 36.1530 E
Callsign	Type of Vessel	
<input type="text" value="C4UK2"/>	<input type="text" value="None"/>	
Nationality	Nav Status	Destination
<input type="text" value="Cyprus"/>	<input type="text" value="Moored"/>	<input type="text" value="IN'CHON"/>
COG	SOG	ETA
<input type="text" value="187°"/>	<input type="text" value="0.0kt"/>	<input type="text" value="None"/>
Heading	Rate of Turn	
<input type="text" value="0°"/>	<input type="text" value="0.0 degrees/minute"/>	
CPA	TCPA	
<input type="text" value="3.6nm"/>	<input type="text" value="-----"/>	

Dimensions

2.3. Goto

Choose the AIS target and press .

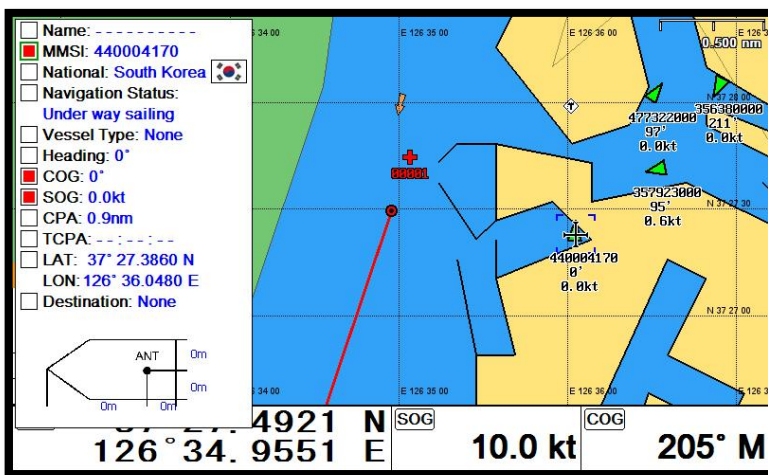

2.4. Sort

Press **MENU** to choose how to sort on (Fig.3.2).

AIS LIST		PAGE [1/2]	
Name	MMSI	Range	BRG
-----	256056000	4.4nm	38°
-----	440400150	6.0nm	30°
-----	440003450	4.4nm	16°
-----	356380000	4.3nm	36°
-----	440101050	6.0nm	18°
VICTOR KONETSKY	209110000	5.8nm	19°
-----	440002300	1.0nm	54°
-----	357923000	3.8nm	36°

Sort by [MENU]=Vessel Name [GOTO]=MMSI Sort
[PAGE]=Range Sort [ACTIVE]=Brg Sort

3. Display radius

Displays range rings centered on your current position.

(☞ The default setting is OFF.)

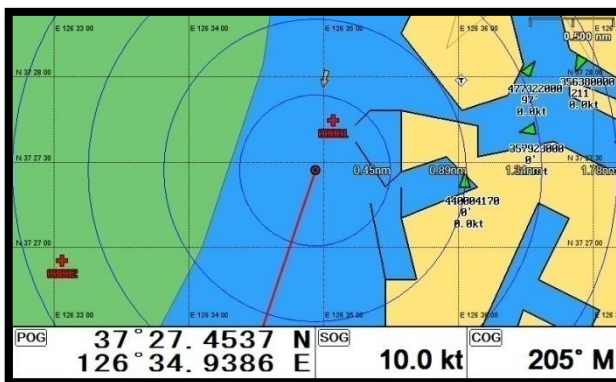

4. AIS target size

Choose the size of AIS target.

(☞ The default setting is Large.)

5. Display vessels by Color

Different types of AIS transmissions can be selected to display different colors of icons on the chart

display.

6. Display vessels by Type

Different types of AIS transmissions can be selected to display different types of icons on the chart display.

7. Filter AIS types

This function allows you to turn on or off reception from different types of AIS transmissions, for instance if you only wanted to view Class B vessels on the chart display then select Class B On and all the others Off.

8. Alarm

8.1. CPA Alarm

The CPA alarm is the closest approach alarm, this allows you to set a distance when the alarm will sound if a vessel comes within that distance .

(☞ The default setting is OFF.)

8.2. CPA Range

The values allowed are from 0.1nm to 10nm.

(☞ The default setting is OFF.)

8.3. TCPA Alarm

The TCPA alarm is the time that a vessel will take to be in the same position as you currently are.

(☞ The default setting is OFF.)

8.4. TCPA Range

The values allowed are from 1 to 50 min.

(☞ The default setting is 1 min.)

8.5. Radius Alarm

When any AIS target breaks into the radius, alarming.

8.6. Radius

The values allowed are from 0.1nm to 10nm.

(☞ The default setting is OFF.)

8.7. Ignore Vessels if Speed Less

If you want the alarms to ignore vessels that are travelling at less than a particular speed then switch ON.

8.8. Speed less than

The values allowed are from 0.1kt to 9.9kt.

9. Set up AIS outs etc

9.1. Mark vessels as lost after

Setting the time of "Lost target".

(☞ The default setting is 7min.)

9.2. Remove lost vessels after

If the updating AIS target is unavailable in the set time, erasing the AIS target on the screen..

(☞ The default setting is 10min.)

9.3. Vessel target

It is available to setup the own vessel's AIS target display on the screen.

(☞ The default setting is On.)

10. Others

10.1. Labels on vessels

This menu controls what details are displayed alongside the vessels icons on the chart display.

10.2. Cursor Box info

When you move the cursor in chart mode over an AIS target a box appears showing details of that vessel.

10.3. Messages List

This window displays lists of specific AIS messages, such as Safety Messages that the unit has received. Scrolling down the list and highlighting a message allows you to see the contents by pressing the [ENTER] key. Whilst in the main list pressing the [MENU] key when a message is highlighted will erase that message, pressing the [▶] [◀] keys will allow you to view any other pages of messages.

★ AIS SART Messages

If an AIS SART message is received it will immediately be displayed on whatever screen you are

viewing. If the “Status” shows “Test” then no further action is required as it is just a test transmission. If the “Status” shows “Active” it will also show the MMSI, Name and position, the SART icon should now be displayed on your chart screen at that location. Monitor your VHF radio on Channel 16 and establish whether any other station has received this SART message, if not take the appropriate action.

10.4. Test View

Showing the text message of SART Message.

( The default setting is Off.)

10.5. Fishing net

10.5.1. Fishing net

Display the programmed Fishing net AIS target.

( The default setting is Off.)

10.5.2. Select name

Program the name of Fishing Net

10.5.3. Alarm

The alarm goes off when no Fishing net AIS target is in setting range.

( The default setting is Off.)

10.5.4. Alarm Radius

Setup the Fishing net alarm range.

( The default setting is 0.05nm.)

#Fishfinder getting started

1. Choosing the frequency

In dual frequency mode, choosing the frequency with [▲][▼].

(*The chosen frequency shows in red)

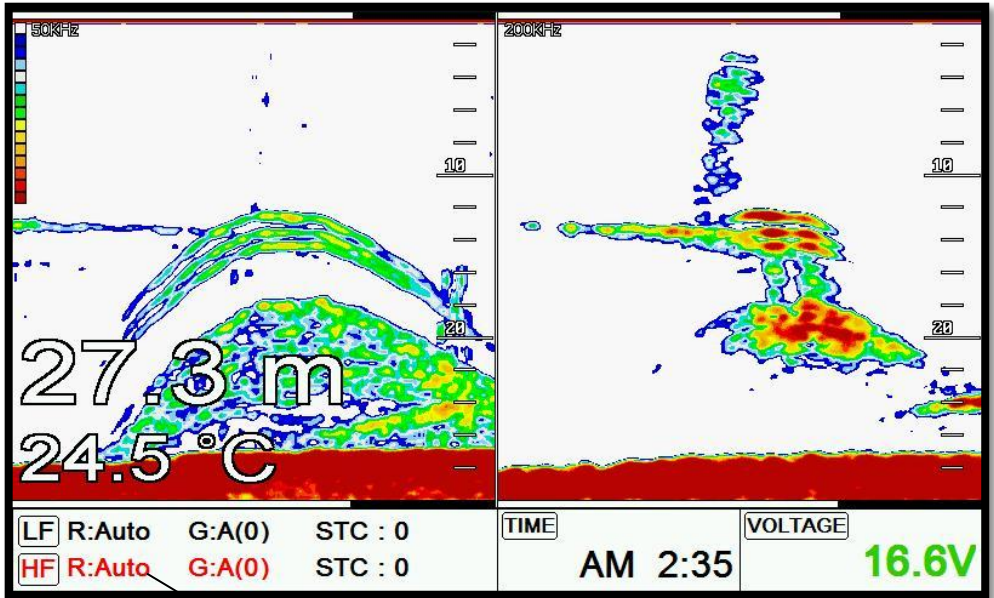

Selected

2. Auto/Manual Gain

Press [ENTER] to choose "AUTO/Manual" of Gain.

3. Gain/STC

Choose "Gain" and "STC" with [◀][▶].

4. Controlling Gain

1. Choose the frequency.
2. Choose the gain.
3. Twisting the rotary key to control the gain.

5. Controlling STC

1. Choose the frequency.
2. Choose the STC.
3. Twisting the rotary key to control the STC.

6. Mode

► [MENU]->Mode

Three kinds in Fishfinder.

6.1. Normal

Normal mode (with Auto Range active) displays the sounder image with the surface at the top of the screen and the sea bottom in the lower part of the screen. The depth scale indicates the depth range appearing in the display. Bottom contours and fish echoes are displayed at the depths where they are detected. If the depth Range is set manually to a value less than actual water depth, sea bottom echoes are not displayed, but all other echoes within the Range setting are displayed.

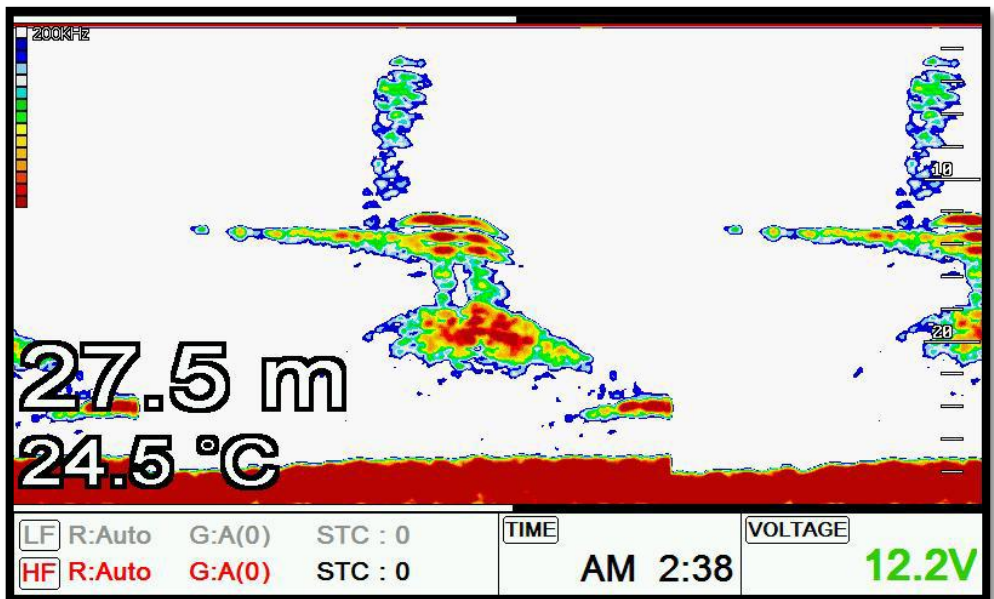

6.2. Bottom Zoom

Bottom Zoom magnifies the sounder display from the sea bottom toward the surface for a short distance. The sea bottom contour is displayed and additional contour lines are added at intervals

above the sea bottom to aid in determining distances of echoes near the bottom. Use the Sounder Menu to set the magnified Bottom Range from 2.5 to 20m (10 to 60ft.). Default setting is 10m (40ft.). If the depth Range is set manually, the setting must place the sea bottom echo in the lower portion of the screen for Bottom Zoom to be effective.

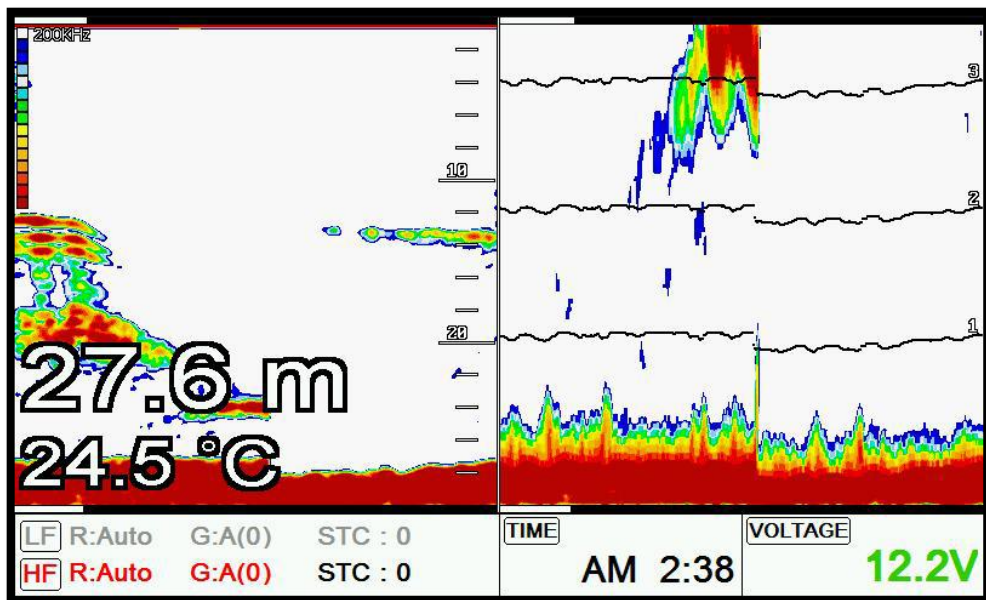

6.3. Bottom Lock

Bottom Lock divides the Fishfinder main screen image for the selected Fishfinder into two sections. The left hand section displays a Normal Mode image. The right hand section of the screen displays the Fishfinder image relative to the sea bottom. The sea bottom appears as a straight line with the Fishfinder image magnified for a short distance toward the surface. A scale appears on the right for estimating distances of echoes near the bottom. Use the Fishfinder Menu to set the magnified Bottom range from 2.5 to 20m (10 to 60ft.). Default setting is 10m (40ft.). If the depth Range is set manually, the setting must place the sea bottom echo in the lower portion of the screen for Bottom Lock to be effective. Fishfinder modes are selectable for single frequency or dual and some functions, for example bottom zoom or lock.

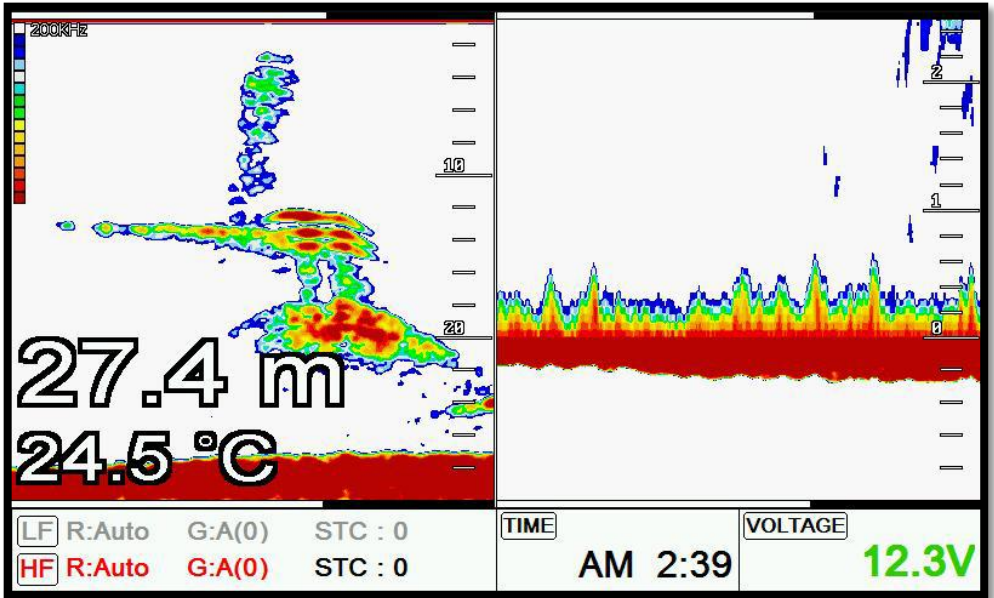

7. VRM

► [WPT]

The VRM (movable marker) shown by the green line can be moved up and down. It is convenient to measure the depth by aligning with the target such as school of fish.

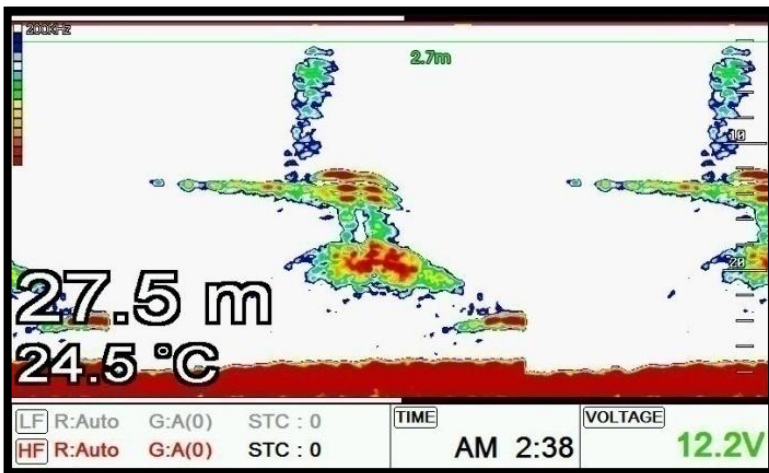

[Fig.2.1]

#Fishfinder operation

1. Menu

▶ [MENU]

1.1. Userdata

It is same as Chartplotter. PLS refer the Chartplotter operation manual.

1.2. Deep Depth Range

Smart4/5 selects the best condition for measuring the depth automatically in the environment of the sea.

(☞The default setting is Auto.)

1.3. Shift

A user selects this function to see more detailed bottom of the sea. When you turn up the shift, the range of Fish finder shall go up from the shift range. For example, if you raise 5m of shift at 20m range, the surface shall start 5m and the bottom range shall be 25m.

(☞The default setting is 0m.)

1.4. Mode

Fish finder modes are selectable for single frequency or dual and some functions.

1.5. Bottom Zoom Range

Select the range of the bottom zoom or lock. It is necessary to modify the bottom.

(☞The default setting is 10m.)

1.6. Fish symbol

Fish symbol with sizes and levels show for targets.

(*Fish symbol is only for reference. This could be different from the real.)

1.7. Fish size

Setup to display of the size of fish.

(☞The default setting is Off.)

1.8. Interference Rejection

When there are another boats around you on sailing, your Fish finder could be disturbed to work. The step of the function is from off to level 2. The bigger number, the more rejection.

(☞The default setting is OFF.)

1.9. Noise Rejection

Your Fish finder could be disturbed by the engine noise. This function can reject the noise from the engine or other machinery instruments.

(☞The default setting is OFF.)

2. Advanced Menu

▶ [MENU] -> Advance

2.1. Display

2.1.1. A-scope

A-scope shows the research under the water by a scope to see the environment under the water.

(☞The default setting is OFF.)

2.1.2. Image Speed:

Select the speed of Fish finder image from 4X until 1/32X.

(☞The default setting is 1X.)

2.1.3. White Line

It is necessary to research a detailed fish on the bottom or a seaweed under the sea. The color of the bottom changes into white or black to see the bottom easier than red.

(☞The default setting is OFF.)

2.1.4.Depth

Shown/Hidden the depth range on the screen.

(☞The default setting is shown.)

2.1.5.Depth Font

Select the depth range font size on the screen.

(☞The default setting is Large.)

2.1.6.TEMP

Shown/Hidden the temperature on the screen.

(☞The default setting is Hidden.)

2.1.1.7.TEMP Font

Select the temperature font size on the screen.

(☞The default setting is Large.)

2.1.1.8. Image Filtering

This function is reduction of the noise.

(☞ The default setting is On.)

2.2. Color

2.2.1. Color Level

This function adjusts the colors. Make it upper level, the color becomes darker.

(☞The default setting is OFF.)

2.2.2. Color Rejection

There are 16 color levels for Fish finder. The color bar is on the left of the Fish finder. If the level is higher, the color of the bar is deleted one by one.

2.2.3. Screen Color

Select the background color of the Fish finder for your convenience.

2.3. Pulse

Select the pulse of the output from the transducer. Levels are among Low, Medium and High, which depends upon the depth. Low is proper to research precise a fish school but it is not suitable to measure a deep depth. High is opposite from Low.

(☞The default setting is Medium.)

2.4. Output Power

Select the output from the installed transducer. Levels are from off to 3. It should be careful about the depth. If you set high level in a shallow depth, the Fish finder screen turns to red. You see nothing expect red on the screen.

(☞The default setting is 3.)

2.5. Alarm

2.5.1. Depth

2.5.1.1. Deep Depth Alarm

It alarms when the set deep depth is out of the range.

(☞ The default setting is OFF.)

2.5.1.2. Deep Depth Range

Setup the range of deep depth alarm

(☞ The default setting is 0M.)

2.5.1.3. Shallow alarm

It alarms when the set shallow depth is out of the range.

(☞ The default setting is OFF.)

2.5.1.4. Shallow range

Setup the range of shallow depth alarm

(☞ The default setting is 0M.)

2.5.2. TEMP(Temperature)

2.5.2.1. High alarm

It alarms when the set high temperature is out of the range.

(☞ The default setting is OFF.)

2.5.2.2. High Range

It alarms when the set high temperature is out of the range.

(☞ The default setting is 0.)

2.5.2.3. Low alarm

It alarms when the set low temperature is out of the range.

(☞ The default setting is OFF.)

2.5.2.4. Low range

It alarms when the set low temperature is out of the range.

(☞ The default setting is 0.)

2.5.3. Fish-School

2.5.3.1. Alarm

It alarms when it detects school of fish.

It will detect school of fish depend on set depth, range and level of the fishfinder.

(☞ The default setting is OFF.)

2.5.3.2. Fish-school Depth

If the alarm is on, It is available to setup the depth of the Fish-school

(☞ The default setting is 10m.)

2.5.3.3. Alarm range

If the the alarm is on, It is available to setup the Range(high) of the Fish-school.(The bar, next of

display is shown)

(☞ The default setting is 50m.)

2.5.3.4. Alarm Interval

If the the alarm is on, It is available to setup the alarm interval.

(☞ The default setting is middle)

2.5.3.5. Color Level

If the the alarm is on, It is available to setup the color level.

It is available to setup the color level

2.6. Water Temp

The error of water temp value can be corrected.

(setting:-10.0 ~ 10.0°C,-10 ~ 10°F)

(☞The default setting is 0.)

2.7. TD Setup

Choosing the frequency of the TD.

2.8. Speed Source

Switch the Sensor/NMEA.

- InsideSensor: Use the built-in speed meter for sensor.
- NMEA: Use the external input value for NMEA.

(☞The default setting is NEMA.)

|| General operation

1.GPS

It is available to control and confirm information in GPS receiver.

1.1. Coordinate System

It sets coordinate system of GPS or Loran.

(☞ The default setting is GPS.)

1.2. Datum

It shows GPS Datum. WGS-84, which is the worldwide standard is only available.

(☞ The default setting is WGS-84.)

1.3. LAT. Modification

There could be a receiving signal error from satellites. If it is on the latitude, modify in the latitude modification.

1.4. LOT. Modification

There could be a receiving signal error from satellites. If it is on the longitude, modify in the longitude modification.

1.5. POG filtering

Step 1(OFF)~59(MAX) the POG Filter. When it is On(over step 1), you can filter the POG of the vessel, to optimize it.

(☞ The default setting is incorrect every the country.)

1.6. COG filtering

Step 1(OFF)~119(MAX) the COG Filter. When it is On(over step 1), you can filter the COG of the vessel, to optimize it.

(☞ The default setting is incorrect every the country.)

1.7. SOG filtering

Step 1(OFF)~119(MAX) the SOG Filter. When it is On(over step 1), you can filter the SOG of the vessel, to optimize it.

(☞ The default setting is incorrect every the country.)

1.8. LAT/LON Unit

It is to select the number of the unit for Lat/Lon.

(☞ The default setting is 4 unit.)

1.9. Receiving Port

It is to select Inter receiver Internal, External and AIS.

(☞ The default setting is Internal.)

2. Setup

It is available to set the menu or units for user's visual confidence.

2.1. Unit

2.1.1. DIST/Speed

Select desired unit of measure for distance and speed. Choose from: nautical mile/knots (nm/kt), kilometer/kilometers per hour(km/kmh), yard/knot(yd/kt).

cf) 1nm = 1.852km, 1kt /h= 1.852km/h, less than 1nm display in yard and over 1nm display in mile

(☞The default setting is Nm/Kt.)

2.1.2. Depth

Select desired unit of measure for depth of water. Choose from: meter(M), foot(ft), fathom(fm), Italian Fathom(lfm), Japanese fathom(Jfm).

cf) 1m = 3.281ft = 0.549fm = 0.609lfm = 0.660jfm

(☞The default setting is Meter.)

2.1.3. TEMP

Select desired unit of measure for temperature of water. Choose from: Celsius(°C), or Fahrenheit(°F).

cf) 1°C = +32°F

2.2. Compass

2.2.1. BRG

There is a difference degree where you are in the earth. This function is to modify the error from true and Magnetic.

(☞The default setting is Auto.)

2.2.2. Variation

There could be a difference between the magnetic compass and the GPS compass. An error depends upon your area.

2.3. Time & Date

2.3.1. Reference

Available to adjust the collect local time by the UTC time from the GPS.

(☞ The default setting is incorrect every the country.)

2.3.2. Time Format

Sets you preferred time between 12 hour or 24 hour.

(☞ The default setting is 12 hour.)

2.3.3. Date Format

Sets you preferred date among YY-MM-DD, MM-DD-YY or DD-MM-YY.

(☞ The default setting is YY-MM-DD.)

2.3.4. Month format

Sets you preferred date between Character or Number.

2.3.5. Calendar setup

2.3.5.1. Week starts on

You can select the first day of week.

(☞ The default setting is SUN.)

2.3.5.2. Color Saturday

You can setup the color of Saturday.

2.3.5.3. Color Sunday

You can setup the color of Sunday.

2.4 Input/Output

2.4.1. Output Sentences

The chartplotter allows customizing the NMEA-0183 sentence.

DESCRIPTIONS	CONTENTS OF DATA FIELD	DEFAULT
\$GPGGA	Global Positioning System Fix Data	ON
\$GPVTG	Course and Ground Speed	ON
\$GPZDA	Time and Date	OFF
\$GPRMB	Recommended minimum navigation information	OFF
\$GPRMC	Recommended Minimum Specific GPS/TRANSIT DATA	OFF
\$GPAPB	Heading/track controller (Autopilot) sentence B	ON
\$GPXTE	Cross-track error, measured	OFF
\$GPBOD	Bearing, origin to destination	OFF
\$GPBWC	Bearing and distance to waypoint	ON
\$SYPLT	Samyoung autopilot	OFF

2.4.2. Transmit

Available to adjust transmit speed of input/output in each ports.

2.4.3. Buzzer

It is can be buzzer on/off.

(☞ The default setting is on.)

2.4.4. Backlight time out

It is the screen sets the time to sleep mode.

(☞ The default setting is off.)

2.4.5. Customizing

2.4.5.1. Databar

2.4.5.1.1. Display

Setting up shown/hide the databar on the display.

(☞ The default setting is Shown.)

2.4.5.1.2. Position

Setting up up/down the position of databar on the display.

(☞ The default setting is Down.)

2.4.5.1.3. Edit

It customizes the data bar information.

2.4.5.1.4 Mode

It is available to set up the data bar.

- Customizing : It is selectable and modifiable the data bar by user.
- Fix mode : It is fixed data bar by default. It is not available selectable and modifiable the data bar by user.

(☞ The default is User mode.)

2.4.5.2. Navigation Data

2.4.5.2.1. Type

It is a select the navigation data type.

(☞ The default setting is Type1.)

2.4.5.2.2. Edit

It customizes the Navigation data section except activated the fishfinder section.

2.4.5.3. Sidebar

2.4.5.3.1. Display

Shown/Hidden "Sidebar"..

(☞ The default setting is off.)

2.4.5.3.2. Position

Choosing the position of "Sidebar" on the right and left.

(☞ The default setting is left.)

2.4.5.3.3. Edit

Editing "Sidebar".

2.4.5.4. Menu

2.4.5.4.1. Type

Two kinds of Menu, "HGP" and "Smart".

(☞ The default setting is smart.)

2.4.5.4.2. Color

Changing the menu color.

(☞ The default setting is orange.)

2.4.5.5. INFO Window

2.4.5.5.1 WPT

While navigating, shown/hidden "WPT information".

(☞ The default setting is shown.)

2.4.5.5.2 Cursor

When the cursor is on the screen, shown/hidden the cursor window.

(☞ The default setting is shown.)

2.4.5.5.3 Position Setup

Choose the position of Information window.

( The default setting is Auto.)

2.4.5.6. Userdata

2.4.5.6.1. WPT

16 kinds of symbol and color. Choose the symbols and the colors.

2.4.5.6.1.1. Symbol Setup

In 16 kinds of the symbols, you can choose as many as you want, and those will show on the WPT symbol window.

2.4.5.6.1.2. Color Setup

In 16 kinds of the colors, you can choose as many as you want, and those will show on the WPT color window.

2.4.5.6.2. Track

2.4.5.6.2.1. Color Setup

In 16 kinds of the colors, you can choose as many as you want, and those will show on the track color window.

2.4.5.6. Page mode

It is a select the page mode.

- Standard: Choosing Page and customizing is available.

- Flip: Showing the chosen pages in order.

( The default setting is Standard.)

2.4.6. TD Setup

It sets Chain, Pair, ASF

3. Maintenance

It is necessary to check the system or the version for maintenance and demonstrate Smart4/5 series with the simulators

3.1. Program Version

It contains ID and the program version, and it has important information for maintenance and upgrade.

3.2. OS Version

It contains the version of OS, which is necessary for maintenance and upgrade

3.3. MAP Version

It contains the version of the chart, the datum and the number, which is necessary for maintenance and upgrade

3.4. Simulator

It is necessary for an indoor demonstration. The simulations of GPS, Fish finder or AIS in the memory..

3.5. Language

Select the language.

3.6. Initialization

3.6.1. User Initialization

The stored setting is initialized in the user setting.

3.6.1. Setup Initialization

reset without deleting user data.

3.6.2. Factory Initialization

returning to the initial system from the releasing of factory.

(*All user data will be deleted)

4. Others

4.1. Screen capture

This is the function of save the current screen

Note: The capture file is stored in external SD card.

(*The storage location is “..\HY\Capture\” in SD card).

4.2. Capture List

Available to display and delete the capture file

4.3. Save User Setting

Storing the user initialization for the default. The current is storing.

SVS-560C

General specification

- | | |
|---------------------------|------------------------------------|
| 1. Display Screen: | 5inch Color LCD with LED backlight |
| 2. Resolution: | WVAG (800 X 480 pixels) |
| 3. Power Supply: | DC 12V~36V(+/-10%) 5W |
| 4. Operating Temperature: | -15°C~+50°C |
| 5. Performance Standard: | IMO Resolution MSC.112(73) |
| 6. Option: | MicroSD, External GPS Antenna |

GPS Receiver specification

- | | |
|------------------------------------|--------------------------------------|
| 1. GNSS Receiver Capabilities | |
| GPS | L1 C/A code |
| GLONASS | L1OF/ |
| QZSS | L1 C/A code |
| Galileo | E1B/E1C/L1 |
| 2. Number of Channel: | 52 channels |
| 3. Horizontal Positioning Accuracy | |
| Autonomous 2.5m (CEP 50%) | |
| 4. Sensitivity | |
| Acquisition | -148 dBm |
| Tracking | -165 dBm |
| Reacquisition | -162 dBm |
| 5. Nav Update: | 1Hz, 5Hz |
| 6. Support: | DGPS, SBAS(EGNOS, WAAS, MASA, GAGAN) |

Chartplotter specification

- | | |
|---------------------|-----------------------------------------------------------------------------------------------------------------------|
| 1. Display Method: | Mercator Projection |
| 2. Display Mode: | True motion / N/S/E/W up / Course up / Head up |
| 3. Latitude Limits: | Between 85°N to 85°S |
| 4. Map Scale: | 0.05nm to 1500nm |
| 5. Map Datum: | WGS-84 |
| 6. Waypoint: | 20,000 points
*Total of 16 colors and 16 icons are selectable each point with name tag (8 alphanumeric characters) |
| 7. Track Point: | 50,000 points(2 types) |
| 8. Route: | Max capacity 100 Routes
*20 WPTs per each Route. Each with name tags (8 alphanumeric characters) |
| 9. Draw Point: | 1,000 points |
| 10. Area Name: | 1,000 points |
| 11. Chart Data: | HY-MAP(Built-in or External)/ C-MAP |
| 12. Output Data: | NMEA-0183 |
| 13. Input Data: | NMEA-0183 |
| 14. Alarm: | Arrival, Anchor, XTE, Interval timer, User line |

Standard Equipment Configuration List

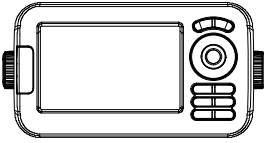

Display unit

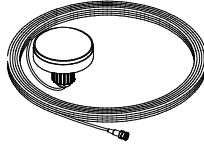

External GPS ANT(option)



Manual

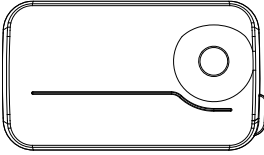

Protector

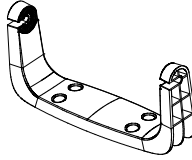

Mounting Bracket

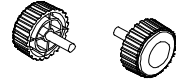

Knobs



Fuse & Bolt

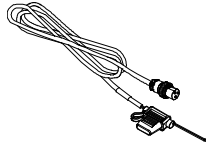

Power cable

Dimension

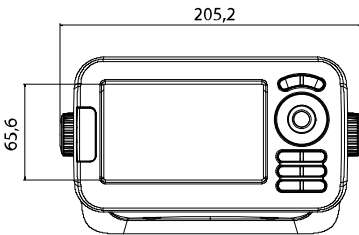

<FRONT>

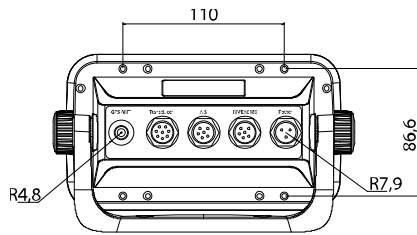

<BACK>

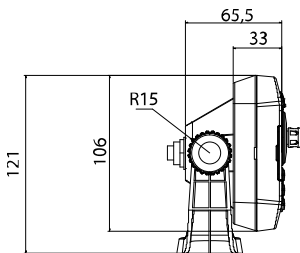

<LEFT>

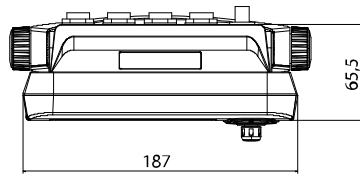

<TOP>

SVS-560CF

General specification

- | | |
|---------------------------|-------------------------------------------|
| 1. Display Screen: | 5inch Color LCD with LED backlight |
| 2. Resolution: | WVAG (800 X 480 pixels) |
| 3. Power Supply: | DC 12V~36V(+/-10%) 7W |
| 4. Operating Temperature: | -15°C~+50°C |
| 5. Performance Standard: | IMO Resolution MSC.112(73) |
| 6. Option: | MicroSD, External GPS Antenna, Transducer |

GPS Receiving specification

- | | |
|------------------------------------|--------------------------------------|
| 1. GNSS Receiver Capabilities | |
| GPS | L1 C/A code |
| GLONASS | L1OF/ |
| QZSS | L1 C/A code |
| Galileo | E1B/E1C/L1 |
| 2. Number of Channel: | 52 channels |
| 3. Horizontal Positioning Accuracy | |
| Autonomous 2.5m (CEP 50%) | |
| 4. Sensitivity | |
| Acquisition | -148 dBm |
| Tracking | -165 dBm |
| Reacquisition- | 162 dBm |
| 5. Nav Update: | 1Hz, 5Hz |
| 6. Support: | DGPS, SBAS(EGNOS, WAAS, MASA, GAGAN) |

Chartplotter specification

- | | |
|---------------------|-----------------------------------------------------------------------------------------------------------------------|
| 1. Display Method: | Mercator Projection |
| 2. Display Mode: | True motion / N/S/E/W up / Course up / Head up |
| 3. Latitude Limits: | Between 85°N to 85°S |
| 4. Map Scale: | 0.05nm to 1500nm |
| 5. Map Datum: | WGS-84 |
| 6. Waypoint: | 20,000 points
*Total of 16 colors and 16 icons are selectable each point with name tag (8 alphanumeric characters) |
| 7. Track Point: | 50,000 points(2 types) |
| 8. Route: | Max capacity 100 Routes
*20 WPTs per each Route. Each with name tags (8 alphanumeric characters) |
| 9. Draw Point: | 1,000 points |
| 10. Area Name: | 1,000 points |
| 11. Chart Data: | HY-MAP(Built-in or External)/ C-MAP |
| 12. Output Data: | NMEA-0183 |
| 13. Input Data: | NMEA-0183 |
| 14. Alarm: | Arrival, Anchor, XTE, Interval timer, User line |

Fishfinder specification

- | | |
|------------------|-------------------------------------------------------------------|
| 1. Display Mode: | Normal (single/dual-frequency), Bottom-lock, Bottom-zoom, A-scope |
| 2. Frequency: | 50 and 200 KHz (single or dual) |

- 3. Output Power: 300W/ 600W
- 4. Range speed: 300W : 2.5m ~ 300m / 600W : 2.5m ~ 600m
- 5. Image speed: Fixed 8 speeds (4/1, 2/1, 1/1, 1/2, 1/4, 1/8, 1/16, 1/32) and stop
- 6. Rejection: Interferences rejection:3 levels, Noise rejection:4 levels
- 7. Function: Gain(auto/manual), Range(auto/manual),
Depth with shift(auto/manual)
Pulse length selection, White/Black line
Water temperature, Support speed sensor

Standard Equipment Configuration List

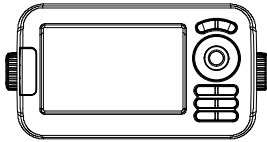

Display unit

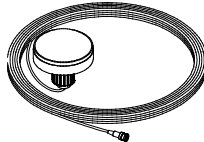

External GPS ANT(option)

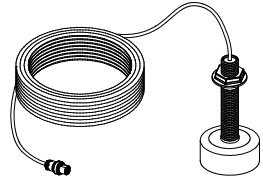

Transducer(option)

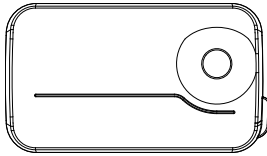

Protector

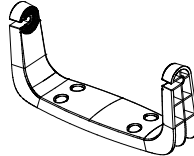

Mounting Bracket

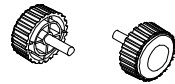

Knobs



Fuse & Bolt

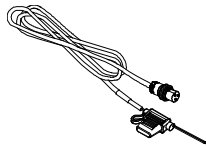

Power cable

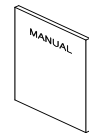

Manual

Dimension

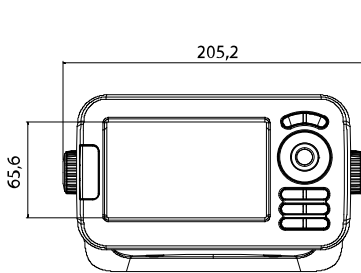

<FRONT>

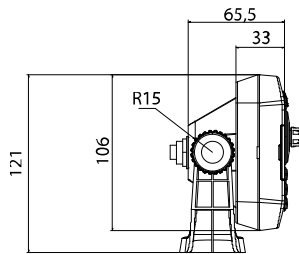

<LEFT>

SVS-460C

General specification

- | | |
|---------------------------|--------------------------------------|
| 1. Display Screen: | 4.3inch Color LCD with LED backlight |
| 2. Resolution: | WVAG (480 X 272 pixels) |
| 3. Power Supply: | DC 12V~36V(+/-10%) 4W |
| 4. Operating Temperature: | -15°C~+50°C |
| 5. Performance Standard: | IMO Resolution MSC.112(73) |
| 6. Option: | MicroSD, External GPS Antenna |

GPS Receiver specification

- | | |
|------------------------------------|--------------------------------------|
| 1. GNSS Receiver Capabilities | |
| GPS | L1 C/A code |
| GLONASS | L1OF/ |
| QZSS | L1 C/A code |
| Galileo | E1B/E1C/L1 |
| 2. Number of Channel: | 52 channels |
| 3. Horizontal Positioning Accuracy | |
| Autonomous 2.5m (CEP 50%) | |
| 4. Sensitivity | |
| Acquisition | -148 dBm |
| Tracking | -165 dBm |
| Reacquisition- | 162 dBm |
| 5. Nav Update: | 1Hz, 5Hz |
| 6. Support: | DGPS, SBAS(EGNOS, WAAS, MASA, GAGAN) |

Chartplotter specification

- | | |
|---------------------|-----------------------------------------------------------------------------------------------------------------------|
| 1. Display Method: | Mercator Projection |
| 2. Display Mode: | True motion / N/S/E/W up / Course up / Head up |
| 3. Latitude Limits: | Between 85°N to 85°S |
| 4. Map Scale: | 0.05nm to 1500nm |
| 5. Map Datum: | WGS-84 |
| 6. Waypoint: | 20,000 points
*Total of 16 colors and 16 icons are selectable each point with name tag (8 alphanumeric characters) |
| 7. Track Point: | 50,000 points(2 types) |
| 8. Route: | Max capacity 100 Routes
*20 WPTs per each Route. Each with name tags (8 alphanumeric characters) |
| 9. Draw Point: | 1,000 points |
| 10. Area Name: | 1,000 points |
| 11. Chart Data: | HY-MAP(Built-in or External)/ C-MAP |
| 12. Output Data: | NMEA-0183 |
| 13. Input Data: | NMEA-0183 |
| 14. Alarm: | Arrival, Anchor, XTE, Interval timer, User line |

Standard equipment configuration List

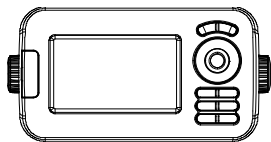

Display unit

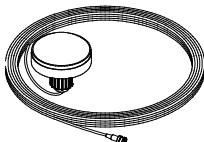

External GPS ANT(option)



Manual

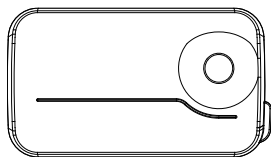

Protector

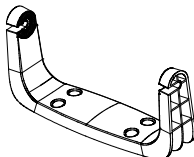

Mounting Bracket

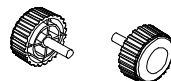

Knobs



Fuse & Bolt

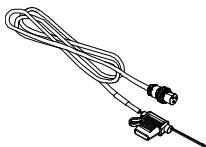

Power cable

Dimension

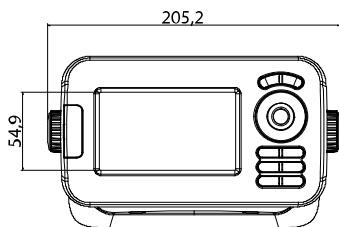

<FRONT>

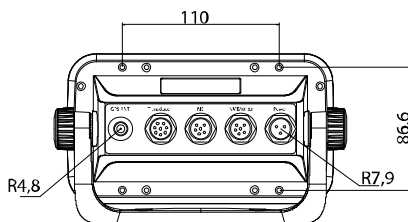

<BACK>

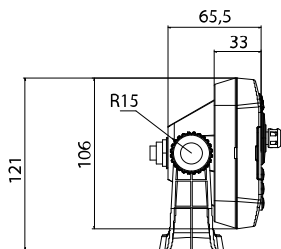

<LEFT>

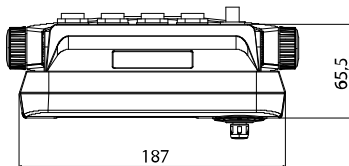

<TOP>

SVS-460CF

General specification

- | | |
|---------------------------|-------------------------------------------|
| 1. Display Screen: | 4.3inch Color LCD with LED backlight |
| 2. Resolution: | WVAG (480 X 272 pixels) |
| 3. Power Supply: | DC 12V~36V(+/-10%) 6W |
| 4. Operating Temperature: | -15°C~+50°C |
| 5. Performance Standard: | IMO Resolution MSC.112(73) |
| 6. Option: | MicroSD, External GPS Antenna, Transducer |

GPS Receiver specification

- | | |
|------------------------------------|--------------------------------------|
| 1. GNSS Receiver Capabilities | |
| GPS | L1 C/A code |
| GLONASS | L1OF/ |
| QZSS | L1 C/A code |
| Galileo | E1B/E1C/L1 |
| 2. Number of Channel: | 52 channels |
| 3. Horizontal Positioning Accuracy | |
| Autonomous 2.5m (CEP 50%) | |
| 4. Sensitivity | |
| Acquisition | -148 dBm |
| Tracking | -165 dBm |
| Reacquisition | -162 dBm |
| 5. Nav Update: | 1Hz, 5Hz |
| 6. Support: | DGPS, SBAS(EGNOS, WAAS, MASA, GAGAN) |

Chartplotter specification

- | | |
|---------------------|-----------------------------------------------------------------------------------------------------------------------|
| 1. Display Method: | Mercator Projection |
| 2. Display Mode: | True motion / N/S/E/W up / Course up / Head up |
| 3. Latitude Limits: | Between 85°N to 85°S |
| 4. Map Scale: | 0.05nm to 1500nm |
| 5. Map Datum: | WGS-84 |
| 6. Waypoint: | 20,000 points
*Total of 16 colors and 16 icons are selectable each point with name tag (8 alphanumeric characters) |
| 7. Track Point: | 50,000 points(2 types) |
| 8. Route: | Max capacity 100 Routes
*20 WPTs per each Route. Each with name tags (8 alphanumeric characters) |
| 9. Draw Point: | 1,000 points |
| 10. Area Name: | 1,000 points |
| 11. Chart Data: | HY-MAP(Built-in or External)/ C-MAP |
| 12. Output Data: | NMEA-0183 |
| 13. Input Data: | NMEA-0183 |
| 14. Alarm: | Arrival, Anchor, XTE, Interval timer, User line |
| 14. Alarm: | Arrival, Anchor, XTE, Interval timer, User line |

Fifhfinder specification

- | | |
|------------------|-------------------------------------------------------------------|
| 1. Display Mode: | Normal (single/dual-frequency), Bottom-lock, Bottom-zoom, A-scope |
|------------------|-------------------------------------------------------------------|

- 2. Frequency: 50 and 200 KHz (single or dual)
- 3. Output Power: 300W/ 600W
- 4. Range speed: 300W : 2.5m ~ 300m / 600W : 2.5m ~ 600m
- 5. Image speed: Fixed 8 speeds (4/1, 2/1, 1/1, 1/2, 1/4, 1/8, 1/16, 1/32) and stop
- 6. Rejection: Interferences rejection:3 levels, Noise rejection:4 levels
- 7. Function: Gain(auto/manual), Range(auto/manual), Depth with shift(auto/manual), Pulse length selection, White/Black line
Water temperature, Support speed sensor

Standard Equipment Configuration List

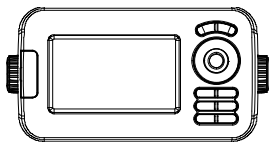

Display unit

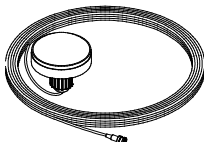

External GPS ANT(option)

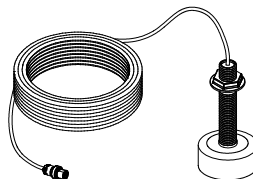

Transducer(option)

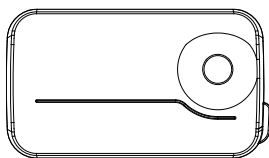

Protector

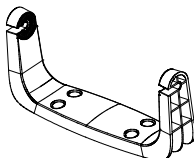

Mounting Bracket

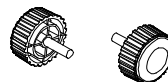

Knobs



Fuse & Bolt

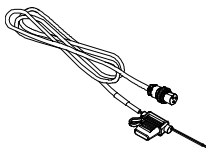

Power cable



Manual

Dimension

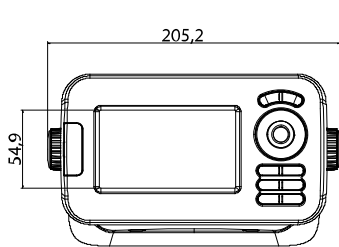

<FRONT>

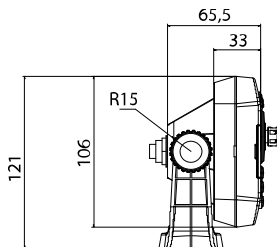

<LEFT>

Customizing items

POG	LAT/LOT of the present position. (Red: out of GPS service/Black: GPS on service/Blue: SBAS or DGPS on service)
SOG	(Speed Of Ground) Boat speed.
COG	(Course Of Ground) Boat direction.
DATE	Date of today.
TIME	Present time.
HDOP	Horizontal Dilution Of Precision.
PDOP	Position Dilution Of Precision.
W.POG	WPT Position Of Ground
W.NAME	(WPT Name) the present WPT of the destination
#DEPTH	Present depth.
#TEMP	(Temperature) Present water temperature.
TOT TIME	(Total Time) Total using time
VOLTAGE	Present voltage. (unstable voltage shows in red)
TTG	(Time To Goal) Remaining time to the destination.
ETA	Estimated time of arrival.
XTE	Cross track error.
W.RNG	Distance from the present position to the WPT.
W.BRG	Bearing between the present position and the WPT.
W.INFO	The total number of WPT and shows the WPT symbol/color.
TRACK	The total number of track and shows the track color.
DATE&TIME	The current date and time.
C.POG	LAT/LOT of the cursor.
C.BRG	Bearing between the present position and the cursor.
C.RNG	Distance between the present position and the cursor.

1
2
3
4
5
6
7
8

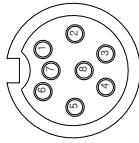
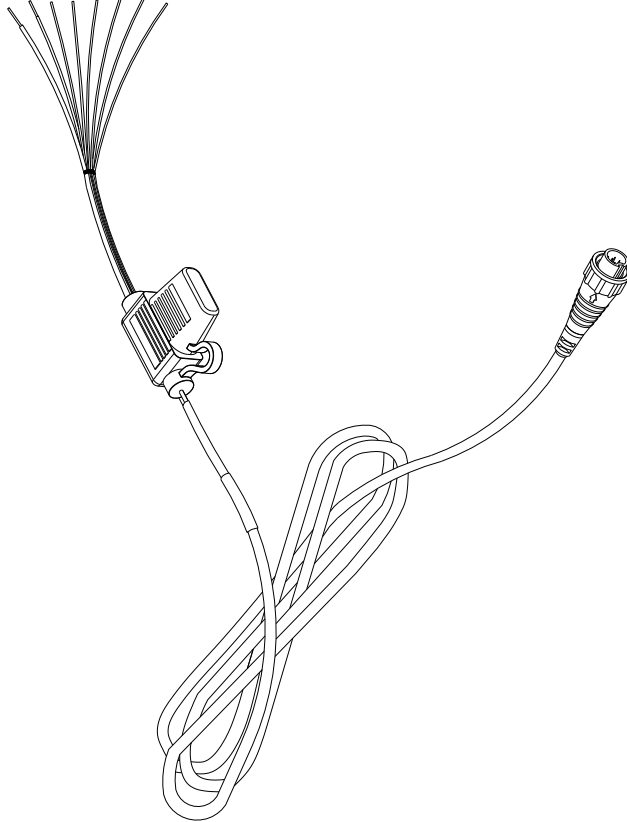

Power Cable		
PIN #	WIRE COLOR	FUNCTION
1	BLACK	GND/COMMON
2	RED	DC 13V -36V
3	WHITE	INPUT 1
4	GREEN	NC
5	GRAY	OUTPUT 2 (AIS)
6	YELLOW	OUTPUT 1
7	BROWN	INPUT 2 (AIS)
8	BLUE	GND

MATERIAL		DESCRIPTION	
SCALE 1/2	MODEL SVS-560/460 series	Power Cable	
PERN Kim Y.S.	CHK. BY Kim Y.S.	DWG. NO. S5-DC10301P	
	DES. BY Kim Y.S.	DATE 2014.04.07	
			SI-TEX MARINE ELECTRONICS

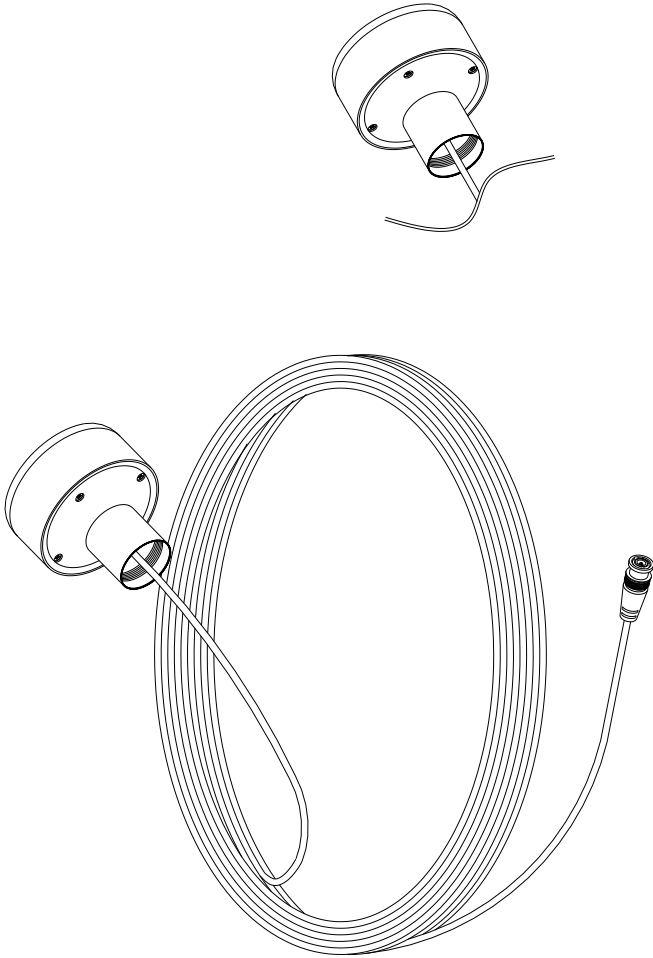

 MATERIAL S/S-560/460 series		DESCRIPTION External GPS Antenna	
SCALE 1/1		DWG. NO. S5-FA90101	
PERN KIM Y.S	DES. BY KIM Y.S	DRA. BY KIM Y.S	DATE 03.26.2014
SI-TEX MARINE ELECTRONICS			

CERTIFICATE OF LIMITED WARRANTY

Providing you present a valid proof of purchase, SI-TEX Marine Electronics Inc. warrants all parts of each new product against defects in material and workmanship under normal use and will repair or exchange any parts proven to be defective at no charge for a period of two years for parts and one year for labor from the date of purchase, except as provided below under Limited Warranty Exceptions. Defects will be corrected during normal working hours by an authorized SI-TEX Marine Electronics Inc. dealer, service center, or at the SI-TEX office in Riverhead, NY. There will be no charge for labor for a period of one year from the date of purchase, except as provided below under Limited Warranty Exceptions.

This Warranty and Proof of Purchase must be made available to the authorized SI-TEX Marine Electronics Inc. service location or dealer at the time of service.

LIMITED WARRANTY EXCEPTIONS

SI-TEX Marine Electronics Inc. will not be responsible for equipment which has been subjected to water or lightning damage, accident, abuse, or misuse, nor any equipment on which the serial number label has been removed, altered or mutilated.

SI-TEX Marine Electronics Inc. assumes no responsibility for damage incurred during installation.

This Limited Warranty is effective only with respect to the original purchaser.

Any cost associated with transducer replacement, other than the cost of the transducer itself, is specifically excluded from this Limited Warranty.

Travel costs incurred will not be accepted for SI-TEX Marine Electronics Inc. products.

THERE ARE NO WARRANTIES, WHICH EXTEND BEYOND THE DESCRIPTION OF THE FACE HEREOF.

SPECIFIC EXCLUSIONS

Charges for overtime, stand-by, holiday, and per diem are specifically excluded from the Limited Warranty. Installation workmanship or materials except as provided directly by SI-TEX Marine Electronics Inc. are not covered by this Limited Warranty. SI-TEX Marine Electronics Inc. equipment or parts thereof, which have been repaired or altered except by an authorized SI-TEX Marine Electronics Inc. dealer or service center, are not warranted in any respect. Transducer, software update, battery, microphone, magnetron, and microwave components and water damage on water resistant VHF radio are items excluded from the two-year warranty and are covered by warranty for a period of one year for both parts and labor. SI-TEX Marine Electronics Inc. will not, at any time, assume any costs or labor charges for checkout or external line fuse replacement or problems not found to be at fault in equipment itself.

THERE ARE NO WARRANTIES OR GUARANTEES EXPRESSED OR IMPLIED WHICH EXTEND BEYOND THE DESCRIPTION ON THE FACE HEREOF, INCLUDING WARRANTIES OF FITNESS FOR A PARTICULAR PURPOSE AND MERCHANTABILITY. SI-TEX MARINE ELECTRONICS INC. HAS NO OTHER LIABILITY TO PURCHASE FOR DIRECT OR CONSEQUENTIAL DAMAGE OR ANY THEORY INCLUDING ABSOLUTE LIABILITY, TORT, OR CONTRACT. THIS LIMITED WARRANTY CANNOT BE ALTERED OR MODIFIED IN ANY WAY AND SHALL BE INTERPRETED IN ACCORDANCE WITH THE LAWS OF THE STATE OF NEW YORK. THIS WARRANTY IS LIMITED TO THE CONTINENTAL U.S.A., ALASKA, HAWAII, AND CANADA.

HOW TO OBTAIN SERVICE UNDER THIS WARRANTY

If you encounter problems during the installation or operation of this product, or cannot find the information you need, please contact SI-TEX Customer Service.

The contact numbers and e-mail address for SI-TEX Customer Service are:

SI-TEX Main Office.....+1-631-996-2690

SI-TEX Fax.....+1-631-996-2693

SI-TEX Service E-mail address: service@si-tex.com

SI-TEX Customer Support E-mail address: custsvc@si-tex.com

SI-TEX Main Office Address:

25 Enterprise Zone Drive, Ste 2

Riverhead, NY 11901

Technical Support is available from 9:00 AM to 5:00 PM Eastern Standard Time, Monday through Friday.