

i50 Depth i50 Speed i50 Tridata

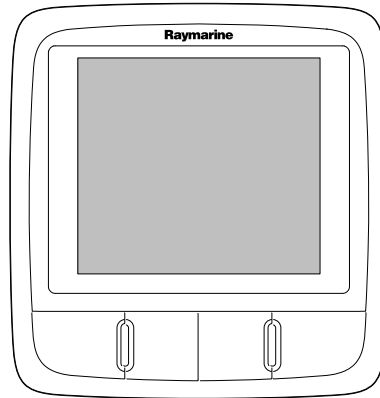

Installation and operation instructions

English

Date: 06-2014

Document number: 81341-2-EN

© 2014 Raymarine UK Limited

Trademark and patents notice

Autohelm, hsb², RayTech Navigator, Sail Pilot, SeaTalk, SeaTalk^{NG}, SeaTalk^{HS} and Sportpilot are registered trademarks of Raymarine UK Limited. RayTalk, Seahawk, Smartpilot, Pathfinder and Raymarine are registered trademarks of Raymarine Holdings Limited.

FLIR is a registered trademark of FLIR Systems, Inc. and/or its subsidiaries.

All other trademarks, trade names, or company names referenced herein are used for identification only and are the property of their respective owners.

This product is protected by patents, design patents, patents pending, or design patents pending.

Fair Use Statement

You may print no more than three copies of this manual for your own use. You may not make any further copies or distribute or use the manual in any other way including without limitation exploiting the manual commercially or giving or selling copies to third parties.

Software updates

Check the website www.raymarine.com for the latest software releases for your product.

Product handbooks

The latest versions of all English and translated handbooks are available to download in PDF format from the website www.raymarine.com.

Please check the website to ensure you have the latest handbooks.

Copyright ©2014 Raymarine UK Ltd. All rights reserved.

Contents

Chapter 1 Important information.....	7	6.12 Illumination	41
Certified Installation	7	Chapter 7 i50 Speed	43
Water ingress	7	7.1 i50 Speed operation	44
Disclaimer	7	7.2 i50 Speed controls	44
EMC installation guidelines	7	7.3 Power	45
Suppression ferrites	8	7.4 Data master	45
Connections to other equipment	8	7.5 Calibration	46
Declaration of conformity.....	8	7.6 User Calibration - i50 Speed	46
Product disposal.....	8	7.7 Intermediate calibration — i50 Speed	49
Warranty registration.....	8	7.8 Dealer calibration — i50 Speed	51
IMO and SOLAS.....	8	7.9 Using the speed pages.....	52
Technical accuracy	9	7.10 Using the log, trip and temperature pages.....	53
Chapter 2 Handbook information.....	11	7.11 Using the timers	53
2.1 Document information	12	7.12 Illumination	54
2.2 Parts supplied	13	Chapter 8 i50 Tridata	55
2.3 i50 Product overview	14	8.1 i50 Tridata operation	56
Chapter 3 Planning the installation	15	8.2 i50 Tridata controls.....	56
3.1 Installation checklist	16	8.3 Power	57
3.2 Compatible transducers.....	16	8.4 Data master.....	57
3.3 Typical systems	18	8.5 Calibration	58
3.4 System protocols	20	8.6 User Calibration - i50 Tridata	58
3.5 Tools required	20	8.7 Intermediate calibration — i50 Tridata	62
3.6 Selecting a display location.....	21	8.8 Dealer calibration — i50 Tridata	63
3.7 Product dimensions.....	22	8.9 Using Tridata depth pages.....	65
3.8 Selecting a transducer location	22	8.10 Using Tridata speed pages.	65
Chapter 4 Cables and connections.....	23	8.11 Using Tridata trip, log, temp and timer pages	66
4.1 General cabling guidance	24	8.12 Using the timers	66
4.2 Power connection	24	8.13 Alarms.....	67
4.3 SeaTalk ^{ng} connections	25	8.14 Illumination	68
4.4 Transducer connections	26	Chapter 9 Maintaining your display.....	69
4.5 iTC-5 connection.....	27	9.1 Service and maintenance	70
4.6 SeaTalk connection	27	9.2 Condensation	70
4.7 NMEA2000 connection.....	28	9.3 Routine equipment checks.....	71
Chapter 5 Mounting.....	29	9.4 Cleaning.....	71
5.1 Mounting	30	9.5 Cleaning the display case.....	72
5.2 Front bezel	31	9.6 Cleaning the display screen	72
Chapter 6 i50 Depth.....	33	Chapter 10 Troubleshooting.....	73
6.1 i50 Depth operation	34	10.1 Troubleshooting	74
6.2 i50 Depth controls	34	10.2 Instrument troubleshooting.....	75
6.3 Power	35	10.3 Power up troubleshooting	76
6.4 Data master.....	35	10.4 Miscellaneous troubleshooting	77
6.5 Calibration.....	36	Chapter 11 Technical support	79
6.6 User Calibration - i50 Depth.....	36	11.1 Raymarine customer support.....	80
6.7 Intermediate calibration — i50 Depth.....	37	11.2 Checking the software version.....	80
6.8 Dealer calibration — i50 Depth.....	38	Chapter 12 Technical specification.....	81
6.9 Using the depth pages.....	39	12.1 Technical specification	82
6.10 Viewing the depth offset.....	39	Chapter 13 Spares and accessories	83
6.11 Alarms.....	40		

13.1 Spares.....	84
13.2 SeaTalk ^{ng} cables and accessories	84
13.3 Converters.....	85
Appendix A NMEA 2000 sentences	87

Chapter 1: Important information

Certified Installation

Raymarine recommends certified installation by a Raymarine approved installer. A certified installation qualifies for enhanced product warranty benefits. Contact your Raymarine dealer for further details, and refer to the separate warranty document packed with your product.



Warning: Product installation and operation

This product must be installed and operated in accordance with the instructions provided. Failure to do so could result in personal injury, damage to your vessel and/or poor product performance.



Warning: Potential ignition source

This product is NOT approved for use in hazardous/flammable atmospheres. Do NOT install in a hazardous/flammable atmosphere (such as in an engine room or near fuel tanks).



Warning: Positive ground systems

Do not connect this unit to a system which has positive grounding.

Caution: Power supply protection

When installing this product ensure the power source is adequately protected by means of a suitably-rated fuse or automatic circuit breaker.



Warning: Switch off power supply

Ensure the vessel's power supply is switched OFF before starting to install this product. Do NOT connect or disconnect equipment with the power switched on, unless instructed in this document.



Warning: High voltage

This product contains high voltage. Adjustments require specialized service procedures and tools only available to qualified service technicians. There are no user serviceable parts or adjustments. The operator should never remove the cover or attempt to service the product.

Caution: Transducer cable

- Do NOT cut, shorten, or splice the transducer cable.
- Do NOT remove the connector.

If the cable is cut, it cannot be repaired. Cutting the cable will also void the warranty.

Caution: Service and maintenance

This product contains no user serviceable components. Please refer all maintenance and repair to authorized Raymarine dealers. Unauthorized repair may affect your warranty.

Water ingress

Water ingress disclaimer

Although the waterproof rating capacity of this product meets the stated IPX standard (refer to the product's *Technical Specification*), water intrusion and subsequent equipment failure may occur if the product is subjected to commercial high-pressure washing. Raymarine will not warrant products subjected to high-pressure washing.

Disclaimer

Raymarine does not warrant that this product is error-free or that it is compatible with products manufactured by any person or entity other than Raymarine.

Raymarine is not responsible for damages or injuries caused by your use or inability to use the product, by the interaction of the product with products manufactured by others, or by errors in information utilized by the product supplied by third parties.

EMC installation guidelines

Raymarine equipment and accessories conform to the appropriate Electromagnetic Compatibility (EMC) regulations, to minimize electromagnetic interference between equipment and minimize the effect such interference could have on the performance of your system

Correct installation is required to ensure that EMC performance is not compromised.

Note: In areas of extreme EMC interference, some slight interference may be noticed on the product. Where this occurs the product and the source of the interference should be separated by a greater distance.

For **optimum** EMC performance we recommend that wherever possible:

- Raymarine equipment and cables connected to it are:

- At least 1 m (3 ft) from any equipment transmitting or cables carrying radio signals e.g. VHF radios, cables and antennas. In the case of SSB radios, the distance should be increased to 7 ft (2 m).
- More than 2 m (7 ft) from the path of a radar beam. A radar beam can normally be assumed to spread 20 degrees above and below the radiating element.
- The product is supplied from a separate battery from that used for engine start. This is important to prevent erratic behavior and data loss which can occur if the engine start does not have a separate battery.
- Raymarine specified cables are used.
- Cables are not cut or extended, unless doing so is detailed in the installation manual.

Note: Where constraints on the installation prevent any of the above recommendations, always ensure the maximum possible separation between different items of electrical equipment, to provide the best conditions for EMC performance throughout the installation

Suppression ferrites

Raymarine cables may be fitted with suppression ferrites. These are important for correct EMC performance. If a ferrite has to be removed for any purpose (e.g. installation or maintenance), it must be replaced in the original position before the product is used.

Use only ferrites of the correct type, supplied by Raymarine authorized dealers.

Where an installation requires multiple ferrites to be added to a cable, additional cable clips should be used to prevent stress on the connectors due to the extra weight of the cable.

Connections to other equipment

Requirement for ferrites on non-Raymarine cables

If your Raymarine equipment is to be connected to other equipment using a cable not supplied by Raymarine, a suppression ferrite **MUST** always be attached to the cable near the Raymarine unit.

Caution: Sun covers

- To protect your product against the damaging effects of ultraviolet (UV) light, always fit the sun covers when the product is not in use.
- Remove the sun covers when travelling at high speed, whether in water or when the vessel is being towed.

Caution: Cleaning

When cleaning this product:

- Do NOT wipe the display screen with a dry cloth, as this could scratch the screen coating.
- Do NOT use abrasive, or acid or ammonia based products.
- Do NOT use a jet wash.

Caution: Condensation

Certain atmospheric conditions may cause a small amount of condensation to form on the unit's window. This will not damage the unit and will clear after the unit has been switched on for a short period.

Declaration of conformity

Raymarine UK Ltd. declares that this product is compliant with the essential requirements of EMC directive 2004/108/EC.

The original Declaration of Conformity certificate may be viewed on the relevant product page at www.raymarine.com.

Product disposal

Dispose of this product in accordance with the WEEE Directive.



The Waste Electrical and Electronic Equipment (WEEE) Directive requires the recycling of waste electrical and electronic equipment. Whilst the WEEE Directive does not apply to some Raymarine products, we support its policy and ask you to be aware of how to dispose of this product.

Warranty registration

To register your Raymarine product ownership, please visit www.raymarine.com and register online.

It is important that you register your product to receive full warranty benefits. Your unit package includes a bar code label indicating the serial number of the unit. You will need this serial number when registering your product online. You should retain the label for future reference.

IMO and SOLAS

The equipment described within this document is intended for use on leisure marine boats and workboats NOT covered by International Maritime Organization (IMO) and Safety of Life at Sea (SOLAS) Carriage Regulations.

Technical accuracy

To the best of our knowledge, the information in this document was correct at the time it was produced. However, Raymarine cannot accept liability for any inaccuracies or omissions it may contain. In addition, our policy of continuous product improvement may change specifications without notice. As a result, Raymarine cannot accept liability for any differences between the product and this document. Please check the Raymarine website (www.raymarine.com) to ensure you have the most up-to-date version(s) of the documentation for your product.

Chapter 2: Handbook information

Chapter contents

- [2.1 Document information on page 12](#)
- [2.2 Parts supplied on page 13](#)
- [2.3 i50 Product overview on page 14](#)

2.1 Document information

This document contains important information related to the installation of your Raymarine product.





The document includes information to help you:

- plan your installation and ensure you have all the necessary equipment;
- install and connect your product as part of a wider system of connected marine electronics;
- troubleshoot problems and obtain technical support if required.

This and other Raymarine product documents are available to download in PDF format from www.raymarine.com.

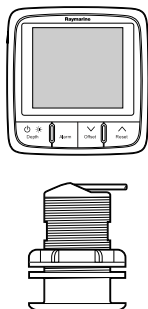
Applicable products

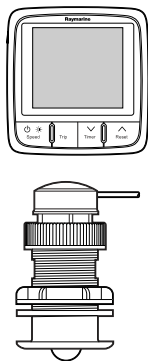
This document is applicable to the following products:

Item	Model	Part number	Hardware
	i50 Depth	E70059	i50 Depth SeaTalk ^{ng} instrument display
	i50 Depth Thru-hull system pack	E70148	<ul style="list-style-type: none"> • i50 Depth SeaTalk^{ng} instrument display • P319 Thru-hull Depth transducer
	i50 Speed	E70058	i50 Speed SeaTalk ^{ng} instrument display
	i50 Speed Thru-hull system pack	E70147	<ul style="list-style-type: none"> • i50 Speed SeaTalk^{ng} instrument display • P120 Thru-hull Speed and Temp transducer
	i50 Tridata	E70060	i50 Tridata SeaTalk ^{ng} instrument display

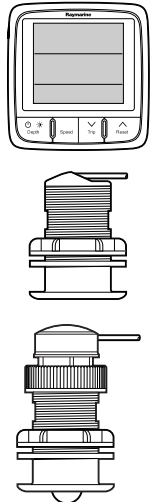
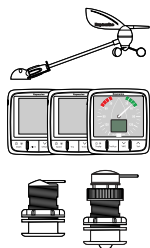
Item	Model	Part number	Hardware
	i50 Tridata Thru-hull system pack	E70149	<ul style="list-style-type: none"> • i50 Tridata SeaTalk^{ng} instrument display • P319 Thru-hull Depth transducer • P120 Thru-hull Speed and Temp transducer
	i50 & i60 Depth, Speed & Wind system pack	E70153	<ul style="list-style-type: none"> • i50 Depth SeaTalk^{ng} instrument display • P319 Thru-hull Depth transducer • i50 Speed SeaTalk^{ng} instrument display • P120 Thru-hull Speed and Temp transducer • i60 Wind SeaTalk^{ng} instrument display • Short arm wind vane transducer

Document illustrations

Your product may differ slightly from that shown in the illustrations in this document, depending on product variant and date of manufacture.

All images are provided for illustration purposes only.

Product documentation

The following documentation is applicable to your product:

Handbooks

Description	Part number
i50 Installation and operation instructions Installation and operation instructions for the i50 instrument display	81341 / 88009
i50 Mounting template Surface mounting template for the i50 instrument display	87130
Rotavecta Installation instructions Installation instructions for the Rotavecta wind transducer	87221 / 88036
Short & long arm wind vane Installation instructions Installation instructions for the short and long arm wind vane transducers	87220 / 88035
Depth and Speed Transducer installation instructions Installation instructions for speed and depth transducers, as supplied with your transducer	

2.2 Parts supplied

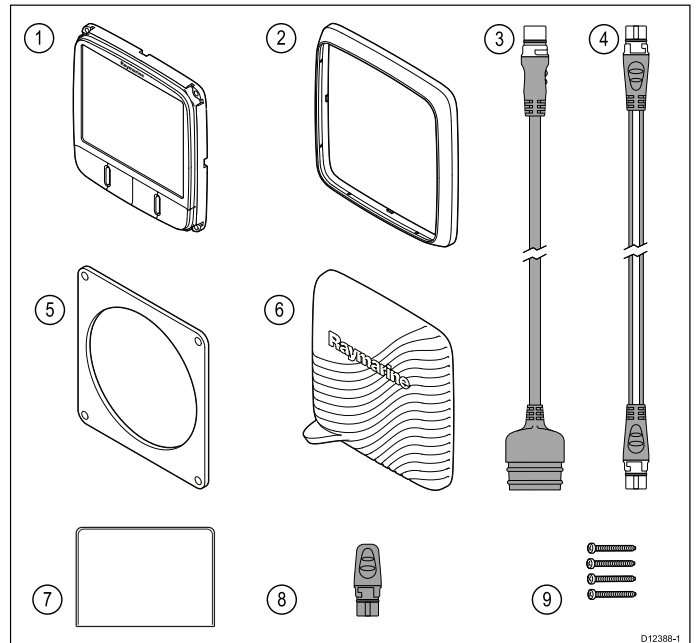

1	i50 instrument
2	Front bezel
3	SeaTalk to SeaTalk ^{ng} adaptor cable
4	SeaTalk ^{ng} spur cable
5	Gasket
6	Sun cover
7	Documentation pack
8	SeaTalk ^{ng} blanking plug
9	4 x fixing screws

2.3 i50 Product overview

The i50 range of SeaTalk^{ng} instrument displays can be connected directly to the relevant transducers. The data can be transmitted on the SeaTalk^{ng} network to other compatible displays.

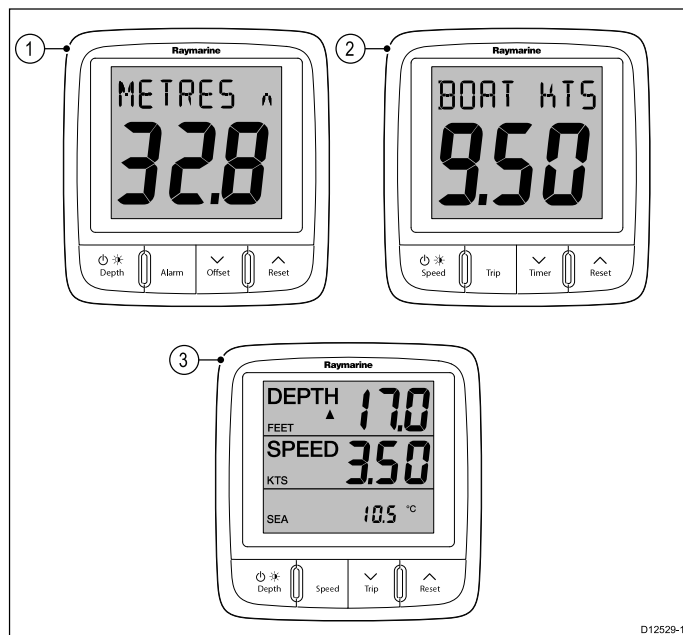

1. i50 Depth
2. i50 Speed
3. i50 Tridata

The i50 instrument display range offers the following features:

- Integrates with Raymarine autopilots and navigation equipment on the SeaTalk^{ng} network
- Surface mountable
- Extra large (28 mm max) digits
- Provides good visibility in all lighting conditions
- Low power consumption

Chapter 3: Planning the installation

Chapter contents

- [3.1 Installation checklist on page 16](#)
- [3.2 Compatible transducers on page 16](#)
- [3.3 Typical systems on page 18](#)
- [3.4 System protocols on page 20](#)
- [3.5 Tools required on page 20](#)
- [3.6 Selecting a display location on page 21](#)
- [3.7 Product dimensions on page 22](#)
- [3.8 Selecting a transducer location on page 22](#)

3.1 Installation checklist

Installation includes the following activities:

Installation Task	
1	Plan your system.
2	Obtain all required equipment and tools.
3	Site all equipment.
4	Route all cables.
5	Drill cable and mounting holes.
6	Make all connections into equipment.
7	Secure all equipment in place.
8	Power on and test the system.

Schematic diagram

A schematic diagram is an essential part of planning any installation. It is also useful for any future additions or maintenance of the system. The diagram should include:

- Location of all components.
- Connectors, cable types, routes and lengths.

3.2 Compatible transducers

Instrument Depth transducers

The depth transducers listed below are compatible with the following instrument displays:

- i40 Depth / i40 Bidata
- i50 Depth / i50 Tridata
- i70 via iTC-5 converter

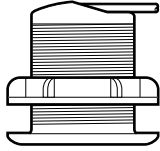
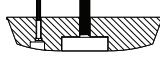
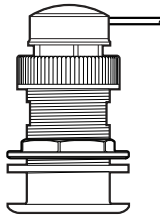
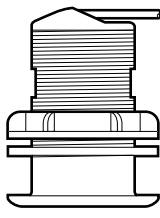
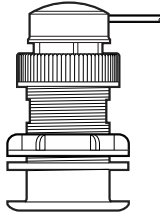
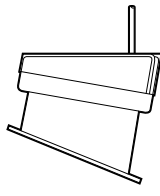
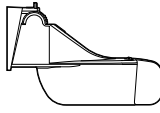
Part number	Image	Mounting	Housing
E26009		Thru-hull	P7
E26019-PZ		Thru-hull	B45 (including fairing block)
M78717		Thru-hull	B17
M78713-PZ		Thru-hull	P319
E26030		Thru-hull	P17
E26001-PZ		In-hull	P79
E26027-PZ		Transom mount	P66

Instrument Speed and Temperature transducers

The speed and temperature transducers listed below are compatible with the following instrument displays:

- i40 Speed / i40 Bidata
- i50 Speed / i50 Tridata
- i70 via iTC-5 converter

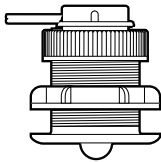
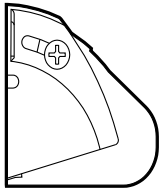
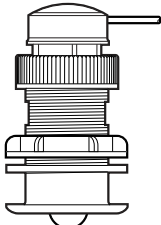
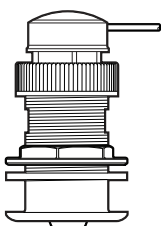
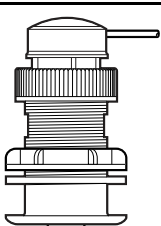
Part number	Image	Mounting	Housing
E26008		Thru-hull	P371
E26005		Transom mount	ST69
E26031		Thru-hull	P120 / ST800
M78716		Thru-hull	B120
E25025		Thru-hull	P17

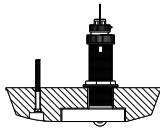
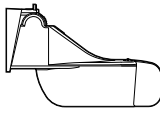
Part number	Image	Mounting	Housing
A26044		Thru-hull	B744VL (including fairing block)
E26028-PZ		Transom mount	P66

Instrument Depth, Speed and Temperature (DST) transducers

The DST transducers listed below are compatible with the following instrument displays:

- i40 Depth / i40 Speed / i40 Bidata
- i50 Depth i50 Speed / i50 Tridata
- i70 via iTC-5 converter

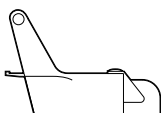
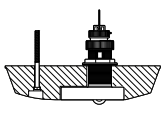
Part number	Image	Mounting	Housing
E26006-PZ		Transom mount	P66 / ST40
A26043		Thru-hull	B744V (including fairing block)

3.3 Typical systems

The instrument range can be connected directly to a SeaTalk^{ng} network. The instrument range can also be connected to a SeaTalk system using the SeaTalk to SeaTalk^{ng} adaptor cable.

Basic SeaTalk^{ng} system example

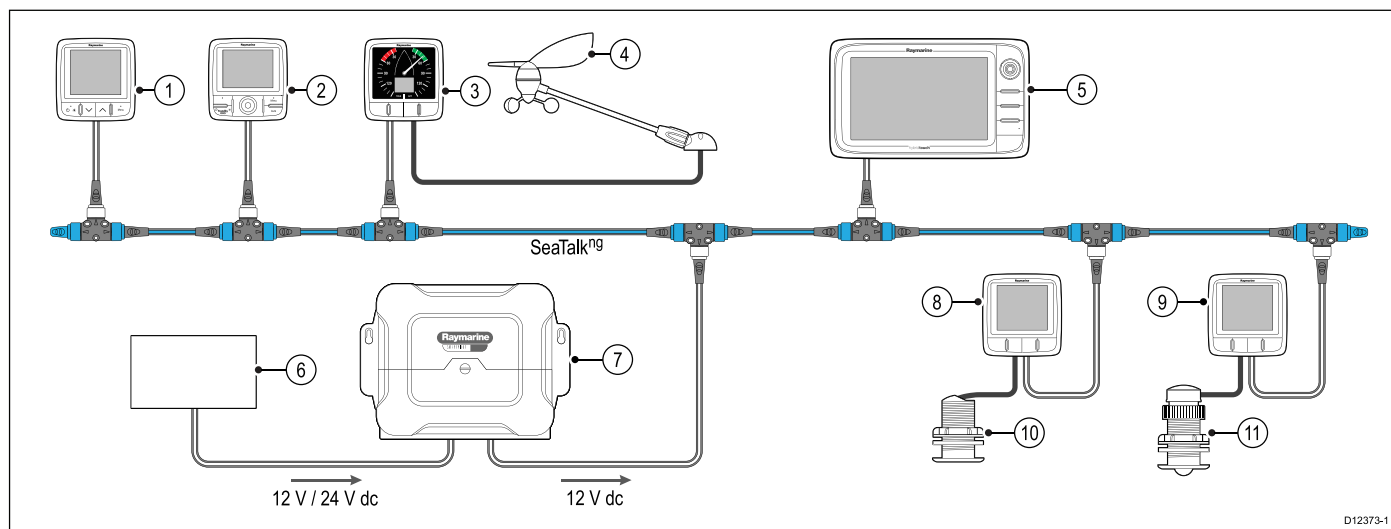

D12373-1

1	SeaTalk ^{ng} instrument display
2	SeaTalk ^{ng} pilot controller
3	i60 Wind instrument
4	Raymarine wind vane transducer
5	Raymarine multifunction display
6	12 / 24 V dc power supply
7	Raymarine course computer (providing 12 V dc power supply to the SeaTalk ^{ng} network.)
8	i50 Speed instrument
9	i50 Depth instrument
10	Speed transducer
11	Depth transducer

Extended SeaTalk^{ng} system example

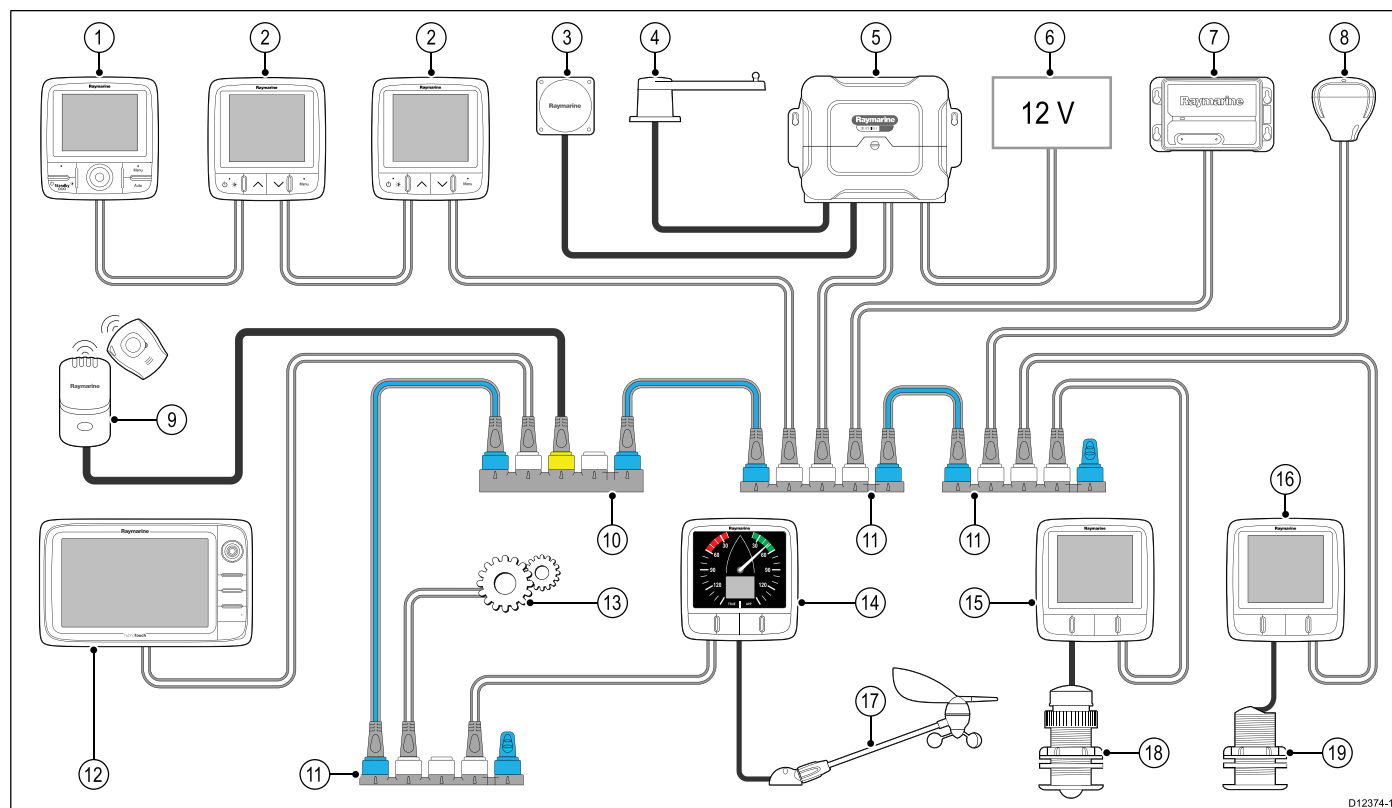

D12374-1

1	SeaTalk ^{ng} pilot controller
2	SeaTalk ^{ng} instrument displays
3	Fluxgate compass
4	Rudder reference
5	Raymarine course computer (providing 12 V dc power supply to SeaTalk ^{ng} network.)
6	12 / 24 V dc power supply
7	Raymarine AIS transceiver
8	Raymarine SeaTalk ^{ng} GPS
9	Man over board
10	SeaTalk to SeaTalk ^{ng} converter
11	SeaTalk ^{ng} 5 way blocks
12	Raymarine multifunction display
13	Engine data (via devicenet adaptor cable.)
14	i60 Wind instrument
15	i50 Depth instrument
16	i50 Speed instrument
17	Raymarine wind vane transducer
18	Depth transducer
19	Speed transducer

3.4 System protocols

Your product can be connected to various products and systems to share information and so improve the functionality of the overall system. These connections may be made using a number of different protocols. Fast and accurate data collection and transfer is achieved by using a combination of the following data protocols:

- SeaTalk^{ng}
- NMEA 2000
- SeaTalk

Note: You may find that your system does not use all of the connection types or instrumentation described in this section.

Seatalk^{ng}

SeaTalk^{ng} (Next Generation) is an enhanced protocol for connection of compatible marine instruments and equipment. It replaces the older SeaTalk and SeaTalk² protocols.

SeaTalk^{ng} utilizes a single backbone to which compatible instruments connect using a spur. Data and power are carried within the backbone. Devices that have a low draw can be powered from the network, although high current equipment will need to have a separate power connection.

SeaTalk^{ng} is a proprietary extension to NMEA 2000 and the proven CAN bus technology. Compatible NMEA 2000 and SeaTalk / SeaTalk² devices can also be connected using the appropriate interfaces or adaptor cables as required.

NMEA 2000

NMEA 2000 offers significant improvements over NMEA 0183, most notably in speed and connectivity. Up to 50 units can simultaneously transmit and receive on a single physical bus at any one time, with each node being physically addressable. The standard was specifically intended to allow for a whole network of marine electronics from any manufacturer to communicate on a common bus via standardized message types and formats.

SeaTalk

SeaTalk is a protocol which enables compatible instruments to connect to each other and share data.

The SeaTalk cable system is used to connect compatible instruments and equipment. The cable carries power and data and enables connection without the need for a central processor.

Additional instruments and functions can be added to a SeaTalk system, simply by plugging them into the network. SeaTalk equipment can also communicate with other non-SeaTalk equipment via the NMEA 0183 standard, provided a suitable interface is used.

3.5 Tools required

Tools required for installation

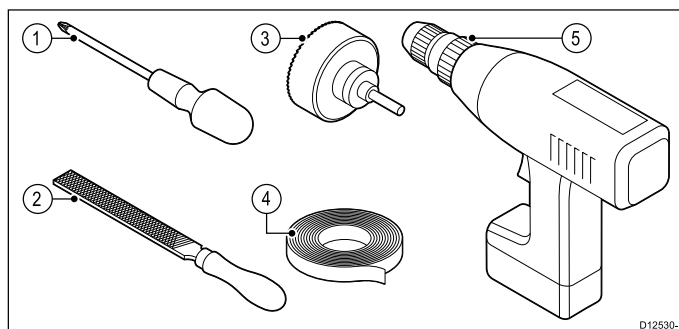

1	Pozi-drive screwdriver
2	File
3	92 mm (3.62 in) hole cutter
4	Adhesive tape
5	Power drill

3.6 Selecting a display location

Viewing angle



Warning: Potential ignition source
This product is NOT approved for use in hazardous/flammable atmospheres. Do NOT install in a hazardous/flammable atmosphere (such as in an engine room or near fuel tanks).

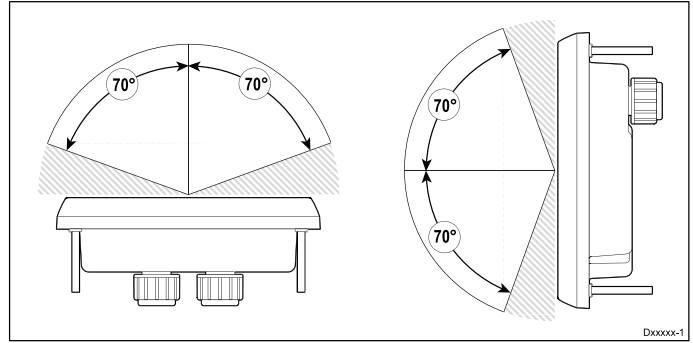

General location requirements

When selecting a location for the unit it is important to consider a number of factors.

Ventilation requirements

To provide adequate airflow:

- Ensure that equipment is mounted in a compartment of suitable size.
- Ensure that ventilation holes are not obstructed.
- Ensure adequate separation of equipment.

Mounting surface requirements

Ensure units are adequately supported on a secure surface. Do NOT mount units or cut holes in places which may damage the structure of the vessel.

Cable routing requirements

Ensure the unit is mounted in a location which allows proper routing and connection of cables:

- Minimum cable bend radius of 100 mm (3.94 in) is required unless otherwise stated.
- Use cable supports to prevent stress on connectors.

Electrical interference

Select a location that is far enough away from devices that may cause interference, such as motors, generators and radio transmitters/receivers.

Magnetic compass

When choosing a suitable location you should aim to maintain the maximum possible distance between the unit and any compasses.

To prevent potential interference with the vessel's magnetic compasses, ensure that a minimum distance of 230 mm (9 in) between the unit and any installed compasses is maintained.

Viewing angle considerations

As display contrast, color and night mode performance are all affected by the viewing angle, Raymarine recommends you temporarily power up the display when planning the installation, to enable you to best judge which location gives the optimum viewing angle.

3.7 Product dimensions

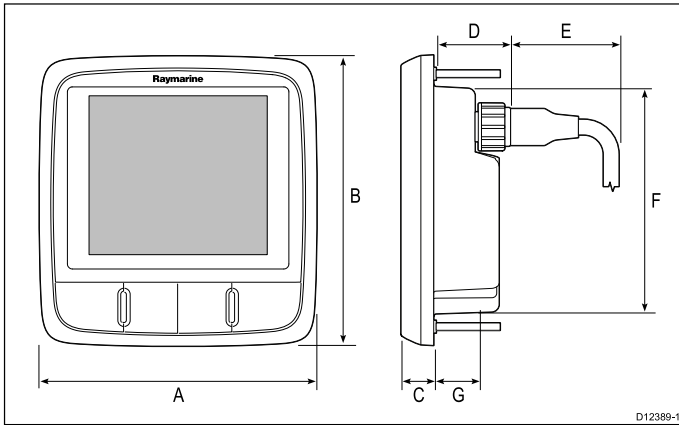

D12389-1

A	110 mm (4.22")
B	115 mm (4.52")
C	14 mm (0.55")
D	30 mm (1.18")
E	35 mm (1.38")
F	90 mm (3.54")
G	17 mm (0.67")

3.8 Selecting a transducer location

General speed and depth transducer location requirements

When selecting a location for your transducer it is important to consider a number of factors.

The transducer should be mounted within the clear water flow areas indicated by the shaded areas in the image below.

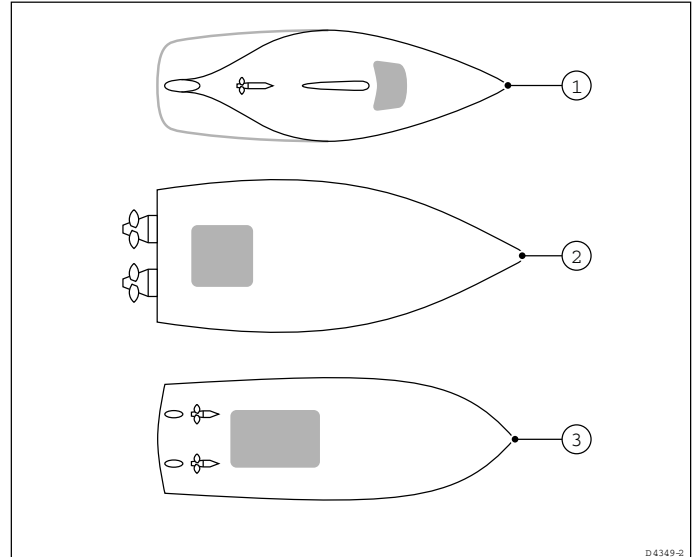

D4349-2

1	Sailing vessel
2	Planing power vessel
3	Displacement power vessel

Each transducer should also:

- Be ahead of the propellers (by a minimum of 10% of the water line length).
- Be at least 150 mm (6 in) away from the keel (ideally ahead of the keel on a sailing yacht).
- Be as near as possible to the center line of the vessel.
- Be clear of other through-hull fittings or projections.
- Have sufficient clearance inside the hull to fit the nut.
- Have 100 mm (4 in) of headroom to allow for withdrawal.

Note: In addition to the above requirements, the depth transducer must be mounted within 10° of the vertical.

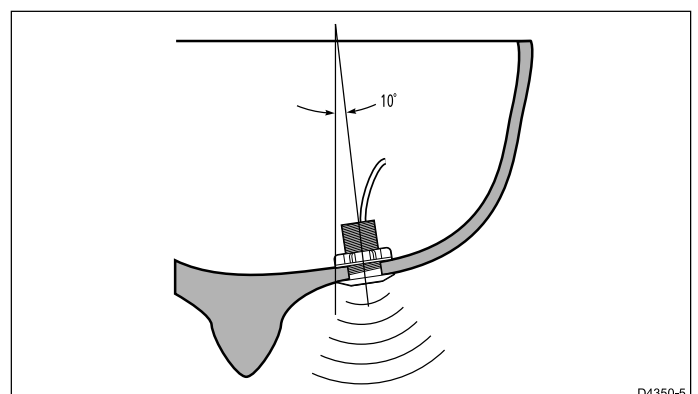

D4350-5

Chapter 4: Cables and connections

Chapter contents

- [4.1 General cabling guidance on page 24](#)
- [4.2 Power connection on page 24](#)
- [4.3 SeaTalk^{ng} connections on page 25](#)
- [4.4 Transducer connections on page 26](#)
- [4.5 iTC-5 connection on page 27](#)
- [4.6 SeaTalk connection on page 27](#)
- [4.7 NMEA2000 connection on page 28](#)

4.1 General cabling guidance

Cable types and length

It is important to use cables of the appropriate type and length

- Unless otherwise stated use only standard cables of the correct type, supplied by Raymarine.
- Ensure that any non-Raymarine cables are of the correct quality and gauge. For example, longer power cable runs may require larger wire gauges to minimize voltage drop along the run.

Routing cables

Cables must be routed correctly, to maximize performance and prolong cable life.

- Do NOT bend cables excessively. Wherever possible, ensure a minimum bend diameter of 200 mm (8 in) / minimum bend radius of 100 mm (4 in).

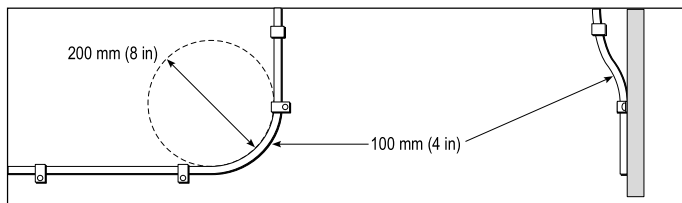

- Protect all cables from physical damage and exposure to heat. Use trunking or conduit where possible. Do NOT run cables through bilges or doorways, or close to moving or hot objects.
- Secure cables in place using tie-wraps or lacing twine. Coil any extra cable and tie it out of the way.
- Where a cable passes through an exposed bulkhead or deckhead, use a suitable watertight feed-through.
- Do NOT run cables near to engines or fluorescent lights.

Always route data cables as far away as possible from:

- other equipment and cables,
- high current carrying ac and dc power lines,
- antennae.

Strain relief

Ensure adequate strain relief is provided. Protect connectors from strain and ensure they will not pull out under extreme sea conditions.

Cable shielding

Ensure that all data cables are properly shielded that the cable shielding is intact (e.g. hasn't been scraped off by being squeezed through a tight area).

4.2 Power connection

Power is supplied to the product over the SeaTalk^{ng} network.

A SeaTalk^{ng} system requires one 12 V dc supply, connected to the SeaTalk^{ng} backbone. This can be provided:

- By a battery via the distribution panel, or
- From a Raymarine course computer, via a SeaTalk or a SeaTalk^{ng} system.



Warning: Grounding not required

This product is fully insulated and does NOT require separate grounding.



Warning: Positive ground systems

Do not connect this unit to a system which has positive grounding.

Power connection

Direct power connection

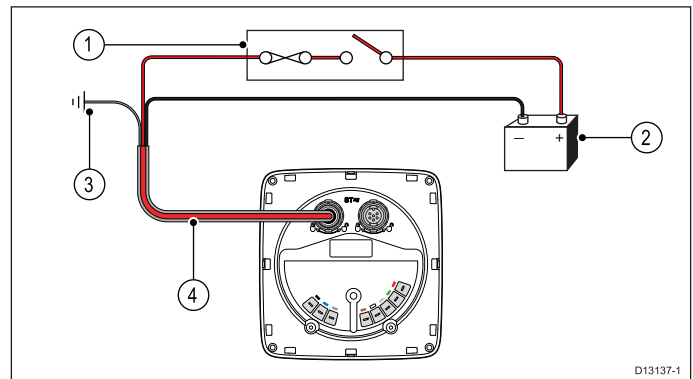

1	3 A circuit breaker or fuse
2	12 V dc vessel power supply
3	Vessel's RF ground
4	SeaTalk ^{ng} power cable

Example

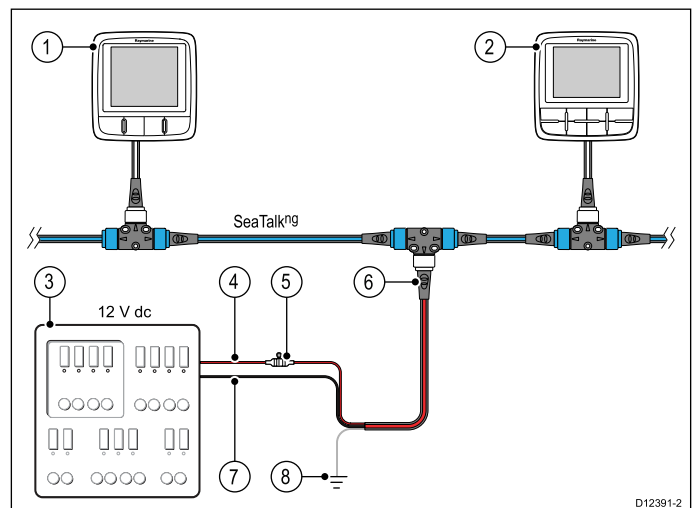

1	SeaTalk ^{ng} instrument
2	SeaTalk ^{ng} Pilot controller
3	12 V dc vessel power supply.

4	12 V dc positive (+)
5	In-line 5 A fuse
6	SeaTalk ^{ng} power cable
7	12 V dc negative (-)
8	Vessel's RF ground

SeaTalk^{ng} power protection

The power supply must be protected by a 5 A fuse or a circuit breaker providing equivalent protection.

Raymarine recommends that the power is connected to a SeaTalk^{ng} system in such a way that the current drawn on each side of the power connection point is equal.

SeaTalk^{ng} power cables

Part number	Description
A06049	SeaTalk ^{ng} power cable

4.3 SeaTalk^{ng} connections

The unit has 2 x SeaTalk^{ng} connectors on the rear for connecting to a SeaTalk^{ng} network.

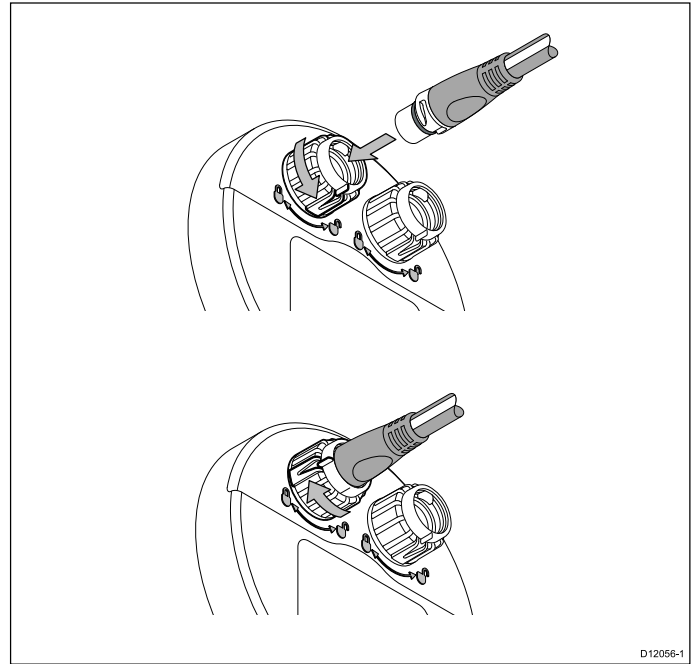

Connecting SeaTalk^{ng} cables

1. Rotate the locking collar on the back of the unit to the UNLOCKED position.
2. Ensure the spur cable end connector is correctly oriented.
3. Fully insert the cable connector.
4. Rotate locking collar clockwise (2 clicks) until it snaps into the LOCKED position.

4.4 Transducer connections

i50 Depth connection

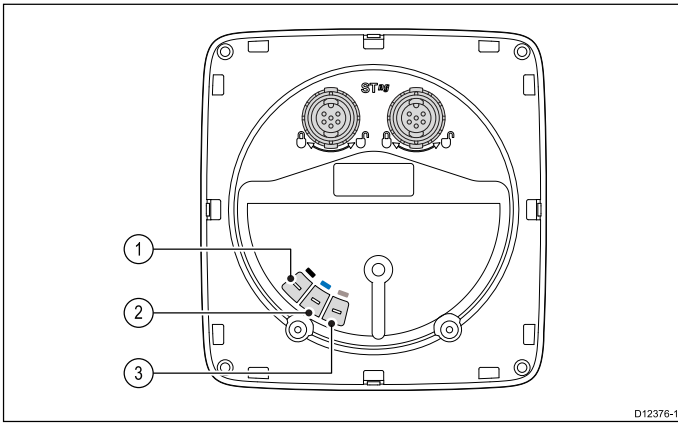

D12376-1

Item	Cable color	Signal name
1	Black	Piezoceramic -
2	Blue	Piezoceramic +
3	Screen	0 V (shield)

i50 Speed connection

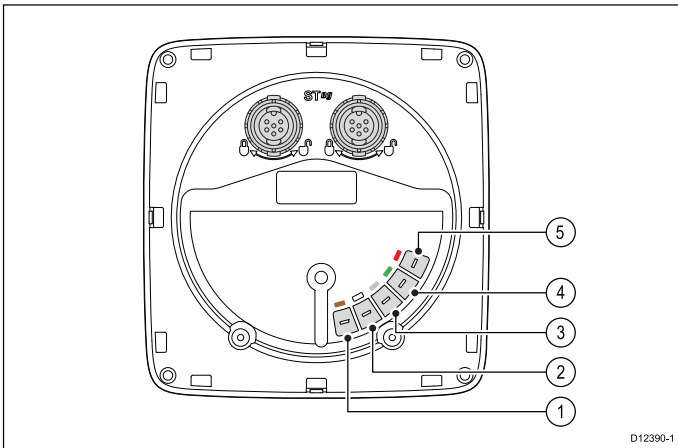

D12390-1

Item	Cable color	Signal name
1	Brown	Temperature 0 V
2	White	Temperature (signal)
3	Screen	Speed 0 V (shield)
4	Green	Speed (signal)
5	Red	Speed V+

i50 Tridata connection

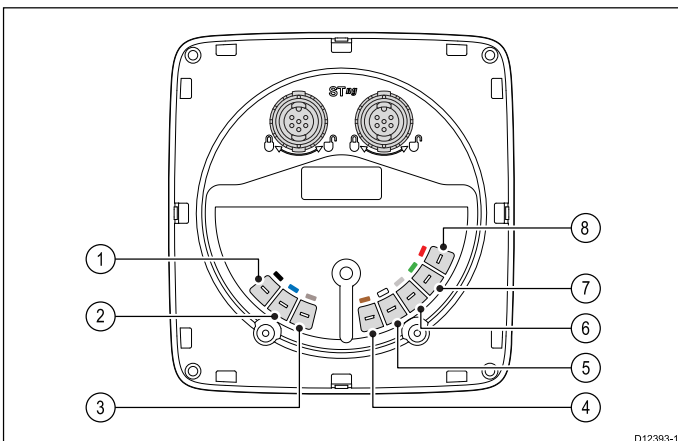

D12393-1

Item	Cable color	Signal name
1	Black (Depth)	Piezoceramic -
2	Blue (Depth)	Piezoceramic +
3	Screen (Depth)	0 V (shield)
4	Brown (Speed)	Temperature 0 V
5	White (Speed)	Temperature (signal)
6	Screen (Speed)	Speed 0 V (shield)
7	Green (Speed)	Speed (signal)
8	Red (Speed)	Speed V+

Making transducer connections

Although the transducer cable is fitted with spade connectors for direct connection to the rear of the unit, it may be necessary to remove these to facilitate installation, e.g. if the cable has to be routed through narrow apertures. 1/8th spade terminals will be required (not supplied), to replace those removed. When fitting the new spade connectors, prepare the cables as detailed below:

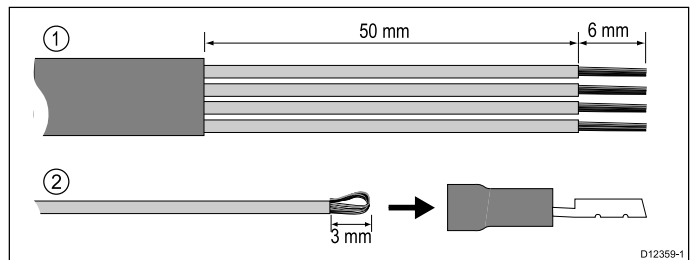

D12359-1

1. Prepare the cable as shown in 1 above.
2. Fold back the wire strands and insert into the new spade connector as shown in 2 above.
3. Ensure the wire strands do not extend beyond the rear of the spade connector insulation.
4. Crimp the connector to the wire.

4.5 iTC-5 connection

Transducers can be connected to a SeaTalk^{ng} network using Raymarine's Instrument transducer converter (iTC-5) and an i70 instrument, the data can then be repeated on an i50 / i60 unit.

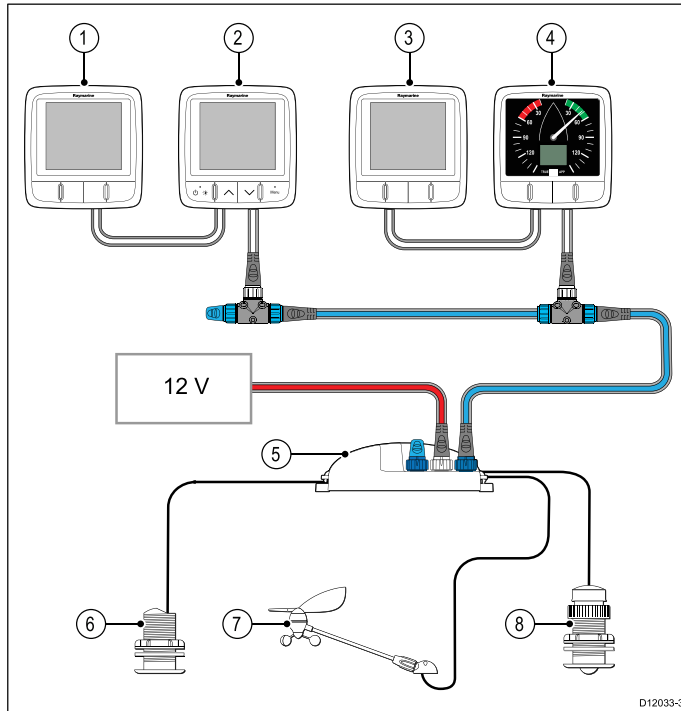

1	i50 Depth (Repeater)
2	i70 Instrument (Master)
3	i50 Speed (Repeater)
4	i60 Wind (Repeater)
5	iTC-5
6	Depth transducer
7	Wind vane transducer
8	Speed transducer

Note: Transducers connected to the iTC-5 must be calibrated using an i70 (master) unit. Transducers connected to the iTC-5 cannot be calibrated using an i50 / i60.

Making iTC-5 transducer connections

For instructions on connecting transducers to your iTC-5 refer to the iTC-5 handbook.

4.6 SeaTalk connection

Connections to an existing SeaTalk system must be made using a SeaTalk to SeaTalk^{ng} adaptor cable.

Basic SeaTalk system example

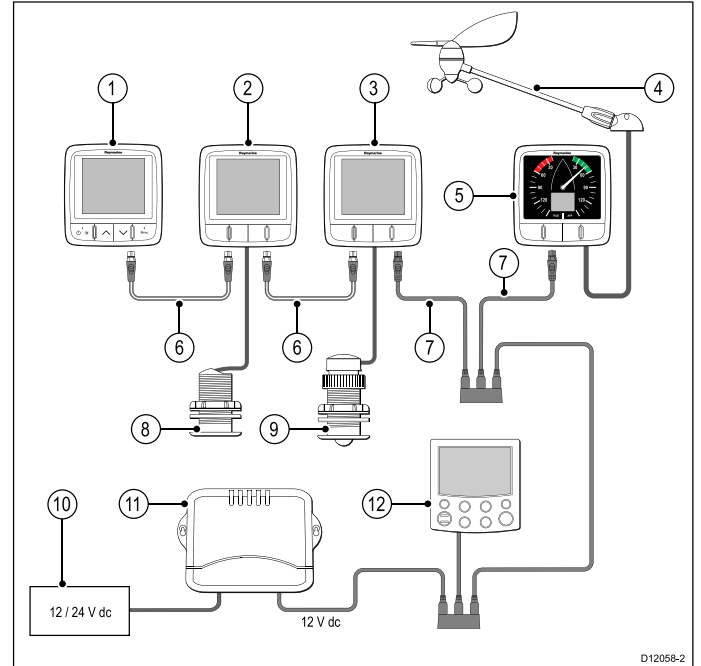

1	i70 Instrument display (SeaTalk ^{ng})
2	i50 Speed instrument (SeaTalk ^{ng})
3	i50 Depth instrument (SeaTalk ^{ng})
4	Raymarine wind vane transducer
5	i60 Wind instrument (SeaTalk ^{ng})
6	SeaTalk ^{ng} cables
7	SeaTalk to SeaTalk ^{ng} adaptor cables
8	Speed transducer
9	Depth transducer
10	12 / 24 V dc power supply
11	SeaTalk Course computer (providing 12 V dc power to SeaTalk network.)
12	ST6002 pilot controller (SeaTalk)

SeaTalk power protection

The power supply must be protected by a 5 A fuse or a circuit breaker providing equivalent protection.

Raymarine recommends that the power is connected to a SeaTalk system in such a way that the current drawn on each side of the power connection point is equal.

SeaTalk power cables

Part number	Description
D229	SeaTalk power cable.

4.7 NMEA2000 connection

You can either:

- Use your SeaTalk^{ng} backbone and connect each NMEA2000 device on a spur, OR
- connect the instrument display on a spur into an existing NMEA2000 backbone.

Important: You cannot have any 2 terminated backbones connected together, unless you have an isolation gateway between the two backbones.

Connecting NMEA2000 equipment to the SeaTalk^{ng} backbone

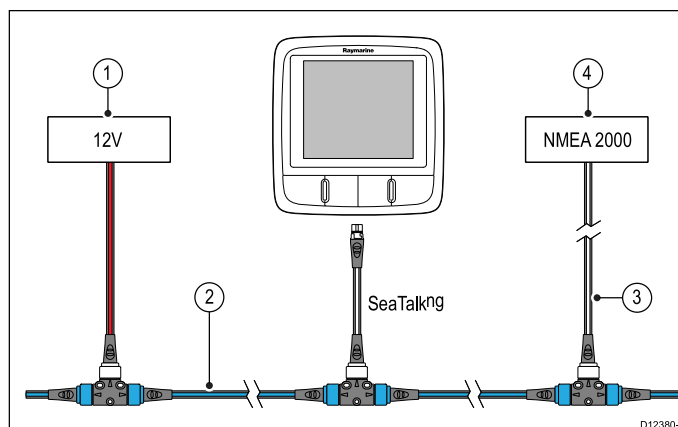

1. 12 V dc power supply into backbone.
2. SeaTalk^{ng} backbone.
3. SeaTalk^{ng} to DeviceNet adaptor cable.
4. NMEA2000 equipment.

Connecting the unit to an existing NMEA2000 (DeviceNet) backbone

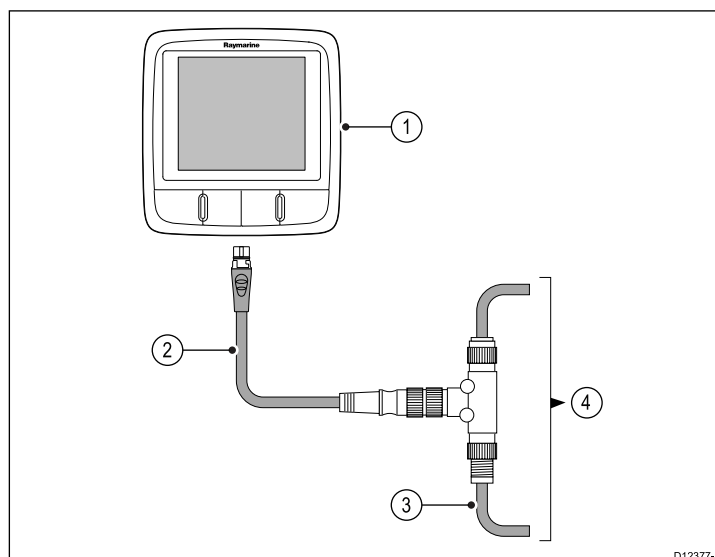

1. SeaTalk^{ng} instrument display
2. SeaTalk^{ng} to DeviceNet adaptor cable.
3. DeviceNet backbone.
4. NMEA2000 equipment.

Chapter 5: Mounting

Chapter contents

- [5.1 Mounting on page 30](#)
- [5.2 Front bezel on page 31](#)

5.1 Mounting

Pre-mounting check

The product is designed to be surface mounted. Before mounting the unit, ensure you have:

- Selected a suitable location.
- Identified the cable connections and route that the cables will take.
- Detached the front bezel.
- Remove the keypad mat.

Mounting diagram

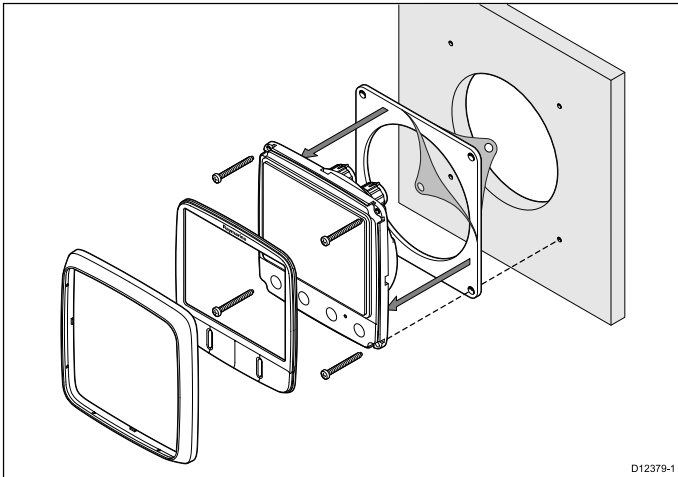

Mounting instructions

1. Check the selected location for the unit, a clear, flat area with suitable clearance behind the panel is required.
2. Fix the mounting template supplied with the product, to the selected location, using masking or self adhesive tape.
3. If possible use an appropriate size hole cutting saw and cut out the centre hole cut out area as indicated on the mounting template, or
4. Using a suitable hole cutting saw, make pilot holes in each corner of the cut out area and using a jigsaw cut along the inside edge of the cut out line.
5. Ensure that the unit fits into the removed area and then file around the cut edge until smooth.
6. Drill any required holes as indicated on the mounting template for the securing screws.
7. Connect the relevant cables to the unit.
8. Peel the backing off of the supplied gasket and place the adhesive side of the gasket onto the display unit and press firmly onto the flange.
9. Slide the unit into place and secure using the screws provided.
10. Refit keypad mat and front bezel.

Note: The supplied gasket provides a seal between the unit and a suitably flat and stiff mounting surface or binnacle. The gasket should be used in all installations. It may also be necessary to use a marine-grade sealant if the mounting surface or binnacle is not entirely flat and stiff or has a rough surface finish.

Note: Drill, tap size and tightening torques are dependant upon the material type and thickness of the mounting surface.

5.2 Front bezel

Removing the front bezel

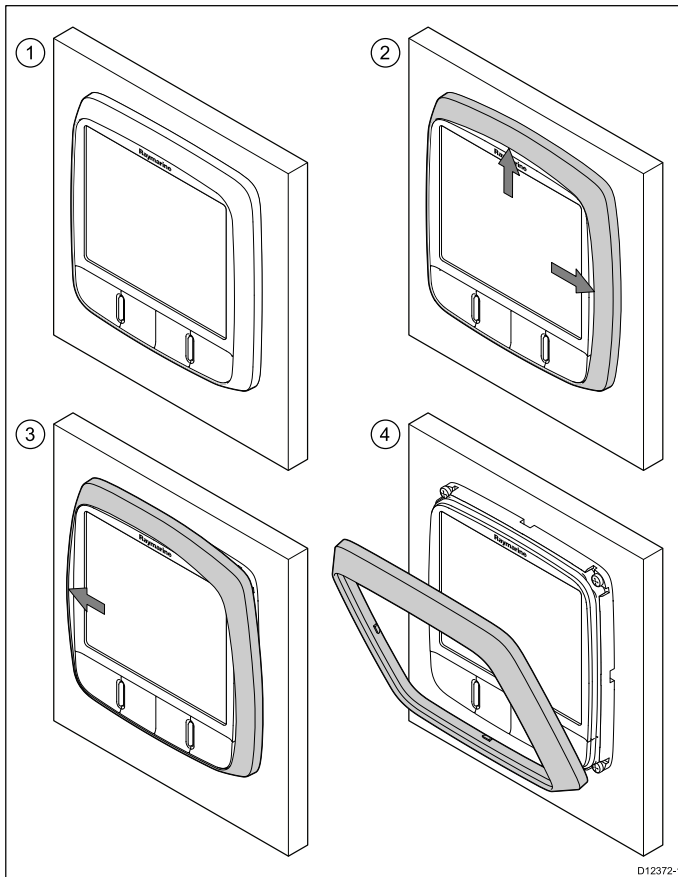

Note: Use care when removing the bezel. Do not use any tools to lever the bezel, doing so may cause damage.

1. Using your fingers pull the bezel away from the unit at the top and side, as shown in 2.
The bezel will start to come away from the unit at the top and side.
2. Now pull the bezel away from the unit on the opposite side, as shown in 3.
The bezel will now come free from the unit, as shown in 4.

Chapter 6: i50 Depth

Chapter contents

- 6.1 i50 Depth operation on page 34
- 6.2 i50 Depth controls on page 34
- 6.3 Power on page 35
- 6.4 Data master on page 35
- 6.5 Calibration on page 36
- 6.6 User Calibration - i50 Depth on page 36
- 6.7 Intermediate calibration — i50 Depth on page 37
- 6.8 Dealer calibration — i50 Depth on page 38
- 6.9 Using the depth pages on page 39
- 6.10 Viewing the depth offset on page 39
- 6.11 Alarms on page 40
- 6.12 Illumination on page 41

6.1 i50 Depth operation

When connected to the relevant depth transducer, your i50 depth instrument:

- Provides current depth information, in either feet (ft), metres (M) or fathoms (FA).
- Records the minimum and maximum depth encountered during the period the unit is switched on.
- Enables you to define alarm thresholds for shallow alarm, deep alarm, shallow anchor alarm and deep anchor alarm.
- Enables you to see what offset has been applied to the depth reading.

Note: Depth information is obtained from the depth transducer connected to the unit. However, when the instrument is connected to a SeaTalk network, which contains a compatible sonar module (fishfinder) the depth information is provided by the sonar module, whilst it is switched on.

It should be noted that:

- The required depth units are selected during User calibration.
- Up / Down depth-trend arrows are displayed, if the seabed is rising or falling.
- If for any reason depth information is lost, the depth title will flash and the displayed value will be the last known depth reading.

6.2 i50 Depth controls

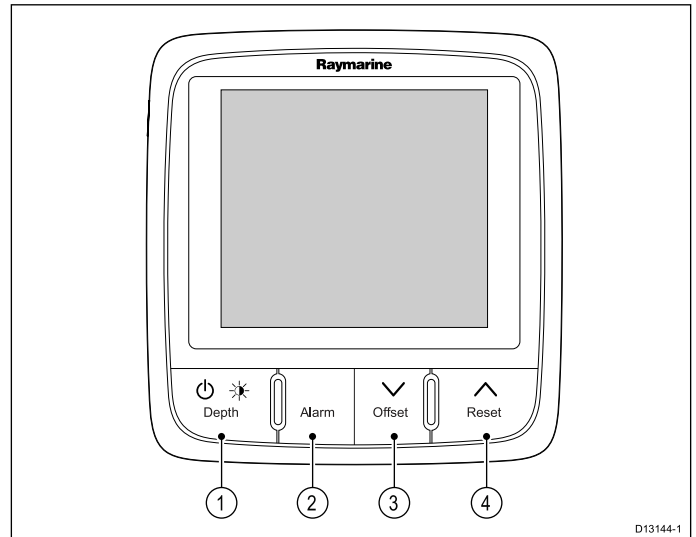

1	Depth / Power — Select to access depth information, adjust backlight, adjust contrast and power the display On and Off
2	Alarm — Select to access alarm levels and alarm settings
3	Offset / Down — Select to access depth offset settings. Use to move down through menu options or to decrease numeric values
4	Reset / Up — Select and hold down for 3 seconds to reset data to current values. Use to move up through menu options or to increase numeric values

6.3 Power

Powering on the unit

With power to the unit turned on but the unit switched off:

1. Press and hold the **Power** button until the unit powers on and data is displayed (approximately 2 seconds).

Note: When power to the unit is turned on the unit will switch on automatically.

Powering off the unit

1. Press and hold the **Power** button until the power count down timer is displayed and reaches zero (approximately 6 to 8 seconds).

6.4 Data master

Where a system contains more than one unit capable of displaying a data type, the unit physically connected to the transducer must be set as the data master and any other units set as a repeater.

Checking i50 Depth software version and status

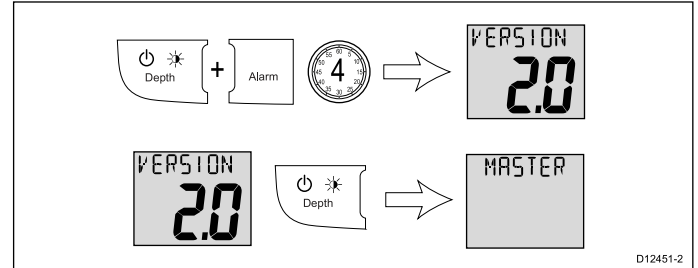

During normal operation:

1. Press and hold the **Depth** and **Alarm** buttons at the same time for approximately 4 seconds, until the Software Version page is displayed.
2. Press the **Depth** button to display the Instrument Status page.
Master (transducer connected) or Repeater (No transducer connected).
3. To change the status:
 - i. Press the **Offset** and **Reset** buttons at the same time.
The status will flash.
 - ii. Press either the **Offset** or **Reset** to change the status between Master or Repeater.
 - i. Press the **Offset** and **Reset** buttons at the same time to confirm the status.
4. To exit the Intermediate calibration settings at any time, press and hold the **Depth** and **Alarm** buttons at the same time for approximately 4 seconds to return to normal operation.

6.5 Calibration

Before first use calibration procedures must be carried out to ensure optimum performance of the instrument with the vessel.

The calibration procedures are:

- User calibration
- Intermediate calibration
- Dealer calibration

6.6 User Calibration - i50 Depth

User calibration options include:

- Units for depth readings — Assigns the unit of measure used for depth related readings.
- * Depth offset — Assigns an offset to the depth reading.

Note: * These settings are only available on displays when the instrument status is set to Master (see Intermediate Calibration for details of changing the display to be Master or Repeater).

Accessing the User Calibration Menu

During normal operation:

1. Press and hold the **Depth** and **Alarm** buttons at the same time for approximately 2 seconds, until the User Calibration page is displayed.



Note: The user calibration page will time-out after 8 seconds of inactivity.

2. Use the **Depth** button to cycle through the available settings.

Note: To exit the user calibration pages at any time, press and hold the **Depth** and **Alarm** buttons at the same time for approximately 2 seconds.

Selecting the unit of measure for depth readings

From the **User Calibration Menu**:

1. Press the **Depth** button until the **Depth Units** page is displayed (1 press from the **User Calibration** entry page).

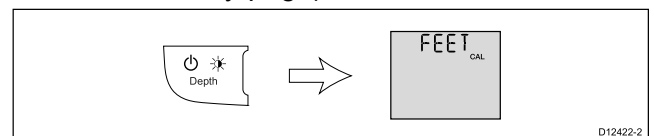

2. Use the **Offset** and **Reset** buttons to select the required unit of measurement for depth readings. The units of measure available for depth readings are:

- FEET (default)
- METRES
- FATHOMS

Note: To exit the user calibration pages at any time, press and hold the **Depth** and **Alarm** buttons at the same time for approximately 2 seconds.

Depth Offset

Depths are measured from the transducer to the sea bed, but you can apply an offset value to the depth data, so that the displayed depth reading represents the depth to the sea bed from either the keel or the waterline.

Before attempting to set a waterline or keel offset, find out the vertical separation between the transducer and either the waterline or the bottom of the keel on your vessel, as appropriate. Then set the appropriate depth offset value.

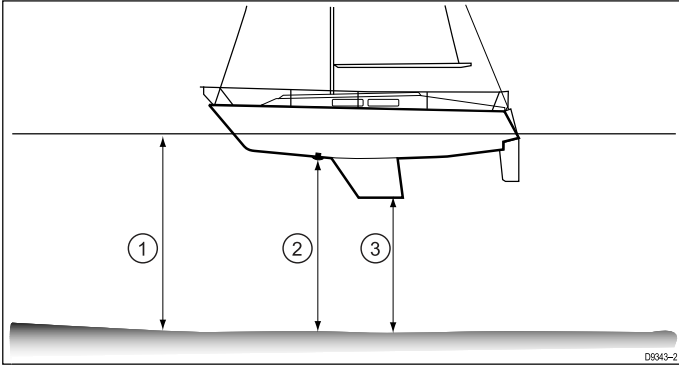

1	Waterline offset
2	Transducer / Zero offset
3	Keel offset

If an offset is not applied, displayed depth readings represent the distance from the transducer to the sea bed.

Applying a Depth Offset

From the **User Calibration Menu**:

1. Press the **Depth** button until the **Depth Offset** page is displayed (2 presses from **User Calibration** entry page).

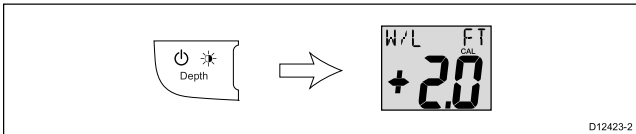

2. Use the **Offset** and **Reset** buttons to select the required depth offset value.

The depth offset can be set to the following values:

- Keel — values between -9.9 to -0.1
- OFFSET (default) (Zero Offset) — 0.0
- W/L (Waterline) — values between 0.1 to 9.9

Note: To exit the user calibration pages at any time, press and hold the **Depth** and **Alarm** buttons at the same time for approximately 2 seconds.

6.7 Intermediate calibration — i50 Depth

Intermediate calibration allows you to:

- Check the instrument software version.
- Check and if necessary set the instrument status as either Master or Repeater.

Checking i50 Depth software version and status

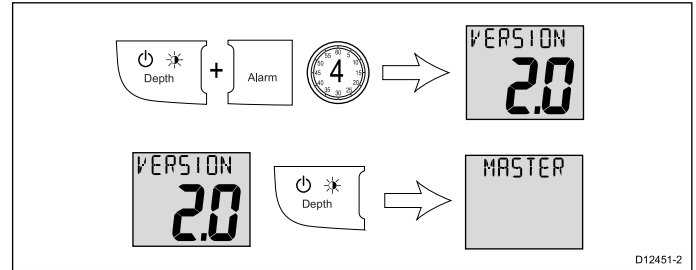

During normal operation:

1. Press and hold the **Depth** and **Alarm** buttons at the same time for approximately 4 seconds, until the Software Version page is displayed.
2. Press the **Depth** button to display the Instrument Status page.
Master (transducer connected) or Repeater (No transducer connected).
3. To change the status:
 - i. Press the **Offset** and **Reset** buttons at the same time.
The status will flash.
 - ii. Press either the **Offset** or **Reset** to change the status between Master or Repeater.
 - iii. Press the **Offset** and **Reset** buttons at the same time to confirm the status.
4. To exit the Intermediate calibration settings at any time, press and hold the **Depth** and **Alarm** buttons at the same time for approximately 4 seconds to return to normal operation.

6.8 Dealer calibration — i50 Depth

Dealer Calibration enables you to set:

- User calibration menu access On (default) and Off.
- Display Response for depth readings — Dictates the rate at which the instrument display responds to changes in depth data.
- Boat show mode On and Off (default) (Boat show mode is only available on displays set as repeaters).
- Reset to factory defaults.

Accessing the Dealer Calibration Menu

During normal operation:

1. Press and hold the **Depth** and **Alarm** buttons at the same time for approximately 14 seconds, until the **Dealer Calibration** page is displayed.

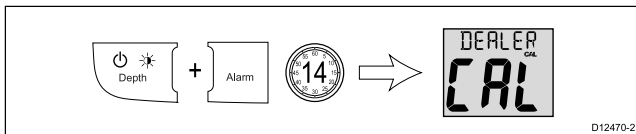

Note: To exit the Dealer Calibration pages at any time, press and hold the **Depth** and **Alarm** buttons at the same time for approximately 2 seconds.

Setting access to the User Calibration Menu

From the Dealer Calibration page:

1. Press the **Offset** and **Reset** buttons at the same time to display the **User Calibration Access** page.

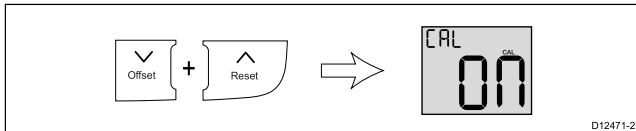

2. Use the **Offset** and **Reset** buttons to switch access to the **User Calibration Menu** On (default) and Off. Selecting Off disables access to the **User Calibration Menu**.

Note: To exit the Dealer Calibration pages at any time, press and hold the **Depth** and **Alarm** buttons at the same time for approximately 2 seconds.

Setting the response delay for depth readings

From the **User Calibration Menu Access** page:

1. Press the **Depth** button until the **Depth Response** page is displayed (1 press from the **User Calibration Menu Access** page).

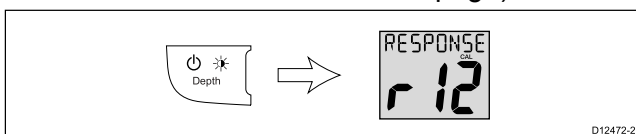

2. Use the **Offset** and **Reset** buttons to adjust the depth response to the required level. The default level is 12. The levels available are 1 to 15 with level 1 being the slowest update rate and level 15 the quickest.

Note: To exit the Dealer Calibration pages at any time, press and hold the **Depth** and **Alarm** buttons at the same time for approximately 2 seconds.

Enabling and disabling Boat Show Mode

From the **User Calibration Menu Access** page:

1. Press the **Depth** button until the **Boat Show Mode** page is displayed (2 presses from **User Calibration Menu Access** page).

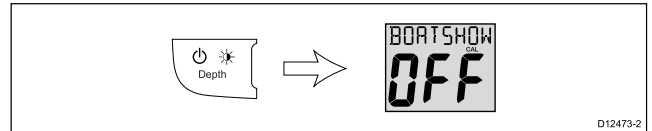

2. Use the **Offset** and **Reset** buttons to switch boat show mode On and Off (default). Selecting On will put the display into boat show mode.

Note: Boat show mode is only suitable for demonstration purposes and should NOT be used whilst your vessel is in use.

Note: To exit the Dealer Calibration pages at any time, press and hold the **Depth** and **Alarm** buttons at the same time for approximately 2 seconds.

Resetting the display to factory defaults

From the **User Calibration Menu Access** page:

1. Press the **Depth** button until the **Factory Defaults** page is displayed (3 presses from **User Calibration Menu Access** page).

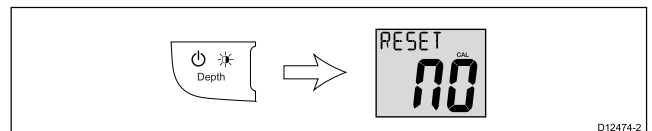

2. To reset the display to factory default settings:
 - i. Use the **Offset** or **Reset** buttons to change the reset option to Yes.
 - ii. Press the **Depth** button to reset your display to factory default settings.
3. After a reset it is recommended that you check the data master status of the display to ensure it is set correctly. Refer to [6.4 Data master](#) for details.

Note: To exit the Dealer Calibration pages at any time, press and hold the **Depth** and **Alarm** buttons at the same time for approximately 2 seconds.

6.9 Using the depth pages

To cycle through the depth pages follow the steps below.

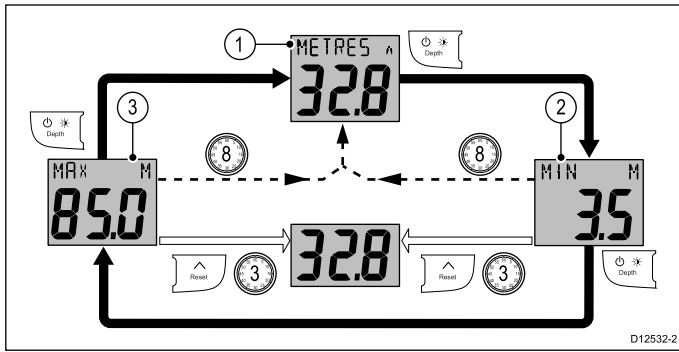

1. Current Depth page
2. * Minimum Depth page
3. * Maximum Depth page

Note: * These pages are temporary pages and will revert back to the Current Depth page after 8 seconds of inactivity.

1. Use the **Depth** button to cycle through the available depth pages.
2. From the Minimum Depth or Maximum Depth page, press and hold the **Reset** button for approximately 3 seconds to reset the reading.

6.10 Viewing the depth offset

To view the offset value currently applied to your instrument follow the steps below.

During normal operation:

1. Press the **Offset** button to display the **Depth offset** page.

The display shows the value of the offset applied and identifies:

- If a positive offset value is applied **W/L** is displayed to denote a waterline offset.
- If a negative offset value is applied **KEEL** is displayed to denote a keel offset.
- If a zero offset value is applied **OFFSET** is displayed to denote that there is a zero offset from the transducer.

Note: Depth offset information is only available on units set as data masters (see *Data master* section for details).

6.11 Alarms

Alarms alert you to a situation or hazard requiring your attention.

You can set up alarms to alert you to certain conditions.

Alarms are raised by system functions, and also external equipment connected to your display.

When an alarm event occurs an audible and visual alarm is activated which indicates the alarm state.

Alarm thresholds can be configured from the relevant alarm page / menu.

Instrument alarms

The alarms available for the i50 Depth and i50 Tridata are listed below.

- Shallow depth alarm
- Deep depth alarm
- Shallow anchor alarm
- Deep anchor alarm

Alarm indications

An alarm event is indicated by both audible and visual warnings.

Shallow alarm



Deep alarm

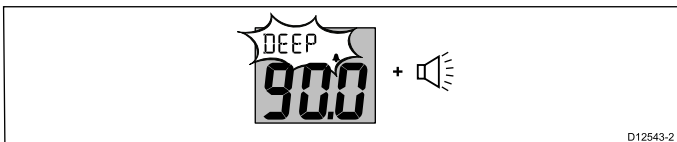

Shallow anchor alarm



Deep anchor alarm

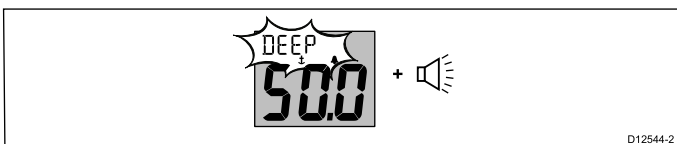

Alarms are sounded when the set alarm threshold value is crossed. Alarms will sound until silenced.

Silencing alarms

1. Press any button to silence an active alarm.

Enabling / Disabling alarms

Alarms can be enabled or disabled at any time.

With the relevant alarm page displayed:

1. Press and hold the **Reset** button for 1 second to switch the alarm on or off.

Setting alarm thresholds — i50 Depth

You can adjust the threshold at which alarms are triggered by following the steps below.

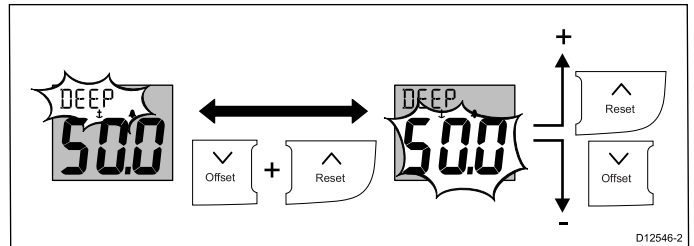

With the relevant alarm page displayed:

1. Press the **Offset** and **Reset** buttons at the same time to change the alarm threshold. The current threshold will start to flash.
2. Use the **Reset** button to increase the alarm threshold.
3. Use the **Offset** button to decrease the alarm threshold.
4. The alarm threshold page will time-out after approximately 6 seconds of inactivity, automatically saving the new alarm threshold.

6.12 Illumination

Adjusting the backlight level — i50 Depth

The backlighting level can be accessed using the Depth button.

During normal operation:

1. Press and hold the **Depth** button for approximately 2 seconds to display the Backlight page.

LAMPS is displayed on-screen and the current backlight level.

2. Use the **Reset** button to increase the backlight setting to the required level.
3. Use the **Offset** button to increase the backlight setting to the required level.

The backlight level can be adjusted from level 1 to level 9 or switched Off (default).

Note: The backlight page will time-out after 8 seconds of inactivity.

Adjusting the contrast — i50 Depth

The contrast level can be accessed using the power button.

During normal operation:

1. Press and hold the **Depth** button for approximately 4 seconds to display the Contrast page.

CONTRAST is displayed on-screen and the current contrast level.

2. Use the **Depth** button to cycle through the available contrast levels.

The contrast level can be adjusted from level 0 (default) to 3.

Note: The contrast page will time-out after 8 seconds of inactivity.

Group illumination

Group illumination is used to synchronizes and control the backlighting level of multiple units assigned to the same group.

The unit can participate in shared illumination via a SeaTalk network or group illumination via a SeaTalk^{ng} network.

When connected on a SeaTalk network all compatible units will share their backlight level (when 1 unit's backlighting level is adjusted all other units backlight level will also change).

When connected on a SeaTalk^{ng} network the unit can participate in group illumination and be assigned to a group of units which will share their backlighting levels. Available groups are as follows:

- OFF (default) — Group illumination is switched off
- HL1 — Helm 1
- HL2 — Helm 2
- CPt — Cockpit

- FLY — Flybridge
- NST — Mast
- GP1 to GP5 — User defined groups

When assigned to a group, when the backlighting of 1 unit is adjusted the backlighting level of all units assigned to the same group will also change.

Assigning the i50 Depth to a group

To assign the i50 Depth as part of a group so that it can participate in group illumination follow the steps below.

During normal operation:

1. Press and hold the **Depth** and **Alarm** buttons at the same time for 6 seconds, until the Group illumination page is displayed.

GROUP CAL is displayed on-screen.

Note: The Group illumination entry page is a temporary page and will time-out to the previous page after 8 seconds.

2. Press the **Depth** button to display the **Groups** page.
3. Press the **Offset** and **Reset** buttons at the same time to enable selection of a group. The group setting will flash.
4. Use the **Reset** button to cycle upwards through the list of available groups.
5. Use the **Offset** button to cycle back down through the list.
6. Press the **Offset** and **Reset** buttons at the same time to assign the display to the selected group. The group setting will stop flashing.
7. Press and hold the **Depth** and **Alarm** buttons at the same time for approximately 2 seconds to return to normal operation.

Chapter 7: i50 Speed

Chapter contents

- 7.1 i50 Speed operation on page 44
- 7.2 i50 Speed controls on page 44
- 7.3 Power on page 45
- 7.4 Data master on page 45
- 7.5 Calibration on page 46
- 7.6 User Calibration - i50 Speed on page 46
- 7.7 Intermediate calibration — i50 Speed on page 49
- 7.8 Dealer calibration — i50 Speed on page 51
- 7.9 Using the speed pages on page 52
- 7.10 Using the log, trip and temperature pages on page 53
- 7.11 Using the timers on page 53
- 7.12 Illumination on page 54

7.1 i50 Speed operation

When connected to the relevant speed or speed and temperature transducer, your i50 Speed instrument provides:

- Current, maximum and average speed information, in either knots (KTS), mile per hour (MPH) or kilometers per hour (KPH).
- Log and trip information, in either nautical miles (NM), statute miles (M) or kilometers (KM).
- Water temperature information, in either degrees celsius (°C) or fahrenheit (°F).
- Velocity made good (VMG) information, VMG is only available when connected to SeaTalk or SeaTalk^{ng} network which also contains a compatible wind transducer.
- Speed over ground (SOG) information, SOG is only available when connected to SeaTalk or SeaTalk^{ng} network which also contains a suitable GPS.
- Count-up and race start timers

Note: The required speed, distance and temperature units are selected during User calibration.

It should be noted that:

- The maximum speed, average speed and trip reading are reset to zero at power up.
- The log screen shows the total distance covered by the vessel since the unit was fitted.

7.2 i50 Speed controls

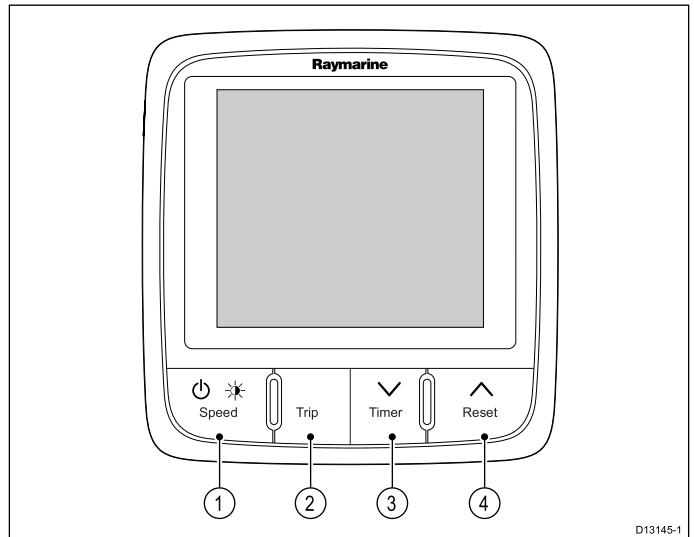

1	Speed / Power — Select to access speed information, adjust backlight, adjust contrast and power the display On and Off
2	Trip — Select to access log, trip and water temperature information
3	Timer / Down — Select to access timers. Use to move down through menu options or to decrease numeric values
4	Reset / Up — Select and hold down for 3 seconds to reset data to current values. Use to move up through menu options or to increase numeric values

7.3 Power

Powering on the unit

With power to the unit turned on but the unit switched off:

1. Press and hold the **Power** button until the unit powers on and data is displayed (approximately 2 seconds).

Note: When power to the unit is turned on the unit will switch on automatically.

Powering off the unit

1. Press and hold the **Power** button until the power count down timer is displayed and reaches zero (approximately 6 to 8 seconds).

7.4 Data master

Where a system contains more than one unit capable of displaying a data type, the unit physically connected to the transducer must be set as the data master and any other units set as a repeater.

Checking i50 Speed software version and status

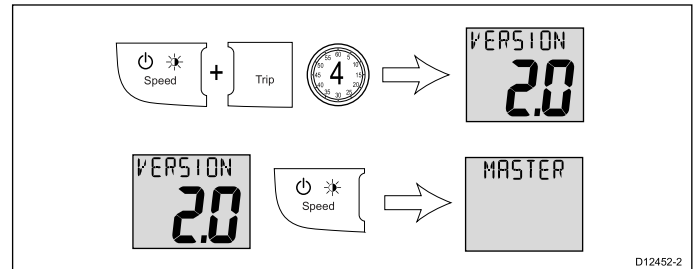

During normal operation:

1. Press and hold the **Speed** and **Trip** buttons at the same time for approximately 4 seconds, until the Software Version page is displayed.
2. Press the **Speed** button to display the instrument status.
Master (transducer connected) or Repeater (No transducer connected).
3. Press the **Speed** button again to begin the Speed Run Calibration.
4. To exit the Intermediate Calibration settings at any time, press and hold the **Speed** and **Trip** buttons at the same time for approximately 4 seconds.

7.5 Calibration

Before first use calibration procedures must be carried out to ensure optimum performance of the instrument with the vessel.

The calibration procedures are:

- User calibration
- Intermediate calibration
- Dealer calibration

7.6 User Calibration - i50 Speed

User calibration options include:

- Units for speed readings — Assigns the unit of measure used for speed related readings.
- Resolution for speed readings — Assigns the layout of speed related readings.
- Units for log readings — Assigns the unit of measure used for log related readings.
- Units for water temperature — Assigns the unit of measure used for temperature related readings.
- * Correct speed reading — Assigns an offset to the speed reading.
- Timer buzzer — Switches the buzzer warning on and off for the timer.

Note: * These settings are only available on displays when the instrument status is set to Master (see Intermediate Calibration for details of changing the display to be Master or Repeater).

Accessing the User Calibration Menu

During normal operation:

1. Press and hold the **Speed** and **Trip** buttons at the same time for approximately 2 seconds, until the **User Calibration** page is displayed.

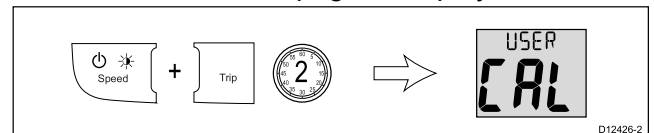

Note: The User Calibration page will time-out after 8 seconds of inactivity.

2. Use the **Speed** button to cycle through the available settings.

Note: To exit the User Calibration pages at any time, press and hold the **Speed** and **Trip** buttons at the same time for approximately 2 seconds.

Selecting the unit of measure for speed readings

From the **User Calibration Menu**:

1. Press the **Speed** button until the **Speed Units** page is displayed (1 press from the **User Calibration** entry page).

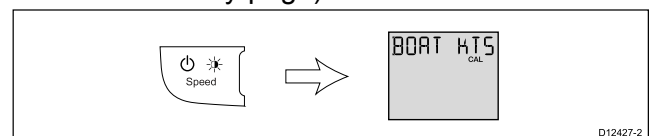

2. Use the **Timer** or **Reset** buttons to select the required unit of measurement for speed readings. The units of measure available for speed readings are:
 - KTS — Knots (default)
 - MPH — Miles Per Hour
 - KMH — Kilometers Per Hour

Note: To exit the User Calibration pages at any time, press and hold the **Speed** and **Trip** buttons at the same time for approximately 2 seconds.

Selecting a speed resolution

From the **User Calibration Menu**:

1. Press the **Speed** button until the **Speed Resolution** page is displayed (2 presses from the **User Calibration** entry page).

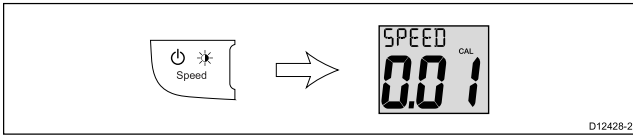

2. Use the **Timer** or **Reset** buttons to select the required resolution for speed readings. The resolutions available are 0.01 (default) and 0.1.

Note: To exit the User Calibration pages at any time, press and hold the **Speed** and **Trip** buttons at the same time for approximately 2 seconds.

Selecting the unit of measure for log readings

From the **User Calibration Menu**:

1. Press the **Speed** button until the **Log Units** page is displayed (3 presses from the **User Calibration** entry page).

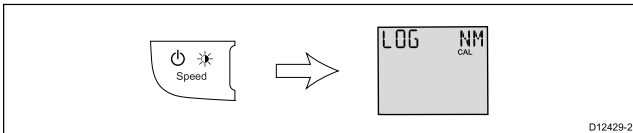

2. Use the **Timer** and **Reset** buttons to select the required unit of measurement for log readings.
 - SM (default) — Statute Miles
 - NM — Nautical Miles
 - KM — Kilometers

Note: To exit the User Calibration pages at any time, press and hold the **Speed** and **Trip** buttons at the same time for approximately 2 seconds.

1 point speed calibration

The instrument display's speed readings can be calibrated using a 1 point calibration process, in most situations this is all that will be required to calibrate our speed readings.

Prerequisites:

- For best results SOG data should be available, or an alternative method of estimating vessel speed must be used (e.g. vessel speed can be estimated using [Nautical Measured Mile Markers](#) or similar landmarks of a known distance apart).
- You will need to be underway, with sufficient space to maneuver unhindered.
- In order to achieve accurate results, water conditions must be calm with zero tide and zero current.

From the **User Calibration Menu**:

1. Steer your vessel on a steady course at a constant typical speed.

2. Press the **Speed** button until 1 of the Current Speed pages is displayed (4 presses from the **User Calibration** entry page).

If SOG data is available over SeaTalk^{ng} then the SOG page is displayed, if SOG data is not available then the Calibration Factor page is displayed.

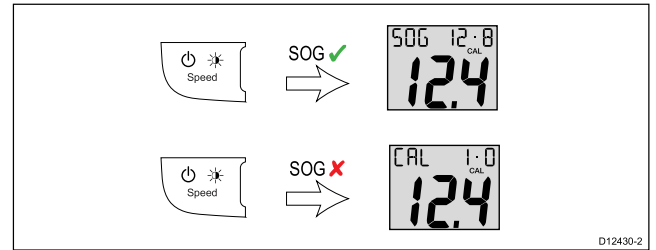

3. If the **SOG** page is displayed and the water conditions are acceptable, press and hold the **Reset** button for approximately 3 seconds to accept SOG as the current log speed.

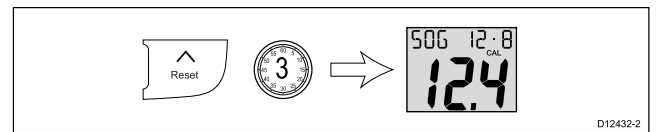

4. Alternatively, with the Calibration Factor page displayed use the **Timer** and **Reset** buttons to adjust the calibration factor until the displayed speed matches your estimated speed. The default calibration factor is 1.00. The calibration factor can be set from 0.25 to 2.50.
5. If SOG is available you can switch between the **Calibration Factor** and **SOG** pages by pressing the **Timer** and **Reset** buttons at the same time.

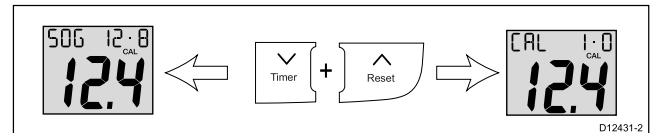

Note: To exit the User Calibration pages at any time, press and hold the **Speed** and **Trip** buttons at the same time for approximately 2 seconds.

Nautical measured mile markers

When neither SOG data or any other reliable means of estimating Speed Through the Water (STW) is available, Nautical Measured Mile Markers can be used to help calibrate Log Speed. Nautical measured mile markers are identified by two pairs of posts or towers. The distance between each pair of markers is 1 nautical mile.

Each marker in a pair is separated by distance and elevation from its partner. The front marker is closer to the water and shorter than the marker behind it.

Markers — side view

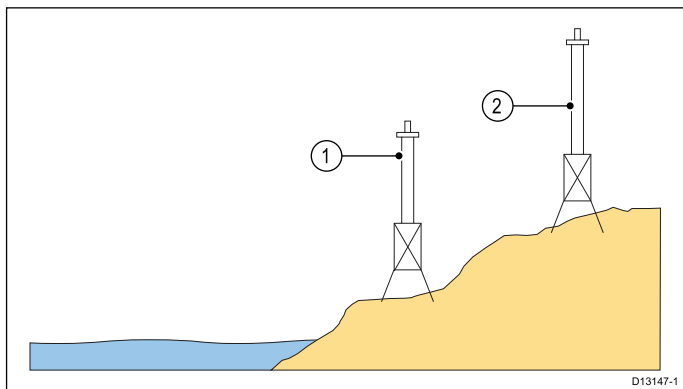

1. Front marker
2. Rear marker

When the 2 markers appear vertically aligned the vessel is on the correct range line to begin a measured mile run.

Marker alignment

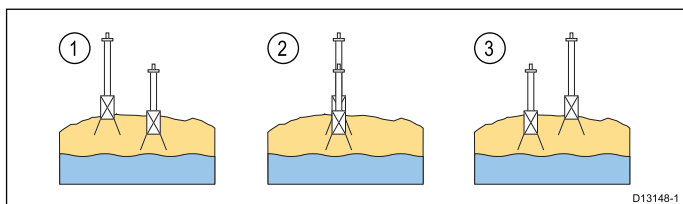

1. Left of range line
2. On range line
3. Right of range line

The vessel should already be at top speed and as the first pair of markers appear aligned a stopwatch should be started, when the vessel passes the second pair of aligned markers the stopwatch is stopped.

Measuring a nautical mile

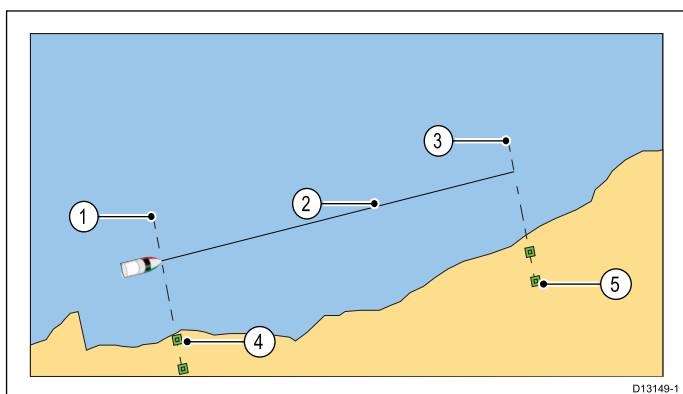

1. Starting point (start stopwatch)
2. Measured mile
3. End point (stop stopwatch)
4. First pair of markers
5. Second pair of markers

To provide a more accurate reading the vessel should make between 4 to 6 runs in both directions to allow for tide and wind conditions. The average of the time taken over all runs should be used to calculate Log Speed.

The vessel speed can then be worked out by taking the distance travelled (1 nautical mile) and dividing it by the average time taken to perform the run. The resulting calculation is your average speed in knots.

Selecting unit of measure for water temperature readings

From the **User Calibration Menu**:

1. Press the **Speed** button until the **Water Temperature Units** page is displayed (5 presses from the **User Calibration** entry page).

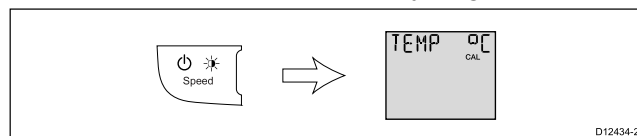

2. Use the **Timer** or **Reset** buttons to select the required unit of measurement for water temperature readings.

The units of measure available for temperature are:

- °C (default) — degrees Celsius
- °F — degrees Fahrenheit

Note: To exit the User Calibration pages at any time, press and hold the **Speed** and **Trip** buttons at the same time for approximately 2 seconds.

Calibrating water temperature

You will need a suitable thermometer to measure the water temperature.

From the **User Calibration Menu**:

1. Press the **Speed** button until the **Water Temperature Calibration** page is displayed (6 presses from the **User Calibration** entry page).

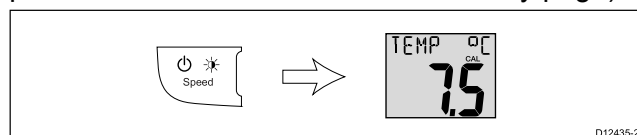

2. Use a suitable thermometer to measure the water temperature.
3. Use the **Timer** and **Reset** buttons to match the displayed water temperature to the water temperature measured by the thermometer.

Note: To exit the User Calibration pages at any time, press and hold the **Speed** and **Trip** buttons at the same time for approximately 2 seconds.

Enabling and disabling timer buzzers

From the **User Calibration Menu**:

1. Press the **Speed** button until the **Timer Buzzer** page is displayed (76 presses from the **User Calibration** entry page).

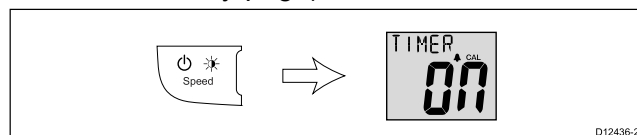

2. Use the **Timer** or **Reset** buttons to switch the timer buzzers On and Off (default).

Note: To exit the User Calibration pages at any time, press and hold the **Speed** and **Trip** buttons at the same time for approximately 2 seconds.

7.7 Intermediate calibration — i50 Speed

Intermediate calibration allows you to:

- Check the instrument software version.
- Check and if necessary set the instrument status as either Master or Repeater.
- Perform a calibration speed run over a measured distance to ensure accurate speed readings.

Checking i50 Speed software version and status

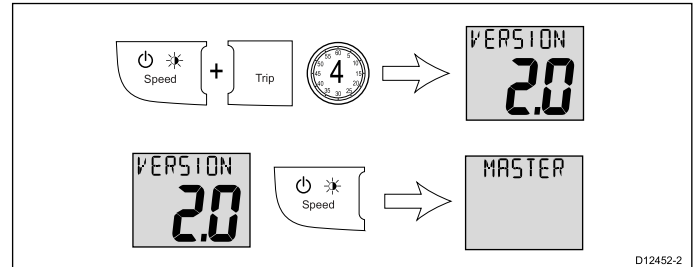

During normal operation:

1. Press and hold the **Speed** and **Trip** buttons at the same time for approximately 4 seconds, until the Software Version page is displayed.
2. Press the **Speed** button to display the instrument status.
Master (transducer connected) or Repeater (No transducer connected).
3. Press the **Speed** button again to begin the Speed Run Calibration.
4. To exit the Intermediate Calibration settings at any time, press and hold the **Speed** and **Trip** buttons at the same time for approximately 4 seconds.

Performing a Speed Run Calibration

The Speed Run Calibration involves carrying out 2 or more runs, over a measured distance, to enable a calibration factor to be determined. Each run consists of an outward and a return leg which minimizes the effect of tidal drift when the calibration factor is determined.

From the Intermediate Calibration page:

Note: This procedure is not required if Speed is set to SOG.

1. Press the **Speed** button until you reach the Speed Run Calibration page (2 presses from the Software Version page).

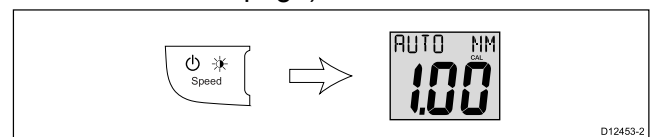

2. Press the **Timer** and **Reset** buttons at the same time.

The run length flashes.

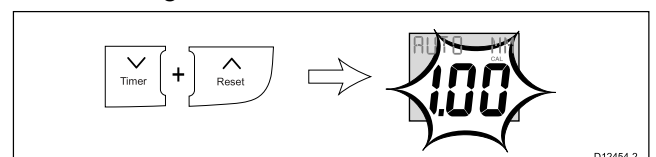

- Use the **Timer** and **Reset** buttons to set the run length to the required value.
Default value is 1.00, the run length can be set to any value between 0.25 and 2.5.

- Press the **Timer** and **Reset** buttons at the same time to commence the Speed Run Calibration. The Calibration Status page is displayed. The text at the top of the page alternates between **START 1** and the Calibration Factor currently applied.

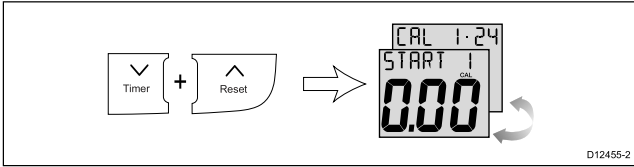

- Start the outward leg of the run and as you pass the start point, press the **Trip** button, so the page shows **OUTWARD** at the top. As the run proceeds, the displayed value will change.

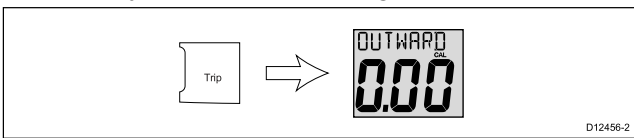

- At the end of the outward leg press **Trip** again.

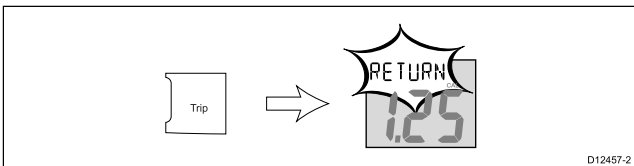

The text **RETURN** will flash at the top of the page and the displayed distance freezes.

Note: At this point the displayed distance may not be the same as the measured distance, due to errors introduced by tidal flow.

- Turn your vessel round, start the return leg and as you do so, press the **Trip** button so **RETURN** stops flashing and the displayed value increments.

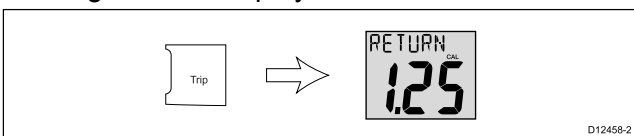

- At the end of the return leg, press the **Trip** button.
At this point:

- The text **START 2** alternating with the new Calibration Factor displayed at the top of the page.
- The displayed distance freezes

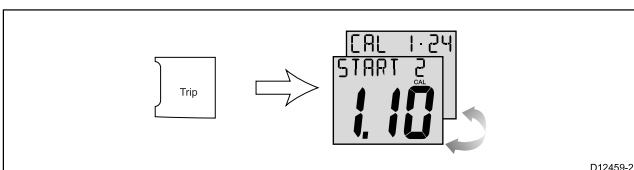

Note: The displayed distance should be very close to the actual (measured) distance of the run.

- If you are satisfied with the results of the first calibration run, press the **Speed** and **Trip** buttons at the same time to save the new Calibration Factor and exit the Speed Run Calibration Menu.

- If you want to carry out a second calibration run, press the **Trip** button.

- Follow steps 5 to 7 above again to complete a second calibration run.

- At the end of the return leg press the **Trip** button
At this point:

- The text **END** alternating with the new Calibration Factor is displayed at the top of the page.
- The displayed distance freezes

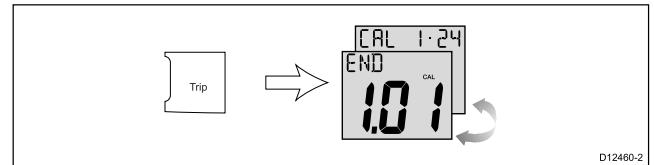

- To exit the Speed Run Calibration at any time, press and hold the **Speed** and **Trip** buttons at the same time for 4 seconds.

7.8 Dealer calibration — i50 Speed

The dealer calibration procedures include:

- User calibration menu access On (default) and Off.
- Display Response for speed readings — Dictates the rate at which the instrument display responds to changes in speed data.
- Display Response for Velocity Made Good (VMG) readings — Dictates the rate at which the instrument display responds to changes in VMG data.
- Boat show mode On and Off (default) (Boat show mode is only available on displays set as repeaters).
- Reset to factory defaults.

Accessing the Dealer Calibration Menu

During normal operation:

1. Press and hold the **Speed** and **Trip** buttons at the same time for approximately 14 seconds, until the **Dealer Calibration** page is displayed.

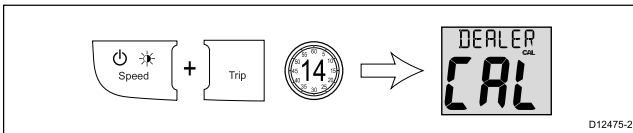

Note: To exit the Dealer Calibration pages at any time, press and hold the **Speed** and **Trip** buttons at the same time for approximately 2 seconds.

Setting access to the User Calibration Menu

From the Dealer Calibration page:

1. Press the **Timer** and **Reset** buttons at the same time to display the **User Calibration Access** page.

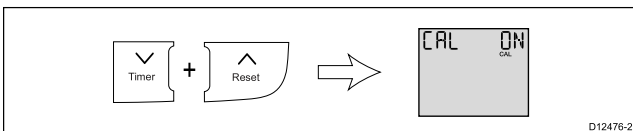

2. Use the **Timer** and **Reset** buttons to switch access to the **User Calibration Menu** On (default) and Off. Selecting Off disables access to the **User Calibration Menu**.

Note: To exit the Dealer Calibration pages at any time, press and hold the **Speed** and **Trip** buttons at the same time for approximately 2 seconds.

Setting the response delay for speed readings

From the **User Calibration Menu Access** page:

1. Press the **Speed** button until the **Speed Response** page is displayed (1 press from **User Calibration Menu Access** page).

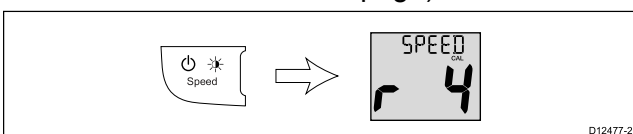

2. Use the **Timer** and **Reset** buttons to adjust the speed response to the required level. The default level is 12. The levels available are 1 to 15 with level 1 being the slowest update rate and level 15 the quickest.

Note: To exit the Dealer Calibration pages at any time, press and hold the **Speed** and **Trip** buttons at the same time for approximately 2 seconds.

Setting the response delay for VMG (wind) readings

From the **User Calibration Menu Access** page:

1. Press the **Speed** button until the **VMG Response** page is displayed (2 presses from **User Calibration Menu Access** page).

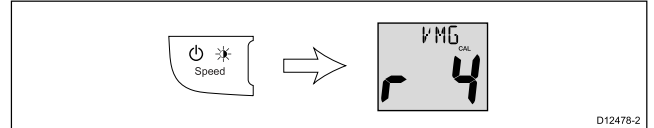

2. Use the **Timer** or **Reset** buttons to adjust the VMG response to the required level. The default level is 12. The levels available are 1 to 15 with level 1 being the slowest update rate and level 15 the quickest.

Note: To exit the Dealer Calibration pages at any time, press and hold the **Speed** and **Trip** buttons at the same time for approximately 2 seconds.

Enabling and disabling Boat Show Mode

From the **User Calibration Menu Access** page:

1. Press the **Speed** button until the **Boat Show Mode** page is displayed (3 presses from **User Calibration Menu Access** page).

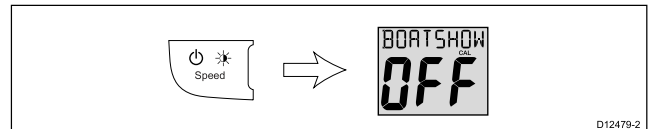

2. Use the **Timer** and **Reset** buttons to switch boat show mode On and Off (default). Selecting On will put the display into boat show mode.

Note: Boat show mode is only suitable for demonstration purposes and should NOT be used whilst your vessel is in use.

Note: To exit the Dealer Calibration pages at any time, press and hold the **Speed** and **Trip** buttons at the same time for approximately 2 seconds.

Resetting the display to factory defaults

From the **User Calibration Menu Access** page:

1. Press the **Speed** button until the **Factory Defaults** page is displayed (4 presses from **User Calibration Menu Access** page).

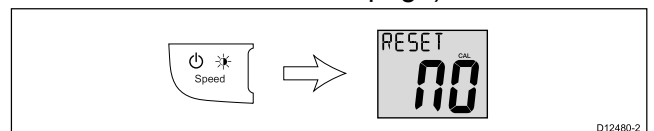

2. To reset the display to factory default settings:

- i. Use the **Timer** or **Reset** buttons to change the reset option to Yes.
 - ii. Press the **Speed** button to reset your display to factory default settings.
3. After a reset it is recommended that you check the data master status of the display to ensure it is set correctly. Refer to [7.4 Data master](#) for details.

Note: To exit the Dealer Calibration pages at any time, press and hold the **Speed** and **Trip** buttons at the same time for approximately 2 seconds.

7.9 Using the speed pages

To cycle through the speed pages follow the steps below:

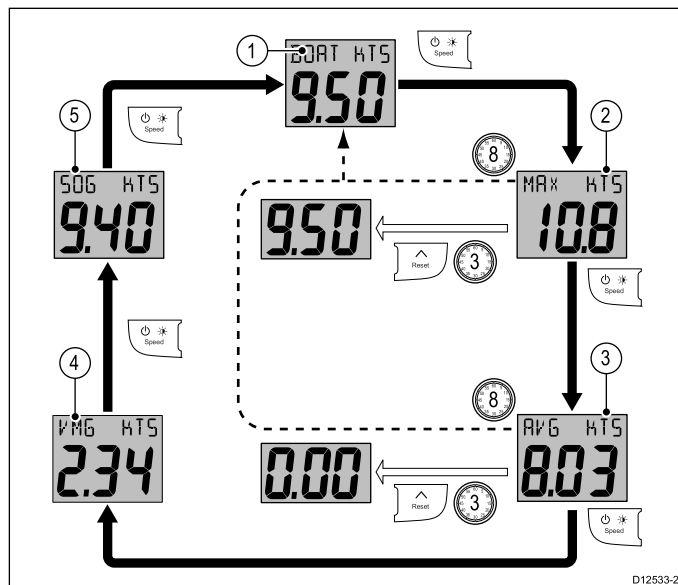

1. Current Speed page
2. [1] Maximum Speed page
3. [1] Average Speed page
4. [2] VMG (wind) page
5. [3] SOG page

Note:

- [1] These pages are temporary pages and will revert back to the previous permanent page after 8 seconds of inactivity.
- [2] The VMG (wind) information is only available if your unit is part of a SeaTalk or SeaTalk^{ng} network which has a compatible wind instrument and transducer connected.
- [3] SOG information is only available if your unit is part of a SeaTalk or SeaTalk^{ng} network which has a suitable GPS connected.

1. Use the **Speed** button to cycle through the available speed pages.
2. From the Maximum Speed page or Average Speed page, press and hold the **Reset** button for approximately 3 seconds to reset the reading.

7.10 Using the log, trip and temperature pages

To cycle through the available log, trip and water temperature pages follow the steps below.

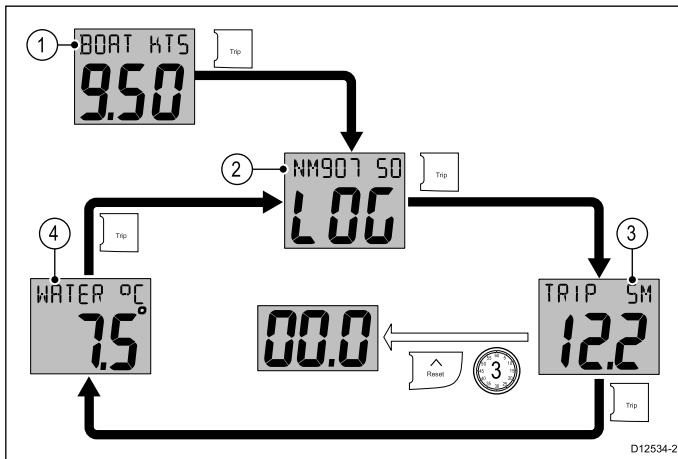

1. Current Speed page
2. Log page
3. Trip page
4. Water temperature page

During normal operation:

1. Use the **Trip** button to cycle through the available pages.
2. From the Trip page, press and hold the **Reset** button for approximately 3 seconds to reset the reading.

7.11 Using the timers

To cycle through and use the Race Timer pages and Stop Watch page follow the steps below.

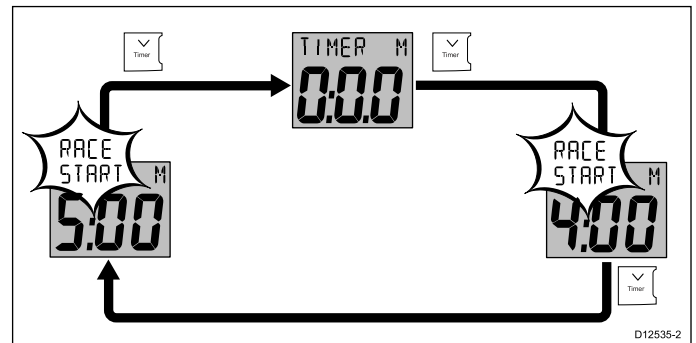

During normal operation:

1. Press the **Timer** button to cycle through the available timers.
2. Press the **Reset** button to start the timer.
3. With the timer running, press the **Reset** button to pause the timer.
4. With the timer running, press and hold the **Reset** button for 1 second to reset the timer.

Note: After the race timers have counted down to zero they will then start to count upwards from zero.

Setting the race start timer

The race start timers can be set from 1 to 15 minutes.

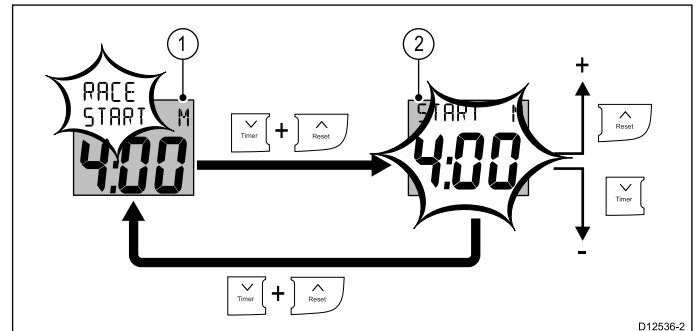

With a **race timer** displayed

1. Press the **Timer** and **Reset** buttons at the same time to adjust the race timer. The set time will flash.
2. To change the race timer:
 - i. Use the **Reset** button to increase the race timer start value, or
 - ii. Use the **Timer** button to decrease the race timer start value.
 - iii. Press the **Timer** and **Reset** buttons at the same time to confirm the new value.

Timer buzzer

The Timer buzzer is enabled or disabled during calibration see the *User calibration* section.

When using a race timer with the timer buzzer enabled, the buzzer will:

- Short double beep every minute.
- 3 Long beeps at the start of the last 30 seconds.
- Short beep once for each of the last 10 seconds.
- Long beep at zero.

7.12 Illumination

Adjusting the backlight level — i50 Speed

The backlighting level can be accessed using the Speed button.

During normal operation:

1. Press and hold the **Speed** button for approximately 2 seconds to display the Backlight page.

LAMPS is displayed on-screen and the current backlight level.

2. Use the **Reset** button to increase the backlight setting to the required level.
3. Use the **Timer** button to increase the backlight setting to the required level.

The backlight level can be adjusted between level 1 to 9 or switched Off (default).

Note: The backlight page will time-out after 8 seconds of inactivity.

Adjusting the contrast — i50 Speed

The contrast level can be accessed using the Speed button.

During normal operation:

1. Press and hold the **Speed** button for approximately 4 seconds to display the Contrast page.

CONTRAST is displayed on-screen and the current contrast level.

2. Use the **Speed** button to cycle through the available contrast levels.

The contrast level can be adjusted from level 0 (default) to 3.

Note: The contrast page will time-out after 8 seconds of inactivity.

Group illumination

Group illumination is used to synchronizes and control the backlighting level of multiple units assigned to the same group.

The unit can participate in shared illumination via a SeaTalk network or group illumination via a SeaTalk^{ng} network.

When connected on a SeaTalk network all compatible units will share their backlight level (when 1 unit's backlighting level is adjusted all other units backlight level will also change).

When connected on a SeaTalk^{ng} network the unit can participate in group illumination and be assigned to a group of units which will share their backlighting levels. Available groups are as follows:

- OFF (default) — Group illumination is switched off
- HL1 — Helm 1
- HL2 — Helm 2
- CPt — Cockpit

- FLY — Flybridge
- NST — Mast
- GP1 to GP5 — User defined groups

When assigned to a group, when the backlighting of 1 unit is adjusted the backlighting level of all units assigned to the same group will also change.

Assigning the i50 Speed to a group

To assign the i50 Speed as part of a group so that it can participate in group illumination follow the steps below.

During normal operation:

1. Press and hold the **Speed** and **Trip** buttons at the same time for 6 seconds, until the Group illumination page is displayed.

GROUP CAL is displayed on-screen.

Note: The Group illumination entry page is a temporary page and will time-out to the previous page after 8 seconds.

2. Press the **Speed** button to display the **Groups** page.
3. Press the **Timer** and **Reset** buttons at the same time to enable selection of a group.
The group setting will flash.
4. Use the **Reset** button to cycle upwards through the list of available groups.
5. Use the **Timer** button to cycle back down through the list.
6. Press the **Timer** and **Reset** buttons at the same time to assign the display to the selected group.
The group setting will stop flashing.
7. Press and hold the **Speed** and **Trip** buttons at the same time for approximately 2 seconds to return to normal operation.

Chapter 8: i50 Tridata

Chapter contents

- 8.1 i50 Tridata operation on page 56
- 8.2 i50 Tridata controls on page 56
- 8.3 Power on page 57
- 8.4 Data master on page 57
- 8.5 Calibration on page 58
- 8.6 User Calibration - i50 Tridata on page 58
- 8.7 Intermediate calibration — i50 Tridata on page 62
- 8.8 Dealer calibration — i50 Tridata on page 63
- 8.9 Using Tridata depth pages on page 65
- 8.10 Using Tridata speed pages. on page 65
- 8.11 Using Tridata trip, log, temp and timer pages on page 66
- 8.12 Using the timers on page 66
- 8.13 Alarms on page 67
- 8.14 Illumination on page 68

8.1 i50 Tridata operation

When connected to the relevant transducer(s) your i50 Tridata instrument:

- Provides depth information in either feet (FT) or metres (M).
- Enables you to define alarm thresholds for shallow alarm, deep alarm, shallow anchor alarm and deep anchor alarm.
- Provides speed information (current, maximum and average), in either knots (KTS), miles per hour (MPH) or kilometers per hour (KPH).
- Velocity made good (VMG) information, VMG is only available when connected to SeaTalk or SeaTalk^{ng} network which also contains a compatible wind transducer.
- Provides log and trip information. These are given in either nautical miles (NM), statute miles (M) or kilometers (KM).
- Provides water temperature information. This is given in either degrees celsius (°C) or degrees fahrenheit (°F).
- Provides count up and race start timer functions.

Note: Depth information is obtained from the depth transducer connected to the unit. However, when the instrument is connected to a SeaTalk network, which contains a compatible sonar module (fishfinder) the depth information is provided by the sonar module whilst it is switched on.

It should be noted that:

- The required units of measurement are set during User calibration.
- Up / Down depth-trend arrows are displayed, if the seabed is rising or falling at a significant rate.
- The log screen shows the total distance covered by the vessel since the unit was fitted.
- Maximum speed, average speed and trip reading are reset to zero at power up.
- If for any reason depth information is lost, the depth title will flash and the displayed value will be the last known depth reading.

i50 Tridata display layout

The i50 Tridata display is divided into 3 separate areas, each of which displays a separate type of information, as shown below.

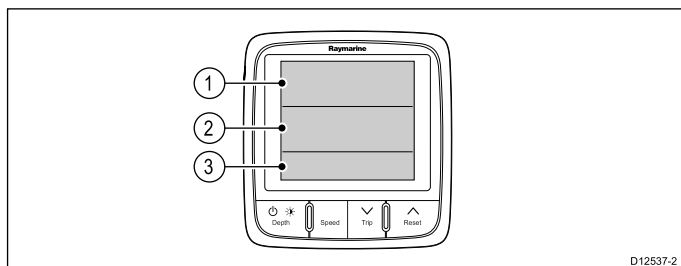

1	Depth information
2	Speed information
3	Trip, log, water temperature and timer

8.2 i50 Tridata controls

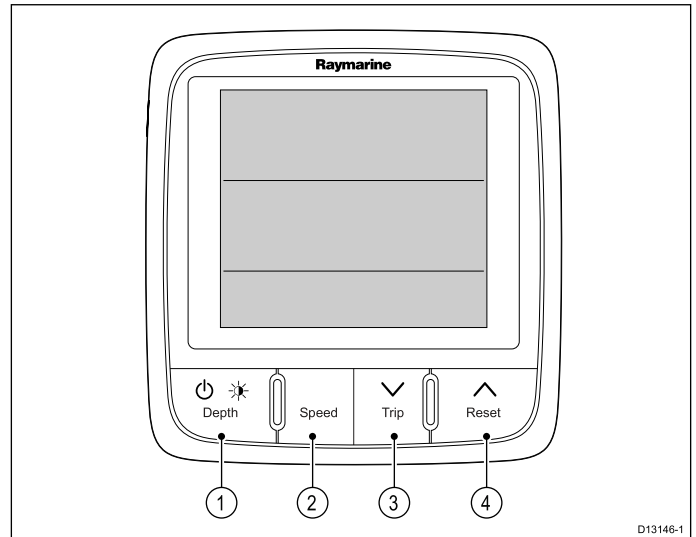

1	Depth / Power — Select to access Depth information, adjust backlight, adjust contrast and power the display On and Off
2	Speed — Select to access Speed and VMG information
3	Trip / Down — Select to access log, trip and water temperature information. Use to move down through menu options or to decrease numeric values
4	Reset / Up — Select and hold down for 3 seconds to reset data to current values. Use to move up through menu options or to increase numeric values

8.3 Power

Powering on the unit

With power to the unit turned on but the unit switched off:

1. Press and hold the **Power** button until the unit powers on and data is displayed (approximately 2 seconds).

Note: When power to the unit is turned on the unit will switch on automatically.

Powering off the unit

1. Press and hold the **Power** button until the power count down timer is displayed and reaches zero (approximately 6 to 8 seconds).

8.4 Data master

Where a system contains more than one unit capable of displaying a data type, the unit physically connected to the transducer must be set as the data master and any other units set as a repeater.

Checking i50 Tridata software version and status

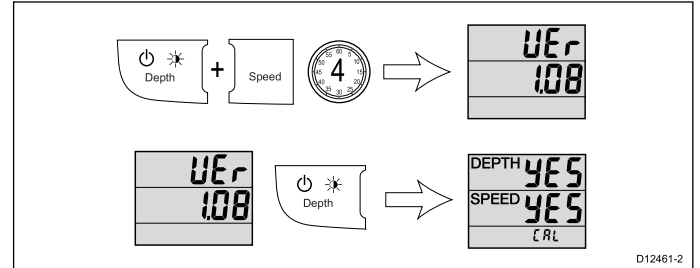

During normal operation:

1. Press and hold the **Depth** and **Speed** buttons at the same time for approximately 4 seconds, until the Software Version page is displayed.
2. Press the **Depth** button to display the instrument status.
Master (transducer connected) or Repeater (No transducer connected).
3. To change the depth status:
 - i. Press the **Trip** and **Reset** buttons at the same time.
The status will flash.
 - ii. Use the **Trip** or **Reset** button to switch the status between Master or Repeater.
 - i. Press the **Trip** and **Reset** buttons at the same time to confirm the new instrument status.
4. Press the **Depth** button again to begin speed run calibration.
5. To exit the Intermediate calibration settings at any time, press and hold the **Depth** and **Speed** buttons at the same time for approximately 4 seconds:

8.5 Calibration

Before first use calibration procedures must be carried out to ensure optimum performance of the instrument with the vessel.

The calibration procedures are:

- User calibration
- Intermediate calibration
- Dealer calibration

8.6 User Calibration - i50 Tridata

User calibration options include:

- Units for depth readings — Assigns the unit of measure used for depth related readings.
- * Depth offset — Assigns an offset to the depth reading.
- Units for speed readings — Assigns the unit of measure used for speed related readings.
- Resolution for speed readings — Assigns the layout of speed related readings.
- Units for log readings — Assigns the unit of measure used for log related readings.
- Units for water temperature — Assigns the unit of measure used for temperature related readings.
- * Correct speed reading — Assigns an offset to the speed reading.
- Timer buzzer — Switches the buzzer warning on and off for the timer.

Note: * These settings are only available on displays when the instrument status is set to Master (see Intermediate Calibration for details of changing the display to be Master or Repeater).

Accessing the User Calibration Menu

During normal operation:

1. Press and hold down the **Depth** and **Speed** buttons at the same time for approximately 2 seconds, until the **User Calibration** page is displayed.

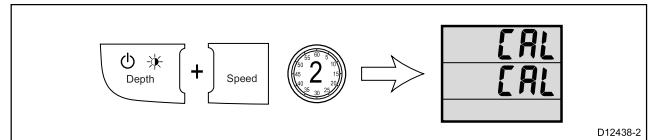

Note: The User Calibration page will time-out after 8 seconds of inactivity.

Selecting the unit of measure for depth readings

From the **User Calibration Menu**:

1. Press the **Depth** button until the **Depth Units** page is displayed (1 press from the **User Calibration** page).

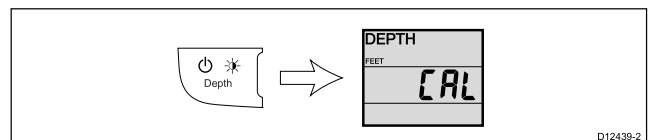

2. Use the **Trip** and **Reset** buttons to select the required units of measurement for depth readings.

The units of measure available for depth readings are:

- FEET (default)
- METRES

Note: To exit the User Calibration pages at any time, press and hold the **Depth** and **Speed** buttons at the same time for approximately 2 seconds to return to normal operation.

Depth Offset

Depths are measured from the transducer to the sea bed, but you can apply an offset value to the depth data, so that the displayed depth reading represents the depth to the sea bed from either the keel or the waterline.

Before attempting to set a waterline or keel offset, find out the vertical separation between the transducer and either the waterline or the bottom of the keel on your vessel, as appropriate. Then set the appropriate depth offset value.

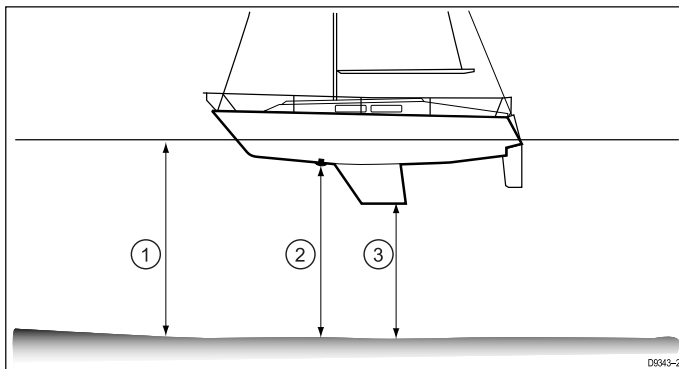

1	Waterline offset
2	Transducer / Zero offset
3	Keel offset

If an offset is not applied, displayed depth readings represent the distance from the transducer to the sea bed.

Applying a Depth Offset

From the **User Calibration Menu**:

1. Press the **Depth** button until the **Depth Offset** page is displayed (2 presses from the **User Calibration** page).

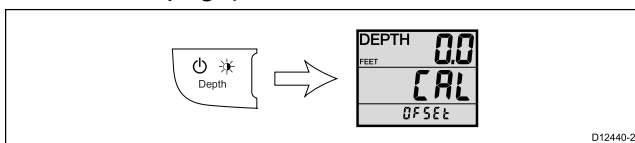

2. Use the **Trip** and **Reset** buttons to select the required depth offset value.

The depth offset can be set to the following values:

- Keel — values between -9.9 to -0.1
- OFFSET (default) (Zero Offset) — 0.0
- W/L (Waterline) — values between 0.1 to 9.9

Note: To exit the User Calibration pages at any time, press and hold the **Depth** and **Speed** buttons at the same time for approximately 2 seconds to return to normal operation.

Selecting the unit of measure for speed readings - i50 Tridata

From the **User Calibration Menu**.

1. Press the **Speed** button until the **Speed Units** page is displayed (1 press from the **User Calibration** page)

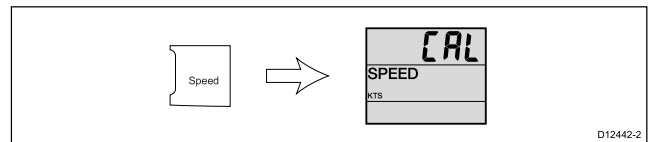

2. Use the **Trip** and **Reset** buttons to select the required unit of measurement for speed readings. The units of measure available for speed readings are:

- KTS — Knots (default)
- MPH — Miles Per Hour
- KMH — Kilometers Per Hour

Note: To exit the User Calibration pages at any time, press and hold the **Depth** and **Speed** buttons at the same time for approximately 2 seconds to return to normal operation.

Selecting a speed resolution

From the **User Calibration Menu**.

1. Press the **Speed** button until the **Speed Resolution** page is displayed (2 presses from the **User Calibration** page).

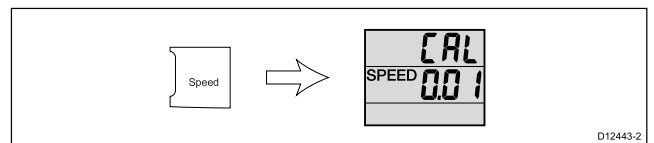

2. Use the **Trip** and **Reset** buttons to select the required resolution for speed readings. The resolutions available are 0.01 (default) and 0.1.

Note: To exit the User Calibration pages at any time, press and hold the **Depth** and **Speed** buttons at the same time for approximately 2 seconds to return to normal operation.

Selecting the unit of measure for log readings

From the **User Calibration Menu**.

1. Press the **Speed** button until the **Log Units** page is displayed (3 presses from the **User Calibration** page).

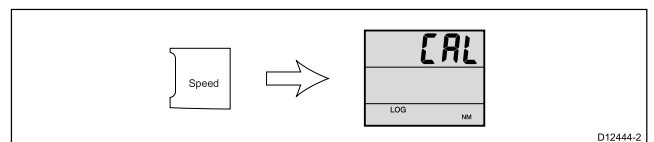

2. Use the **Trip** and **Reset** buttons to select the required unit of measurement for log readings.

- KM (default) — Kilometers
- SM — Statute Miles
- NM — Nautical Miles

Note: To exit the User Calibration pages at any time, press and hold the **Depth** and **Speed** buttons at the same time for approximately 2 seconds to return to normal operation.

1 point speed calibration

The instrument display's speed readings can be calibrated using a 1 point calibration process, in most situations this is all that will be required to calibrate our speed readings.

Prerequisites:

- For best results SOG data should be available, or an alternative method of estimating vessel speed must be used (e.g. vessel speed can be estimated using [Nautical Measured Mile Markers](#) or similar landmarks of a known distance apart).
- You will need to be underway, with sufficient space to maneuver unhindered.
- In order to achieve accurate results, water conditions must be calm with zero tide and zero current.

From the **User Calibration Menu**:

1. Steer your vessel on a steady course at a constant typical speed.
2. Press the **Speed** button until 1 of the Current Speed pages is displayed (4 presses from the **User Calibration** entry page).

If SOG data is available over SeaTalk^{ng} then the SOG page is displayed, if SOG data is not available then the Calibration Factor page is displayed.

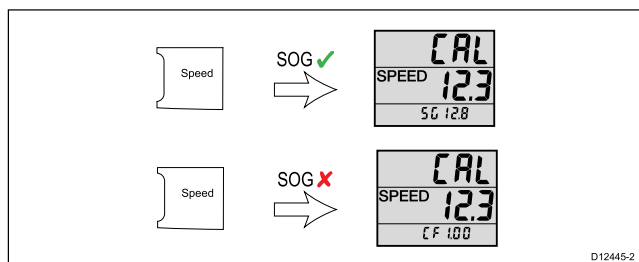

3. If the **SOG** page is displayed and the water conditions are acceptable, press and hold the **Reset** button for approximately 3 seconds to accept SOG as the current log speed.

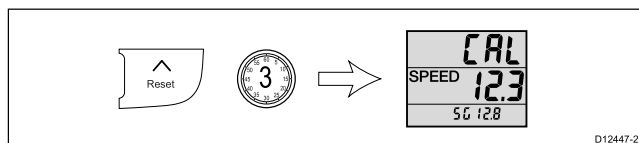

4. Alternatively, with the Calibration Factor page displayed use the **Trip** and **Reset** buttons to adjust the calibration factor until the displayed speed matches your estimated speed.
The default calibration factor is 1.00. The calibration factor can be set from 0.25 to 2.50.
5. If SOG is available you can switch between the **Calibration Factor** and **SOG** pages by pressing the **Trip** and **Reset** buttons at the same time.

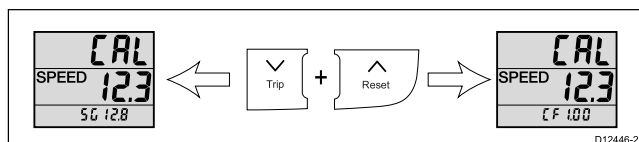

Note: To exit the User Calibration pages at any time, press and hold the **Depth** and **Speed** buttons at the same time for approximately 2 seconds.

Nautical measured mile markers

When neither SOG data or any other reliable means of estimating Speed Through the Water (STW) is available, Nautical Measured Mile Markers can be used to help calibrate Log Speed. Nautical measured mile markers are identified by two pairs of posts or towers. The distance between each pair of markers is 1 nautical mile.

Each marker in a pair is separated by distance and elevation from its partner. The front marker is closer to the water and shorter than the marker behind it.

Markers — side view

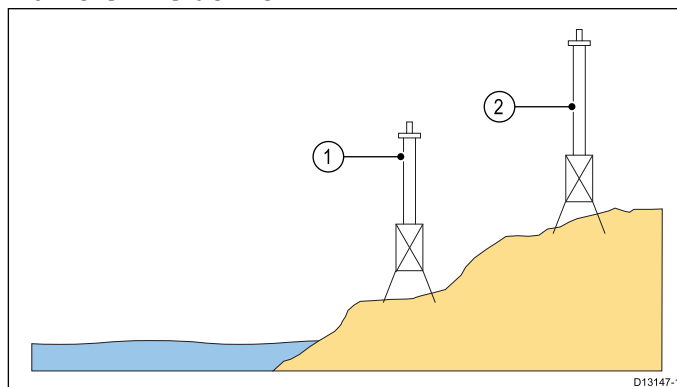

1. Front marker
2. Rear marker

When the 2 markers appear vertically aligned the vessel is on the correct range line to begin a measured mile run.

Marker alignment

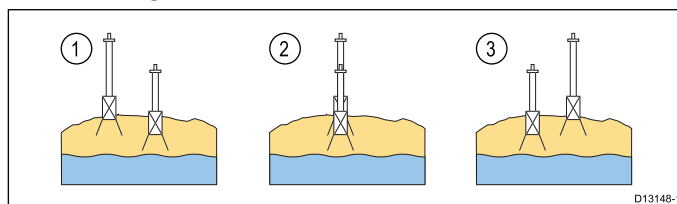

1. Left of range line
2. On range line
3. Right of range line

The vessel should already be at top speed and as the first pair of markers appear aligned a stopwatch should be started, when the vessel passes the second pair of aligned markers the stopwatch is stopped.

Measuring a nautical mile

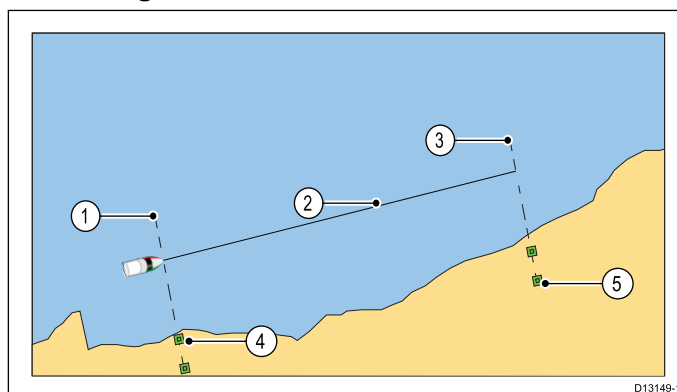

1. Starting point (start stopwatch)
2. Measured mile

3. End point (stop stopwatch)
4. First pair of markers
5. Second pair of markers

To provide a more accurate reading the vessel should make between 4 to 6 runs in both directions to allow for tide and wind conditions. The average of the time taken over all runs should be used to calculate Log Speed.

The vessel speed can then be worked out by taking the distance travelled (1 nautical mile) and dividing it by the average time taken to perform the run . The resulting calculation is your average speed in knots.

Selecting unit of measure for water temperature readings

From the **User Calibration Menu**:

1. Press the **Speed** button until the **Water Temperature Units** page is displayed (5 presses from the **User Calibration** entry page).

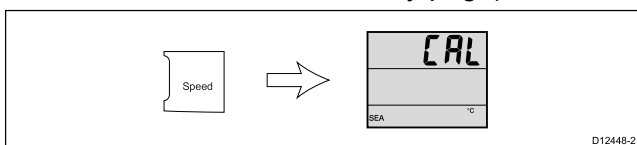

2. Use the **Trip** and **Reset** buttons to select the required unit of measurement for water temperature readings.

The units of measure available for temperature are:

- °C (default) — degrees Celsius
- °F — degrees Fahrenheit

Note: To exit the User Calibration pages at any time, press and hold the **Depth** and **Speed** buttons at the same time for approximately 2 seconds.

Calibrating water temperature

You will need a suitable thermometer to measure the water temperature.

From the **User Calibration Menu**:

1. Press the **Speed** button until the **Water Temperature Calibration** page is displayed (6 presses from the **User Calibration** entry page).

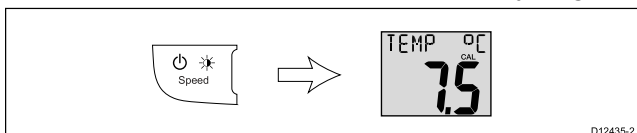

2. Use a suitable thermometer to measure the water temperature.
3. Use the **Trip** and **Reset** buttons to match the displayed water temperature to the water temperature measured by the thermometer.

Note: To exit the User Calibration pages at any time, press and hold the **Depth** and **Speed** buttons at the same time for approximately 2 seconds.

Enabling and disabling timer buzzers

From the **User Calibration Menu**:

1. Press the **Speed** button until the **Timer Buzzer** page is displayed (7 presses from the **User Calibration** entry page).

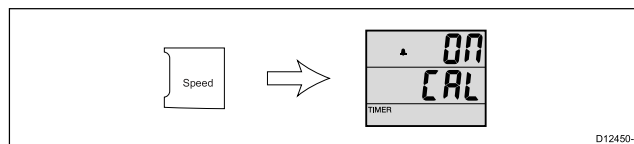

2. Use the **Trip** and **Reset** buttons to switch the timer buzzers On and Off (default).

Note: To exit the User Calibration pages at any time, press and hold the **Depth** and **Speed** buttons at the same time for approximately 2 seconds.

8.7 Intermediate calibration — i50 Tridata

Intermediate calibration allows you to:

- Check the instrument software version.
- Check and if necessary set the instrument status as either Master or Repeater.
- Perform a calibration speed run over a measured distance to ensure accurate speed readings.

Checking i50 Tridata software version and status

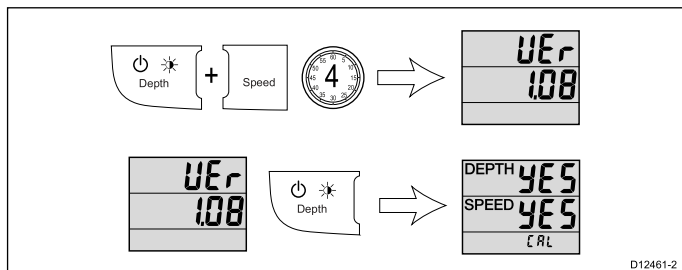

During normal operation:

1. Press and hold the **Depth** and **Speed** buttons at the same time for approximately 4 seconds, until the Software Version page is displayed.
2. Press the **Depth** button to display the instrument status.
Master (transducer connected) or Repeater (No transducer connected).
3. To change the depth status:
 - i. Press the **Trip** and **Reset** buttons at the same time.
The status will flash.
 - ii. Use the **Trip** or **Reset** button to switch the status between Master or Repeater.
 - i. Press the **Trip** and **Reset** buttons at the same time to confirm the new instrument status.
4. Press the **Depth** button again to begin speed run calibration.
5. To exit the Intermediate calibration settings at any time, press and hold the **Depth** and **Speed** buttons at the same time for approximately 4 seconds:

Performing Speed Run Calibration

The Speed Run Calibration involves carrying out 2 or more runs, over a measured distance, to enable a calibration factor to be determined. Each run consists of an outward and a return leg which minimizes the effect of tidal drift when the calibration factor is determined.

Note: This procedure is not required if current speed is set to SOG.

From the Intermediate Calibration page:

1. Press the **Depth** button until you reach the **Calibration Run** page (2 presses from the Software Version page).

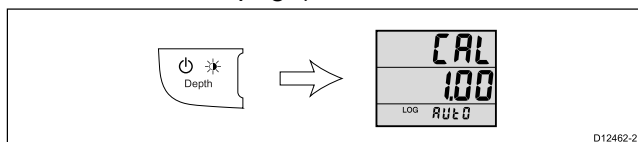

2. Press the **Trip** and **Reset** buttons at the same time.

The run length will flash.

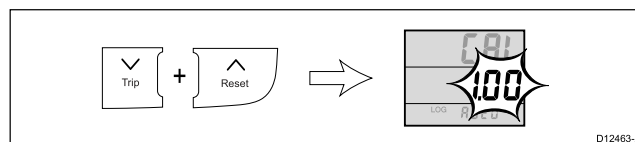

3. Use the **Trip** and **Reset** buttons to adjust the run length to the required value.
The default value is 1.00 (default) the setting can be adjusted from 0.25 to 2.50).

4. Press the **Trip** and **Reset** buttons at the same time to commence the Speed Run Calibration
The text in the bottom section of the screen alternates between **Start 1** and the current Calibration Factor.

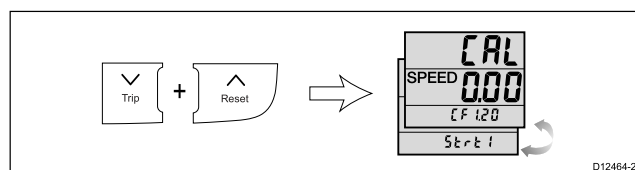

5. Start the outward leg of the calibration run and as you pass the start point, press the **Speed** button, so the page shows **OUT** at the bottom of the screen.

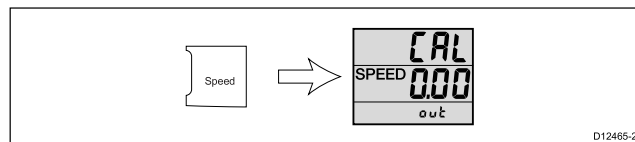

As the calibration run proceeds, the displayed value will change.

6. At the end of the outward leg press the **Speed** button again.

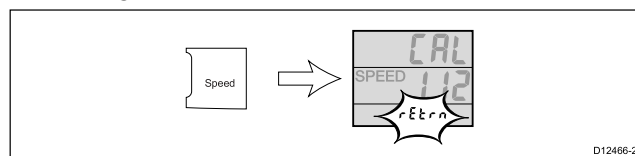

The text **rEtrn** will flash at the bottom of the screen and the displayed distance freezes.

Note: At this point the displayed distance may not be the same as the measured distance, due to errors introduced by tidal flow.

7. Turn your vessel round, start the return leg and as you do so, press the **Speed** button so **rEtrn** stops flashing and the displayed value increments.

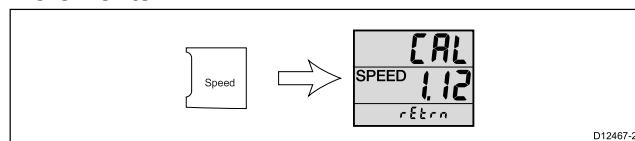

8. At the end of the return leg, press the **Speed** button.

At this point:

- The text **START 2** alternating with the new Calibration Factor is displayed at the top of the page.
- The displayed distance freezes

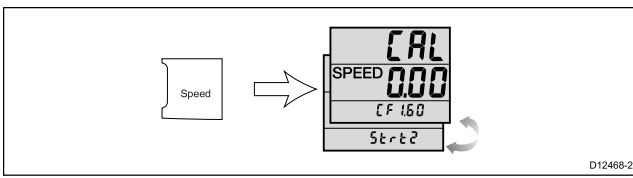

D12468-2

Note: The displayed distance should be very close to the actual (measured) distance of the run.

9. If you are satisfied with the results of the first calibration run, press the **Depth** and **Speed** buttons at the same time for approximately 2 seconds to save the new Calibration Factor, exit speed calibration and return to normal operation.
10. If you want to carry out a second run, press the **Speed** button.
11. Follow steps 5 to 7 above again to complete a second calibration run.
12. At the end of the return leg press the **Speed** button

At this point:

- The text **END** alternating with the new Calibration Factor is displayed at the top of the page.
- The displayed distance freezes.

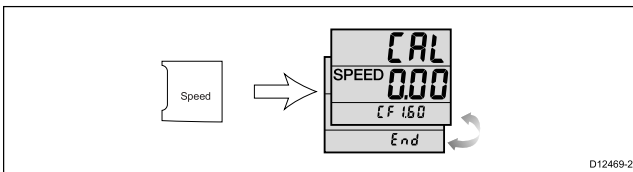

D12469-2

13. To exit the Speed Run Calibration run at any time, press and hold the **Depth** and **Speed** buttons at the same time for approximately 4 seconds.

8.8 Dealer calibration — i50 Tridata

The dealer calibration procedures include:

- User calibration menu access On (default) and Off.
- Data source for speed — The data source can be set to SOG if the display is connected to a network containing a GPS receiver.
- Display Response for speed readings — Dictates the rate at which the instrument display responds to changes in speed data.
- Display Response for Depth readings — Dictates the rate at which the instrument display responds to changes in depth data.
- Boat show mode On and Off (default) (Boat show mode is only available on displays set as repeaters).
- Reset to factory defaults.

Accessing the Dealer Calibration Menu

Follow the steps below to access the Dealer Calibration Menu.

During normal operation:

1. Press and hold the **Depth** and **Speed** buttons at the same time for approximately 14 seconds, until the Dealer Calibration page is displayed.

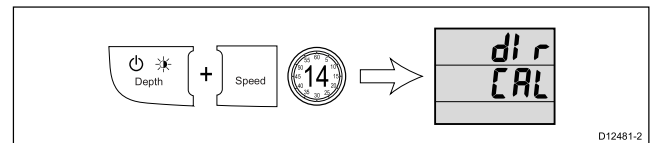

D12481-2

Setting access to the User Calibration Menu

From the Dealer Calibration page:

1. Press the **Trip** and **Reset** buttons at the same time to display the **User Calibration Access** page.

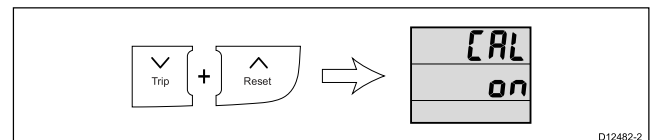

D12482-2

2. Use the **Trip** and **Reset** buttons to switch access to the **User Calibration Menu** On (default) and Off.

Selecting Off disables access to the **User Calibration Menu**.

Note: To exit the Dealer Calibration pages at any time, press and hold the **Depth** and **Speed** buttons at the same time for approximately 2 seconds.

Setting speed to SOG

Your instrument can be setup to use SOG data, if available as the source for speed data instead of a speed transducer.

With the speed source set to SOG the instrument display will ignore speed readings from the connected transducer and only display SOG readings from a connected GPS or GNSS receiver.

From the **User Calibration Menu Access** page:

1. Press the **Depth** button until the Speed Source page is displayed (1 press from the **User Calibration Access Menu** page).

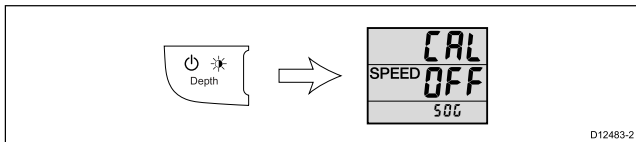

2. Use the **Trip** or **Reset** buttons to switch the speed data source On and Off (default).
Selecting On will display SOG reading instead of speed transducer readings.

Setting the response delay for speed readings

From the **User Calibration Menu Access** page:

1. Press the **Depth** button until the **Speed Response** page is displayed (1 press from **User Calibration Menu Access** page).

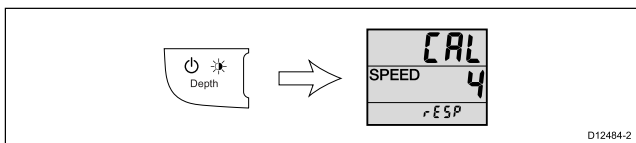

2. Use the **Trip** and **Reset** buttons to adjust the speed response to the required level.
The default level is 12. The levels available are 1 to 15 with level 1 being the slowest update rate and level 15 the quickest.

Note: To exit the Dealer Calibration pages at any time, press and hold the **Depth** and **Speed** buttons at the same time for approximately 2 seconds.

Setting the response delay for depth readings

From the **User Calibration Menu Access** page:

1. Press the **Depth** button until the **Depth Response** page is displayed (3 presses from the **User Calibration Menu Access** page).

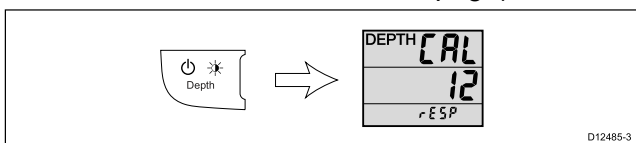

2. Use the **Trip** and **Reset** buttons to adjust the depth response to the required level.
The default level is 12. The levels available are 1 to 15 with level 1 being the slowest update rate and level 15 the quickest.

Note: To exit the Dealer Calibration pages at any time, press and hold the **Depth** and **Speed** buttons at the same time for approximately 2 seconds.

Enabling and disabling Boat Show Mode

From the **User Calibration Menu Access** page:

1. Press the **Depth** button until the **Boat Show Mode** page is displayed (4 presses from **User Calibration Menu Access** page).

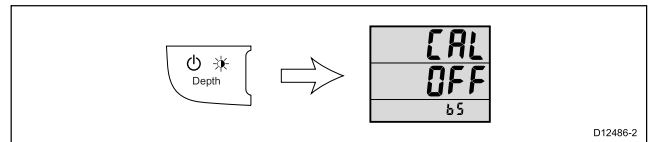

2. Use the **Trip** or **Reset** buttons to switch boat show mode On and Off (default).
Selecting On will put the display into boat show mode.

Note: Boat show mode is only suitable for demonstration purposes and should NOT be used whilst your vessel is in use.

Note: To exit the Dealer Calibration pages at any time, press and hold the **Depth** and **Speed** buttons at the same time for approximately 2 seconds.

Resetting the display to factory defaults

From the **User Calibration Menu Access** page:

1. Press the **Depth** button until the **Factory Defaults** page is displayed (5 presses from **User Calibration Menu Access** page).

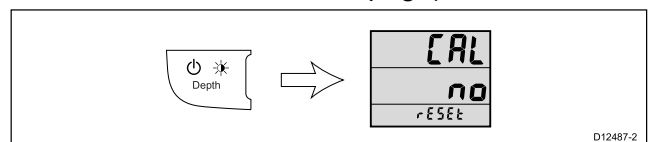

2. To reset the display to factory default settings:
 - i. Use the **Trip** or **Reset** buttons to change the reset option to Yes.
 - ii. Press the **Depth** button to reset your display to factory default settings.
3. After a reset it is recommended that you check the data master status of the display to ensure it is set correctly. Refer to [8.4 Data master](#) for details.

Note: To exit the Dealer Calibration pages at any time, press and hold the **Depth** and **Speed** buttons at the same time for approximately 2 seconds.

8.9 Using Tridata depth pages

To cycle through the depth pages follow the steps below.

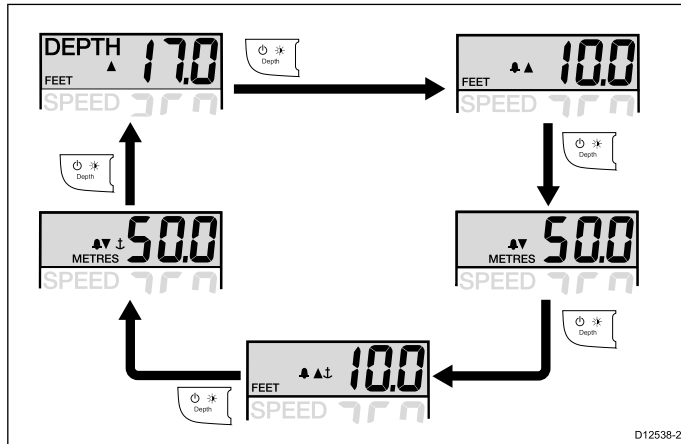

1. Use the **Depth** button to cycle through the available depth pages.

Available depth pages are:

- Current depth
- Shallow depth alarm
- Deep depth alarm
- Shallow anchor alarm
- Deep anchor alarm

Note: Alarm pages are temporary pages will time-out after 8 seconds and revert to the **Current depth** page.

To enable / disable alarms or to adjust alarm thresholds please refer to the *Alarms* section.

8.10 Using Tridata speed pages.

To cycle through the speed pages follow the steps below.

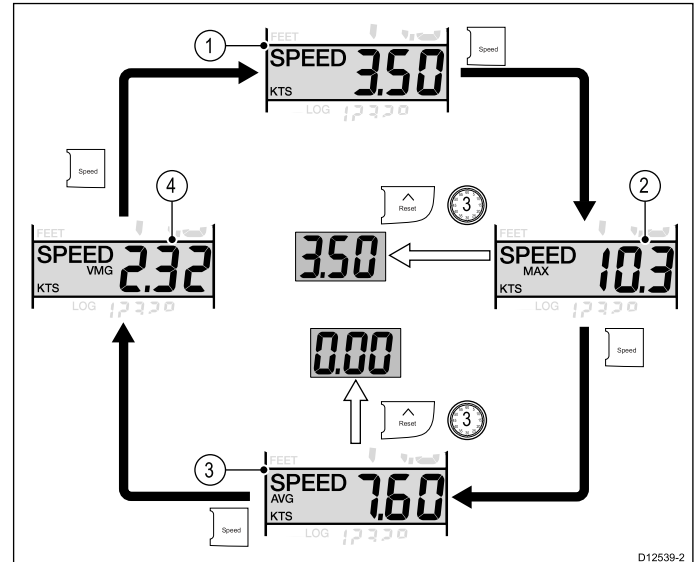

1. Current Speed page
2. [1] Maximum Speed page
3. [1] Average Speed page
4. [2] VMG page

Note:

- [1] These pages are temporary pages and will revert back to the previous permanent page after 8 seconds of inactivity.
- [2] The VMG information is only available if your unit is part of a SeaTalk or SeaTalk^{ng} network which has a compatible wind instrument and transducer connected.

1. Use the **Speed** button to cycle through the available speed pages.
2. From the Maximum Speed page or Average Speed page, press and hold the **Reset** button for approximately 3 seconds to reset the reading.

8.11 Using Tridata trip, log, temp and timer pages

To cycle through the trip, log, water temperature and timer pages follow the steps below.

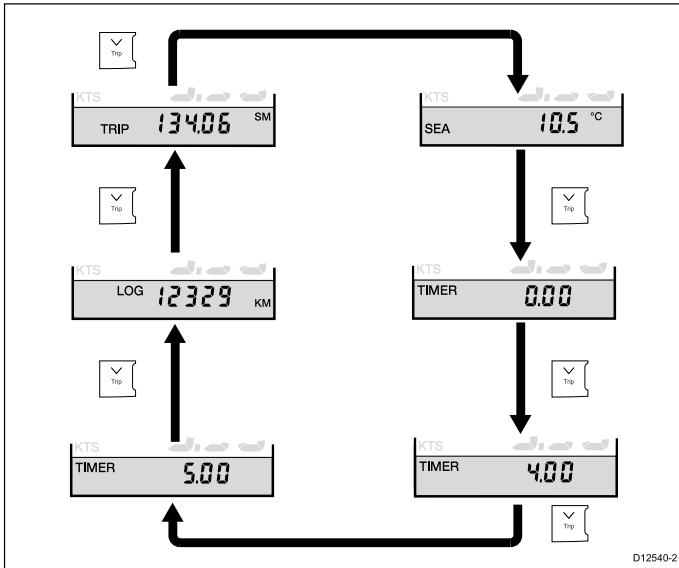

1. Press the **Trip** button to cycle through the **Trip**, **Log**, **Water temperature** and **Timer** pages.

8.12 Using the timers

To cycle through and use the Race Timer pages and Stop Watch page follow the steps below.

With a timer page displayed:

1. Press the **Reset** button to start the timer.
2. With the timer running, press the **Reset** button to pause the timer.
3. With the timer running, press and hold the **Reset** button for approximately 1 second to reset the timer.

Note: After the race timers have counted down to zero they will then start to count upwards from zero.

Setting the race timer

There are 2 race (count-down) timers. The race timers can be set from 1 to 15 minutes.

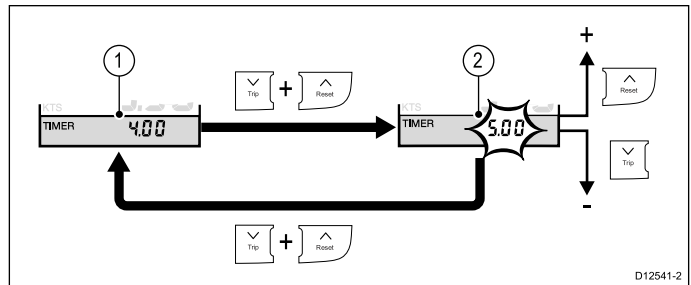

With a Race Timer isplayed

1. Press the **Trip** and **Reset** buttons at the same time to edit the timer.
2. Use the **Reset** button to increment the race timer start value, or
3. Use the **Trip** button to decrease the race timer start value.
4. Press the **Trip** and **Reset** buttons at the same time to confirm the new value.

Note: After a Race Timer has counted down to zero it will then start to count up.

Timer buzzer

The Timer buzzer is enabled or disabled during calibration see the *User calibration* section.

When using a race timer with the timer buzzer enabled, the buzzer will:

- Short double beep every minute.
- 3 Long beeps at the start of the last 30 seconds.
- Short beep once for each of the last 10 seconds.
- Long beep at zero.

8.13 Alarms

Alarms alert you to a situation or hazard requiring your attention.

You can set up alarms to alert you to certain conditions.

Alarms are raised by system functions, and also external equipment connected to your display.

When an alarm event occurs an audible and visual alarm is activated which indicates the alarm state.

Alarm thresholds can be configured from the relevant alarm page / menu.

Instrument alarms

The alarms available for the i50 Depth and i50 Tridata are listed below.

- Shallow depth alarm
- Deep depth alarm
- Shallow anchor alarm
- Deep anchor alarm

Alarm indications

An alarm event is indicated by both audible and visual warnings.

Shallow alarm



Deep alarm



Shallow anchor alarm



Deep anchor alarm



Alarms are sounded when the set alarm threshold value is crossed. Alarms will sound until silenced.

Silencing alarms

1. Press any button to silence an active alarm.

Enabling / Disabling alarms

Alarms can be enabled or disabled at any time.

With the relevant alarm page displayed:

1. Press and hold the **Reset** button for 1 second to switch the alarm on or off.

Setting alarm thresholds

You can adjust the threshold at which alarms are triggered by following the steps below.

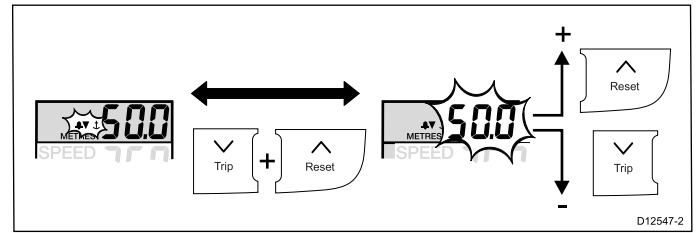

With the relevant alarm page displayed:

1. Press the **Trip** and **Reset** buttons at the same time.
The current alarm threshold will start to flash.
2. Use the **Reset** button to increase the alarm threshold.
3. Use the **Trip** button to decrease the alarm threshold.
4. The alarm threshold page will time-out after approximately 6 seconds of inactivity, automatically saving the new alarm threshold.

8.14 Illumination

Adjusting the backlight level — i50 Tridata

The backlighting level can be accessed using the Depth button.

During normal operation:

1. Press and hold the **Depth** button for approximately 2 seconds to display the Backlight page.

LAMPS is displayed on-screen and the current backlight level.

2. Use the **Reset** button to increase the backlight setting to the required level.
3. Use the **Trip** button to increase the backlight setting to the required level.

The backlight level can be adjusted from level 1 to 9 or switched Off (default).

Note: The backlight page will time-out after 8 seconds of inactivity.

Adjusting the contrast — i50 Tridata

The contrast level can be accessed using the Depth button.

During normal operation:

1. Press and hold the **Depth** button for approximately 4 seconds to display the Contrast page.

CONTRAST is displayed on-screen and the current contrast level.

2. Use the **Depth** button to cycle through the available contrast levels.

The contrast level can be adjusted from level 0 (default) to 3.

Note: The contrast page will time-out after 8 seconds of inactivity.

Group illumination

Group illumination is used to synchronizes and control the backlighting level of multiple units assigned to the same group.

The unit can participate in shared illumination via a SeaTalk network or group illumination via a SeaTalk^{ng} network.

When connected on a SeaTalk network all compatible units will share their backlight level (when 1 unit's backlighting level is adjusted all other units backlight level will also change).

When connected on a SeaTalk^{ng} network the unit can participate in group illumination and be assigned to a group of units which will share their backlighting levels. Available groups are as follows:

- OFF (default) — Group illumination is switched off
- HL1 — Helm 1
- HL2 — Helm 2
- CPt — Cockpit

- FLY — Flybridge
- NST — Mast
- GP1 to GP5 — User defined groups

When assigned to a group, when the backlighting of 1 unit is adjusted the backlighting level of all units assigned to the same group will also change.

Assigning the i50 Tridata to a group

To assign the i50 Tridata as part of a group so that it can participate in group illumination follow the steps below.

During normal operation:

1. Press and hold the **Depth** and **Speed** buttons at the same time for 6 seconds, until the Group illumination page is displayed.

GROUP CAL is displayed on-screen.

Note: The Group illumination entry page is a temporary page and will time-out to the previous page after 8 seconds.

2. Press the **Depth** button to display the **Groups** page.
3. Press the **Trip** and **Reset** buttons at the same time to enable selection of a group.
The group setting will flash.
4. Use the **Reset** button to cycle upwards through the list of available groups.
5. Use the **Trip** button to cycle back down through the list.
6. Press the **Trip** and **Reset** buttons at the same time to assign the display to the selected group.
The group setting will stop flashing.
7. Press and hold the **Depth** and **Speed** buttons at the same time for approximately 2 seconds to return to normal operation.

Chapter 9: Maintaining your display

Chapter contents

- 9.1 Service and maintenance on page 70
- 9.2 Condensation on page 70
- 9.3 Routine equipment checks on page 71
- 9.4 Cleaning on page 71
- 9.5 Cleaning the display case on page 72
- 9.6 Cleaning the display screen on page 72

9.1 Service and maintenance

This product contains no user serviceable components. Please refer all maintenance and repair to authorized Raymarine dealers. Unauthorized repair may affect your warranty.

9.2 Condensation

Certain atmospheric conditions may cause a small amount of condensation to form on the unit's window. This will not damage the unit and will clear after the unit has been switched on for a short period.

9.3 Routine equipment checks

Raymarine strongly recommends that you complete a number of routine checks to ensure the correct and reliable operation of your equipment.

Complete the following checks on a regular basis:

- Examine all cables for signs of damage or wear and tear.
- Check that all cables are securely connected.

9.4 Cleaning

Best cleaning practices.

When cleaning this product:

- Do NOT wipe the display screen with a dry cloth, as this could scratch the screen coating.
- Do NOT use abrasive, or acid or ammonia based products.
- Do NOT use a jet wash.

9.5 Cleaning the display case

The display unit is a sealed unit and does not require regular cleaning. If it is necessary to clean the unit, follow this basic procedure:

1. Switch off the power to the display.
2. Wipe the display with a clean, soft cloth (a microfibre cloth is ideal).
3. If necessary, use a mild detergent to remove grease marks.

Note: Do NOT use solvents or detergents on the screen itself.

Note: In certain conditions, condensation may appear inside the display screen. This will not harm the unit, and can be cleared by powering on the display for a short time.

9.6 Cleaning the display screen

A coating is applied to the display screen. This makes it water repellent, and prevents glare. To avoid damaging this coating, follow this procedure:

1. Switch off the power to the display.
2. Rinse the screen with fresh water to remove all dirt particles and salt deposits.
3. Allow the screen to dry naturally.
4. If any smears remain, very gently wipe the screen with a clean microfibre cleaning cloth (available from an opticians).

Chapter 10: Troubleshooting

Chapter contents

- [10.1 Troubleshooting on page 74](#)
- [10.2 Instrument troubleshooting on page 75](#)
- [10.3 Power up troubleshooting on page 76](#)
- [10.4 Miscellaneous troubleshooting on page 77](#)

10.1 Troubleshooting

The troubleshooting information provides possible causes and corrective action required for common problems associated with marine electronics installations.

All Raymarine products are, prior to packing and shipping, subjected to comprehensive test and quality assurance programs. However, if you experience problems with the operation of your product this section will help you to diagnose and correct problems in order to restore normal operation.

If after referring to this section you are still having problems with your unit, please contact Raymarine Technical Support for further advice.

10.2 Instrument troubleshooting

Fault	Cause	Action
Blank display.	No power supply.	<ul style="list-style-type: none"> • Check fuse / circuit breaker. • Check power supply. • Check SeaTalk / SeaTalk^{ng} cabling and connector security.
SeaTalk / SeaTalk ^{ng} information not being transferred between instruments.	SeaTalk / SeaTalk ^{ng} cabling or connector fault.	<ul style="list-style-type: none"> • Check security of SeaTalk / SeaTalk^{ng} connections between units. • Check condition of SeaTalk / SeaTalk^{ng} cables. • Isolate faulty unit by disconnecting units one by one.
A group of SeaTalk / SeaTalk ^{ng} units not working.	SeaTalk / SeaTalk ^{ng} cabling or connector fault.	<ul style="list-style-type: none"> • Check the security of SeaTalk / SeaTalk^{ng} connectors between functioning and non-functioning units. • Check the condition of SeaTalk / SeaTalk^{ng} cable between functioning and non-functioning units.
LAST flashing or dashes displayed continuously (depth greater than 3 feet).	Transducer cable or connector fault.	<ul style="list-style-type: none"> • Check condition of the transducer cable(s) and the security of the connections.
LAST flashes when under way.	Aerated water due to vessel wakes, propeller wash etc.	<ul style="list-style-type: none"> • Ensure reading stabilizes when clear of disturbed water.

10.3 Power up troubleshooting

Problems at power up and their possible causes and solutions are described here.

Problem	Possible causes	Possible solutions
The system (or part of it) does not start up.	Power supply problem.	Check relevant fuses and breakers.
		Check that the power supply cable is sound and that all connections are tight and free from corrosion.
		Check that the power source is of the correct voltage and sufficient current.

10.4 Miscellaneous troubleshooting

Miscellaneous problems and their possible causes and solutions are described here.

Problem	Possible causes	Possible solutions
Display behaves erratically: <ul style="list-style-type: none"> • Frequent unexpected resets. • System crashes or other erratic behavior. 	Intermittent problem with power to the display.	Check relevant fuses and breakers.
		Check that the power supply cable is sound and that all connections are tight and free from corrosion.
		Check that the power source is of the correct voltage and sufficient current.
	Software mismatch on system (upgrade required).	Go to www.raymarine.com and click on support for the latest software downloads.
	Corrupt data / other unknown issue.	Perform a factory reset. <div style="border: 1px solid black; padding: 5px; margin-top: 5px;"> <p>Important: This will result in the loss of any settings and data (such as waypoints) stored on the product. Save any important data to a memory card before resetting.</p> </div>

Chapter 11: Technical support

Chapter contents

- [11.1 Raymarine customer support on page 80](#)
- [11.2 Checking the software version on page 80](#)

11.1 Raymarine customer support

Raymarine provides a comprehensive customer support service. You can contact customer support through the Raymarine website, telephone and e-mail. If you are unable to resolve a problem, please use any of these facilities to obtain additional help.

Web support

Please visit the customer support area of our website at:

www.raymarine.com

This contains Frequently Asked Questions, servicing information, e-mail access to the Raymarine Technical Support Department and details of worldwide Raymarine agents.

Telephone and e-mail support

In the USA:

- **Tel:** +1 603 324 7900
- **Toll Free:** +1 800 539 5539
- **E-mail:** support@raymarine.com

In the UK, Europe, and the Middle East:

- **Tel:** +44 (0)13 2924 6777
- **E-mail:** ukproduct.support@raymarine.com

In Southeast Asia and Australia:

- **Tel:** +61 (0)29479 4800
- **E-mail:** aus.support@raymarine.com

Product information

If you need to request service, please have the following information to hand:

- Product name.
- Product identity.
- Serial number.
- Software application version.
- System diagrams.

You can obtain this product information using the menus within your product.

11.2 Checking the software version

Depending on the instrument display variant follow the steps below to identify the software version of your unit.

During normal operation:

1. **i50 Depth** — Press and hold the **Depth** and **Alarm** buttons at the same time for approximately 4 seconds.
2. **i50 Speed** — Press and hold the **Speed** and **Trip** buttons at the same time for approximately 4 seconds.
3. **i50 Tridata** — Press and hold the **Depth** and **Speed** buttons at the same time for approximately 4 seconds.

The software version will be displayed on-screen.

Chapter 12: Technical specification

Chapter contents

- [12.1 Technical specification on page 82](#)

12.1 Technical specification

Nominal supply voltage	12 V dc
Operating voltage range	10 V dc to 16 V dc
Power consumption	<ul style="list-style-type: none">• < 1 W Typical (Display only)• 2.4 W Maximum (Transducer connected)
Current	<ul style="list-style-type: none">• 45 to 65 mA Typical (Display only)• 200 mA Maximum (Transducer connected)
LEN (Refer to SeaTalk ^{ng} reference manual for further information.)	4
Environmental	Operating temperature: -20°C to +55°C Storage temperature: -30°C to +70°C Relative humidity: 93% Water proofing: IPX6
Connections	<ul style="list-style-type: none">• 2 x SeaTalk^{ng} connections (compliant with SeaTalk)• Transducer connections
Conformance	Europe 2004/108/EC

Chapter 13: Spares and accessories

Chapter contents

- [13.1 Spares on page 84](#)
- [13.2 SeaTalk^{ng} cables and accessories on page 84](#)
- [13.3 Converters on page 85](#)

13.1 Spares

The table below lists the spare parts available for i50 instrument displays

Description	Part number	Note
i50 / i60 / i70 front bezel	R22168	
i50 / i60 / i70 Sun cover	R22169	
i50 Depth keypad	R70131	
i50 Speed keypad	R70130	
i50 Tridata keypad	R70132	

13.2 SeaTalk^{ng} cables and accessories

SeaTalk^{ng} cables and accessories for use with compatible products.

Description	Part No	Notes
SeaTalk ^{ng} starter kit	T70134	Includes: <ul style="list-style-type: none"> • 1 x 5 Way connector (A06064) • 2 x Backbone terminator (A06031) • 1 x 3 m (9.8 ft) spur cable (A06040) • 1 x Power cable (A06049)
SeaTalk ^{ng} Backbone Kit	A25062	Includes: <ul style="list-style-type: none"> • 2 x 5 m (16.4 ft) Backbone cable (A06036) • 1 x 20 m (65.6 ft) Backbone cable (A06037) • 4 x T-piece (A06028) • 2 x Backbone terminator (A06031) • 1 x Power cable (A06049)
SeaTalk ^{ng} 0.4 m (1.3 ft) spur	A06038	
SeaTalk ^{ng} 1 m (3.3 ft) spur	A06039	
SeaTalk ^{ng} 3 m (9.8 ft) spur	A06040	
SeaTalk ^{ng} 5 m (16.4 ft) spur	A06041	
SeaTalk ^{ng} 0.4 m (1.3 ft) elbow spur	A06042	
SeaTalk ^{ng} 0.4 m (1.3 ft) backbone	A06033	
SeaTalk ^{ng} 1 m (3.3 ft) backbone	A06034	
SeaTalk ^{ng} 3 m (9.8 ft) backbone	A06035	
SeaTalk ^{ng} 5 m (16.4 ft) backbone	A06036	
SeaTalk ^{ng} 9 m (29.5 ft) backbone	A06068	
SeaTalk ^{ng} 20 m (65.6 ft) backbone	A06037	
SeaTalk ^{ng} to bare ends 1 m (3.3 ft) spur	A06043	
SeaTalk ^{ng} to bare ends 3 m (9.8 ft) spur	A06044	

Description	Part No	Notes
SeaTalk ^{ng} Power cable	A06049	
SeaTalk ^{ng} Terminator	A06031	
SeaTalk ^{ng} T-piece	A06028	Provides 1 x spur connection
SeaTalk ^{ng} 5-way connector	A06064	Provides 3 x spur connections
SeaTalk ^{ng} backbone extender	A06030	
SeaTalk to SeaTalk ^{ng} converter kit	E22158	Allows the connection of SeaTalk devices to a SeaTalk ^{ng} system.
SeaTalk ^{ng} Inline terminator	A80001	Provides direct connection of a spur cable to the end of a backbone cable. No T-piece required.
SeaTalk ^{ng} Blanking plug	A06032	
ACU / SPX SeaTalk ^{ng} spur cable 0.3 m (1.0 ft)	R12112	Connects an SPX course computer or an ACU to a SeaTalk ^{ng} backbone.
SeaTalk (3 pin) to SeaTalk ^{ng} adaptor cable 0.4 m (1.3 ft)	A06047	
SeaTalk to SeaTalk ^{ng} spur 1 m (3.3 ft) spur	A22164	
SeaTalk2 (5 pin) to SeaTalk ^{ng} adaptor cable 0.4 m (1.3 ft)	A06048	
DeviceNet adaptor cable (Female)	A06045	Allows the connection of NMEA 2000 devices to a SeaTalk ^{ng} system.
DeviceNet adaptor cable (Male)	A06046	Allows the connection of NMEA 2000 devices to a SeaTalk ^{ng} system.
DeviceNet adaptor cable (Female) to bare ends.	E05026	Allows the connection of NMEA 2000 devices to a SeaTalk ^{ng} system.
DeviceNet adaptor cable (Male) to bare ends.	E05027	Allows the connection of NMEA 2000 devices to a SeaTalk ^{ng} system.

13.3 Converters

Part number	Description
E22158	SeaTalk to SeaTalk ^{ng} Converter

Appendix A NMEA 2000 sentences

The i50 instrument range supports the following NMEA 2000 Parameter Group Number (PGN) sentences.

PG name	PGN	i50 Depth Transmit	i50 Depth Receive	i50 Speed Transmit	i50 Speed Receive	i50 Tridata Transmit	i50 Tridata Receive
ISO Acknowledgement	59392	•		•		•	
ISO Request	59904		•		•		•
ISO Address claim	60928	•	•	•	•	•	•
ISO Commanded address	65240		•		•		•
NMEA Request group function	126208		•		•		•
NMEA Command group function	126208		•	•	•	•	•
NMEA Acknowledge group function	126208	•		•	•	•	•
PGN list — Transmit PGN's group function	126464	•		•		•	
PGN list — Received PGN's groupfunction	126464	•		•		•	
Product information	126996	•	•	•	•	•	•
Speed	128259			•	•	•	•
Water depth	128267	•	•			•	•
Distance log	128275			•	•	•	•
COG & SOG rapid update	129026				•		•
GNSS Position data	129029				•		•
Wind data	130306				•		•
Environmental parameters	130310			•	•	•	•
Environmental parameters	130311				•		•
Temperature	130312			•	•	•	•

Raymarine[®]
A FLIR COMPANY