

TACO
MARINE

RUB RAIL

Replacement Selection Guide



2017

BEFORE YOU BEGIN

The TACO Marine Rub Rail Replacement Guide cross-references the original factory Rub Rail used by over 80 of the leading boat manufacturers since 1993. Follow these steps to find the Rub Rail that you need:

1. Look up the make of your boat
2. Match the Rub Rail and insert to your existing rail (all profiles are to scale)
3. Choose the preferred color
4. Call a distributor or retailer to verify availability of the suggested Rub Rail
5. Place order and get confirmation

ESTIMATING RUB RAIL LENGTH

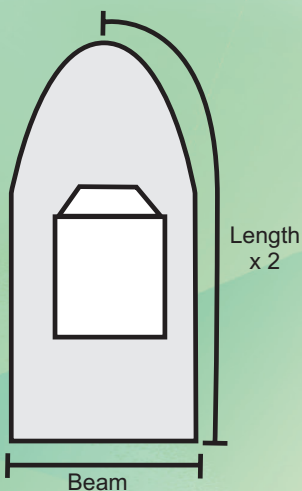

1. Take the length and width (beam) of your boat.
2. Multiply length by two and add beam.
3. This total will give you the **MINIMUM** length of rub rail required for your boat in feet.

ORIGINAL & COMPATIBLE

TACO Marine supplies the original rub rail to most of the builders listed in this guide. Compatible rub rails are provided for those boats where the builder has more than one supplier or uses a competitor's product. In most cases, the product is virtually identical and interchangeable for all practical purposes. However, on older boats, the original rub rail may not be the current one installed.



TOOLS & SUPPLIES NEEDED

- > Rub Rail, insert (if required)
- > Measuring tape
- > Safety goggles or glasses
- > Two cordless drills (one for a screw driver bit and one for a drill bit)
- > Putty knife or scraper
- > Caulking gun with silicone sealant or a tube of 3M 5200
- > Metal file or coarse sandpaper to remove burrs
- > Heat gun (for rigid vinyl Rub Rail with flexible inserts)
- > Garden shears (for cutting flexible vinyl rub rail with insert) or hacksaw/ power saw and cutoff wheel (for cutting Stainless Steel overlaps)
- > Miter box (for metal and rigid vinyl Rub Rail)
- > Rubber mallet
- > Proper size and type fasteners
- > Work gloves for good grip and handling materials that may be heated from exposure to the sun

COLOR GUIDE*

Colors specified in this catalog reflect TACO Marine's standard Rub Rail colors. Other colors are available provided minimum quantity requirements are met and sufficient lead-time is given.

BKA

Black

CRA

Buff

GRA

Medium Gray

GRS

Gray

WHA

Arctic White

WHC

Frosty White

WHD

Silver White

WHN

Cream

CP

Chrome
Polished

**DUE TO VARIATIONS IN THE PRINTING PROCESS, COLOR MAY VARY SLIGHTLY FROM THE ORIGINAL PRODUCT. COLOR SAMPLES AVAILABLE ON REQUEST.*

- > Ensure the length of the Rub Rail is sufficient for your boat. It is always best to buy an extra 10' for trial and error.
- > Make sure to purchase all the materials needed (Rub Rail, insert, fasteners, end caps, splice caps, etc...) to complete the job.
- > Carefully read all the instructions before beginning and/or watch the TACO Marine Rub Rail Installation Video which you can view online at tacomarine.com.
- > You can replace your rub rail with a factory replacement style or a completely different look. Regardless of the material originally installed by the builder of your boat, feel free to choose the material and style you desire.
- > It is easier to install if you remember to choose a rub rail that is at least the same height as the original.
- > Flexible vinyl rub rail is the easiest to bend and provides a cushioning effect when in use against normal bumps from pilings and docks.
- > Rigid vinyl, as well as aluminum rub rail with flexible vinyl insert, performs well, lasts long and is easy to install in straight runs.
- > Rigid vinyl rub rail with stainless steel overlap provides the best protection and the longest useful life.



BOAT BUILDERS



Rub Rail	Page	Insert	Page
Action Craft			
V11-3447	25	V12-0003	30
V11-4014	25	A40-0812: 5/8" Rope Stiffener	35
V21-9517	14	V12-0303	31



Rub Rail	Page	Insert	Page
Alden Yachts			
S11-451	27	N/A	N/A
S11-4650	29	N/A	N/A
S11-467	28	N/A	N/A



Rub Rail	Page	Insert	Page
Alumacraft			
N/A	N/A	V12-0342	32



Rub Rail	Page	Insert	Page
Angler			
V11-0809	24	V12-0005	30
V11-2423	24	V12-0003	30
V11-4135	38	N/A	N/A
V21-9501	14	V12-0303	31



Rub Rail	Page	Insert	Page
Aquasport			
V11-2423	24	V12-0003	30
V21-9501	14	V12-0303	31



Rub Rail	Page	Insert	Page
Astro Boats			
V21-9678	15	V12-4144	33



Rub Rail	Page	Insert	Page
Baja Boats			
V21-9517	14	V12-0303	31



Rub Rail	Page	Insert	Page
Bayliner			
A11-0342	19	V12-0342	32
A11-0347	19	V12-4155	33
A12-0303	20	V12-0303	31
A12-0305	20	V12-0303	31
V11-2423	24	V12-0303	31
V21-0188	16	N/A	N/A
V21-3670	18	N/A	N/A
V21-9501	14	V12-0303	31
V21-9678	15	V12-4144	33



Rub Rail	Page	Insert	Page
Bertram			
A11-0511	21	N/A	N/A



Rub Rail	Page	Insert	Page
Black Fin			
V21-0457	17	N/A	N/A
V21-9679	11	S11-4650	29
V21-9681*	N/A	S11-4511	28
V21-9866	12	S11-4511	28
V11-2423	24	V12-0303	31

* Denotes Rub Rail that is no longer in stock / please contact tacomarine.com for more information



Rub Rail	Page	Insert	Page
Bluefin			
V21-3670	18	N/A	N/A
V21-9502	9	S11-4650	29
V21-9659	11	S11-4511	28
V21-9662	15	V12-1069	32
V21-9679	11	S11-4511	28



Bombardier			
V21-9501	14	V12-0303	31



Boston Whaler			
A11-0347	19	V12-4155	33
V11-0899	24	V12-0005	30
V11-2423	24	V12-0003	30
V21-9678	15	V12-4144	33
V21-9692*	N/A	V12-4073*	N/A



Carolina Skiff			
V21-9613*	N/A	V12-0307	31
V21-9659	11	S11-4511	28
V21-9662	15	V12-1069	32
V21-9863*	N/A	V12-0307	31



Century			
A11-0638	20	V12-0338	32
S11-4670	29	N/A	N/A
V21-9501	14	V12-0303	31
V21-9678	15	V12-4144	33



Chaparral Boats			
A11-0638	20	V12-0338	32
V21-9659	11	S11-4511	28
V21-9678	15	V12-4144	33



Chris Craft Boats			
A11-0152	21	N/A	N/A
V11-9669	26	S11-4690	29
V21-9659	11	S11-4511	28



Cobalt (aka Fiberglass Engineering)			
V11-9669	26	S11-4690	29



Cobia			
A11-0638	20	V12-0338	32
S11-4670	29	N/A	N/A
V21-9501	14	V12-0303	31
V21-9678	15	V12-4144	33



Contender			
V11-2423	24	V12-0003	30
V21-3670	18	N/A	N/A
V21-9501	14	V12-0303	31
V21-9517	14	V12-0303	31
V21-9602	14	V12-0303	31

* Denotes Rub Rail that is no longer in stock / please contact tacomarine.com for more information

Correct Craft Inc.

Rub Rail	Page	Insert	Page
Correct Craft			
A11-0152	21	N/A	N/A
V11-3447	25	V12-0003	30
V11-9798*	N/A	S11-4511	28
V21-0460	17	N/A	N/A



Crestliner			
V11-3447	25	V12-0003	30
V21-9501	14	V12-0303	31



Crownline			
V21-9866	12	S11-4511	28



Donzi			
A11-0152	21	N/A	N/A
V11-9669	26	S11-4690	29
V21-9602	14	V12-0303	31



Doral			
V21-0188	16	S11-4511	28



Dusky			
V11-2423	24	V12-0003	30



Ebbtide Boats			
V21-9659*	N/A	S11-4511	28
V21-9678	15	V12-4144	33



Edgewater			
V21-9502	9	S11-4670	29
V21-9677*	N/A	S11-4650	29



Everglades Boats			
V21-9502	9	S11-4511	28
V21-9678	15	V12-4144	33
V21-9866	12	S11-4650	29



Formula			
V21-1025	9	S11-4511	28
V21-3671	18	N/A	N/A
V21-9602	14	V12-0303	31



Fountain Powerboats			
A11-0152	21	N/A	N/A
A11-0342	19	V12-0342	32
V21-3670	18	N/A	N/A
V21-9602	14	V12-0303	31
V21-9648	10	S11-4511	28
V21-9679	11	S11-4511 or S11-4650	28 or 29



Four Winns			
A11-0638	20	V12-0338	32
V21-1025	9	S11-4511	28
V21-9501	14	V12-0303	31
V21-9517	14	V12-0303	31
V21-9659	11	S11-4511	28
V21-9662	15	V12-1069	32
V21-9811	26	V12-9809	34

* Denotes Rub Rail that is no longer in stock / please contact tacomarine.com for more information



Rub Rail	Page	Insert	Page
Gambler			
V11-4014	25	V12-0003	30



Glacier Bay Catamarans			
V11-0809	24	V12-0810	32
V21-9501	14	V12-0303	31
V21-9659	11	S11-4511	28



Glastron/Larson			
A11-0638	20	V12-0338	32
A12-0303	20	V12-0303	31
V21-9501	14	V12-0303	31
V21-9659	11	S11-4511	28
V21-9662	15	V12-1069	32
V21-9811	26	V12-9809	34



Grady White			
A11-0151	21	N/A	N/A
V11-2423	24	V12-0003	30
V21-9866	12	S11-4511	28



Hunter Marine			
V11-0809	24	V12-0810	32
V11-3161	25	V22-3162	30
V11-9795	38	V12-4144	33
V21-9647	10	S11-4511	28



Hydrasports			
V11-4014	25	V12-0003	30
V21-3670	18	N/A	N/A



Intrepid			
V21-9681*	N/A	S11-4511	28
V21-9866	12	S11-4511	28



Jupiter			
V21-9659	11	S11-4511	28
V21-9679	11	S11-4511	28



Key West Boats			
V11-4014	25	V12-0003	30
V21-9659	11	S11-4511	28
V21-9662	15	V12-1069	32



Larson Boats			
V21-9501	14	V12-0303	31
V21-9662	15	V12-1069	32



Low Boats			
V21-9602	14	V12-0303	31



Luhrs			
A11-0151	21	N/A	N/A
A11-0152	21	N/A	N/A
S11-451	27	N/A	N/A
S11-465	27	N/A	N/A
V21-9647	10	S11-4511	28

* Denotes Rub Rail that is no longer in stock / please contact tacamarine.com for more information



Rub Rail	Page	Insert	Page
Mainship			
S11-465	27	N/A	N/A
V21-9647	10	S11-4511	28



Mako			
V11-0899	24	V12-0005	30
V11-2423	24	V12-0003	30
V21-9517	14	V12-0303	31



Malibu			
V21-9863*	N/A	V12-0307	31



Mariah Boats			
A11-0638	20	V12-0338	32
V21-9501	14	V12-0303	31



Mastercraft Boats			
A11-0151	21	N/A	N/A
V21-9517	14	V12-0003	30
V21-9613*	N/A	S11-4510*	N/A
V21-9648	10	S11-4511	28



Maverick (Cobia & Pathfinder)			
A11-0152	21	N/A	N/A
V21-9501	14	V12-0303	31
V21-9648	10	S11-4511	28
V21-9811	26	V12-9809	34
V21-9866	12	S11-4511	28



Maxum			
A11-0342	19	V12-0342	32
A11-0347	19	V12-4155	33
A12-0303	20	V12-0303	31
A12-0305	20	V12-0303	31
V11-2423	24	V12-0003	30
V21-0188	16	N/A	N/A
V21-3670	18	N/A	N/A
V21-9501	14	V12-0303	31



Monterey Boats / Sebring Marine			
V21-9501	14	V12-0303	31
V21-9659	11	S11-4511	28
V21-9679	11	S11-4511 or S11-4650	28 or 29
V21-9811	26	S11-4511	28



Parker			
V21-9959	13	S11-4511	28



Pro-Line Boats			
A11-0152	21	N/A	N/A
V11-9669	26	S11-4690	29
V21-3670	18	N/A	N/A
V21-9602	14	V12-0303	31
V21-9678	15	V12-4144	33



Pro Sport Boats			
V21-9662	15	V12-1069	32

* Denotes Rub Rail that is no longer in stock / please contact tacomarine.com for more information



Rub Rail	Page	Insert	Page
Pursuit			
A11-0152	21	N/A	N/A
V21-9790	12	S11-4650	29
V21-9866	12	S11-4511	28



Regal Marine			
A11-0152	21	N/A	N/A
V11-2423	24	V12-0003	30
V21-1025	9	S11-4511	28
V21-9501	14	V12-0307	31
V21-9502	9	S11-4650	29
V21-9659	11	S11-4511	28
V21-9799*	N/A	S11-4511	28



Rinker			
V21-9659	11	S11-4511	28



Robalo			
V11-2423	24	V12-0003	30
V21-9678	15	V12-4144	33



Sailfish Boats			
V21-9501	14	V12-0303	31
V21-9648	10	S11-4511	28
V21-9659	11	S11-4511	28
V21-9678	15	V12-4144	33
V21-9679	11	S11-4511 or S11-4650	28 or 29



Scout			
V11-2423	24	V12-0003	30
V11-3447	25	V12-0003	30



Sea Craft			
V21-9679	11	S11-4511	28



Sea Fox			
V11-9798*	N/A	S11-4511	28



Sea Hunt			
V11-2423	24	V12-0003	30
V21-9866	12	S11-4650	29



Seahunter			
V21-9866	12	S11-4650	29
V21-9681*	N/A	S11-4511	28



Sea Pro			
V11-9798*	N/A	S11-4511	28



Sea Ray Boats			
V11-3447	25	V12-0003	30
V21-0188	16	N/A	N/A
V21-1025	9	S11-4511	28
V21-9501	14	V12-0303	31
V21-9517	14	V12-0003	30
V21-9526	10	S11-465	27
V21-9648	10	S11-4511	28
V21-9667	11	S11-4690	29
V21-9679	11	S11-4511	28
V21-9613*	N/A	S11-4510*	N/A
V21-9811	26	V12-9809	34

* Denotes Rub Rail that is no longer in stock / please contact tacomarine.com for more information



Rub Rail	Page	Insert	Page
Sea Swirl			
V21-9501	14	V12-0303	31
Shamrock			
A11-0514	22	N/A	N/A
V21-9679	11	S11-4511	28



Shearwater			
V21-9502	9	V12-5818	33
V21-9677*	N/A	V12-5818	33



Silverton			
V21-9648	10	S11-4511	28
V21-9678	15	V12-4144	33



Skeeter			
V21-9681*	N/A	S11-4511	28
V21-9866	12	S11-4511	28



Southwind			
V21-9659	11	S11-4511	28
V21-9678	15	V12-4144	33



Sport Craft			
A11-0342	19	V12-0342	32
V21-9501	14	V12-0303	31
V21-9602	14	V12-0303	31



Sportsman			
V21-9659	11	S11-4511	28
V21-9679	11	S11-4650	29
V21-9959	13	S11-4511	28
V21-9866	12	S11-4511	28



Starcraft			
V21-9678	15	V12-4144	33



Stingray			
V21-9659	11	S11-4511	28



Stratos Boats			
V21-9659	11	S11-4511	28



Sundance			
V15-9855*	N/A	N/A	N/A
V21-9659	11	S11-4511	28
V21-9959	13	S11-4511	28



Tahoe Boats			
A12-0303	20	V12-0303	31
V21-9501	14	V12-0303	31



Tennessee Watercraft / Yamaha			
V21-9517	14	V12-0003 / V12-0303	30 / 31
V21-9659	11	S11-4511	28

* Denotes Rub Rail that is no longer in stock / please contact tacomarine.com for more information



Rub Rail	Page	Insert	Page
Thunderbird			
A11-0151	21	N/A	N/A
V21-1025	9	S11-4511	28
V21-9602	14	V12-0303	31



Tiara			
V11-2423	24	V12-0003	30
V21-1039	9	S11-4650	29



Tidewater			
V21-9679	11	S11-4511	28
V21-9959	13	S11-4511	28



Tige Boats			
V21-9811	26	V12-9809	34



Triton Boats			
V11-9795	38	V12-4144	33
V11-9662*	N/A	V12-1069	32
V21-9790	12	V12-0303	31



Triumph Boats			
V21-9662	15	V12-1069	32



Trophy			
A11-0342	19	V12-0342	32
A11-0347	19	V12-4155	33
A12-0303	20	V12-0303	31
A12-0305	20	V12-0303	31
V11-2423	24	V12-0003	30
V21-0188	16	N/A	N/A
V21-3670	18	N/A	N/A
V21-9501	14	V12-0303	31
V21-9678	15	V12-4144	33



Wellcraft Marine			
A11-0317	19	V12-0317	31
V11-0899	24	V12-0005	30
V21-1025	9	S11-4511	28
V21-3670	18	N/A	N/A
V21-3671	18	N/A	N/A
V21-9501	14	V12-0303	31
V21-9602	14	V12-0303	31
V21-9647	10	S11-4511	28
V21-9659	11	S11-4511	28
V21-9678	15	V12-4144	33



World Class Catamarans			
V21-9659	11	S11-4511	28
V21-9662	15	V12-1069	32



Yellowfin			
V21-9662	15	V12-1069	32

* Denotes Rub Rail that is no longer in stock / please contact tacomarine.com for more information

RIGID VINYL

Widely used on all boats in a variety of shapes and sizes due to its superior protection and aesthetic appeal.

V21-1025

Insert: S11-4511

Part Number	Color	Length	Screw*
V21-1025WHC20D	Frosty White	20'	#10

**Drilled and countersunk on 6" centers / sold separately*

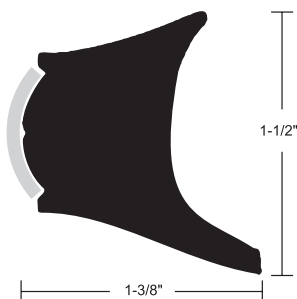

V21-1039

Insert: S11-4650

Part Number	Color	Length	Screw*
V21-1039BKA20D1	Black	20'	#8

**Drilled and countersunk on 12" centers / sold separately*

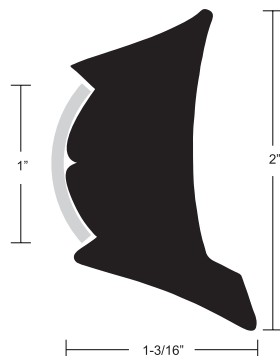

V21-9502

Insert: S11-4650

Part Number	Color	Length	Screw*
V21-9502BKA20D	Black	20'	#8
V21-9502WHC20DV05	Frosty White	20'	#8

**Drilled and countersunk on 8" centers / sold separately*

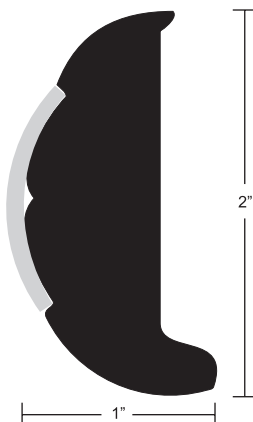

RIGID VINYL ACCEPTS STAINLESS STEEL INSERT

V21-9526

Insert: **S11-465S**

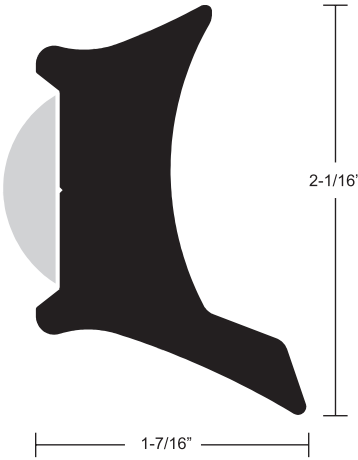

Part Number	Color	Length	Screw*
V21-9526WHC20D	Frosty White	20'	#12

**Drilled and countersunk on 6" centers / sold separately*

V21-9647

Insert: **S11-4511**

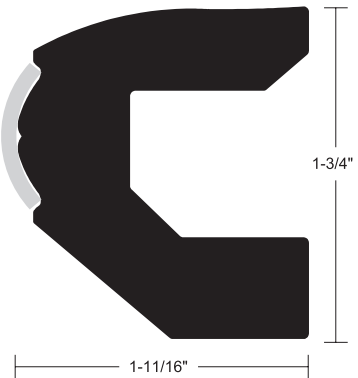

Part Number	Color	Length	Screw*
V21-9647WHA20D	Arctic White	20'	#10

**Drilled and countersunk on 12" centers / sold separately*

V21-9648

Insert: **S11-4511**

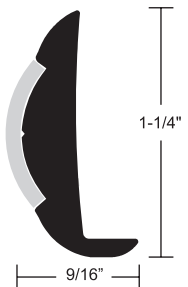

Part Number	Color	Length	Screw*
V21-9648WHC20D	Frosty White	20'	#8

**Drilled and countersunk on 8" centers / sold separately*

V21-9659

Insert: S11-4511

Part Number	Color	Length	Screw*
V21-9659BKA20D	Black	20'	#8

*Drilled and countersunk on 8" centers / sold separately

LED NAVIGATION LIGHTS AVAILABLE FOR THIS RUB RAIL
SEE RUB RAIL ACCESSORIES ON PAGE 36

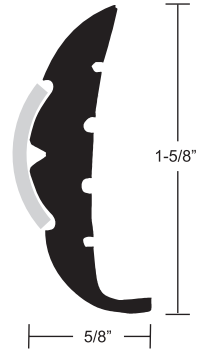

V21-9667

Insert: S11-4690

Part Number	Color	Length	Screw*
V21-9667WHC20D	Frosty White	20'	#10

*Drilled and countersunk on 6" centers / sold separately

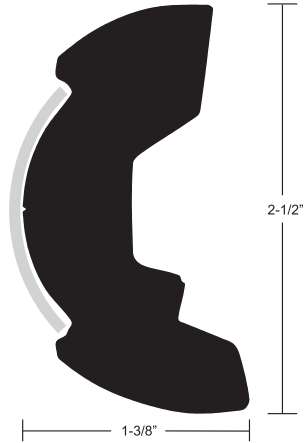

V21-9679

Insert: S11-4511

Part Number	Color	Length	Screw*
V21-9679BKA20D	Black	20'	#8
V21-9679WHC20D	Frosty White	20'	#8

*Drilled and countersunk on 8" centers / sold separately

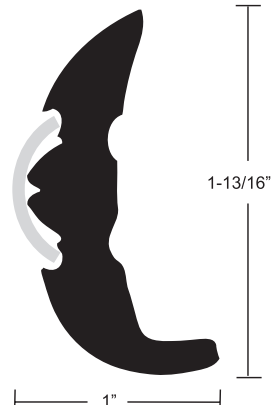

V21-9790

Insert: S11-4650

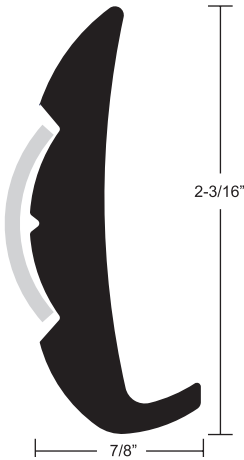

Part Number	Color	Length	Screw*
V21-9790BKA20D	Black	20'	#10

*Drilled and countersunk on 8" centers / sold separately

V21-9846

Insert: S11-4650

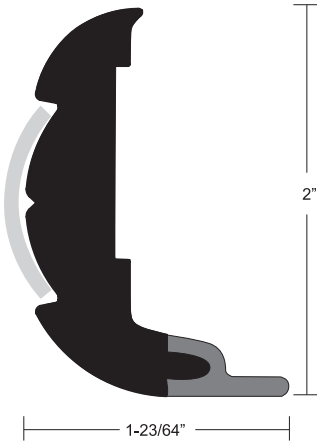

Part Number	Color	Length	Screw*
V21-9846WHC18D	Frosty White	18'	#8

*Drilled and countersunk on 6" centers / sold separately

V21-9866

Insert: S11-4511



Part Number	Color	Length	Screw*
V21-9866WHC20D	Frosty White	20'	#8

*Drilled and countersunk on 8" centers / sold separately

V21-9906

Flex Core

Insert: S11-4511

Part Number	Color	Length	Screw*
V21-9906BKA20D	Black	20'	#8
V21-9906BKA60D	Black	60'	#8
V21-9906WHC20D	Frosty White	20'	#8
V21-9906WHC50D	Frosty White	50'	#8
V21-9906WHC60D	Frosty White	60'	#8

*Drilled and countersunk on 8" centers / sold separately

LED NAVIGATION LIGHTS AVAILABLE FOR THIS RUB RAIL
SEE RUB RAIL ACCESSORIES ON PAGE 36

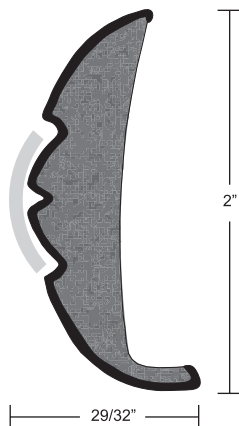

V21-9909

Flex Core

Insert: V12-9809 Flex Chrome

Part Number	Color	Length	Screw*
V21-9909BKA70D	Black	70'	#8
V21-9909WHC70D	Frosty White	70'	#8

*Drilled and countersunk on 8" centers / sold separately

LED NAVIGATION LIGHTS AVAILABLE FOR THIS RUB RAIL
SEE RUB RAIL ACCESSORIES ON PAGE 36

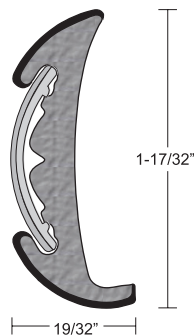

V21-9959

Flex Core

Insert: S11-4511

Part Number	Color	Length	Screw*
V21-9959BKA20D	Black	20'	#8
V21-9959BKA50D	Black	50'	#8
V21-9959WHC20D	Frosty White	20'	#8
V21-9959WHC50D	Frosty White	50'	#8
V21-9959WHC60D	Frosty White	60'	#8

*Drilled and countersunk on 8" centers / sold separately

LED NAVIGATION LIGHTS AVAILABLE FOR THIS RUB RAIL
SEE RUB RAIL ACCESSORIES ON PAGE 36

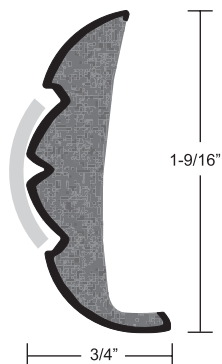

V21-9501

Insert: V12-0303

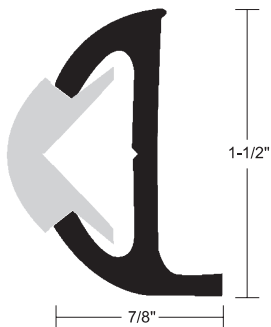

Part Number	Color	Length	Screw*
V21-9501WHC20D	Frosty White	20'	#10

*Drilled and countersunk on 6" centers / sold separately

V21-9517

Insert: V12-0303

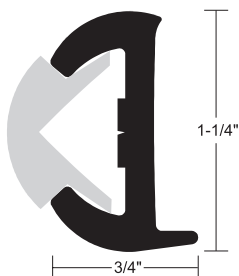

Part Number	Color	Length	Screw*
V21-9517BKA20D	Black	20'	#10

*Drilled for #10 screws on 6" centers / sold separately

V21-9602

Insert: V12-0303

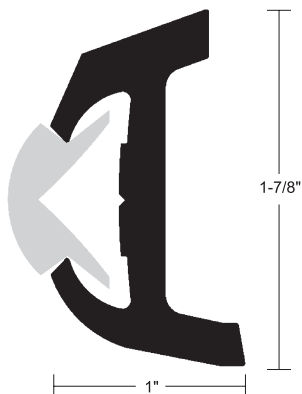

Part Number	Color	Length	Screw*
V21-9602WHA20D	Arctic White	20'	#10

*Drilled and countersunk on 8" centers / sold separately

V21-9678

Insert: V12-4144

Part Number	Color	Length	Screw*
V21-9678BKA20D	Black	20'	#8
V21-9678WHA20D	Arctic White	20'	#8

*Drilled and countersunk on 6" centers / sold separately

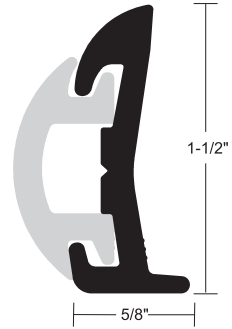

V21-9904

Insert: V12-0303

Part Number	Color	Length	Screw*
V21-9904BKA20D	Black	20'	#8
V21-9904WHC20D	Frosty White	20'	#8

*Drilled and countersunk on 8" centers / sold separately

LED NAVIGATION LIGHTS AVAILABLE FOR THIS RUB RAIL
SEE RUB RAIL ACCESSORIES ON PAGE 36

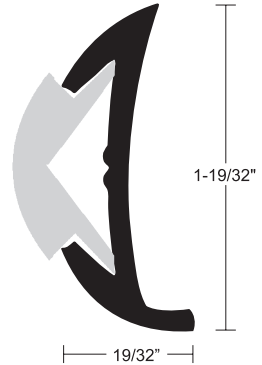

V21-9662

Insert: V12-1069 Flex Chrome

Part Number	Color	Length	Screw*
V21-9662BKA20D	Black	20'	#8
V21-9662WHC20D	Frosty White	20'	#8

*Drilled and countersunk on 8" centers / sold separately

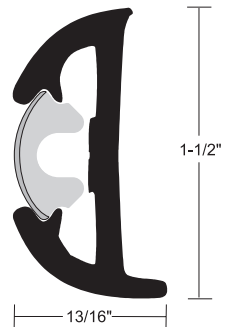

V21-0188

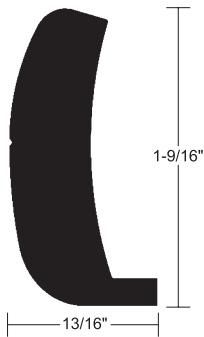

Part Number	Color	Length	Screw*
V21-0188BKA20D	Black	20'	#8

**Drilled and countersunk on 6" centers / sold separately*

V21-0205



Part Number	Color	Length	Screw*
V21-0205BKA20D	Black	20'	#10

**Drilled and countersunk on 8" centers / sold separately*

V21-0456

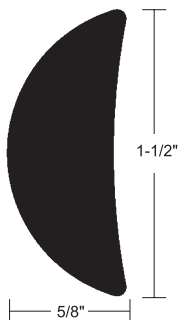

Part Number	Color	Length	Screw*
V21-0456BKA12D	Black	12'	#8

**Drilled and countersunk on 6" centers / sold separately*

V21-0457

Part Number	Color	Length	Screw*
V21-0457BKA20D	Black	20'	#8

*Drilled and countersunk for 6" centers / sold separately

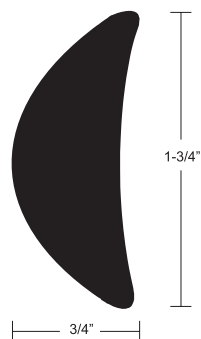

V21-0458

Part Number	Color	Length	Screw*
V21-0458BKA20D	Black	20'	#10

*Drilled and countersunk for 6" centers / sold separately

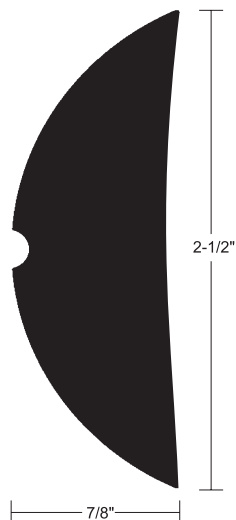

V21-0460

Part Number	Color	Length	Screw*
V21-0460BKA12D	Black	12'	#6

*Drilled and countersunk for 6" centers / sold separately

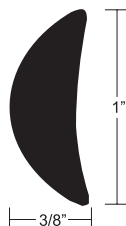

V21-0874

Spray Rail

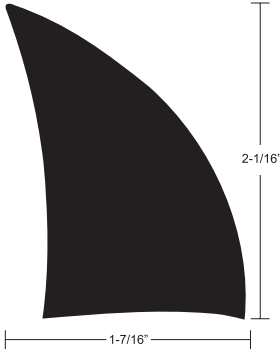

Part Number	Color	Length	Screw
V21-0874WHA18	Arctic White	18'	#10



Instructions online

V21-3670

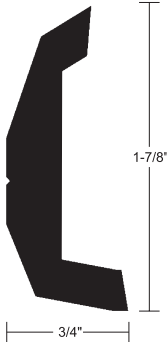

Part Number	Color	Length	Screw*
V21-3670BKA20D	Black	20'	#10
V21-3670WHA20D	Arctic White	20'	#10

*Drilled and countersunk on 8" centers / sold separately

V21-3671

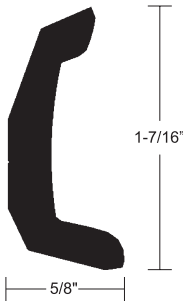

Part Number	Color	Length	Screw*
V21-3671BKA20D2	Black	20'	#10
V21-3671WHA20D2	Arctic White	20'	#10

*Drilled and countersunk on 8" centers / sold separately

V21-9140

Canoe Rail

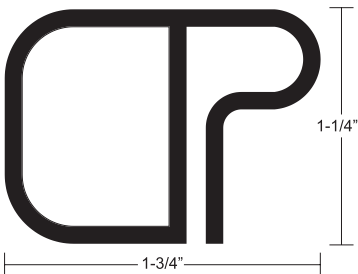

Part Number	Color	Length	Screw*
V21-9140BKA166	Black	16'6"	#8

*Self-tapping screws, bolts or pop rivets can be used / sold separately

RIGID VINYL WITH NO INSERT

ALUMINUM / STAINLESS STEEL

Durable, lightweight and resistant to corrosion.

A11-0317

Insert: V12-0317

Part Number	Finish	Length	Screw*
A11-0317TAL12D	Polished Clear	12'	#8

*Drilled and countersunk on 6" centers / sold separately

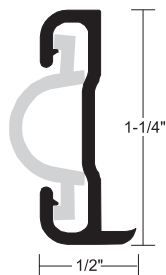

A11-0342

Insert: V12-0342

Part Number	Finish	Length	Screw*
A11-0342BLY12D	Polished Clear	12'	#8

*Drilled and countersunk on 6" centers / sold separately

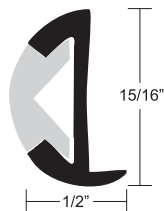

A11-0347

Insert: V12-4155

Part Number	Finish	Length	Screw*
A11-0347BLY12D	Brite	12'	#8

*Drilled and countersunk on 6" centers / sold separately

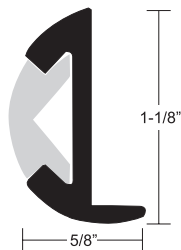

A11-0638

Insert: V12-0338

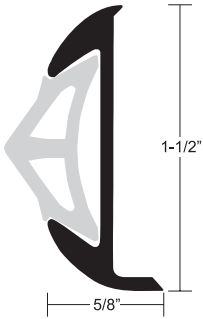

Part Number	Finish	Length	Screw*
A11-0638TAL12D	Polished Clear	12'	#8

*Drilled and countersunk on 6" centers / sold separately

A12-0303

Insert: V12-0303

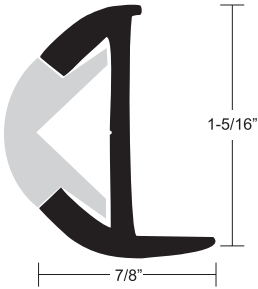

Part Number	Finish	Length	Screw*
A12-0303BLY12D	Brite	12'	#10

*Drilled and countersunk on 6" centers / sold separately

A12-0305

Insert: V12-0303

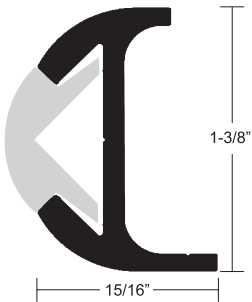

Part Number	Finish	Length	Screw*
A12-0305BLY12D	Brite	12'	#10

*Drilled and countersunk on 6" centers / sold separately

A11-0151

Part Number	Finish	Length	Screw*
A11-0151TAL12D	Anodized	12'	#8

*Drilled and countersunk on 6" centers / sold separately

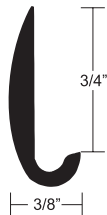

A11-0152

Part Number	Finish	Length	Screw*
A11-0152TAL12D-A	Polished Clear	12'	#8

*Drilled and countersunk on 6" centers / sold separately

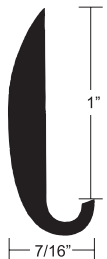

A11-0511

Part Number	Finish	Length	Screw*
A11-0511TAL20D	Polished Clear	20'	#10

*Drilled and countersunk on 6" centers / sold separately

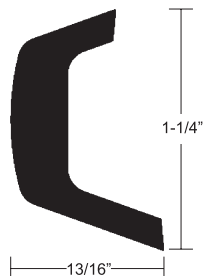

A11-0514

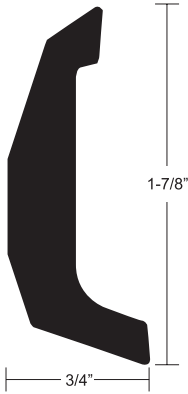

Part Number	Finish	Length	Screw*
A11-0514TAL20D	Polished Clear	20'	#10

**Drilled and countersunk on 6" centers / sold separately*

A50-0195



Part Number	Finish	Length	Screw*
A50-0195TAL12D	Polished Clear	12'	#5

**Drilled and countersunk on 6" centers / sold separately*

A50-0197



Part Number	Finish	Length	Screw*
A50-0197TAL12D	Polished Clear	12'	#6

**Drilled and countersunk on 6" centers / sold separately*

A50-0199

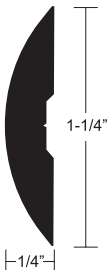

Part Number	Finish	Length	Screw*
A50-0199TAL12D1	Polished Clear	12'	#6

**Drilled and countersunk on 6" centers / sold separately*

V25-9815

Yacht Style

Insert: V12-9814

Part Number	Color / Finish	Length	Screw*
V25-9815WHA20D	Arctic White	20'	#8
S11-1950P16B	Polished Mirror	16'	#8
V12-9814BKA250	Black	250'	-

*Drilled and countersunk on 6" centers / sold separately

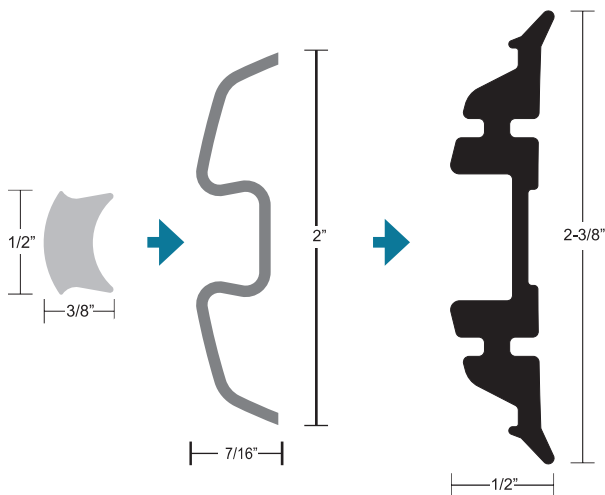

V12-9814 Insert

S11-1950 Stainless Steel

V25-9815

THREE-PART DESIGN

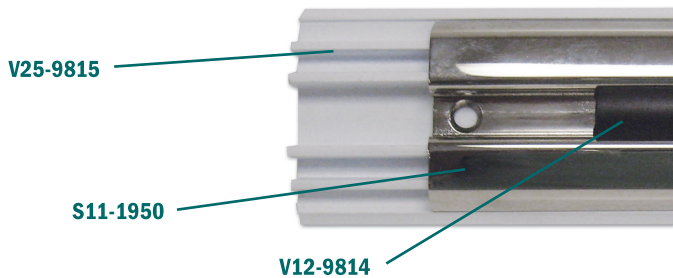

FLEXIBLE VINYL

Soft and easy to install in one continuous coil.

FLEXIBLE VINYL ACCEPTS FLEXIBLE INSERT

V11-0809

Insert: V12-0810

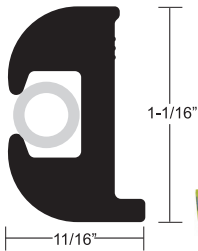

Part Number	Color	Length	Screw*
V11-0809BKA50-1	Black	50'	#8

**Drilled and countersunk on 6" centers / sold separately*



AVAILABLE as a RUB RAIL KIT (pg. 37)

V11-0899

Insert: V12-0005

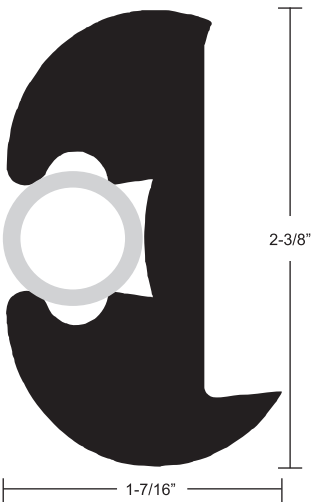

Part Number	Color	Length	Screw*
V11-0899BKA100	Black	100'	#10

**Drilled and countersunk on 6" centers / sold separately*

V11-2423

Insert: V12-0003

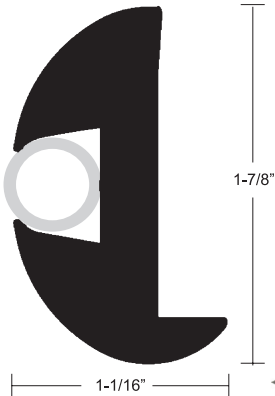

Part Number	Color	Length	Screw*
V11-2423BKA50-1	Black	50'	#10
V11-2423BKA70-1	Black	70'	#10
V11-2423BKA100-1	Black	100'	#10

**Drilled and countersunk on 6" centers / sold separately*



AVAILABLE as a RUB RAIL KIT (pg. 37)

FLEXIBLE VINYL ACCEPTS FLEXIBLE INSERT

technical hotline 800.653.8568 • tacomarine.com

V11-3161

Insert: V22-3162

Part Number	Color	Length	Screw
V11-3161BKA50-1	Black	50'	None

#10 screw intended for insert / drilled and countersunk on 6" centers / sold separately

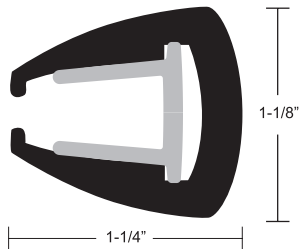

V11-3426

Insert: V12-0005

Part Number	Color	Length	Screw*
V11-3426BKA50-1	Black	50'	#8
V11-3426BKA70-1	Black	70'	#8

*Drilled and countersunk on 6" centers / sold separately

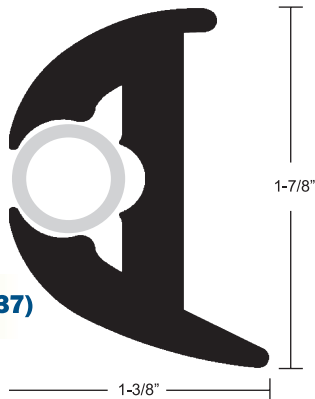

AVAILABLE as a RUB RAIL KIT (pg. 37)

V11-3447

Insert: V12-0003

Part Number	Color	Length	Screw*
V11-3447BKA50-1	Black	50'	#8
V11-3447BKA70	Black	70'	#8

*Drilled and countersunk on 6" centers / sold separately

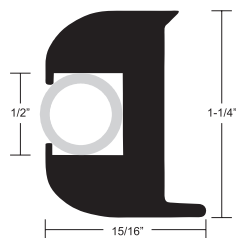

AVAILABLE as a RUB RAIL KIT (pg. 38)

V11-4014

Insert: V12-0003

Hull Stiffener: A40-0812 (recommended)

Part Number	Color	Length	Screw
V11-4014BKA70	Black	70'	None

#10 screw intended for use with hull stiffener (recommended with this Rub Rail / drilled and countersunk on 6" centers / sold separately)

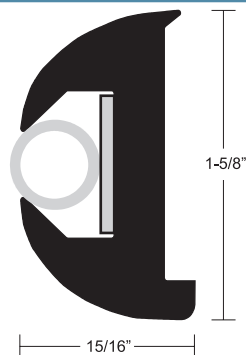

SEMI-RIGID VINYL

The best features of both rigid and flexible vinyl to provide an easily formed Rub Rail in one continuous coil.

SEMI-RIGID VINYL ACCEPTS FLEXIBLE INSERT

V11-9669

Insert: S11-4690

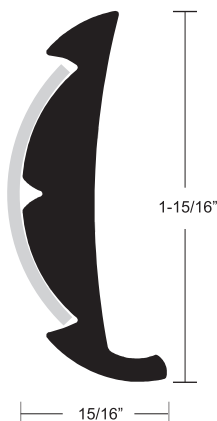

Part Number	Color	Length
V11-9669WHA100	Arctic White	100'

V21-9811

Insert: V12-9809 Flex Chrome

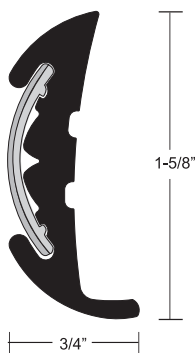

Part Number	Color	Length	Screw*
V21-9811WHD20D	Silver White	20'	#8

*Drilled and countersunk on 6" centers / sold separately



AVAILABLE as a RUB RAIL KIT (pg. 38)

SEMI-RIGID VINYL ACCEPTS FLEXIBLE INSERT

technical hotline 800.653.8568 • tacomarine.com

OVERLAY / INSERT

Stainless Steel or Rigid/Flexible Vinyl which can be installed separately or combined.

S11-450[▲]

Stainless Steel Type 304 Overlay

Part Number	Finish	Length	Screw*
S11-450SP12	Polished	12'	#6

**Drilled and countersunk on 6" centers / sold separately*

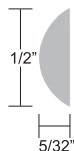

S11-451[▲]

Stainless Steel Type 316 Overlay

Part Number	Finish	Length	Screw*
S11-451SP12B	Polished	12'	#10

**Drilled and countersunk on 6" centers / sold separately*



S11-465[▲]

Stainless Steel Type 316 Overlay

Part Number	Finish	Length	Screw*
S11-465SP20B	Polished	20'	#12

**Drilled and countersunk on 6" centers / sold separately*



Ideal chafe protection...

TACO Marine's hollow back and solid back Stainless Steel overlays and inserts have other applications. They can be used as chafe protection for your boat with or without use of any extruded Rub Rails. They can also be a nice addition to any current flat face Rub Rail to provide a clean and updated look to your boat.

▲ Can also be used as an insert with certain Rub Rail profiles or used on its own as chafe or bumper protection

S11-467[▲]

Stainless Steel Type 316 Overlay

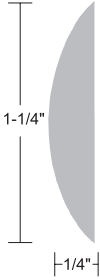

Part Number	Finish	Length	Screw*
S11-467SP20B	Polished	20'	#12

*Drilled and countersunk for 6" centers / sold separately

S11-469[▲]

Stainless Steel Type 316 Overlay

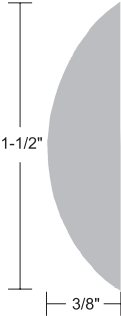

Part Number	Finish	Length	Screw*
S11-469SP20B	Polished	20'	#12

*Drilled and countersunk on 6" centers / sold separately

S11-4500

Stainless Steel Type 304 Insert

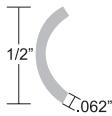

Part Number	Finish	Length	Screw*
S11-4500P12	Polished	12'	#8

*Drilled and countersunk on 6" centers / sold separately

S11-4511

Stainless Steel Type 304 Insert

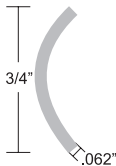

Part Number	Finish	Length	Screw*
S11-4511P12	Polished	12'	#8
S11-4511P16	Polished	16'	#8
S11-4511P20	Polished	20'	#8

*Drilled and countersunk on 6" centers / sold separately

▲ Can also be used as an insert with certain Rub Rail profiles or used on its own as chafe or bumper protection

S11-4650

Stainless Steel Type 304 Insert

Part Number	Finish	Length	Screw*
S11-4650P12	Polished	12'	#10

**Drilled and countersunk on 6" centers / sold separately*

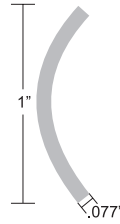

S11-4670

Stainless Steel Type 304 Insert

Part Number	Finish	Length	Screw*
S11-4670P12	Polished	12'	#10

**Drilled and countersunk on 6" centers / sold separately*

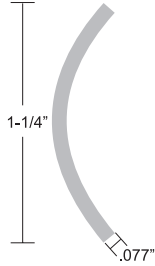

S11-4690

Stainless Steel Type 304 Insert

Part Number	Finish	Length	Screw*
S11-4690P12	Polished	12'	#10

**Drilled and countersunk on 6" centers / sold separately*

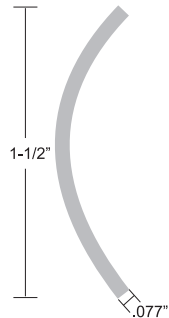

V22-3162

Sandwich Style Rigid Vinyl

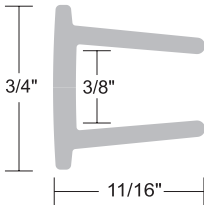

Part Number	Color	Length
V22-3162BKA12	Black	12'

V12-0003

Flexible Vinyl Fits Rub Rail: V11-2423, V11-3447, V11-4014

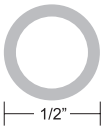

Part Number	Color	Length
V12-0003BKA50-1	Black	50'
V12-0003BKA70-1	Black	70'
V12-0003WHA50-1	Arctic White	50'
V12-0003WHA70-1	Arctic White	70'

V12-0005

Flexible Vinyl Fits Rub Rail: V11-0899, V11-3426

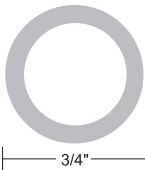

Part Number	Color	Length
V12-0005BKA50-1	Black	50'
V12-0005BKA70-1	Black	70'

V12-0303

Fits Rub Rail: A12-0303,
A12-0305, V21-9904

Part Number	Color	Length
V12-0303BKA50-1	Black	50'
V12-0303BKA70-1	Black	70'
V12-0303WHA50-1	Arctic White	50'
V12-0303WHA70-1	Arctic White	70'
V12-0303WHC50-1	Frosty White	50'
V12-0303WHC70-1	Frosty White	70'

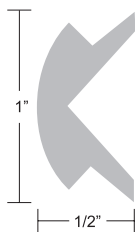

V12-0307

Flex Chrome

Part Number	Color	Length
V12-0307CP200	Chrome	200'

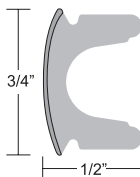

V12-0317

Fits Rub Rail: A11-0317

Part Number	Color	Length
V12-0317BKA50-1	Black	50'
V12-0317WHA50-1	Arctic White	50'



V12-0334

Part Number	Color	Length
V12-0334BKA50-1	Black	50'



V12-0338

Fits Rub Rail: A11-0638



Part Number	Color	Length
V12-0338BKA50-1	Black	50'
V12-0338BKA70-1	Black	70'

V12-0342

Fits Rub Rail: A11-0342

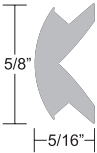

Part Number	Color	Length
V12-0342BKA50-1	Black	50'

V12-0810

Fits Rub Rail: V11-0809



Part Number	Color	Length
V12-0810BKA50-1	Black	50'

V12-1069

Flex Chrome

Fits Rub Rail: V21-9662



Part Number	Color	Length
V12-1069CP70-1	Chrome	70'
V12-1069CP165	Chrome	165'

V12-4144

Fits Rub Rail: V21-9678

Part Number	Color	Length
V12-4144BKA50-1	Black	50'
V12-4144BKA70-1	Black	70'

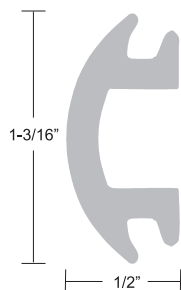

V12-4155

Fits Rub Rail: A11-0347

Part Number	Color	Length
V12-4155BKA50-1	Black	50'



V12-5818

Part Number	Color	Length
V12-5818BKA250	Black	250'

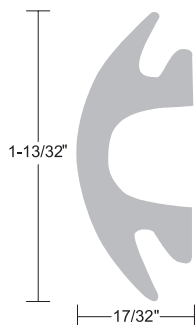

V12-9809

Flex Chrome

Fits Rub Rail: V21-9811, V21-9909

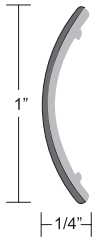

Part Number	Finish	Length
V12-9809CP210	Chrome	210'

V12-9814

Fits Rub Rail: V25-9815

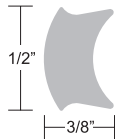

Part Number	Color	Length
V12-9814BKA250	Black	250'

ACCESSORIES

Enhancing a boat's Rub Rail adds value, attractive features and functionality.

Stiffener

Aluminum Flat Bar Stiffener

Part Number	Finish	Length	Screw
A40-0812AEY10D2	Mill	10'	#10

Use with flexible rub rail behind insert for smooth installation

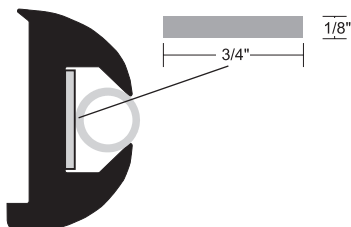

Recommended for V11-4014 Rub Rail (pg. 25) to avoid waves forming on Rub Rail due to the tightening of the screws.

Rub Strakes

Stainless Steel Type 304

Part Number	Length	Width	Screw
S11-1700P8	8"	3/4"	#8
S11-1700P12	12"	3/4"	#8
S11-1700P18	18"	3/4"	#8
S11-1700P24	24"	3/4"	#8
S11-1800P12	12"	1"	#10
S11-1800P18	18"	1"	#10
S11-1800P24	24"	1"	#10



Ideal chafe protection (pg. 27)...

Rail Ends

Stainless Steel Type 304

Part Number	Length	Width	Screw
S11-2000P12	12"	3/4"	#8
S11-2001P12	12"	1"	#10



Ideal chafe protection (pg. 27)...

End Caps

Stainless Steel & Nylon



F16-0039

F90-0001

F90-0002

F90-1870

Part Number	Color/Finish	Width	Screw
F16-0039	Stainless Steel	1-5/8"	#8
F90-0001BKN	Black Nylon	2"	#8
F90-0002BKN	Black Nylon	1-9/16"	#8
F90-1870BKA	Black Nylon	1-3/8"	#8

LED Navigation Lights

Stainless Steel Type 304

Rub Rail: V21-9659, V21-9904, V21-9909, V21-9959

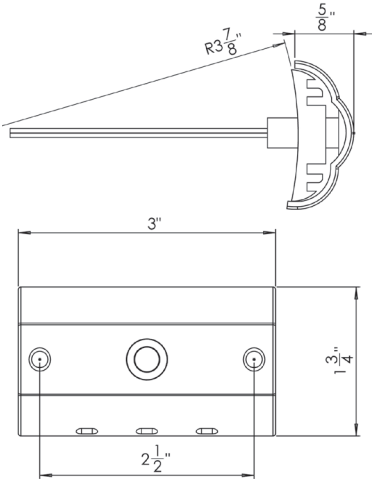

Part Number	Height	Amperes Draw	Voltage
F38-6600-1	1-3/4"	<.25	12-14V DC



Stainless Steel Type 304

Rub Rail: V21-9906

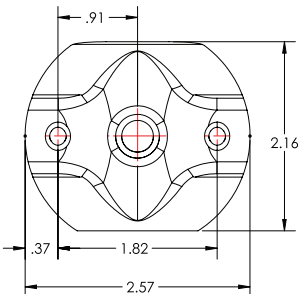

Part Number	Height	Amperes Draw	Voltage
F38-6700-1	2-5/32"	<.25	12-14V DC

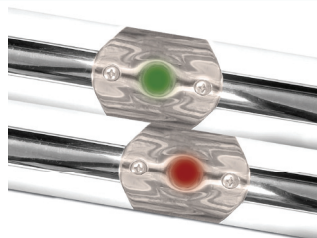

RUB RAIL KITS

All in one convenient and easy to carry box for Flexible & Semi-Rigid Rub Rails.

EASY TO INSTALL AND AVAILABLE IN MOST STORES

Kit includes:

Vinyl Rub Rail, Insert (if needed), End Caps, Stainless Steel Screws (Installation video available online at tacomarine.com)

- > Flexible Vinyl and Semi Rigid Rub Rail kits
- > Everything needed in one convenient box
- > New, easy-carry box
- > Grip-and-view packaging for a hands-on look at Rub Rail



V11-0809

Material: Flexible Vinyl

Insert: V12-0810

Part Number	Color	Length
V11-0809BBK50-2	Black/Black	50'
V11-0809BBK70-2	Black/Black	70'
V11-0809BWK50-2	Black/Arctic White	50'

Not to scale.
For accurate scaling see page 24.



V11-2423

Material: Flexible Vinyl

Insert: V12-0003

Part Number	Color	Length
V11-2423BBK50-2	Black/Black	50'
V11-2423BBK70-2	Black/Black	70'
V11-2423BWK50-2	Black/Arctic White	50'
V11-2423BWK70-2	Black/Arctic White	70'

Not to scale.
For accurate scaling see page 24.

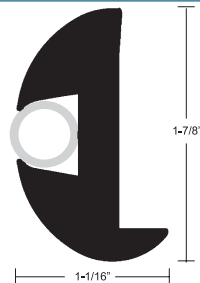

V11-3426

Material: Flexible Vinyl

Insert: V12-0005

Part Number	Color	Length
V11-3426BBK50-2	Black/Black	50'
V11-3426BBK70-2	Black/Black	70'
V11-3426BWK50-2	Black/Arctic White	50'
V11-3426BWK70-2	Black/Arctic White	70'

Not to scale.
For accurate scaling see page 25.

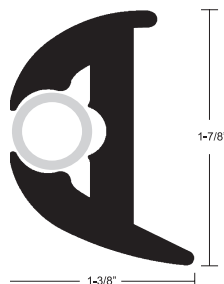

V11-3447

Material: Flexible Vinyl

Insert: V12-0003

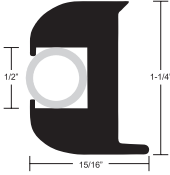

Not to scale.
For accurate
scaling see
page 25.

Part Number	Color	Length
V11-3447BBK50-2	Black/Black	50'
V11-3447BBK70-2	Black/Black	70'
V11-3447BWK50-2	Black/Arctic White	50'
V11-3447WWK50-2	Arctic White/Arctic White	50'

V11-4135

Material: Semi-Rigid Vinyl

No Insert

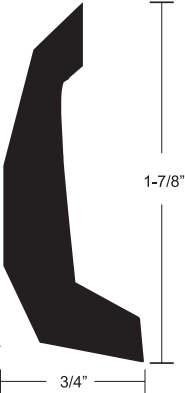

Shown to scale.

SOLD ONLY as a RUB RAIL KIT

Part Number	Color	Length
V11-4135BKA30-3	Black	30'

V11-9795

Material: Semi-Rigid Vinyl

Insert: V12-4144

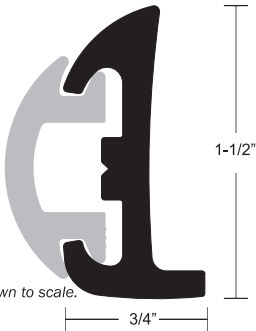

Shown to scale.

SOLD ONLY as a RUB RAIL KIT

Part Number	Color	Length
V11-9795BKA50D-1	Black	50'
V11-9795BBK50D-2	Black/Black	50'

V11-9811

Material: Semi-Rigid Vinyl
Insert: V12-9809 Flex Chrome

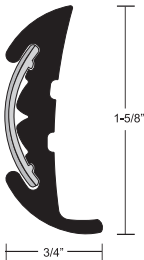

Not to scale.
For accurate
scaling see
page 26.

Part Number	Color	Length
V11-9811WCM70-2	Frosty White/Chrome	70'

Installation & More

REMOVAL OF OLD RUB RAIL & HULL PREPARATION

1. Remove the end caps.
2. Remove the insert and the stiffening strip (if there is one).
3. Remove the screws or rivets that attach the rub rail to the hull. If the rub rail is fastened with pop rivets, drill out the rivet head and push the shaft in, to prevent rattling.
4. Remove the rub rail.
5. Use a putty knife to scrape off any old sealant, being careful not to scratch the gel coat (it is unnecessary to remove all the old sealant, just the excess).
6. Fill all holes with sealant/3M 5200 (you will be drilling new holes for the new rub rail).
7. Let the sealant cure according to the manufacturers' suggestions.



Step 1



Step 2



Step 3



Step 4



Step 5



Step 6

CAUTION

If your rub rail comes coiled, stand in the center of the coil when cutting the straps so it unwinds away from you. Be prepared for quick movement of the coil.



Make it even more convenient by purchasing a Flexible and Semi-Rigid Rub Rail Kit complete with everything you'll need in an easy to carry box.

TIPS

- > To ensure a straight and consistent installation when installing Flexible Vinyl Rub Rail, it is best to stretch the rub rail during the installation process. Two people make this job much easier!
- > With Flexible Vinyl Rub Rail, the opening for the insert and fasteners may be narrower than the screw head. During installation, have something handy that can spread the opening until the screw head has passed the front opening.
- > **Use caution** - the drill chuck can damage the rub rail if it touches during drilling of the holes.
- > **Be careful** not to over-tighten the screws or the rub rail will pucker (wrinkle).

FLEXIBLE VINYL RUB RAIL INSTALLATION



1. Place masking tape above or below where the rub rail will go. Mark where the new holes are going to be located. Be sure to avoid the old filled holes. Space the holes a maximum of 6" apart. Note: this should be the first step in all rub rail installations.
2. Mark the midpoint of the rub rail with a piece of tape and soak the flexible rub rail in a tub of hot water (maximum 120 °F) or outside in the sun on the grass or pavement. Avoid sliding or dragging the rub rail on the pavement, as it will scratch. Either process should take at least 20 minutes to properly heat the rub rail.



Step 4

3. While it is warm, lay out the rub rail (following the gunwale of the boat) with the mark at the bow.
4. Drill 2 holes through the rub rail about 2" apart on one side of the bow and install the truss-head screws. Use silicone on the threads to create a water tight seal.



Step 5

5. With the two fasteners installed at the bow, go to the stern and stretch the rub rail by pulling it from the bow, towards the stern. Drill and install two screws at the stern position (this must be done while the rub rail remains warm and pliable).
6. Quickly do the same stretching and fastening procedure on the opposite side.
7. Install the rub rail along the transom and install a screw 1" back from the center line. Trim off the excess. Repeat the process on the other side (use a heat gun to bend on tight corners).
8. Go back to the bow and begin drilling the holes according to the marks you made on the masking tape. Put silicone on the threads and install the screws.
9. Repeat the process until the entire rub rail has been installed.
10. For installation of insert and end cap, please follow the instructions on page 44.



Step 8

SEMI-RIGID VINYL RUB RAIL INSTALLATION

This rub rail comes in complete 30' kits which include end caps, screws and is predrilled. The average boat requires two kits. When cutting, use a miter box to insure the rub rail you are installing has a straight end.

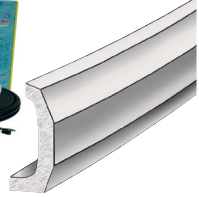

- Place masking tape above or below where the rub rail will go. Note: When a screw is properly installed into the hole, the screw head should sit just below the surface.
- Start in the middle of the transom, or if you are not going around the transom, start at the corner of the transom. Have a helper unroll about 4' of rub rail and take the curve out of it.
- Starting 12" from the end, drill through the predrilled rub rail holes into the boat, or drill and countersink the rub rail. Coat the screw threads with Silicone or 3M 5200 and install the screw.
- Continue uncoiling, straightening and drilling or drilling and countersinking. Coat the threads and work in one direction around the boat until you have installed the first coil. Leave the last 12" unfastened. We will finish this in step 8.
- When you have to bend the rub rail around a corner, move the heat gun back and forth to prevent overheating the rub rail.
- Straighten out about 4' of the next coil. Overlap the end of the last coil by 1/8" and attach the first screw approximately 12" from the end. Leave these two ends loose for now.
- Continue installing the rub rail until you come to where you started at the transom or at the corner of the transom leaving the last 12" unfastened. If you are ending the rub rail at the corner of the transom or motor well, you can now install the corner end caps.
- To make splices, pull the two sections towards you until they meet and push in until they snap into place. Drill through the rub rail and install a screw 1" & 6" from each end.
- For installation of insert and end cap, please follow the instructions on page 44.



Step 5

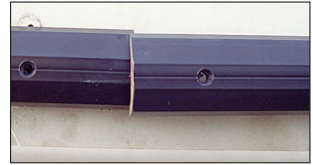

Step 6



Step 7

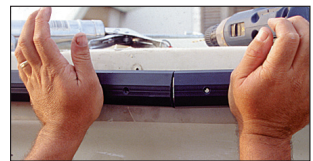

Step 8

TIPS

- > Once the rub rail comes in contact with the hull stop tightening the screw!
- > When making splices, make sure the ends are cut straight and smooth

RIGID VINYL RUB RAIL INSTALLATION

1. Place masking tape above or below where the rub rail will go and mark where the new holes should go.
2. Place the center of the first length at the bow. If there is a screw hole at the center, offset it 4" to one side. Check to see if any of the holes line up with a filled hole, slide the rub rail a couple of inches until all rub rail holes are clear of previous gunwale holes.
3. Press the rub rail against the hull and go back to one end. Leave the first two holes undrilled. Drill through the third pre-drilled hole. Coat the screw threads with Silicone or 3M 5200 and install the screw. Repeat this process until you reach the bow.
4. Bend the rub rail around the bow using a heat gun, moving it back and forth to prevent overheating or burning the rub rail.
5. Continue installing screws until you get to the other end of the rub rail. Leave the last two holes undrilled.
6. Start the next length by overlapping the previously installed length by 1/8" and begin attaching it leaving the first two holes undrilled. Complete installing this length leaving the last two holes undrilled.
7. Continue installing all the lengths until you reach the unfastened end of the first piece you installed at the bow, cutting it so it overlaps that piece by 1/8". Leave the last two holes undrilled.
8. Splices are made by pulling out on the two ends until they touch and pushing in so they snap into place, then install the screws. When installing heavier rub rail (like the V21-1025 or V21-1039) the ends are simply butted together without overlapping.
9. For installation of insert and end cap, please follow the instructions on page 44.

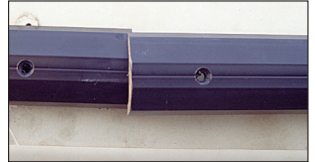

Step 6



Step 7

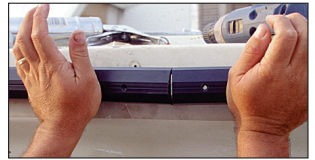

Step 8



Visit tacomarine.com for more product knowledge videos and installation videos.

ALUMINUM RUB RAIL INSTALLATION

Available in 12' and 20' lengths with holes pre-drilled every 6". Some aluminum rub rails incorporate vinyl inserts and others do not.

1. Place masking tape above or below where the rub rail will go and mark where the new holes should go.
2. Place the center of the first length on the bow. If a mounting hole is already there, move it to one side 3".
3. Press the rub rail against the hull until you come back to one end.
4. If any of the holes line up with the filled holes, try adjusting the rub rail a few inches one way or the other. Avoid a hole within two inches of either side of the bow.
5. Drill through the pre-drilled holes with a drill bit smaller than the screw.
6. Coat the threads with Silicone or 3M 5200 and install the screw.
7. Continue this process up to the bend at the bow.
8. Bend the rub rail around the bow by applying steady pressure with one hand while you lightly tap the rub rail with a rubber mallet where you want it to bend. Once bent remove insert and install screws.
9. Complete the installation of the rest of the rub rail.
10. Butt the next length up against the previously installed length. If a hole lines up with a filled hole, cut a few inches off the end in a miter box. This will change the location of the holes.
11. Continue this process until you come back to the other end of the length you installed at the bow. Measure the last length carefully so that it fits tightly and install the screws.
12. For installation of insert and end cap, please follow the instructions on page 44.



Step 6



Step 10

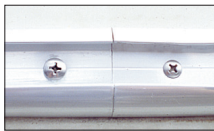

Step 11

STAINLESS STEEL RUB RAIL INSTALLATION

Stainless Steel offers the maximum durability, while maintaining a classic style. Stainless Steel rub rail is available in 304 and 316 grade in widths from 1/2" to 2" and in solid back and hollow back. All stainless steel rub rail is pre-drilled and countersunk. Depending on the style, these rub rails can be installed directly on the boat as a rub rail or as an overlap on rigid vinyl rub rail. Follow instructions same as aluminum (above) with the exception of the following:

1. When bending it around corners, use a rubber mallet to ensure a tight bend. stainless steel requires a lot more force to bend than aluminum.
2. Cutting the stainless steel rub rail is best done with a cut off wheel. If discoloration appears, polish it out with some rouge and a polishing wheel.
3. When used as an overlap, the mounting holes should be between the mounting screws of the rigid vinyl rub rail. When mounting to rigid vinyl rub rail, use short screws that do not penetrate the hull.

TIPS Aluminum

- > Have one person heat the rail and the other slowly bend it around and avoid forcing the material due to inadequate heat.
- > Before installing the rest of the rub rail, put it up in position and check to see if any pre-drilled holes line up with filled holes. You will be able to adjust the hole location by cutting off several inches from the end that butts up to the previously installed piece
- > Before bending, if the rub rail takes an insert, install about 6" of insert into the bend site to keep the channel from collapsing or losing shape during bending but do not cut it off the roll.

Stainless Steel

- > Thoroughly clean both sides of the stainless steel rub rail. Do not use cleaners with abrasives. **Be careful** - edges may be sharp!

INSERT INSTALLATION

There are three types of inserts. As indicated below, the first two must be heated in order to be installed. Install inserts beginning either at an end cap or at the transom.

Tubular

1. Using a heat gun, heat approximately 3' of insert until it compresses with a pinch.
2. Flatten the insert between your fingers and insert it into the rub rail until the heated section has been installed.
3. Repeat in maximum 3' increments until the entire insert has been installed.

V12-0303

1. Using a heat gun, heat approximately 2' of insert until it is hot to the touch.
2. Insert a few inches of the top leg into the rub rail.
3. Using a stiff putty knife, poke the bottom leg into the channel.
4. Repeat steps 2 & 3 until the heated section has been installed.
5. Heat the next 2' and repeat steps 2 through 4 until the entire insert has been installed.

Flexible Inserts

1. These inserts can be installed at room temperature.
2. Squeeze the insert between your fingers and insert it into the channel of the rub rail until the entire insert has been installed.
3. Tapping it with a rubber mallet will help set the insert. Inserts V12-0317 & V12-0334 need to be set by tapping it with a rubber mallet.

TIPS

> To avoid insert shrinkage, always screw down each end of flexible insert. The screws will be hidden from view once you install the end caps.

END CAP INSTALLATION

There are two types of end caps:

1. In-line end caps are installed on the same surface as the rub rail.
2. Corner end caps are used when a rub rail ends at the transom. Corner end caps are installed on the transom with the cap extending out the side to cap the rub rail.

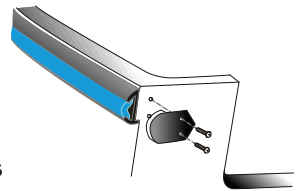

RUB STRAKES

Stainless steel are designed to screw down to the deck to prevent chafing of lines from anchors, dock fenders and mooring lines. These are very attractive and functional accessories and available in multiple widths and lengths from 8" - 24".



RUB ENDS

Stainless steel rail ends add a finished appearance to the ends of stainless steel rub rail. The rail end has a square cut edge designed to line up perfectly with the terminating end of the stainless steel rub rail, while the other end has a tapered finished look. Available in 3/4" and 1" width pre-drilled and countersunk screw holes.



TACO

MARINE



With over 50 years of experience, TACO Marine Is Your Choice For...

- Experience •

We build quality and durability into our products.
We are the #1 Rub Rail brand preferred by Boat Builders.
We provide the broadest range of Rub Rail solutions.

- Service •

You Talk, We Listen...
Our Sales Team and Customer Service organization are knowledgeable and responsive. We treat you like family.

- Quality Assurance •

We provide 5-year warranty on all our Rub Rail products.
We protect your investment by using UV inhibitors, color stabilizers and impact modifiers to ensure our Rub Rails are protected against constant exposure to maximize durability and color retention.

- Commitment •

“Total Customer Support” is how we operate at TACO Marine.
We offer product knowledge, installation instructions and tips, training videos and a selection of other helpful information on our website: tacomarine.com

Dealer:

TACO Metals, Inc.
Customer Service: 800.653.8568
email: info@tacomarine.com
Tech Hot Line: 800.653.8568
Fax: 800.653.8569



**FOLLOW US
ON FACEBOOK**



Part #X20-2002 09/17-3000